

LCD TV

Operating Instructions

Start-up Guide

Operating the TV

Using Optional Equipment

Using Menu Functions

Additional Information

BRAVIA

Introduction

Thank you for choosing this Sony product. Before operating the TV, please read this manual thoroughly and retain it for future reference. The illustrations used in this manual may differ depending on your TV model.

Location of the identification label

Labels for TV Model No. and Power Supply rating (in accordance with applicable safety regulation) are located on the rear of the TV. Labels for AC adapter Model No. and Serial No. are located at the bottom of AC adapter.

Notice for customers in South Africa

The Euro/South Africa converter plug should be fitted as follows.

- 1 Insert the power supply or CEE7 plug in to the converter plug.
- 2 Use an appropriate screwdriver to attach the screw tightly without damaging the screw head.
- 3 TEST: Grip the converter plug, and pull the VDE cord set/transformer to ensure it is fully secure, if not then increase the torque setting and further tighten. Re-test.
The converter plug is now ready for use.

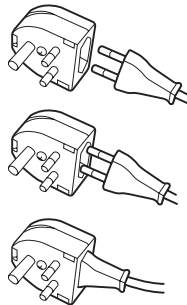

Disposal of the TV set



Disposal of Old Electrical & Electronic Equipment (Applicable in the European Union and other European countries with separate collection systems)

This symbol is on the remote control.

Disposal of the TV set



Disposal of Old Electrical & Electronic Equipment (Applicable in Republic of India)

India only

This symbol indicates that this product shall not be treated as household waste and may not be dropped in garbage bins. Product owners are advised to deposit their product at the nearest collection point for the recycling of electrical and electronic equipment. Your co-operation shall facilitate proper disposal & help prevent potential negative consequences/hazards to the environment and human health, which could otherwise be caused by inappropriate waste disposal including improper handling, accidental breakage, damage and/ or improper recycling of e-waste. The recycling of materials will help to conserve natural resources. For more detailed information about recycling of this product, please contact your local civic office, your household waste disposal service provider or the store where you made the purchase. You may contact our company's toll free number in India for assistance.

Trademark information

- HDMI, the HDMI Logo, and High-Definition Multimedia Interface are trademarks or registered trademarks of HDMI Licensing LLC in the United States and other countries.
- Manufactured under license from Dolby Laboratories. Dolby and the double-D symbol are trademarks of Dolby Laboratories.
- "BRAVIA" and BRAVIA are trademarks of Sony Corporation.
- MHL, Mobile High-Definition Link and the MHL Logo are trademarks or registered trademarks of MHL Licensing, LLC.

HDMI™
HIGH-DEFINITION MULTIMEDIA INTERFACE

DOLBY®
DIGITAL

MHL™
Mobile High-Definition Link

Table of Contents

Start-up Guide

Checking the accessories.....	4
1: Attaching the Table-Top Stand	4
2: Connecting an antenna/cable/VCR.....	4
3: Preventing the TV from toppling over.....	5
4: Performing the initial set-up.....	5
Detaching the Table-Top Stand from the TV.....	5
Safety information.....	6
Precautions	7

Operating the TV

Overview of the remote	8
Overview of the TV controls and indicators.....	9

Using Optional Equipment

Viewing pictures from the connected equipment	10
Using MHL function.....	11

Using Menu Functions

Photo Frame Mode.....	12
Favourites.....	12
Photo/Music/Video	13
FM Radio (except KLV-40EX43B, KLV-32EX33B).....	14
Settings	15
Picture	15
Sound.....	16
Screen.....	17
Channel Set-up	18
Parental Lock	19
Set-up.....	19
Eco	20

Additional Information

Installing the accessories (Wall-Mount Bracket)	21
TV installation dimensions table.....	21
Screw and hook locations diagram/table	22
Troubleshooting	23
Specifications.....	Back cover

- Before operating the TV, please read “Safety information” (page 6). Retain this manual for future reference.
- Instructions about “Installing Wall Mount Bracket” are included within this TV’s instructions manual.

Start-up Guide

Checking the accessories

Table-Top Stand (1)

Fixing screws for Table-Top Stand (2)

Remote (1)

AC power cord (1)

AC adapter (1)

Cable holders (2)

Size AA batteries (R6 type) (2)

■ To insert batteries into the remote

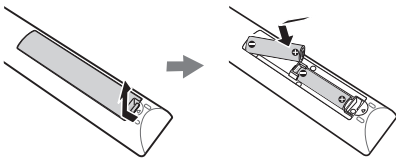

1: Attaching the Table-Top Stand

- For best picture quality, do not expose the screen to direct illumination or sunlight.
- If using an electric screwdriver, set the tightening torque at approximately 1.5 N·m (15 kgf·cm).

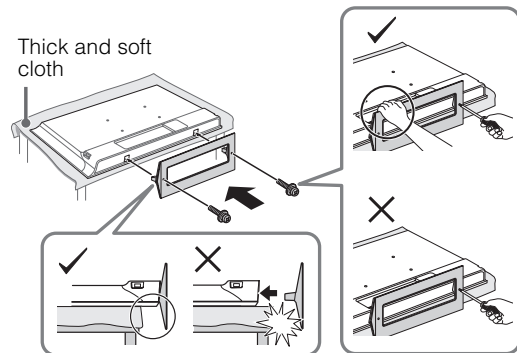
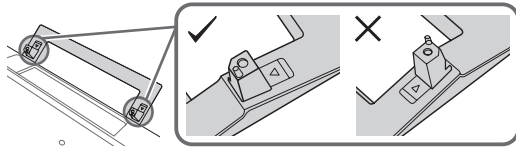

2: Connecting an antenna/cable/VCR

Connecting an antenna/cable

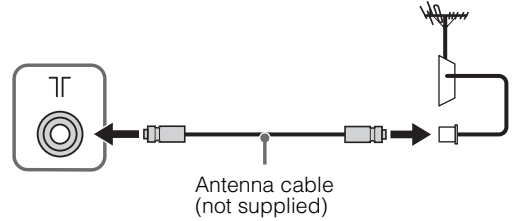

Connecting an antenna/cable and VCR

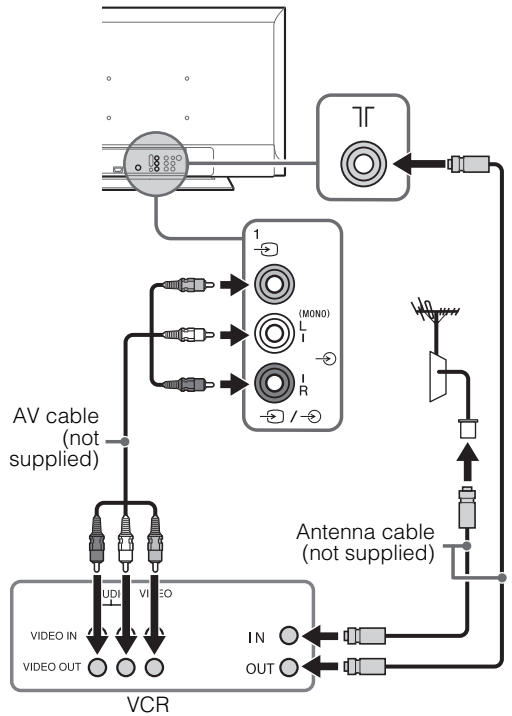

3: Preventing the TV from toppling over

*Anchor bolts (M6 / M4) (not supplied)

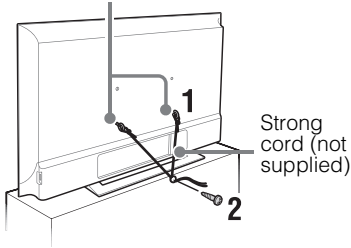

OR

*Anchor bolts (M6 / M4) (not supplied)

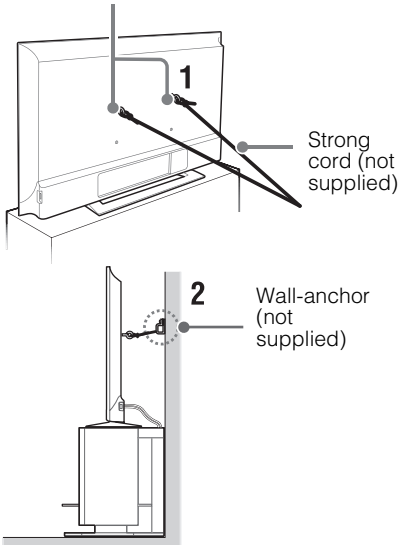

* KLV-40EX430, KLV-40EX43A, KLV-40EX43B :
Use M6 anchor bolts
KLV-32EX330, KLV-32EX33A, KLV-32EX33B :
Use M4 anchor bolts

4: Performing the initial set-up

1

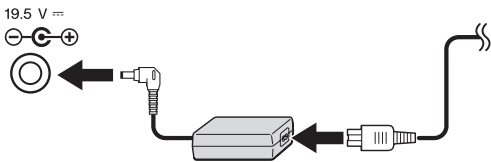

- When the TV is in standby mode (the (standby) indicator on the TV front panel is red), press on the remote to turn on the TV.
- Make sure that the TV is completely turned off before unplugging the AC power cord or DC cable. Unplugging the AC power cord or DC cable while the TV is turned on may cause the TV to malfunction.

2



Follow the instructions on the screen.

- You can also tune channels manually (page 18).
- Language options vary depending on model.
- Select "Home" from "Location" for the best TV settings to use the TV in the home.

Detaching the Table-Top Stand from the TV

- Do not remove the Table-Top Stand for any reason other than to wall-mount the TV.

Thick and soft cloth

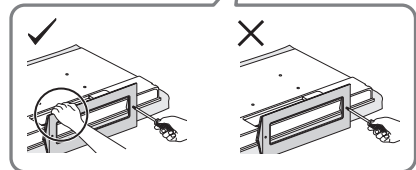
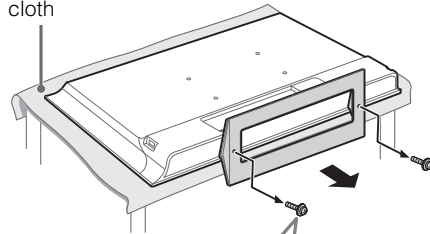

To bundle the AC adapter

- You can bundle the AC adapter as an optional step. Do not bundle it for any reason other than to wall-mount the TV.
- Make sure that the label is facing outwards when bundling AC adapter.

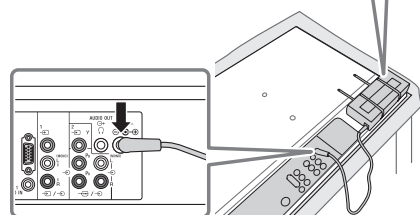
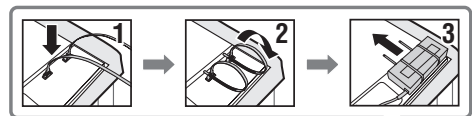

Safety information

WARNING

Batteries must not be exposed to excessive heat such as sunshine, fire or the like.

Installation/Set-up

Install and use the TV set in accordance with the instructions below in order to avoid any risk of fire, electrical shock or damage and/or injuries.

Installation

- The TV set should be installed near an easily accessible AC power outlet.
- Place the TV set on a stable, level surface to avoid it from falling down and cause personal injury or damage to the TV.
- Only qualified service personnel should carry out wall installations.
- For safety reasons, it is strongly recommended that you use Sony accessories, including:
 - Wall-Mount Bracket
SU-WL50B (KLV-40EX430, KLV-40EX43A, KLV-40EX43B)
SU-WL100 (KLV-32EX330, KLV-32EX33A, KLV-32EX33B)
- Be sure to use the screws supplied with the Wall-mount bracket when attaching the mounting hooks to the TV set. The supplied screws are designed as indicated by illustration when measured from the attaching surface of the mounting hook. The diameter and length of the screws differ depending on the Wall-mount bracket model. Use of screws other than those supplied may result in internal damage to the TV set or cause it to fall, etc.

32" TV: 6.5 mm ~ 10 mm
40" TV: 8 mm ~ 12 mm

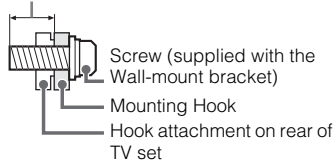

Transporting

- Before transporting the TV set, disconnect all cables.
- Two or more people are needed to transport a large TV set.
- When transporting the TV set by hand, hold it as shown in the illustration. Do not put stress on the LCD panel and the frame around the screen.
- When transporting the TV set, do not subject it to jolts or excessive vibration.

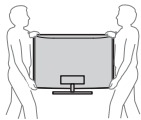

- When transporting the TV set for repairs or when moving, pack it using the original carton and packing material.

Ventilation

- Never cover the ventilation holes or insert anything in the cabinet.
- Leave space around the TV set as shown below.
- It is strongly recommended that you use a Sony wall-mount bracket in order to provide adequate air-circulation.

Installed on the wall

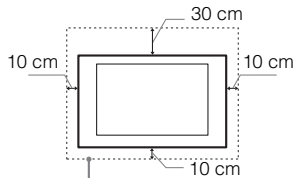

Leave at least this space around the set.

Installed with stand

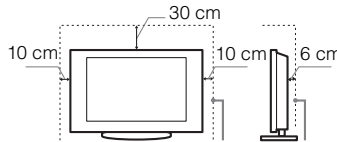

Leave at least this space around the set.

- To ensure proper ventilation and prevent the collection of dirt or dust:
 - Do not lay the TV set flat, install upside down, backwards, or sideways.
 - Do not place the TV set on a shelf, rug, bed or in a closet.
 - Do not cover the TV set with a cloth, such as curtains, or items such as newspapers, etc.
 - Do not install the TV set as shown below.

Air circulation is blocked.

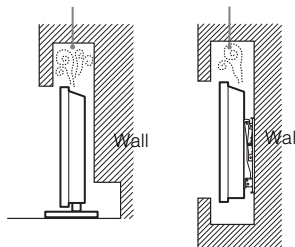

AC power cord

Handle the AC power cord and outlet as follows in order to avoid any risk of fire, electrical shock or damage and/or injuries:

- Use only Sony supplied AC power cords, not those of other brands.
- Insert the plug fully into the AC power outlet.
- Operate the TV set on a 110-240 V AC supply only.

- When wiring cables, be sure to unplug the AC power cord for your safety and take care not to catch your feet on the cables.
- Disconnect the AC power cord from the AC power outlet before working on or moving the TV set.
- Keep the AC power cord away from heat sources.
- Unplug the AC power plug and clean it regularly. If the plug is covered with dust and it picks up moisture, its insulation may deteriorate, which could result in a fire.

Notes

- Do not use the supplied AC power cord on any other equipment.
- Do not pinch, bend, or twist the AC power cord excessively. The core conductors may be exposed or broken.
- Do not modify the AC power cord.
- Do not put anything heavy on the AC power cord.
- Do not pull on the AC power cord itself when disconnecting the AC power cord.
- Do not connect too many appliances to the same AC power outlet.
- Do not use a poor fitting AC power outlet.

NOTE ON AC adapter Warning

To reduce the risk of fire or electric shock, do not expose this apparatus to rain or moisture.

To prevent fire or shock hazard, do not place objects filled with liquids, such as vases, on the apparatus.

Do not install this equipment in a confined space, such as a bookshelf or similar unit.

- Please ensure that the AC power outlet is installed near the equipment and shall be easily accessible.
- Be sure to use the supplied AC adapter and AC power cords. Otherwise it may cause a malfunction.
- Connect the AC adapter to an easily accessible AC power outlet.
- Do not coil the AC power cord around the AC adapter. The core wire may be cut and/or it may cause a malfunction of the TV.
- Do not touch the AC adapter with wet hands.
- If you notice an abnormality in the AC adapter, disconnect it from the AC power outlet immediately.
- The set is not disconnected from the AC source as long as it is connected to the AC power outlet, even if the set itself has been turned off.

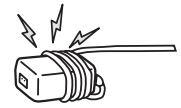

Prohibited Usage

Do not install/use the TV set in locations, environments or situations such as those listed below, or the TV set may malfunction and cause a fire, electrical shock, damage and/or injuries.

Location:

- Outdoors (in direct sunlight), at the seashore, on a ship or other vessel, inside a vehicle, in medical institutions, unstable locations, near water, rain, moisture or smoke.
- If the TV is placed in the changing room of a public bath or hot spring, the TV may be damaged by airborne sulfur, etc.



Environment:

- Places that are hot, humid, or excessively dusty; where insects may enter; where it might be exposed to mechanical vibration, near flammable objects (candles, etc). The TV set shall not be exposed to dripping or splashing and no objects filled with liquids, such as vases, shall be placed on the TV.
- Do not place the TV in a humid or dusty space, or in a room with oily smoke or steam (near cooking tables or humidifiers). Fire, electric shock, or warping may result.
- Do not install the TV in places subject to extreme temperature such as in direct sunlight, near a radiator or a heating vent. The TV may overheat in such condition which can cause deformation of the enclosure and/or TV malfunction.



Situation:

- Do not use when your hands are wet, with the cabinet removed, or with attachments not recommended by the manufacturer. Disconnect the TV set from AC power outlet and antenna during lightning storms.
- Do not install the TV so that it sticks out into an open space. Injury or damage from a person or object bumping into the TV may result.



Broken pieces:

- Do not throw anything at the TV set. The screen glass may break by the impact and cause serious injury.
- If the surface of the TV set cracks, do not touch it until you have unplugged the AC power cord. Otherwise electric shock may result.

When not in use

- If you will not be using the TV set for several days, the TV set should be disconnected from the AC power for environmental and safety reasons.

- As the TV set is not disconnected from the AC power when the TV set is just turned off, pull the plug from the AC power outlet to disconnect the TV set completely.
- However, some TV sets may have features that require the TV set to be left in standby to work correctly.

For children

- Do not allow children to climb on the TV set.
- Keep small accessories out of the reach of children, so that they are not mistakenly swallowed.

If the following problems occur...

Turn off the TV set and unplug the AC power cord immediately if any of the following problems occur. Ask your dealer or Sony service centre to have it checked by qualified service personnel.

When:

- AC power cord is damaged.
- Poor fitting of AC power outlet.
- TV set is damaged by being dropped, hit or having something thrown at it.
- Any liquid or solid object falls through openings in the cabinet.

About LCD Monitor Temperature

When the LCD Monitor is used for an extended period, the panel surrounds become warm. You may feel hot when touching there by the hand.

Precautions

Viewing the TV

- View the TV in moderate light, as viewing the TV in poor light or during long period of time, strains your eyes.
- When using headphones, adjust the volume so as to avoid excessive levels, as hearing damage may result.

LCD Screen

- Although the LCD screen is made with high-precision technology and 99.99% or more of the pixels are effective, black dots may appear or bright points of light (red, blue, or green) may appear constantly on the LCD screen. This is a structural property of the LCD screen and is not a malfunction.
- Do not push or scratch the front filter, or place objects on top of this TV set. The image may be uneven or the LCD screen may be damaged.
- If this TV set is used in a cold place, a smear may occur in the picture or the picture may become dark. This does not indicate a failure. These phenomena disappear as the temperature rises.

- Ghosting may occur when still pictures are displayed continuously. It may disappear after a few moments.
- The screen and cabinet get warm when this TV set is in use. This is not a malfunction.
- The LCD screen contains a small amount of liquid crystal. Follow your local ordinances and regulations for disposal.

Handling and cleaning the screen surface/cabinet of the TV set

Be sure to unplug the AC power cord connected to the TV set from AC power outlet before cleaning.

To avoid material degradation or screen coating degradation, observe the following precautions.

- To remove dust from the screen surface/cabinet, wipe gently with a soft cloth. If dust is persistent, wipe with a soft cloth slightly moistened with a diluted mild detergent solution.
- Never spray water or detergent directly on the TV set. It may drip to the bottom of the screen or exterior parts and enter the TV set, and may cause damage to the TV set.
- Never use any type of abrasive pad, alkaline/acid cleaner, scouring powder, or volatile solvent, such as alcohol, benzene, thinner or insecticide. Using such materials or maintaining prolonged contact with rubber or vinyl materials may result in damage to the screen surface and cabinet material.
- Periodic vacuuming of the ventilation openings is recommended to ensure to proper ventilation.
- When adjusting the angle of the TV set, move it slowly so as to prevent the TV set from moving or slipping off from its table stand.



Optional Equipment

Keep optional components or any equipment emitting electromagnetic radiation away from the TV set. Otherwise picture distortion and/or noisy sound may occur.

(Caution about handling the remote control)

Notes

- Observe the correct polarity when inserting batteries.
- Do not use different types of batteries together or mix old and new batteries.
- Dispose of batteries in an environmentally friendly way. Certain regions may regulate the disposal of batteries. Please consult your local authority.
- Handle the remote with care. Do not drop or step on it, or spill liquid of any kind onto it.
- Do not place the remote in a location near a heat source, a place subject to direct sunlight, or a damp room.

Operating the TV

Overview of the remote

Selects input source.
In Text mode: Holds the current page.

Operates the BRAVIA Sync and USB compatible equipment that is connected to the TV.

Displays a photo, clock, calendar and listen to music at the same time.

Selects, adjusts or confirmed selected items.

Returns to the previous screen.
In USB mode: Stops the playback.

Displays or cancels the menu.

Exit Text mode, or switches to a TV display when displaying external input.

View Twin Picture and PIP (page 9).

In TV mode: Selects channels.
In Text mode: Selects pages.

Displays text information.

Adjusts volume.

Mute or restore sound.

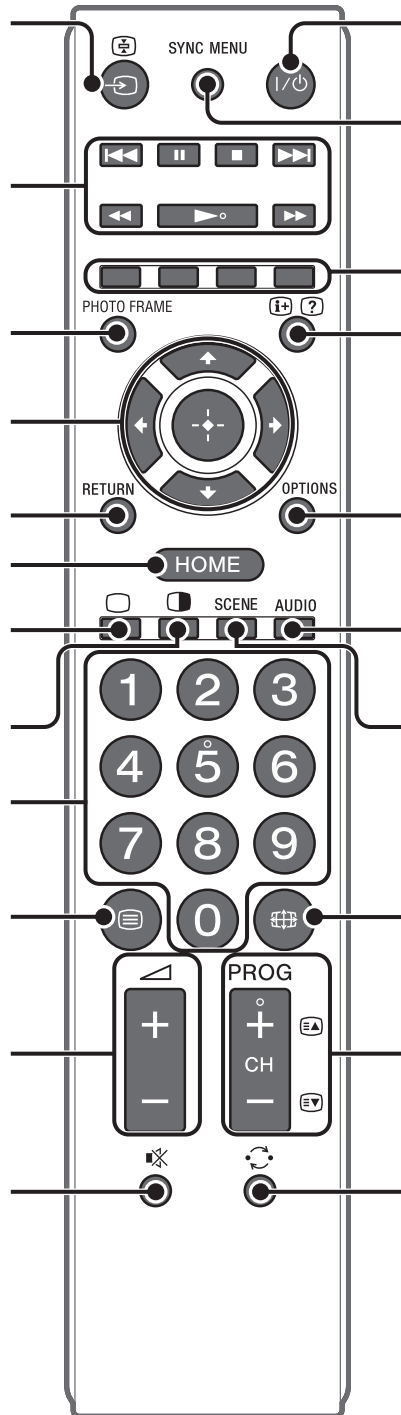

Turns the TV on or switch to standby mode.

Displays the BRAVIA Sync Menu and then select connected HDMI/MHL equipment from "Device Selection".

Available when operation guide appears on the screen.

Displays information about the programme/input or reveals hidden information in Text mode.

Displays a list of shortcuts to some setting menus.

Dual Sound (page 16).

Selects desired scene modes from the "Scene Select" menu.

Selects the desired wide mode (page 9).

In TV mode: Selects the next or previous channel.
In Text mode: Selects the next or previous page.

Returns to the previous channel or input watched (for more than 15 seconds).

■ To change the Wide Mode

For TV, Video, Component or HDMI (except PC input)/MHL

PC or HDMI PC Input (PC timing)

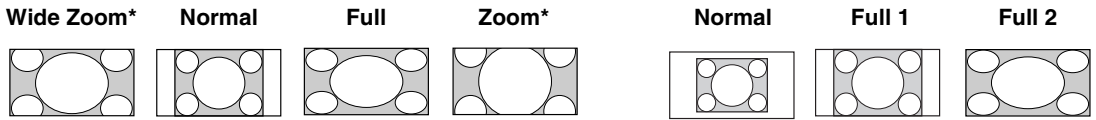

* Parts of the top and bottom of the picture may be cut off.

🔧 • Some options may not be available depending on the signal source.

■ To view Twin Picture and PIP (Picture in Picture)

Twin Picture Availability	
In Main Window	In Sub Window
Component	TV programme or Video 1
HDMI 1/MHL or HDMI 2 (except PC input mode)	TV programme or Video 1/2

PIP Availability	
In Main Window	In Sub Window
PC	TV programme or Video 1/2
HDMI 1/MHL or HDMI 2 (PC timing)	

To return to single picture mode: ⏪ (Twin Picture only)/⏩/RETURN/“Single Picture” from Options menu.

- 🔧 • In sub window, you can select the TV channel or video input by pressing **OPTIONS** and select “Sub-window”.
- You cannot change the size of the pictures.
 - Picture smoothness may decrease when picture size reduce.

Overview of the TV controls and indicators

Front View

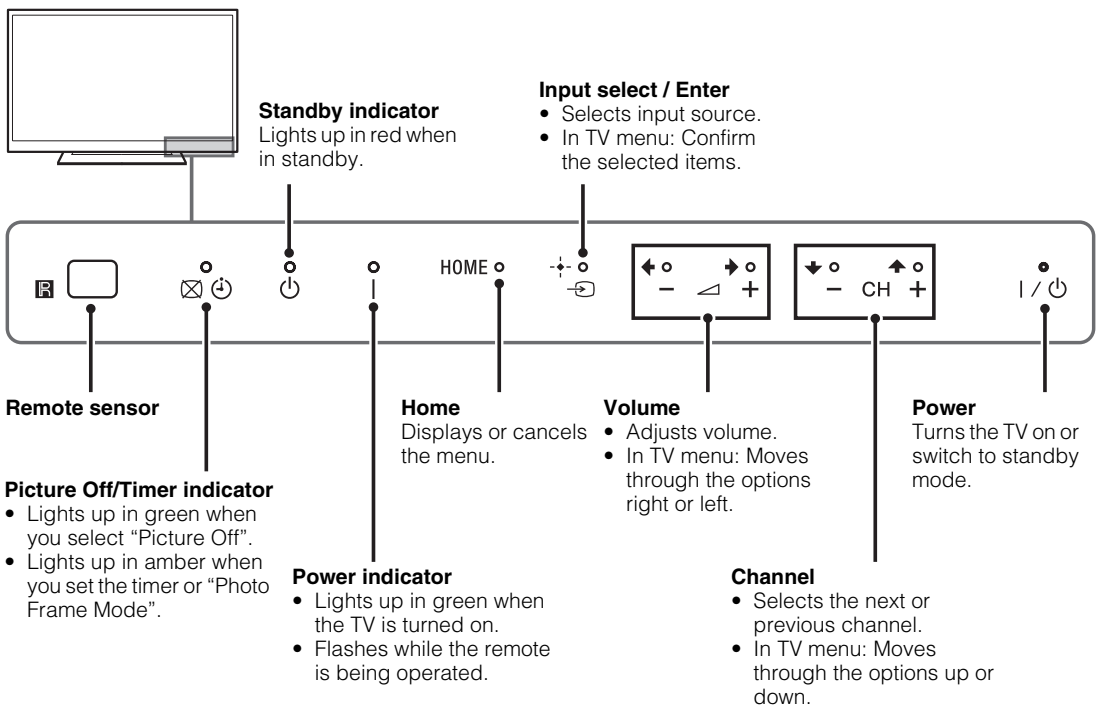

🔧 • Do not put anything over the sensor, doing so may affect its function.

Using Optional Equipment

Viewing pictures from the connected equipment

Turn on the connected equipment, then press or on the TV to display the connected equipment list.

Rear View

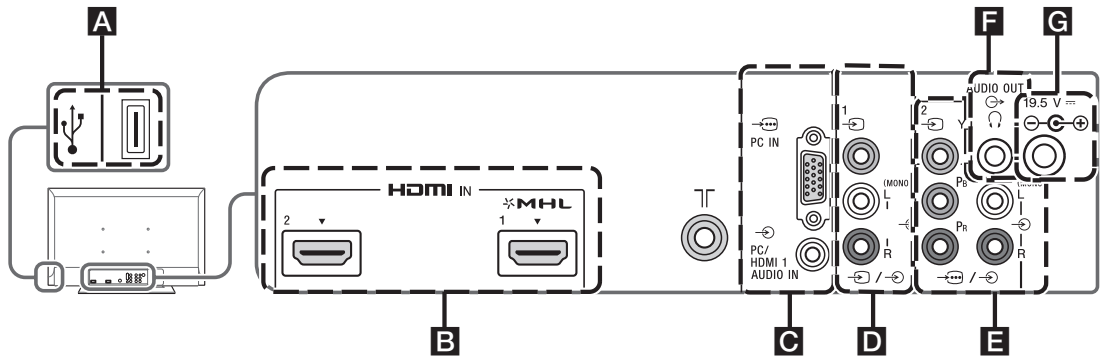

A (Digital still camera, Camcorder, USB storage media)

Access photo/music/video files stored on a USB device (page 13).

B **HDMI IN 1/MHL or HDMI IN 2 (Home Theatre systems, Camcorder, Blu-ray Disc player, DVD player, PC with HDMI output and Mobile device)**

Connect to the HDMI IN 1/MHL or HDMI IN 2 jack if the equipment has an HDMI jack. If the equipment has a DVI jack, connect the DVI jack to the HDMI IN 1/MHL jack through a DVI - HDMI adapter interface (not supplied), and connect audio out jack of the equipment to the PC/HDMI 1 AUDIO IN jack. If the equipment is compatible with MHL, connect the MHL jack of the equipment to the HDMI IN 1/MHL jack through a MHL - HDMI cable (not supplied).

- The HDMI jacks can support PC timing in HDMI PC mode. See page 17 for supported PC input signal.
- Be sure to use only an authorized HDMI cable bearing the HDMI logo, or an authorized MHL cable bearing the MHL logo.

C **PC IN or PC/HDMI 1 AUDIO IN (PC)**

Connect to the PC IN jack and the PC/HDMI 1 AUDIO IN. It is recommended to use a PC cable with ferrite core.

D 1/ 1 **(DVD player, VCR, Video game equipment, S VHS/ Hi8/ DVC camcorder)**

Connect to the video jack 1 and the audio jacks 1. If you connect mono equipment, connect to the L (MONO) jack .

E 1/ 2 or 2 **(DVD player with component output)**

Connect to the component jacks and the audio jacks 1/ 2. For better picture quality, component connection is recommended if your DVD player has a component video output. When using the component video jack 1 as the video jack 2 select "Video 2" in the "Video 2/Component Input" menu (page 20).

F **AUDIO OUT (Headphone)**

Connect with an audio cable or headphones. You can listen to TV sound through your stereo system or headphones. You can select "Variable" or "Fixed" in the "Audio Out" menu (page 16).

G 19.5V

Connect AC adapter to the 19.5V jack.

Using MHL function

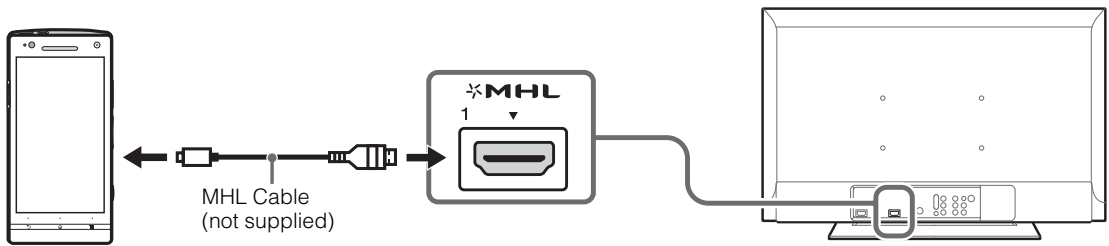

The MHL (Mobile High-Definition Link) enables the TV to communicate with connected MHL-compatible device. When connecting MHL-compatible device, TV simultaneously charges the connected device while playing photo/music/video from it. You can use the TV remote control to control the connected MHL-compatible device.

- If “Auto Input Change (MHL)” is set to “On” (page 20), the TV automatically switches to MHL mode when MHL-compatible device is connected to HDMI IN 1/MHL jack. The availability of “Auto Input Change(MHL)” depends on whether the MHL-compatible device can support this feature.
- You can continue normal usage of the connected MHL-compatible device (such as receiving calls) depending on its capability.
- Some remote functions may not be available depending on features of the connected MHL-compatible device. Please refer to the device manual for details.
- You can continue charging the MHL-compatible device even when the TV is in standby mode.
- This product is officially MHL-certified for guaranteed operation with other MHL-certified devices. If you encounter any problems when using the MHL function, please consult the device manufacturer for support.

Using Menu Functions

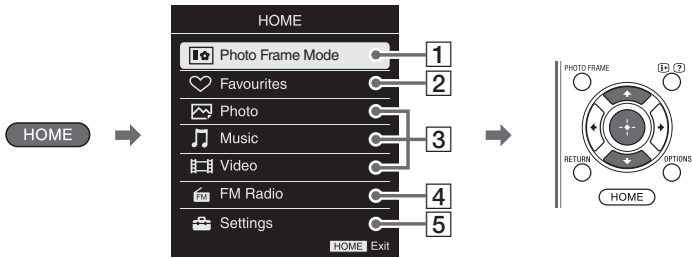

- To exit Home menu: **HOME**

1 Photo Frame Mode

Display Photo, Music and Clock/calendar at the same time.

■ To enter Photo Frame Mode

- 1 **PHOTO FRAME** OR
- 2 **HOME** → “Photo Frame Mode” OR
- 3 **HOME** → “Settings” → “Set-up” → “Photo Frame Settings” → “Image Selection”/“Music Selection”

-  • To exit Photo Frame mode: **HOME** / **RETURN** / **PHOTO FRAME**

2 Favourites

Store up to 10 channels or external inputs.

■ To add a current channel or external inputs into Favourites list

- 1 **HOME** → “Favourites” → “Add to Favourites” OR
- 2 **OPTIONS** → “Add to Favourites”

■ To watch a channel or external input



-  • To exit Favourites List: **RETURN**
- When you run the “Auto Tuning”, only the programme channels in your Favourites list will be cleared.

3 Photo/ Music/ Video

Playback photo/music/video files via USB devices.

Side View



- If more than one USB detected:  → “Device Selection”
- If you connect the USB device when “USB Auto Start” is set to “On” (page 19), the thumbnail view of the last played photo/music/video appears automatically.

■ To adjust the picture and sound setting (Video)

When playing video →  → “Picture” / “Sound”

■ To play a photo as slideshow (Photo)

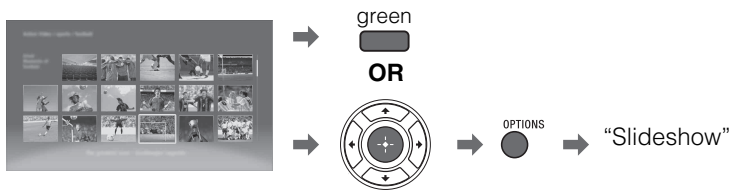

 → “Stop Slideshow”

- While the TV is accessing the data on the USB device, do not turn off the TV or connected USB device, disconnect the USB cable, or remove the USB device.
- Sony will not be held liable for any damage to, or loss of, data on the recording media due to a malfunction of any connected devices or the TV.
- The file name and folder name may not display correctly in some cases.
- When you connect a Sony digital still camera, set the camera's USB connection mode to Auto or Mass Storage. For more information about USB connection mode, refer to the instructions supplied with your digital camera.
- Check the website below for updated information about compatible USB devices.
<http://www.sony-asia.com/bravia/flash.html>
- Use a USB storage device that is compliant with USB mass storage device class standards.

USB Video format

Extension	Container	Video Codec	Audio Codec
.avi	AVI	XviD, MPEG1, MPEG2 MP, H.264 BP/MP/HP, MPEG-4 SP/ASP	PCM / MPEG1 Layer1, 2 / MP3 / AAC-LC, PS, SBR/ Dolby Digital (2ch) / WMA v8
.wmv, .asf	ASF	WMV v9, XviD, MPEG-4 SP/ASP, VC-1	MP3 / WMA v8
.mp4, .mov, .3gp	MP4	H.264 BP/MP/HP, MPEG-4 SP/ASP, H.263, Motion JPEG	MPEG1 Layer1, 2 / MP3/AAC-LC, PS, SBR
.mkv	MKV	H.264 BP/MP/HP, MPEG-4 SP/ASP, WMV v9, VC-1	PCM / MPEG1 Layer1, 2 / MP3 / AAC-LC, PS, SBR/ Dolby Digital (2ch) / WMA v8
.mpg, .mpeg	PS	MPEG1, MPEG2 MP	MPEG1 Layer1, 2 / MP3 / Dolby Digital (2ch)
.ts, .mts, .m2ts	TS	MPEG2 MP, VC-1, H.264 BP/MP/HP	MPEG1 Layer1, 2 / MP3 / AAC-LC, PS, SBR

Continued

USB Music format

Extension	Audio Codec
.mp3	MP3
.wma	WMA v8
.wav	WAV
.m4a	MP4

USB Photo format

Extension	Image Codec
.jpg, .jpeg	JPEG

DCF2.0 or EXIF2.21 supported.

- Playback of the above file formats is not guaranteed.
- The USB device supports FAT16 , FAT32 and NTFS.

4 FM Radio (except KLV-40EX43B, KLV-32EX33B)

- For first time using FM Radio function:
 → "Settings" → "Channel Set-up" → "FM Radio Set-up" → "Auto Tuning" (page 18)
- To access FM Radio mode
 → "FM Radio"



■ To listen to preset stations:

- 1 In FM Radio mode →  → "Settings" → "Channel Set-up" → "FM Radio Set-up" (page 18)

OR

- 2 In FM Radio mode →  → "FM Radio Presets"

- To exit "Channel Set-up" menu: 

- To select desired preset FM Radio stations:  

■ To listen to non-preset stations:

To search desired station

To tune FM frequency

In FM Radio mode →



/



- If "Please set-up FM Radio." appears, perform 1 in "To listen to preset stations".

■ To show photo or picture while listening to FM Radio



In FM Radio mode →  → "Photo Frame Mode"

- To exit "Photo Frame Mode": 



■ To reduce power consumption in FM Radio

- 1  → "Power Saving" OR

- 2  → "Settings" → "Eco" → "Power Saving"

- To exit from "Picture Off": Any key except ,  or 

- To exit FM Radio mode: 

- If the station has a noisy sound, press  to improve the sound quality.
- If the FM stereo programme has static noise, press  until "Mono" appears to reduce noise.

5 Settings

-  • The options you can adjust vary depending on the situation. Unavailable options are greyed out or not displayed.



Picture

Picture Mode	Sets a picture mode. The options that can be selected differ depending on the “Scene Select” settings.
Reset	Resets all the “Picture” settings except “Picture Mode” and “Intelligent Picture Plus Set-up” to the factory settings.
Backlight	Adjusts the brightness of the backlight.
Picture	Increases or decreases picture contrast.
Brightness	Brightens or darkens the picture.
Colour	Increases or decreases colour intensity.
Hue	Increases or decreases the green tones and red tones.
Sharpness	Sharpens or softens the picture.
Colour Temperature	Adjusts the whiteness of the picture.
Noise Reduction	Reduces the picture noise (snowy picture) in a weak broadcast signal.
MPEG Noise Reduction	Reduces the picture noise in MPEG-compressed video.
Cinema Drive	Provides improved picture movement when playing BD (Blu-ray Disc), DVD or VCR images taken on film, reducing picture blur and graininess. Select “Auto” to represent original film-based content.  • If the image contains irregular signals or too much noise, “Cinema Drive” is automatically turned off even if “Auto” is selected.
Advanced Settings	Set “Picture” settings in more detail. “ Reset ”: Resets all the advanced settings to the factory settings. “ Adv. Contrast Enhancer ”: Automatically adjusts “Backlight” and “Picture” to the most suitable settings judging from the brightness of the screen. This setting is especially effective for dark images scenes, and will increase the contrast distinction of the darker picture scenes. “ Black Corrector ”: Enhances black areas of the picture for stronger contrast. “ Gamma ”: Adjusts the balance between bright and dark areas of the picture. “ Clear White ”: Emphasises white colours. “ Live Colour ”: Makes colours more vivid. “ LED Motion Mode ”: Provides smoother picture movement.
Intelligent Picture Plus Set-up	“ Intelligent Picture Plus ”: Improves the picture when viewing TV programme or video input. “ Signal Level Indicator ”: Turns on/off the “Signal Level Indicator” feature. When “On” is selected, the signal level bar will be displayed when you select a channel or video input. “ Picture Optimisation ”: Enhances the picture to your preferred settings.

Sound

Sound Mode	Sets a sound mode. The options that can be selected differ depending on the "Scene Select" settings.
Reset	Resets all the "Sound" settings except "Sound Mode", "Dual Sound", "Speakers", "Audio Out" and "HDMI/DVI Audio Source" to the factory settings.
7 Band Equalizer	Adjusts sound frequency settings.
Balance	Emphasises left or right speaker balance.
Intelligent Volume	Minimizes the difference in volume level between all programmes and adverts (e.g. adverts tend to be louder than programmes).
Volume Offset	Adjusts the volume level of the current input relative to other inputs.
Surround	Selects the suitable surround effects depending on the genre of TV programme (movie, sport, music, etc.) or video game.
Bass Booster	Produces a fuller sound for more impact, by emphasising the bass sounds.
Dual Sound	<p>"Stereo"/"Mono": For stereo broadcasts.</p> <p>"Main"/"Sub"/"Mono": For bilingual broadcasts, select "Main" for sound channel 1, "Sub" for sound channel 2, or "Mono" for mono channel, if available.</p> <ul style="list-style-type: none"> • If the signal is very weak, the sound becomes monaural automatically. • If the stereo sound is noisy when receiving a NICAM programme, select "Mono". The sound becomes monaural, but the noise is reduced. • The "Dual Sound" setting is memorized for each programme position. • You cannot listen to stereo broadcast sound when "Mono" is selected. <p> • If you select other equipment connected to the TV, set "Dual Sound" to "Stereo", "Main" or "Sub". However, when the external equipment connected to the HDMI jack (except HDMI 1) is selected, this is fixed to "Stereo".</p> <ul style="list-style-type: none"> • If you access to FM Radio mode, set "Dual Sound" to "Stereo" or "Mono".
Speakers	Selects sound output from TV speakers or external audio equipment. You can also turn on the connected equipment that is compatible with BRAVIA Sync Control, after making the appropriate settings of BRAVIA Sync Control.
Audio Out	<p>"Variable": When using an external audio system, volume output from audio out can be controlled using the TV's remote.</p> <p>"Fixed": The audio output of the TV is fixed. Use your audio receiver's volume control to adjust the volume (and other audio settings) through your audio system.</p>
HDMI/DVI Audio Source (only in HDMI 1 input mode)	Switches the audio signal for HDMI input when a DVI device is connected. Select from "Auto", "HDMI Audio" and "PC Audio".

Screen

Wide Mode	For details about wide mode, see page 9.
Auto Wide	Automatically changes the wide mode according to the input signal from an external equipment. To keep your setting, select "Off".  • Even if "Auto Wide" is set to "On" or "Off", you can always modify the format of the screen by pressing  repeatedly.
4:3 Default	Selects the default screen mode for use with 4:3 broadcasts.
Auto Display Area	Selects "On" to automatically adjusts the display area based upon the content or "Off" to choose from the "Display Area" options.
Display Area	Adjusts the picture display area. "Full Pixel" : Displays the picture for 1080/50i, 1080/60i, 1080/50p and 1080/60p sources (HDMI or component input only) or 1080/24p sources (HDMI input only) in the original size. "+1" : Displays pictures in their original size. This option may not be available depending on input signal. "Normal" : Displays pictures in their recommended size. "-1" : Enlarges the picture so that the edges are outside the visible display area.
Horizontal Shift	Adjusts the horizontal position of the picture when "Wide Mode" is set to "Wide Zoom" or "Zoom".
Vertical Shift	Adjusts the vertical position of the picture when "Wide Mode" is set to "Wide Zoom" or "Zoom".
PC Settings	Selects screen mode or adjusts the display position, phase and pitch of the picture when the TV receives an input signal from the connected PC.



PC input signal reference chart for PC and HDMI IN 1, 2

Signals	Horizontal (Pixel)	Vertical (Line)	Horizontal frequency (kHz)	Vertical frequency (Hz)	Standard
VGA	640	480	31.5	60	VGA
SVGA	800	600	37.9	60	VESA Guidelines
XGA	1024	768	48.4	60	VESA Guidelines
WXGA	1280	768	47.4	60	VESA
WXGA	1280	768	47.8	60	VESA
WXGA	1360	768	47.7	60	VESA
SXGA*	1280	1024	64	60	VESA
HDTV*	1920	1080	67.5	60	EIA

* For KLV-40EX430, KLV-40EX43A, KLV-40EX43B only.

-  • This TV's PC input does not support Sync on Green/Composite Sync and interlaced signal.
- This TV's PC input supports signals in the above chart with a 60 Hz vertical frequency.

Channel Set-up

1 Digit Direct	<p>When "1 Digit Direct" is set to "On", select a channel using one preset number button (0 - 9) on the remote.</p> <p> • When "1 Digit Direct" is set to "On", you cannot select channel numbers 10 and above entering next digit using the remote.</p>
Auto Tuning	Tunes in all the available channels.
Programme Sorting	Changes the order in which the channels are stored on the TV.
Programme Labels	Assigns a channel name of your choice up to seven letters or numbers.
Manual Programme Preset	<p>Before selecting "Label"/"AFT"/"Audio Filter"/"Skip"/"Colour System", press PROG +/- to select the programme number with the channel. You cannot select a programme number that is set to "Skip" (page 18).</p> <p>"Programme"/"TV System"/"Frequency": Presets programme channels manually.</p> <ol style="list-style-type: none">1 Select "Programme", then press ⊕.2 Press ⇅ to select the programme number you want to manually tune (if tuning a VCR, select channel 0), then press RETURN.3 Press ⇅ to select "TV System", then press ⊕.4 Press ⇅ to select your TV broadcast systems, then press ⊕.5 Press ⇅ to go to the frequency range indication ("VHF Low", "VHF High" or "UHF"), then press ⊕.6 Tune the channels as follows: Press ⇅ to search for the next available channel. When a channel has been found, the search will stop. To continue searching, press ⇅.<p>Repeat the procedure above to preset other channels manually.</p><p>"Label": Assigns a name of your choice, up to seven letters or numbers, to the selected channel.</p><p>"AFT": Fine-tune the selected channel manually. When "On" is selected, the fine tuning is performed automatically.</p><p>"Audio Filter": Improves the sound of individual channels when distortion occurs in mono broadcasts in TV system "B/G", "I" and "D/K".</p><p> • You cannot receive stereo or dual sound when "High" is selected.</p><p>"Skip": Skips unused channels when you press PROG +/- to select channels. (You can still select a skipped channel using the number buttons.)</p><p>"Colour System": Selects the colour system ("Auto", "PAL", "SECAM", "NTSC3.58", "NTSC4.43" or "PAL60") according to the channel.</p><p>"Signal Level": Displays the signal level for programme currently being watched.</p>
FM Radio Set-up	<p>Preset up to 30 FM radio stations that can be received in your area.</p> <p>"Auto Tuning": Automatically tune and store all the available channels.</p> <ol style="list-style-type: none">1 Select "Auto Tuning", then press ⊕.2 Select "OK" to automatically tune in all the available channels. <p>"FM Radio Presets": Manually tune and store each available channel one at a time.</p> <p> • To enable this feature, access to FM Radio mode by using Home Menu (page 12), then preset your desired FM radio stations according to the steps mentioned above.</p>

Parental Lock

PIN Code	Sets up TV to block channel or external input. Use 0-9 on the remote to enter a four-digit PIN code.
Change PIN Code	Selects to change your PIN code.
Programme Block	Blocks an individual channel from being watched. To view a blocked channel, select "Unblocked".
External Input Lock	Locks an external input from being watched. To view a blocked external input, select "Unblocked".

- Entering the correct PIN code for blocked channel or external input will temporarily deactivate the "Parental Lock" feature. To reactivate the "Parental Lock" settings, turn off and on the TV.
- If you lost your PIN code, see page 23.

Set-up

Photo Frame Settings	<p>"Display Mode": Allows you to select the display mode. Select from "Image and Clock", "Full Screen Image" and "Full Screen Clock".</p> <p>"Clock Display": Allows you to select the clock display. Select from "Calendar", "Analogue Clock", "Digital Clock", "Calendar and Clock" and "Clock". "Calendar", "Calendar and Clock" and "Clock" can be displayed only when "Display Mode" is "Full Screen Clock". "Calendar", "Analogue Clock" and "Digital Clock" can be displayed only when "Display Mode" is "Image and Clock".</p> <p>"Audio Application": Allows you to select "FM Radio" or "Music". Select "Off" to disable this function.</p> <p>"Image Selection": Selects image.</p> <p>"Music Selection": Selects music.</p> <p>"Slideshow Setting": Allows you to select "Slideshow" of multiple photos or "Single View" of a photo.</p> <p>"Music Playback Setting": Allows you to select "All Tracks" or "Single Track" for music playback.</p> <p>"Duration": Selects the time period after which the TV automatically switches to standby mode.</p> <p>"First day of the week": Sets "Sunday" or "Monday" as the first day of the week on the calendar.</p>
USB Auto Start	Automatically enters the thumbnail view of the last played Photo/Music/Video when the TV is turned on and a USB device is connected to the USB port then turned on.
Clock/Timers	<p>"Sleep Timer": Set the time in minutes that you would like the TV to remain on before shutting off automatically.</p> <p>"On Timer": Turns on the TV from standby mode at a time you set, and tuned to a channel or input of your preference.</p> <p>"Clock Set": Set the current time and date. This feature also can be set from initial set-up.</p>
Auto Start-up	Starts the initial set-up procedure (page 5).
Language	Selects the language in which the menus are displayed.
Start-up Logo	Select "On" to display logo when the TV is turned on. Select "Off" to disable it.

AV Set-up	<p>“Video Labels”: Assigns a name to any equipment connected to the side and rear jacks.</p> <ol style="list-style-type: none"> 1 Press to select the desired input source, then press . 2 Press to select the preset labels option, then press to assign a name to connected equipment. <p> • When the input source is set to “Skip” in the “Video Labels” under the “AV Set-up” menu, that input is greyed out in the list.</p> <p>“Colour System”: Selects the colour system (“Auto”, “PAL”, “SECAM”, “NTSC3.58”, “NTSC4.43” or “PAL60”) according to the composite video signal from the input source.</p> <p>“Video 2/Component Input”: Select “Auto” to have the TV detects and switch between the component video jack or the video jack 2 when component video jack or video jack 2 is connected.</p> <p> • You cannot use the component video jack and the video jack 2 at the same time.</p> <p>“Headphone/Audio Out”: Sets the sound output to headphones or external audio system connected to the TV. Disconnect headphones from the TV when you select “Audio Out”.</p>
BRAVIA Sync Settings	<p>Allows the TV to communicate with equipment that is compatible with the BRAVIA Sync Control function, and connected to the HDMI jacks of the TV. Note that communication settings must also be made on the connected equipment.</p> <p>“BRAVIA Sync Control”: Sets whether or not to link the operations of the TV and the connected equipment that is compatible with BRAVIA Sync Control. When set to “On”, the following functions are available. If the specific Sony equipment that is compatible with BRAVIA Sync Control is connected, this setting is applied to the connected equipment automatically when the “BRAVIA Sync Control” is set to “On” using the TV.</p> <p>“Auto Devices Off”: When this is set to “On”, the connected equipment that is compatible with BRAVIA Sync Control turns off when you turn off the TV by remote.</p> <p>“Auto TV On”: When this is set to “On”, the TV turns on when you turn on the connected equipment that is compatible with BRAVIA Sync Control.</p> <p>“Auto Input Change (MHL)”: When this is set to “On”, TV changes settings according to the output signal of MHL source device.</p> <p>“BRAVIA Sync Device List”: Displays a list of connected equipment that is compatible with BRAVIA Sync Control. Selects “Enable” to update the “BRAVIA Sync Device List”.</p> <p>“Device Control Keys”: Select button functions of the TV’s remote control to operate the connected equipment.</p> <p> • You cannot use “BRAVIA Sync Control” if the TV operations are linked to the operations of an audio system that is compatible with BRAVIA Sync Control.</p> <ul style="list-style-type: none"> • Some equipment with “BRAVIA Sync Control” does not support the “Device Control” feature.
Product Information	Displays your TV’s product information.
Factory Settings	Resets all settings to factory settings. After completing this process, the initial set-up screen is displayed.
 Eco	
Reset	Resets the current Eco settings to the default values.
Power Saving	Reduces power consumption of the TV by adjusting the backlight. When you select “Picture Off”, the picture is switched off, and the (Picture Off) indicator on the TV front panel lights up in green. The sound remains unchanged.
Idle TV Standby	Turns the TV off after it has been kept idle for the preset length of time.
PC Power Management	Switches the TV to standby mode when the TV receives no signal from the PC input source for 30 seconds.

Installing the accessories (Wall-Mount Bracket)

To Customers:

For product protection and safety reasons, Sony strongly recommends that installing of your TV be performed by Sony dealers or licensed contractors. Do not attempt to install it yourself.

To Sony Dealers and Contractors:

Provide full attention to safety during the installation, periodic maintenance and examination of this product.

Your TV can be installed using the Wall-Mount Bracket SU-WL50B (KLV-40EX430, KLV-40EX43A, KLV-40EX43B), SU-WL100 (KLV-32EX330, KLV-32EX33A, KLV-32EX33B) (sold separately).

- Refer to the Instructions supplied with the Wall-Mount Bracket to properly carry out the installation.
- Refer to "Detaching the Table-Top Stand from the TV" (page 5).

- Place the TV on the stand, when securing the Mounting Hook.

Sufficient expertise is required for installing these products, especially to determine the strength of the wall for withstanding the TV's weight. Be sure to entrust the attachment of these products to the wall to Sony dealers or licensed contractors and pay adequate attention to safety during the installation. Sony is not liable for any damage or injury caused by mishandling or improper installation.

Note when installing

When using the Wall-Mount Bracket, the space between the wall and the TV will be 6 cm. Use this space to route cables to the TV.

SU-WL50B: (KLV-40EX430, KLV-40EX43A, KLV-40EX43B)

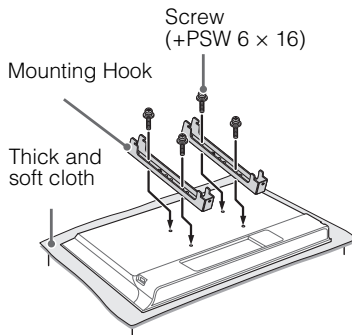

SU-WL100: (KLV-32EX330, KLV-32EX33A, KLV-32EX33B)

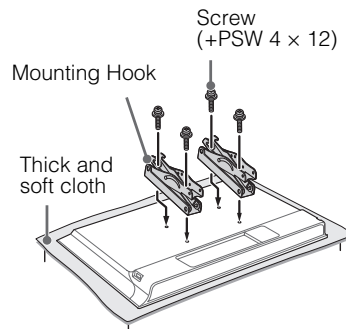

TV installation dimensions table

SU-WL50B

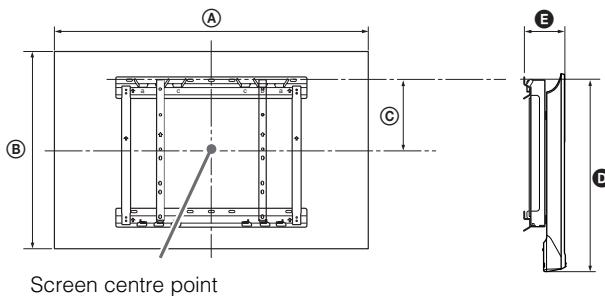

Unit: mm

	A	B	C	D	E
KLV-40EX430/ KLV-40EX43A/ KLV-40EX43B	930	568	249	548	114

Continued

SU-WL100

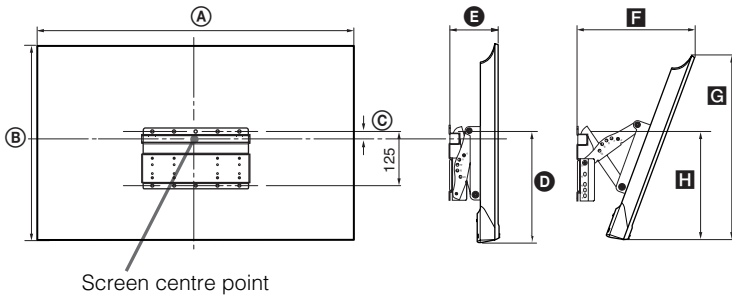

Unit: mm

				Angle (0°)		Angle (20°)		
	A	B	C	D	E	F	G	H
KLV-32EX330/ KLV-32EX33A/ KLV-32EX33B	737	459	16	259	112	249	425	249

Figures in the above table may differ slightly depending on the installation.

WARNING

The wall that the TV will be installed on should be capable of supporting a weight of at least four times that of the TV. Refer to “Specifications” for its weight.

Screw and hook locations diagram/table

SU-WL50B

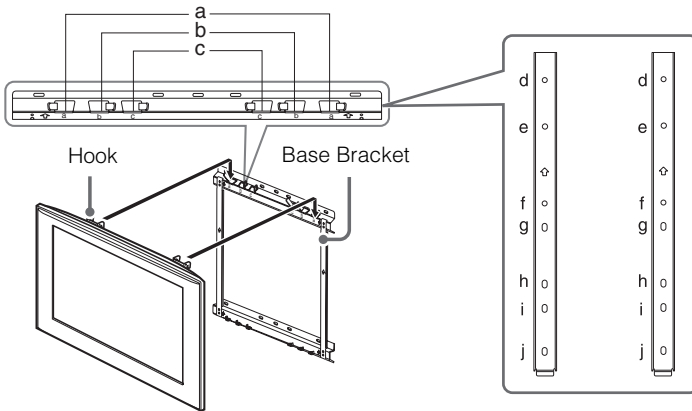

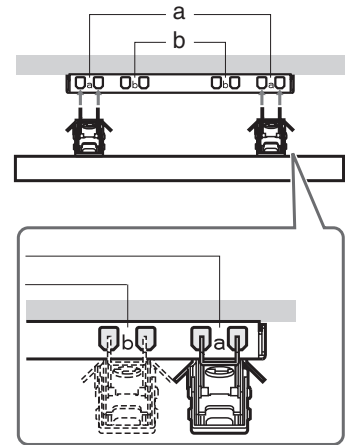

SU-WL100



	Screw location	Hook location	
	SU-WL50B	SU-WL50B	SU-WL100
KLV-40EX430/KLV-40EX43A/KLV-40EX43B	e, j	b	-
KLV-32EX330/KLV-32EX33A/KLV-32EX33B	-	-	a

Troubleshooting

When the  (standby) indicator is flashing, count how many times it flashes (interval time is three seconds).



Press  on the TV to turn it off, disconnect the AC power cord, and inform your dealer or Sony service centre of how the indicator flashes (number of flashes).

When it is not flashing

Check the items listed below. If the problem still persists, have your TV serviced by qualified service personnel.

Picture

No picture and no sound

- Check the antenna/cable connection.
- Connect the TV to the AC power outlet, and press  on the TV. If the  (standby) indicator lights up in red, press .

No picture from the connected equipment

- Turn the connected equipment on.
- Check the connection between the optional equipment and the TV.
- Press  repeatedly to select the desired input.
- Correctly insert the USB / MHL device.
- For USB device: Make sure that the USB device has been properly formatted.
- For MHL device: Ensure that the MHL device is connected to the HDMI1/MHL jack using an MHL cable.
- Operations are not guaranteed for all USB / MHL devices. Also, operations differ depending on the features of the USB / MHL device.

Double images or ghosting

- Check the antenna/cable connection, location or direction.

Only snow and noise appear on the screen

- Check if the antenna is broken or bent.
- Check if the antenna has reached the end of its serviceable life (three to five years in normal use, one to two years at the seaside).

Distorted picture (dotted lines or stripes)

- Keep the TV away from electrical noise sources such as cars, motorcycles, hair-dryers or optional equipment.
- When installing optional equipment, leave some space between the optional equipment and the TV.
- Check the antenna/cable connection.
- Keep the antenna/cable away from other connecting cables.

Picture or sound noise when viewing a TV channel

- Adjust "AFT" (Automatic Fine Tuning) to obtain better picture reception (page 18).

Tiny black points and/or bright points appear on the screen

- The screen is composed of pixels. This is not a malfunction.

Picture contours are distorted



- Change the current setting of "Cinema Drive" to other settings (page 15).

No colour on programmes

- Select "Reset" (page 15).

Sound

No sound, but good picture

- Press  +/- or  (Mute).
- Check if the "Speakers" is set to "TV Speakers" (page 16).

No sound or noisy sound

- Check if the TV system setting is appropriate (page 18).

Channels

Some channels are blank

- The channel is for scrambled/subscription service only. Subscribe to a pay TV service.
- Channel is used only for data (no picture or sound).
- Contact the broadcaster for transmission details.

General

The TV turns off automatically (the TV enters standby mode)

- Check if the "Sleep Timer" is activated (page 19).
- Check if the "Idle TV Standby" is activated (page 20).

Some input sources cannot be selected

- Select "Video Labels" and cancel "Skip" of the input source (page 20).

The remote does not function

- Replace the batteries.

HDMI equipment does not appear on "BRAVIA Sync Device List"

- Check that your equipment is compatible with BRAVIA Sync Control.

Cannot select "Off" in "BRAVIA Sync Control"

- If you have connected any audio system that is compatible with BRAVIA Sync Control, you cannot select "Off" in this menu. To change the audio output to the TV speaker, select "TV Speakers" in the "Speakers" menu (page 16).

The "Parental Lock" password has been forgotten

- Enter 9999 for the PIN code (PIN code 9999 is always accepted.) (page 19).

Specifications

System	
Panel system	LCD (Liquid Crystal Display) Panel
TV system	B/G, I, D/K, M
Colour/video system	PAL, PAL60, SECAM, NTSC4.43, NTSC3.58
Channel coverage	Analogue: UHF/VHF/Cable, depending on your country/area selection
Sound output	5 W + 5 W
Input/Output jacks	
Antenna (aerial)/cable	75 ohm external terminal for VHF/UHF
COMPONENT IN	YPbPr (Component Video): 1080p (50, 60Hz), 1080i (50, 60Hz), 720p (50, 60Hz), 576p, 576i, 480p, 480i Audio input (phono jacks)
VIDEO IN 2	Video input (common phono pin with Y input)
HDMI IN 1, 2	Video: 1080p (50, 60Hz), 1080/24p, 1080i (50, 60Hz), 720p (50, 60Hz), 576p, 576i, 480p, 480i, PC Formats Audio: Two channel linear PCM: 32, 44.1 and 48kHz, 16, 20 and 24 bits, Dolby Digital Analogue audio input (stereo minijack) (HDMI IN 1 Only, common with PC IN)
MHL (common with HDMI IN 1)	Video: 1080/24p, 1080i (50, 60Hz), 720p (50, 60Hz), 576p, 576i, 480p, 480i Audio: Two channel linear PCM: 32, 44.1 and 48kHz, 16, 20 and 24 bits, Dolby Digital
VIDEO IN 1	Video/Audio input (phono jacks)
AUDIO OUT/	Audio output (stereo minijack) Headphones jack
PC IN	Analogue RGB (Mini D-sub 15-pin)
PC/ HDMI1 AUDIO IN	Audio input (stereo minijack) (common for HDMI IN 1 and PC IN)
	USB port
19.5 V ---	AC adapter input

Model Name KLV-	40EX430	40EX43A	40EX43B	32EX330	32EX33A	32EX33B
Power and others						
Power requirements	110-240 V AC, 50/60 Hz					
Screen size (measured diagonally)	Approx. 101.6 cm/ 40 inches			Approx. 80.0 cm/ 32 inches		
Display resolution	1,920 dots (horizontal) × 1,080 lines (vertical)			1,366 dots (horizontal) × 768 lines (vertical)		
Power consumption	82 W (when using the AC adapter)			55 W (when using the AC adapter)		
Dimensions (Approx.) (w × h × d)						
with Table-Top Stand (mm)	930 × 586 × 208			737 × 477 × 167		
without Table-Top Stand (mm)	930 × 568 × 61			737 × 459 × 61		
Mass (Approx.)						
with Table-Top Stand (kg)	6.9			4.7		
without Table-Top Stand (kg)	6.6			4.5		
Optional accessories	Wall-Mount Bracket:SU-WL50B (KLV-40EX430, KLV-40EX43A, KLV-40EX43B) SU-WL100 (KLV-32EX330, KLV-32EX33A, KLV-32EX33B)					
Operating temperature	0 °C - 40 °C					
Operating humidity	10 % - 80 % RH (non-condensing)					

Design and specifications are subject to change without notice.



Customer support
<http://www.sony-asia.com/support>

<http://www.sony.net/>



* 4 4 3 1 7 0 2 1 3 * (1)