

General Description

Switching regulator and DC-DC Converter applications.
It s mainly suitable for Li-ion battery pack.

FEATURES

- $V_{DSS}=20V$, $I_D=7A$.
- Low Drain-Source On Resistance.
 - : $R_{DS(ON)}=20.5m\ \Omega$ (Max.) @ $V_{GS}=4.5V$
 - : $R_{DS(ON)}=21.0m\ \Omega$ (Max.) @ $V_{GS}=4.0V$
 - : $R_{DS(ON)}=22.5m\ \Omega$ (Max.) @ $V_{GS}=3.1V$
 - : $R_{DS(ON)}=26.0m\ \Omega$ (Max.) @ $V_{GS}=2.5V$
- ESD Protection.
- Super High Dense Cell Design.

MAXIMUM RATING (Ta=25°C)

CHARACTERISTIC		SYMBOL	RATING	UNIT
Drain-Source Voltage		V_{DSS}	20	V
Gate-Source Voltage		V_{GSS}	± 12	V
Drain Current	DC	I_D^*	7	A
	Pulsed	I_{DP}^*	28	
Source-Drain Diode Current		I_S^*	1.7	A
Drain Power Dissipation	Ta = 25°C	P_D^*	1.5	W
Maximum Junction Temperature		T_j	150	°C
Storage Temperature Range		T_{stg}	-55~150	°C
Thermal Resistance, Junction to Ambient		R_{thJA}^*	83.3	°C/W

Note) * : Surface Mounted on 1 × 1 FR4 Board, $t \leq 10sec$

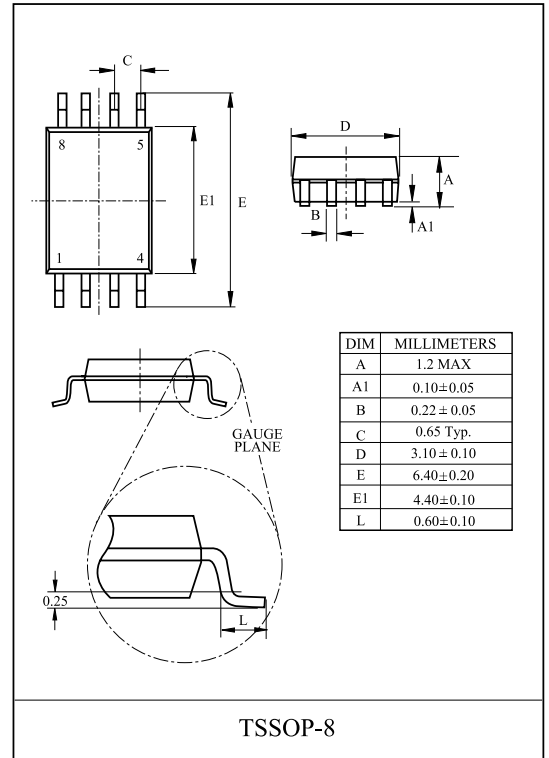

Marking

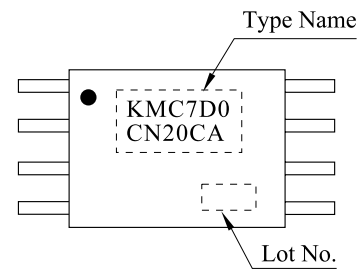

PIN CONNECTION (TOP VIEW)

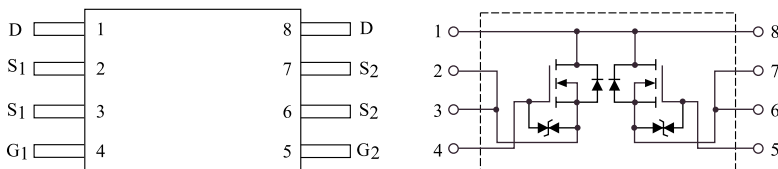

KMC7D0CN20CA

ELECTRICAL CHARACTERISTICS (Ta=25°C)

CHARACTERISTIC	SYMBOL	TEST CONDITION	MIN.	TYP.	MAX.	UNIT
Static						
Drain-Source Breakdown Voltage	BV_{DSS}	$V_{GS}=0V, I_D=250\mu A$	20	-	-	V
Drain Cut-off Current	I_{DSS}	$V_{DS}=16V, V_{GS}=0V$	-	-	1	μA
Gate Leakage Current	I_{GSS}	$V_{GS}=\pm 10V, V_{DS}=0V$	-	-	± 10	μA
Gate Threshold Voltage	V_{th}	$V_{DS}=V_{GS}, I_D=250\mu A$	0.5	0.7	1.5	V
Drain-Source ON Resistance	$R_{DS(ON)}^*$	$V_{GS}=4.5V, I_D=4.0A$	-	16.5	20.5	m Ω
		$V_{GS}=4.0V, I_D=4.0A$	-	17.0	21.0	
		$V_{GS}=3.1V, I_D=4.0A$	-	18.5	22.5	
		$V_{GS}=2.5V, I_D=4.0A$	-	20.5	26.0	
Forward Transconductance	g_{fs}^*	$V_{DS}=5V, I_D=5A$	-	12	-	S
Dynamic						
Input Capacitance	C_{iss}	$V_{DS}=10V, V_{GS}=0V, f=1.0MHz$	-	150	-	pF
Output Capacitance	C_{oss}		-	135	-	
Reverse transfer Capacitance	C_{rss}		-	120	-	
Total Gate Charge	Q_g^*	$V_{DS}=10V, I_D=7A$ $V_{GS}=4.0V$	-	7.5	-	nC
Gate-Source Charge	Q_{gs}^*		-	1.4	-	
Gate-Drain Charge	Q_{gd}^*		-	3.6	-	
Turn-on Delay time	$t_{d(on)}^*$	$V_{DS}=10V, I_D=4.0A, V_{GS}=4.0V,$ $R_G=6\Omega$	-	40	-	ns
Turn-on Rise time	t_r^*		-	160	-	
Turn-off Delay time	$t_{d(off)}^*$		-	190	-	
Turn-off Fall time	t_f^*		-	200	-	
Source-Drain Diode Ratings						
Source-Drain Diode Forward Voltage	V_{SD}^*	$V_{GS}=0V, I_S=1.7A$	-	0.8	1.2	V

Note > *Pulse test : Pulse width $\leq 300\mu s$, Duty Cycle $\leq 2\%$.

Fig 1. $I_D - V_{DS}$

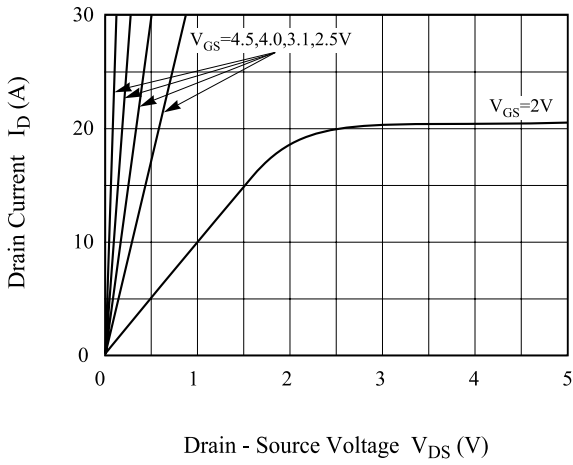

Fig 2. $R_{DS(ON)} - I_D$

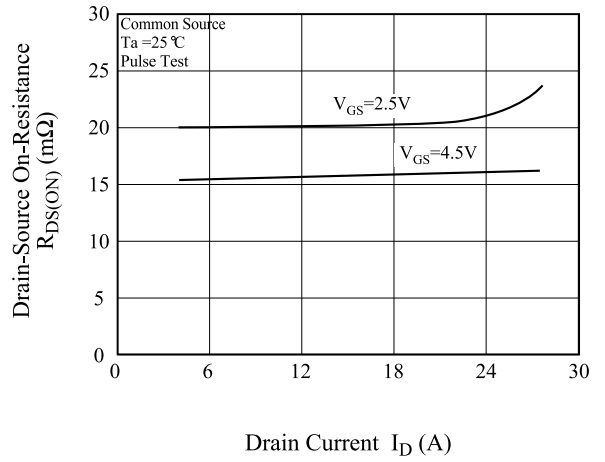

Fig 3. $I_D - V_{GS}$

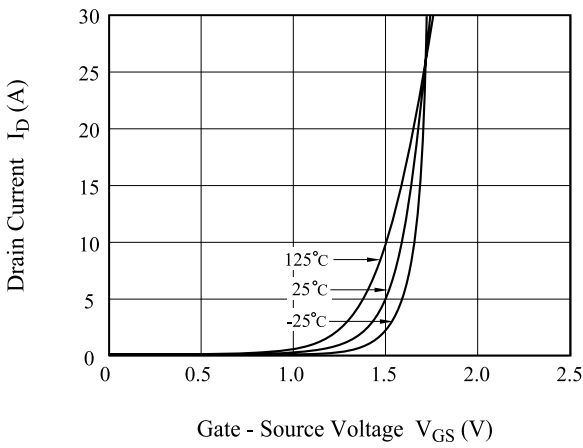

Fig 4. $R_{DS(ON)} - T_j$

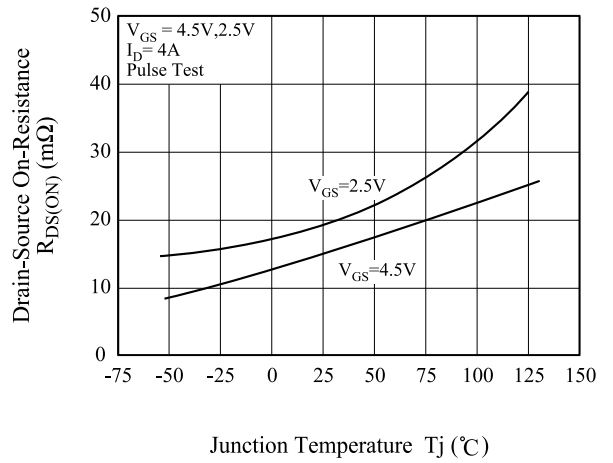

Fig 5. $V_{th} - T_j$

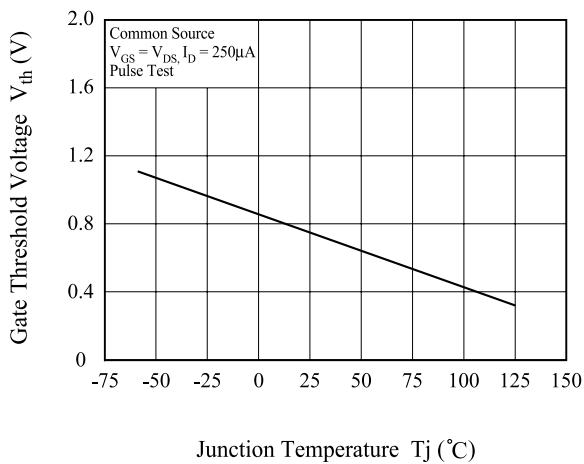
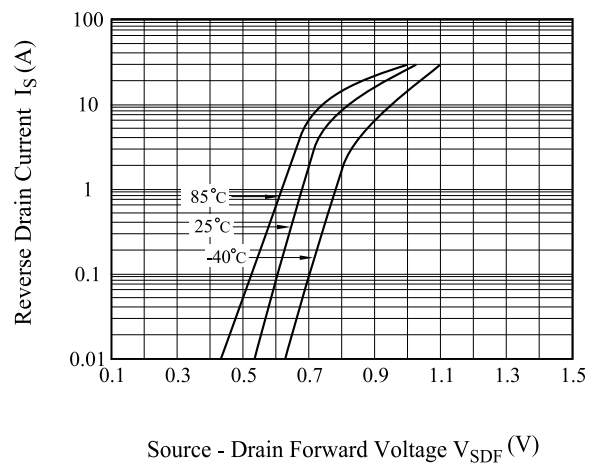

Fig 6. $I_S - V_{SD}$



KMC7D0CN20CA

Fig 7. C - V_{DS}

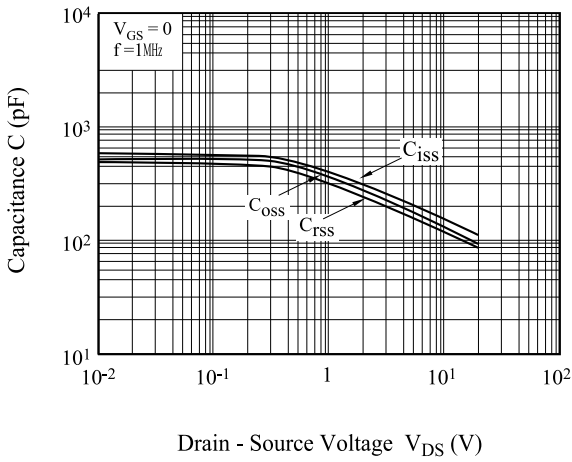

Fig 8. V_{GS} - Q_g

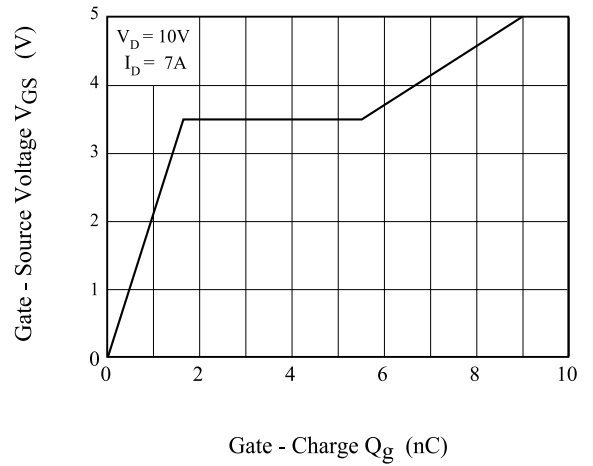

Fig 9. Safe Operating Area

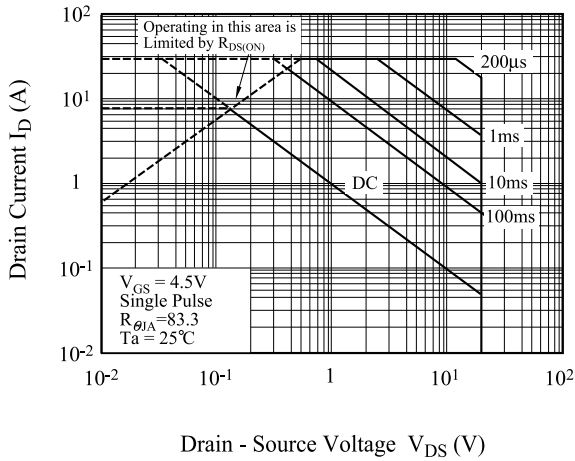

Fig 10. Transient Thermal Response Curve

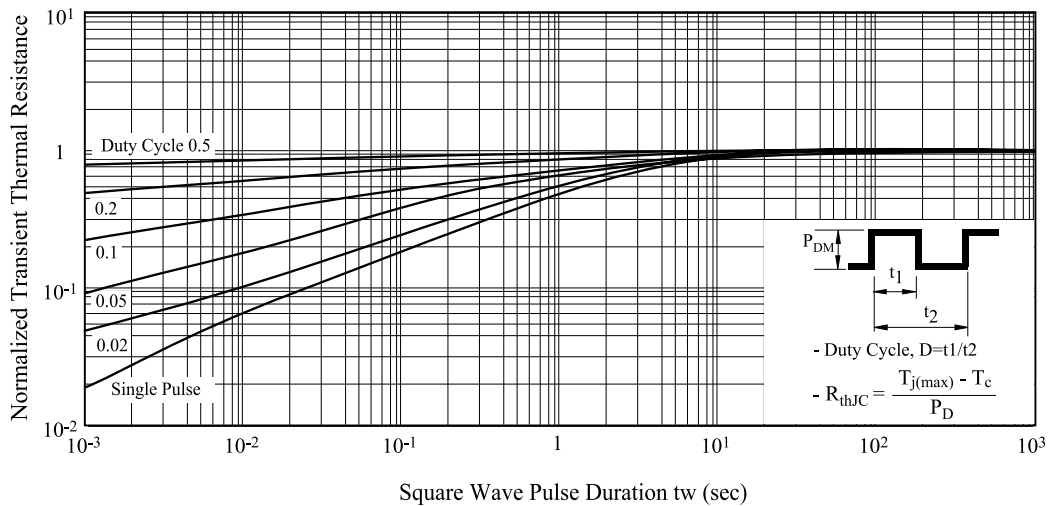

Fig. 1 Gate Charge

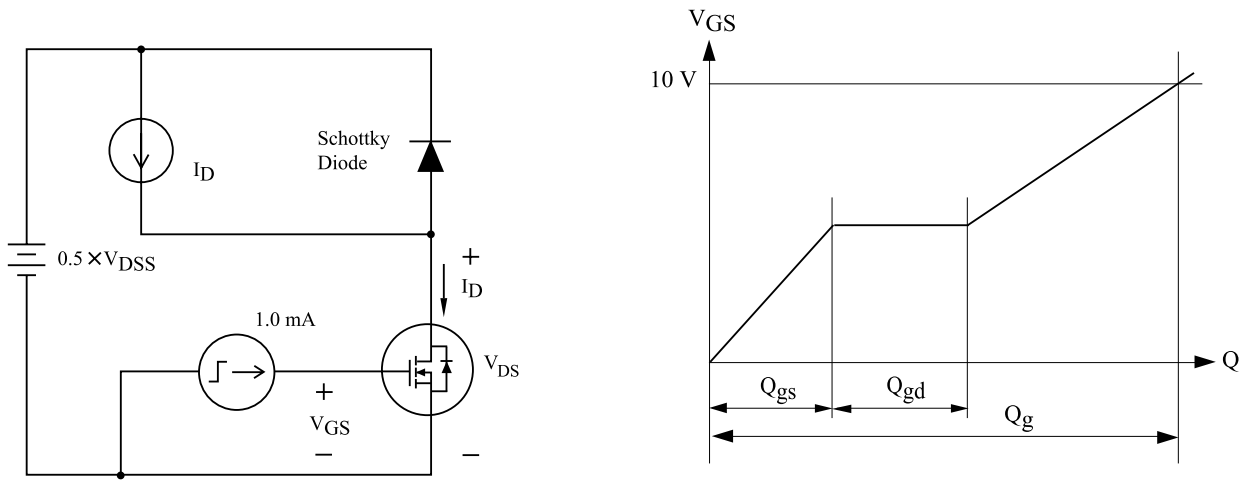

Fig. 2 Resistive Load Switching

