

**For 115/240 Vac (rms) Application:**

1. Solenoid/Valve Controls
2. Lighting Controls
3. Static Power Switches
4. Ac Motor Drives
5. Temperature Controls
6. E.M. Contactors
7. Ac Motor Starters
8. Solid State Relays
9. Available package : DIP/ SMD/ H.

**Outside Dimension : Unit (mm)**

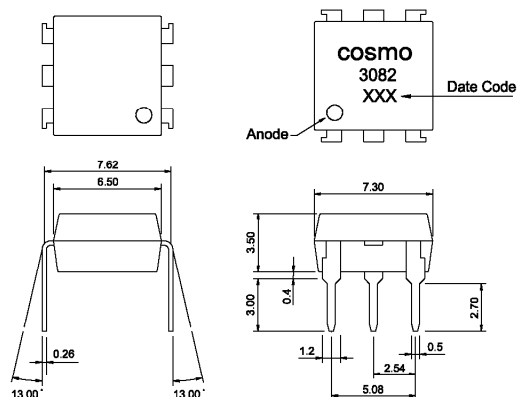

**Schematic : Top View**

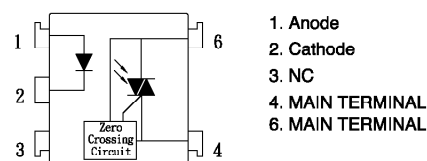

**Absolute Maximum Ratings**

(Ta=25°C)

Parameter	Symbol	Rating	Unit
Input	Forward current	IF	50 mA
	Peak forward current	IFM	1 A
	Reverse voltage	VR	6 V
	Power dissipation	PD	70 mW
Output	Off-State Output Terminal voltage	VDRM	800 Vpeak
	Peak Repetitive Surget Current	ITSM	1 A
	Power dissipation	PD	300 mW
Total power dissipation	Ptot	330 mW	
Isolation voltage 1 minute	Viso	5000 Vrms	
Operating temperature	Topr	-40 to +80 °C	
Storage temperature	Tstg	-40 to +125 °C	
Soldering temperature 10 seconds	Tsol	260 °C	

**Electro-optical Characteristics**

(Ta=25°C)

Parameter	Symbol	Conditions	MIN.	TYP.	MAX.	Unit
Input	Forward voltage	IF =10mA	—	1.2	1.4	V
	Reverse Leakage Current	VR =4V	—	—	10	UA
Output	Peak Blocking Current	VDRM =Rated	—	60	500	nA
	ON-State Voltage	ITM=100mA	—	1.8	3	V
	Critical rate of rise of OFF-state voltage	VDRM= (1/ √2) *Rated	600	—	—	V/uS
Transfer characteristics	Holding Current		—	100	—	uA
	Inhibit Voltage (MT1-MT2 Voltage above which device not trigger.)	IF =10mA	—	8	20	V
	Leakage in Inhibited State	IF =Rated IFT, Rated VDRM, Off State	—	—	500	uA
	Isolation resistance	DC500V	5x10 <sup>10</sup>	10 <sup>11</sup>	—	ohm
Minimum trigger current	IFT	Main Terminal Voltage=3V	—	—	10	mA

