

# PRODUCT SPECIFICATION

DATE : 01/20/2010

<b>cosmo</b> ELECTRONICS CORPORATION	Photocoupler : <b>KP4010S</b>	NO.61P20007	REV.
		SHEET 1 OF 6	1

## High Reliability Photocoupler

### ● Features

1. High current transfer ratio ( $V_{ce0} : 300V \text{ min}$ )  
( CTR : Min. 600% at  $I_F=1mA$   $V_{CE}=2V$  )
2. High isolation voltage between input and output  
( Viso : 5000Vrms )
3. Compact surface mount type package.

### ● Application :

1. System appliances, measuring instruments.
2. Industrial robots.
3. Copiers, automatic vending machines.
4. Signal transmission between circuits of different potentials and impedances.
5. Telephone sets.
6. Copiers, facsimiles.
7. Interface with various power supply circuits, power distribution boards.
8. Numerical control machines.

# PRODUCT SPECIFICATION

DATE : 01/20/2010

<b>cosmo</b> ELECTRONICS CORPORATION	Photocoupler : <h2>KP4010S</h2>	NO.61P20007	REV. 1
		SHEET 2 OF 6	

## ● Outside Dimension : Unit ( mm )

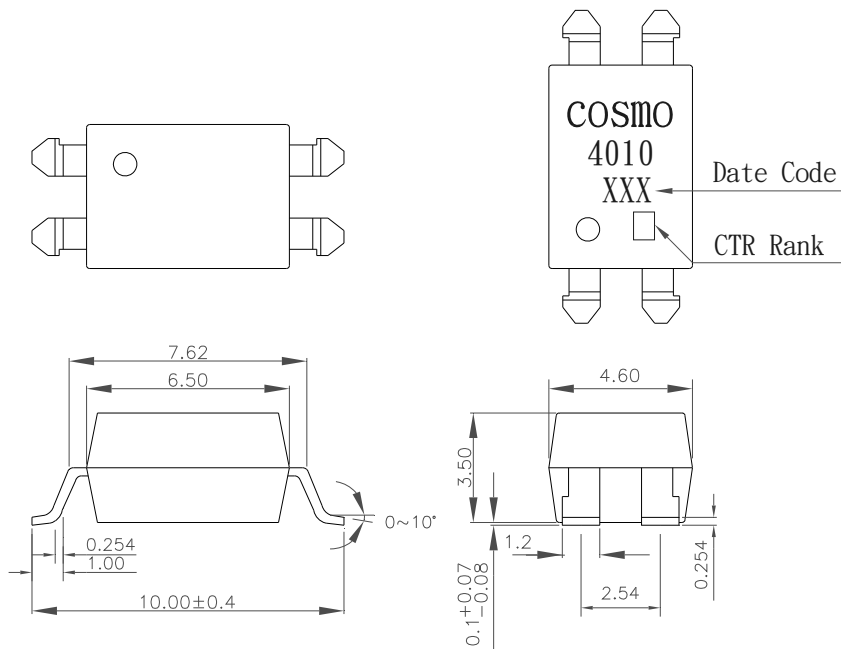

**TOLERANCE : ±0.2mm**

## ● Schematic : Top View

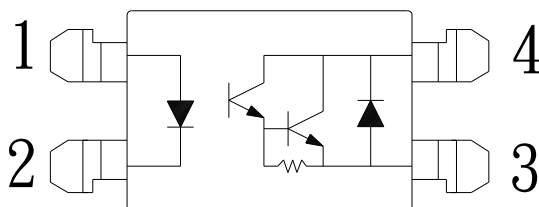

1. Anode
2. Cathode
3. Emitter
4. Collector

# PRODUCT SPECIFICATION

DATE : 01/20/2010

<b>cosmo</b> ELECTRONICS CORPORATION	Photocoupler : <b>KP4010S</b>	NO.61P20007	REV.
		SHEET 3 OF 6	1

## ● Absolute Maximum Ratings

Parameter		Symbol	Rating	Unit
Input	Forward current	$I_F$	50	mA
	Peak forward current	$I_{FM}$	1	A
	Reverse voltage	$V_R$	6	V
	Power dissipation	$P_D$	70	mW
Output	Collector-emitter voltage	$V_{CEO}$	300	V
	Emitter-collector voltage	$V_{ECO}$	0.1	V
	Collector current	$I_C$	150	mA
	Collector power dissipation	$P_C$	200	mW
Total power dissipation		$P_{tot}$	200	mW
Isolation voltage 1 minute		$V_{iso}$	5000	Vrms
Operating temperature		$T_{opr}$	-55 to +100	°C
Storage temperature		$T_{stg}$	-55 to +125	°C
Soldering temperature 10 second		$T_{sol}$	260	°C

## ● Electro-optical Characteristics

Parameter		Symbol	Conditions	MIN.	TYP.	MAX.	Unit
Input	Forward voltage	$V_F$	$I_F=20mA$	-	1.2	1.4	V
	Peak forward voltage	$V_{FM}$	$I_{FM}=0.5A$	-	-	3.5	V
	Reverse current	$I_R$	$V_R=4V$	-	-	10	$\mu A$
	Terminal capacitance	$C_t$	$V=0, f=1KHz$	-	30	-	pF
Output	Collector dark current	$I_{CEO}$	$V_{CE}=200V$	-	-	1.0	$\mu A$
Transfer characteristics	Current transfer ratio	CTR	$I_F=1mA, V_{CE}=2V$	600	-	9000	%
	Collector-emitter saturation	$V_{CE(sat)}$	$I_F=20mA, I_C=5mA$	-	-	1.5	V
	Isolation resistance	$R_{iso}$	DC500V	$5 \times 10^{10}$	-	-	$\Omega$
	Floating capacitance	$C_f$	$V=0, f=1MHz$	-	0.6	1.0	pF
	Cut-off frequency	$f_C$	$V_{CC}=5V, I_C=2mA, R_L=100\Omega$	-	7	-	KHz
	Response time ( Rise )	$t_r$	$V_{CE}=2V, I_C=20mA, R_L=100\Omega$	-	60	300	$\mu s$
	Response time ( Fall )	$t_f$		-	50	250	$\mu s$

# PRODUCT SPECIFICATION

DATE : 01/20/2010

**cosmo**  
ELECTRONICS CORPORATION

Photocoupler :  
**KP4010S**

NO.61P20007  
SHEET 4 OF 6

REV.  
1

Classification table of current transfer ratio is shown below.

Model No.	CTR (%)
KP40102A	600 ~ 2000
KP40102B	1500 ~ 4000
KP40102C	3000 ~ 6000
KP40102D	5000 ~ 9000
KP40102E	600 ~ 9000

Fig.1

Current Transfer Ratio vs. Forward Current

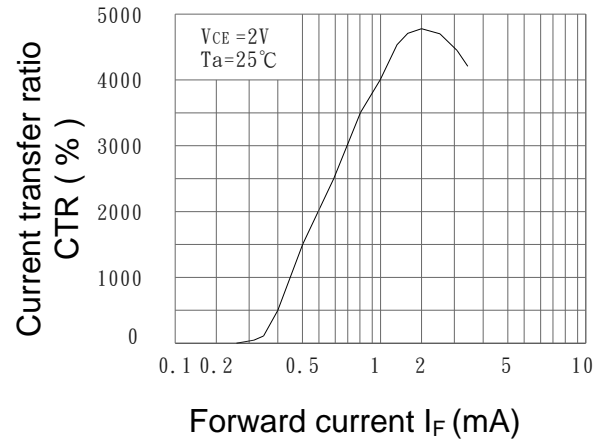

Fig.2

Collector Power Dissipation vs. Ambient Temperature

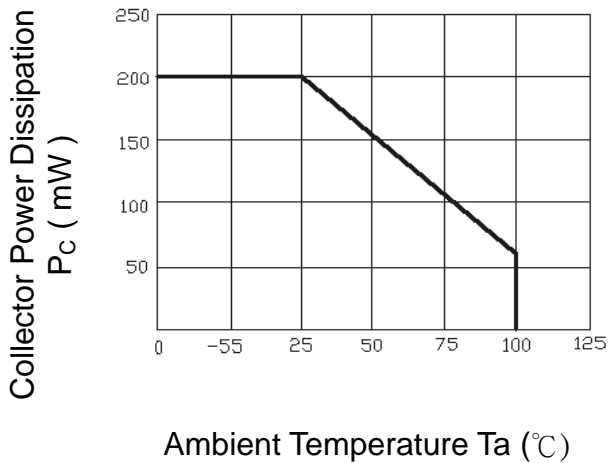

Fig.3

Collector Dark Current vs. Ambient Temperature

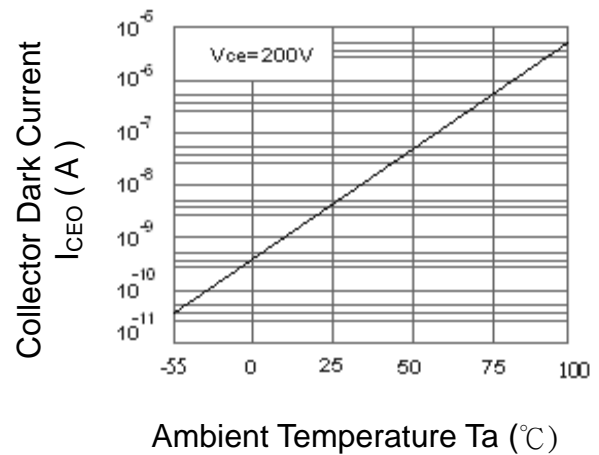

Fig.4

Forward Current vs. Ambient Temperature

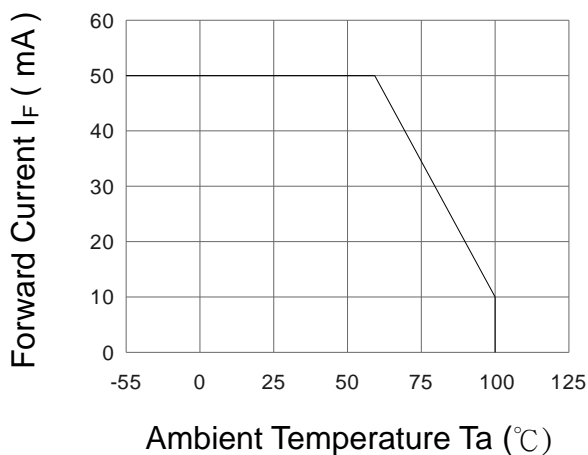
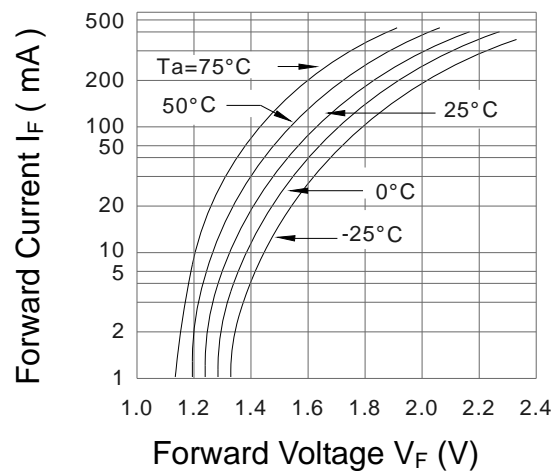

Fig.5

Forward Current vs. Forward Voltage



# PRODUCT SPECIFICATION

DATE : 01/20/2010

**cosmo**  
ELECTRONICS CORPORATION

Photocoupler :  
**KP4010S**

NO.61P20007  
SHEET 5 OF 6

REV.  
1

Fig.6 Collector Current vs. Collector-Emitter Voltage

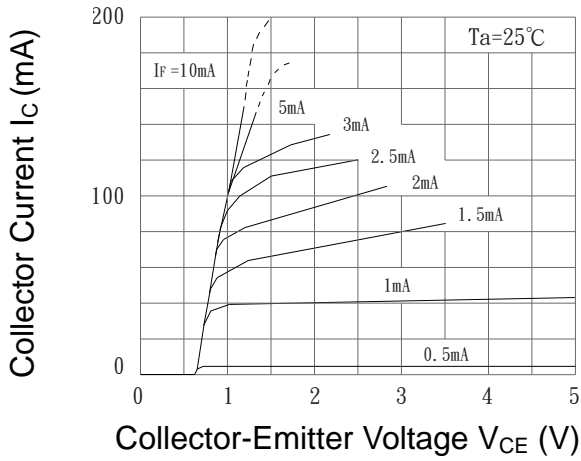

Fig.7 Relative Current Transfer Ratio vs. Ambient Temperature

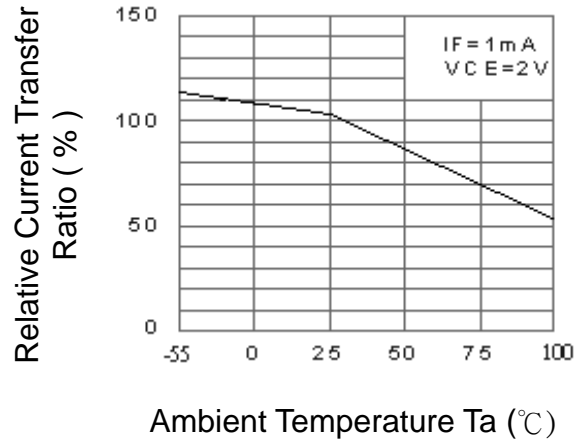

Fig.8 Collector-Emitter Saturation Voltage vs. Forward Current

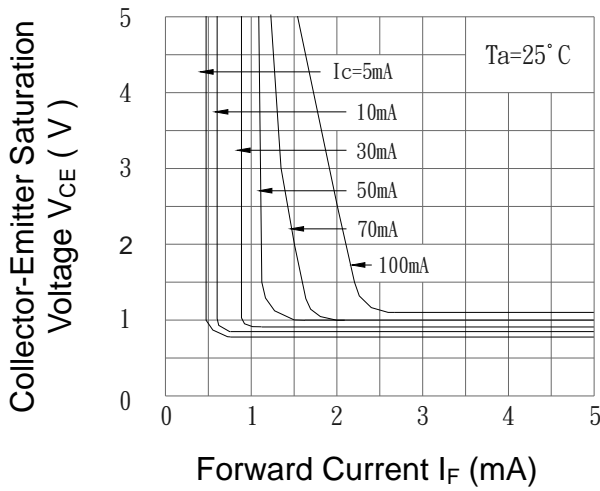
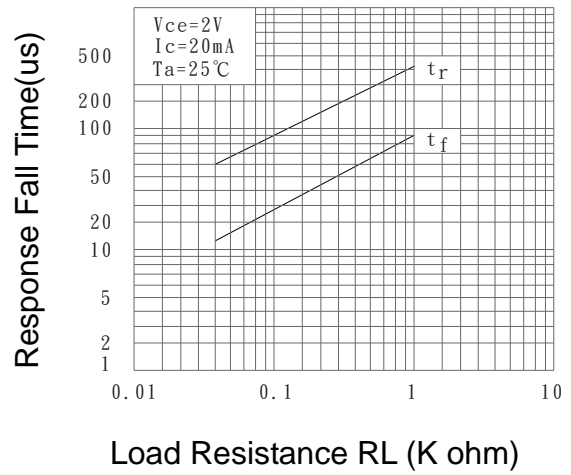

Fig.9 Response time vs. Load Resistance



# PRODUCT SPECIFICATION

DATE : 01/20/2010

<b>cosmo</b> ELECTRONICS CORPORATION	Photocoupler : <b>KP4010S</b>	NO.61P20007	REV.
		SHEET 6 OF 6	1

## ● Notice

The information contained in this document is intended to be a general product description and is subject to change without notice. Please contact cosmo in order to obtain the latest device data sheets before using any cosmo device. cosmo does not assume any responsibility for use of any circuitry described. No circuit patent licenses are implied. This publication is the property of cosmo. No part of this publication may be reproduced or copied in any form or by any means, or transferred to any third party without the prior written consent of cosmo Electronics Corporation.

The devices listed in this document are designed for general applications only in electronic equipment. No devices shall be deployed which require higher level of reliability such as :

- Medical and other life support equipments.
- Space application.
- Telecommunication equipment ( trunk lines ).
- Nuclear power control equipment.

Unless it received prior written approval from cosmo.

cosmo takes no responsibility for damages arise form the improper usage of our device. Please contact cosmo for further information regarding the above notices.