

**Features**

1. High sensitivity.
2. TTL and LSTTL compatible output.
3. Operating supply voltage range.  
(Vcc 4.5V to 17V)
4. Output form pull-up resistor built-in type.
5. Low output current dissipation.  
(Iccl:MAX. 3.8mA)
6. High isolation voltage between input and output  
(Viso:5000Vrms).
7. Available package : DIP/ SMD/ H. (For Package Dimension please refer to page 82 )

**Applications**

1. Computer terminals.
2. High speed line receivers.
3. Interfaces with various data transmission equipment.
4. Switching regulators.

**Outside Dimension : Unit (mm)**

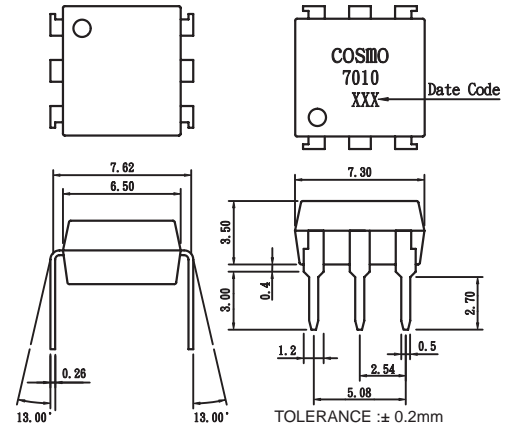

**Schematic : Top View**

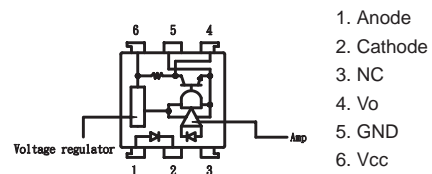

**Absolute Maximum Ratings**

(Ta=25°C)

Parameter	Symbol	Rating	Unit
Input	Forward current	IF	10 mA
	Peak forward current	IFM	1 A
	Reverse voltage	VR	6 V
	Power dissipation	PD	70 mW
Output	Supply voltage	VCC	-0.5 to 17 V
	Output current	IO	50 mA
	Power dissipation	PD	150 mW
Total power dissipation	Ptot	170 mW	
Isolation voltage 1 minute	Viso	5000	Vrms
Operating temperature	Topr	-25 to +85	°C
Storage temperature	Tstg	-40 to +125	°C
Soldering temperature	Tsol	260	°C

**Electro-optical Characteristics**

(Ta=25°C)

Parameter	Symbol	Conditions	MIN.	TYP.	MAX.	Unit	
Input	Forward voltage	IF = 10mA	—	1.2	1.4	V	
	Peak forward voltage	IFM = 0.5A	—	—	3.5	V	
	Reverse current	VR = 4V	—	—	10	uA	
	Terminal capacitance	V=0, f=1kHz	—	30	—	pF	
Output	Operating supply voltage		4.5	—	17	V	
	Low level output voltage	IoL = 16mA, Vcc = 5V, IF = 0	—	0.15	0.4	V	
	High level output voltage	Vcc = 5V, IF = 4mA	3.5	—	—	V	
	Low level supply current	Vcc = 5V, IF = 0	—	1.7	3.8	mA	
	High level supply current	Vcc = 5V, IF = 1mA	—	0.7	2.2	mA	
Transfer characteristics	"High-Low" Threshold input current	Vcc = 5V, RL = 280ohm	0.1	0.4	—	mA	
	" Low -High " Threshold input current	Vcc = 5V, RL = 280ohm	—	0.5	1.0	mA	
	Hysteresis	Vcc = 5V, RL = 280ohm	—	0.8	—	—	
	Isolation resistance	Ta = 25°C, DC500V	5x10 <sup>10</sup>	10 <sup>11</sup>	—	ohm	
	Response time	"High-Low" propagation delay time	Ta = 25°C, Vcc = 5V, IF = 1mA, RL = 280ohm	—	5	15	us
		" Low -High " propagation delay time		—	3	9	
		Fall time		—	0.05	0.5	
		Rise time		—	0.1	0.5	

**Fig.1** Low Level Output Current vs. Ambient Temperature

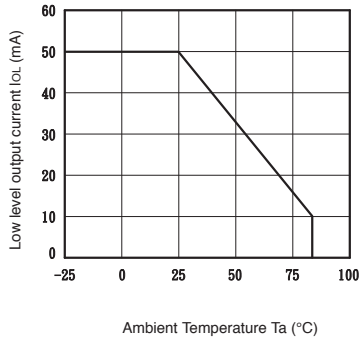

**Fig.2** Power Dissipation vs. Ambient Temperature

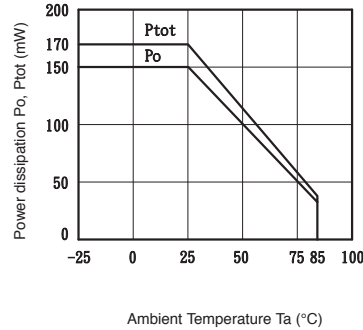

**Fig.3** Rise Time, Fall Time vs. Load Resistance

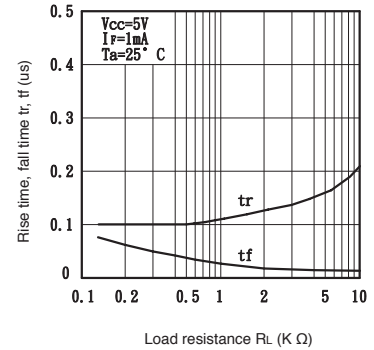

**Fig.4** Forward Current vs. Forward Voltage

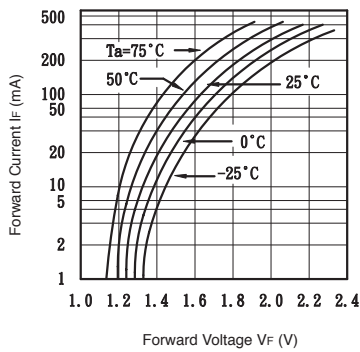

**Fig.5** Supply Current vs. Ambient Temperature

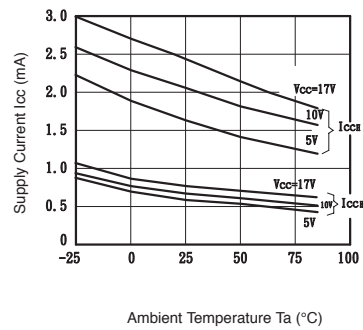

**Fig.6** Low Level Output Voltage vs. Ambient Temperature

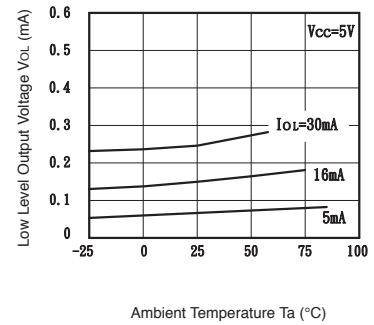

**Fig.7** Propagation Delay Time vs. Forward Current

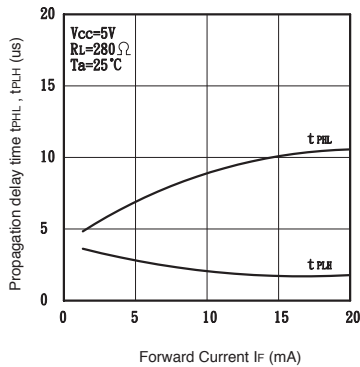

**Fig.8** Low Level Output Voltage vs. Low Level Output Current

