

General Description

This Super Junction MOSFET has better characteristics, such as fast switching time, low on resistance, low gate charge and excellent avalanche characteristics. It is mainly suitable for active power factor correction and switching mode power supplies.

FEATURES

- $V_{DSS}=600V$, $I_D=8A$
- Drain-Source ON Resistance :
 $R_{DS(ON)}(Max)=0.58$ @ $V_{GS}=10V$
- $Qg(\text{typ.})= 16nC$

MAXIMUM RATING (Tc=25 °C)

CHARACTERISTIC	SYMBOL	RATING	UNIT
Drain-Source Voltage	V_{DSS}	600	V
Gate-Source Voltage	V_{GSS}	± 30	V
Drain Current	@Tc=25	8	A
	@Tc=100	5	
	Pulsed (Note1)	18*	
Single Pulsed Avalanche Energy (Note 2)	E_{AS}	125	mJ
Repetitive Avalanche Energy (Note 1)	E_{AR}	3.7	mJ
Peak Diode Recovery dv/dt (Note 3)	dv/dt	4.5	V/ns
Drain Power Dissipation	Tc=25	73.5	W
	Derate above 25	0.59	W/°C
Maximum Junction Temperature	T_j	150	
Storage Temperature Range	T_{stg}	-55 ~ 150	
Thermal Characteristics			
Thermal Resistance, Junction-to-Case	R_{thJC}	1.7	/W
Thermal Resistance, Junction-to-Ambient	R_{thJA}	110	/W

* : Drain current limited by maximum junction temperature.

PIN CONNECTION

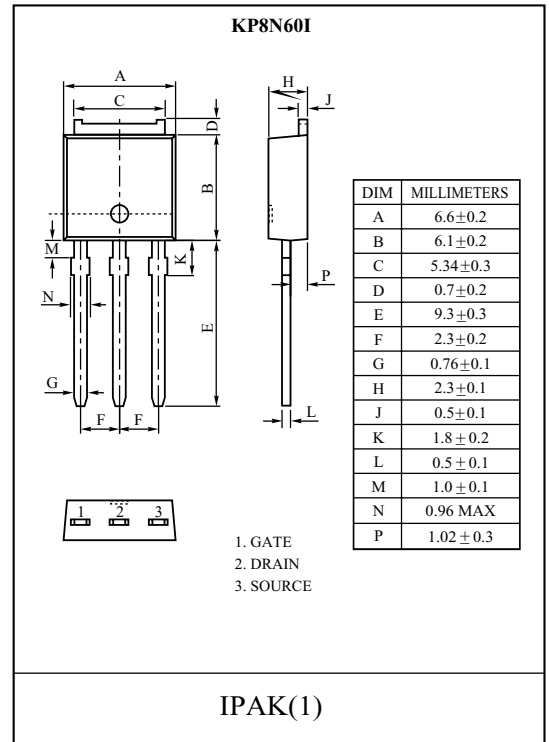
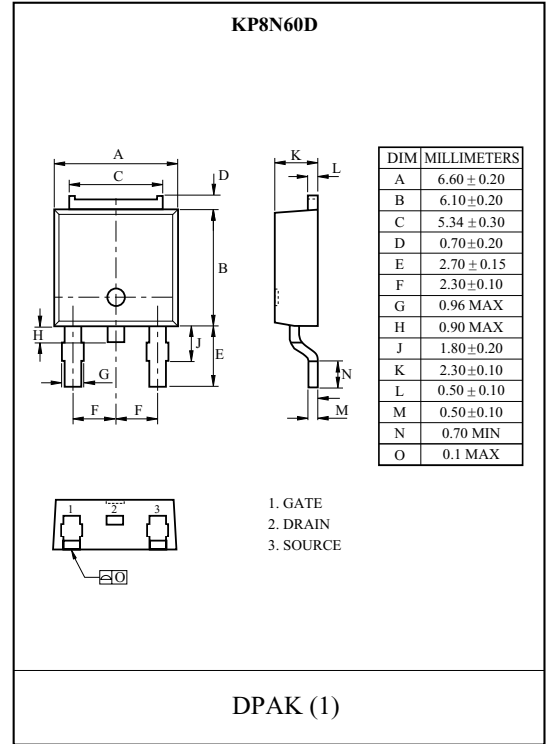
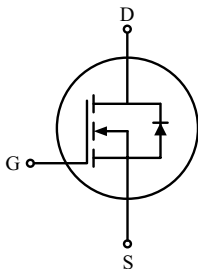

KP8N60D/I

ELECTRICAL CHARACTERISTICS (Tc=25)

CHARACTERISTIC	SYMBOL	TEST CONDITION	MIN.	TYP.	MAX.	UNIT
Static						
Drain-Source Breakdown Voltage	BV_{DSS}	$I_D=250\ \mu A, V_{GS}=0V$	600	-	-	V
Breakdown Voltage Temperature Coefficient	BV_{DSS}/T_j	$I_D=250\ \mu A$, Referenced to 25	-	0.6	-	V/
Drain Cut-off Current	I_{DSS}	$V_{DS}=600V, V_{GS}=0V$	-	-	10	μA
Gate Threshold Voltage	V_{th}	$V_{DS}=V_{GS}, I_D=250\ \mu A$	2.0	-	4.0	V
Gate Leakage Current	I_{GSS}	$V_{GS}=\pm 30V, V_{DS}=0V$	-	-	± 100	nA
Drain-Source ON Resistance	$R_{DS(ON)}$	$V_{GS}=10V, I_D=4A$	-	0.52	0.58	
Dynamic						
Total Gate Charge	Q_g	$V_{DS}=480V, I_D=8A$ $V_{GS}=10V$ (Note 5)	-	16	-	nC
Gate-Source Charge	Q_{gs}		-	3.1	-	
Gate-Drain Charge	Q_{gd}		-	6.5	-	
Turn-on Delay time	$t_{d(on)}$	$V_{DD}=300V$ $I_D=8A$ $R_G=25$ (Note4,5)	-	19	-	ns
Turn-on Rise time	t_r		-	20	-	
Turn-off Delay time	$t_{d(off)}$		-	49	-	
Turn-off Fall time	t_f		-	15	-	
Input Capacitance	C_{iss}	$V_{DS}=25V, V_{GS}=0V, f=1.0MHz$	-	600	-	pF
Output Capacitance	C_{oss}		-	550	-	
Reverse Transfer Capacitance	C_{rss}		-	2.7	-	
Source-Drain Diode Ratings						
Continuous Source Current	I_S	$V_{GS}<V_{th}$	-	-	8	A
Pulsed Source Current	I_{SP}		-	-	32	
Diode Forward Voltage	V_{SD}	$I_S=8A, V_{GS}=0V$	-	-	1.4	V
Reverse Recovery Time	t_{rr}	$I_S=8A, V_{GS}=0V,$ $dI_S/dt=100A/\mu s$	-	280	-	ns
Reverse Recovery Charge	Q_{rr}		-	2.4	-	μC

Note 1) Repetivity rating : Pulse width limited by junction temperature.

Note 2) $L=3.65mH, I_S=8A, V_{DD}=50V, R_G=25$, Starting $T_j=25$.

Note 3) $I_S=8A, dI/dt=100A/\mu s, V_{DD}=BV_{DSS}$, Starting $T_j=25$.

Note 4) Pulse Test : Pulse width $10\mu s$, Duty Cycle 2%.

Note 5) Essentially independent of operating temperature.

Marking

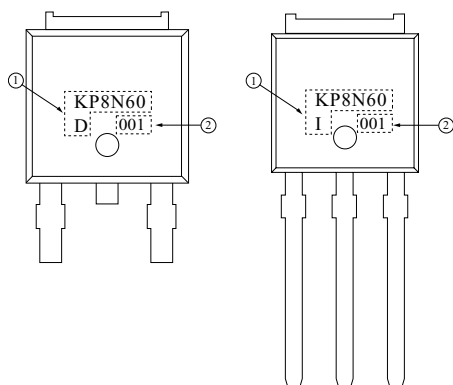

① PRODUCT NAME

② LOT NO

KP8N60D/I

Fig1. $I_D - V_{DS}$

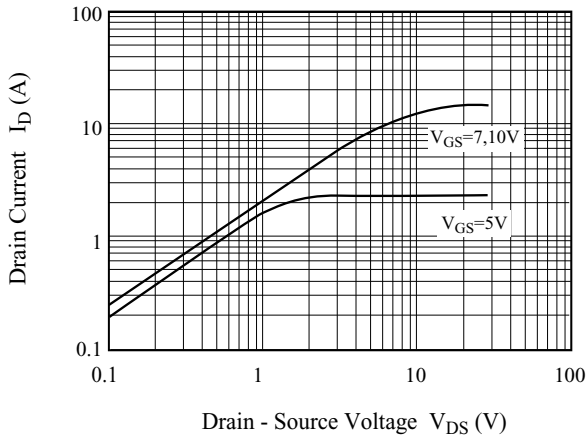

Fig2. $I_D - V_{GS}$

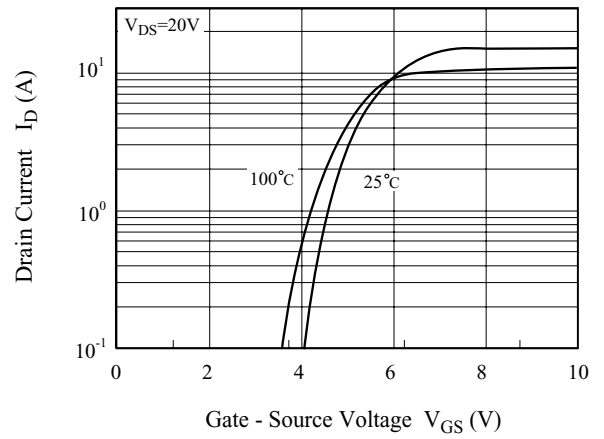

Fig3. $BV_{DSS} - T_j$

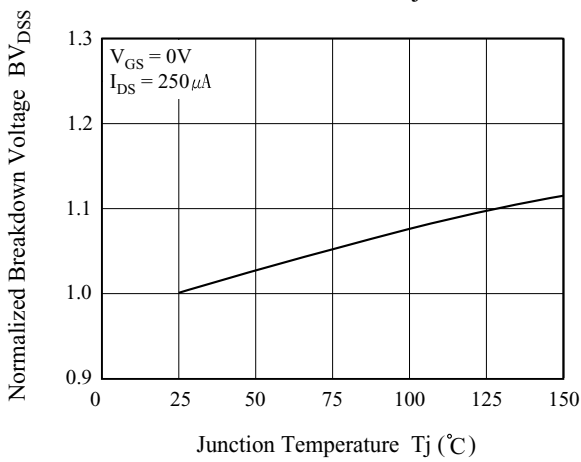

Fig4. $R_{DS(ON)} - I_D$

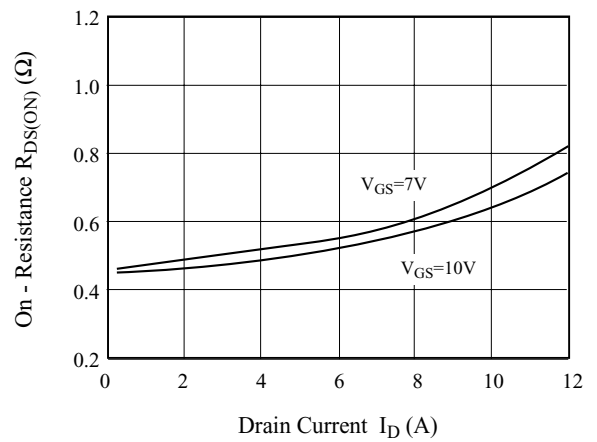

Fig5. $I_S - V_{SD}$

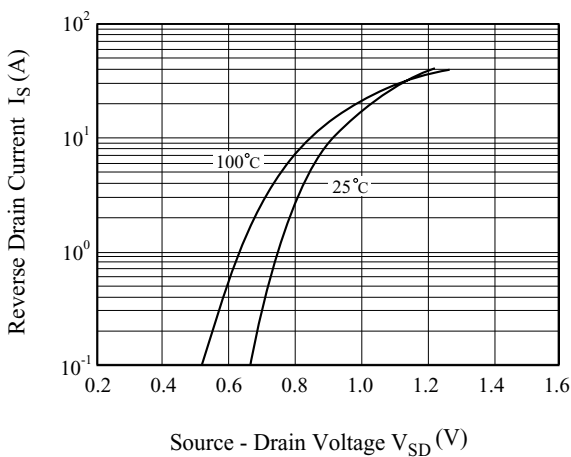
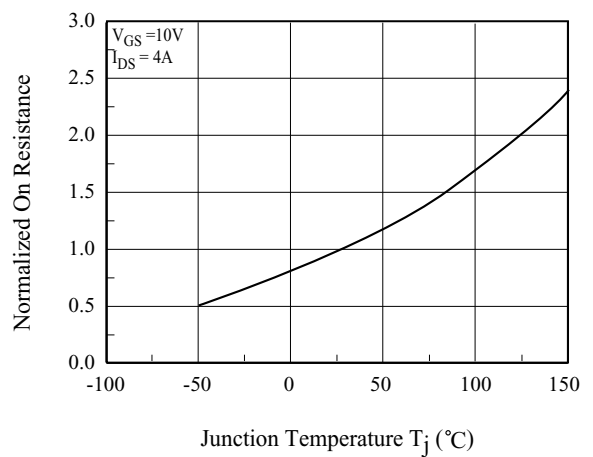

Fig6. $R_{DS(ON)} - T_j$



KP8N60D/I

Fig 7. C - V_{DS}

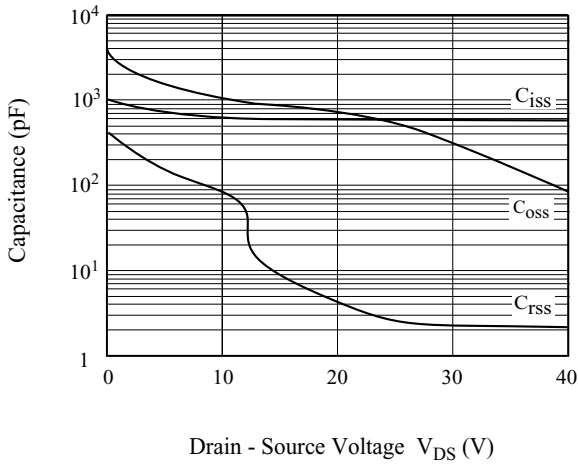

Fig8. Q_g- V_{GS}

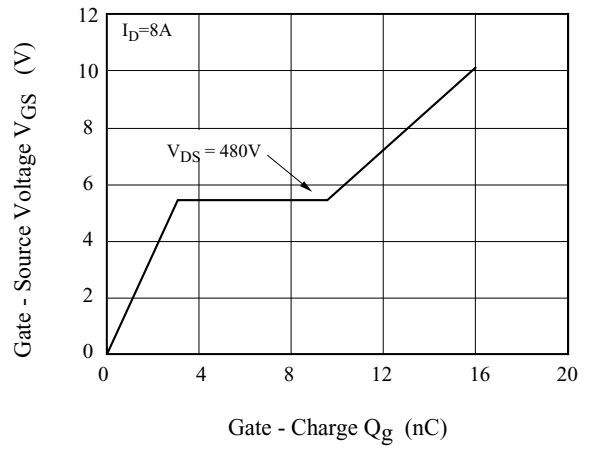

Fig9. Safe Operation Area

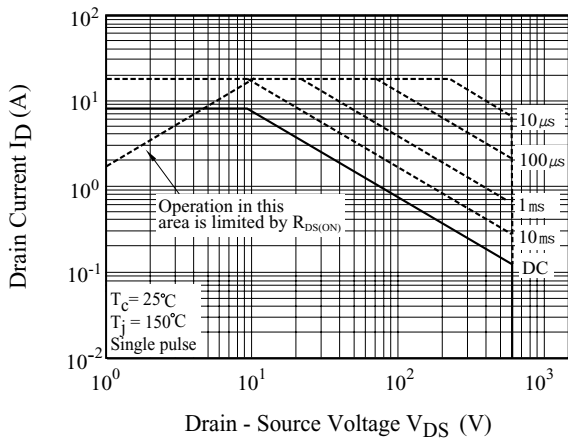

Fig10. I_D - T_J

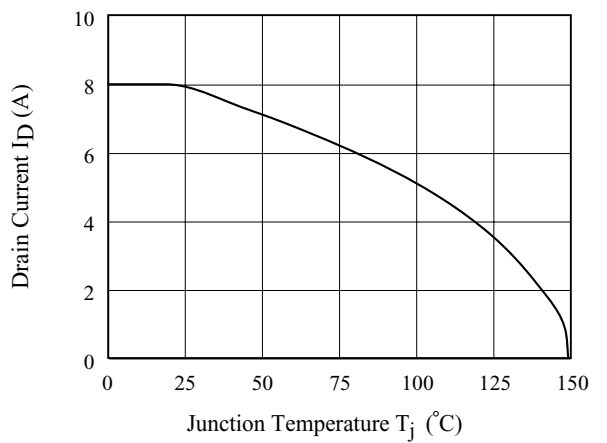
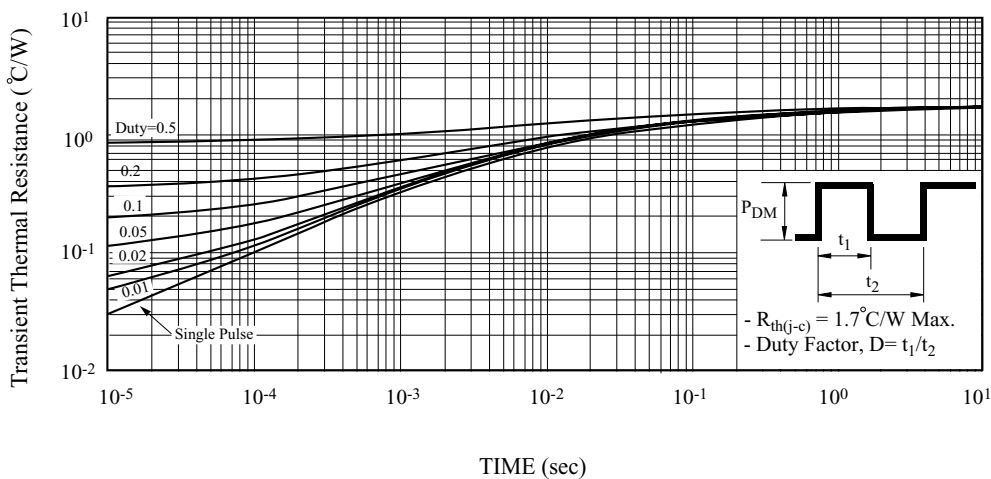

Fig11. Transient Thermal Response Curve



KP8N60D/I

Fig12. Gate Charge

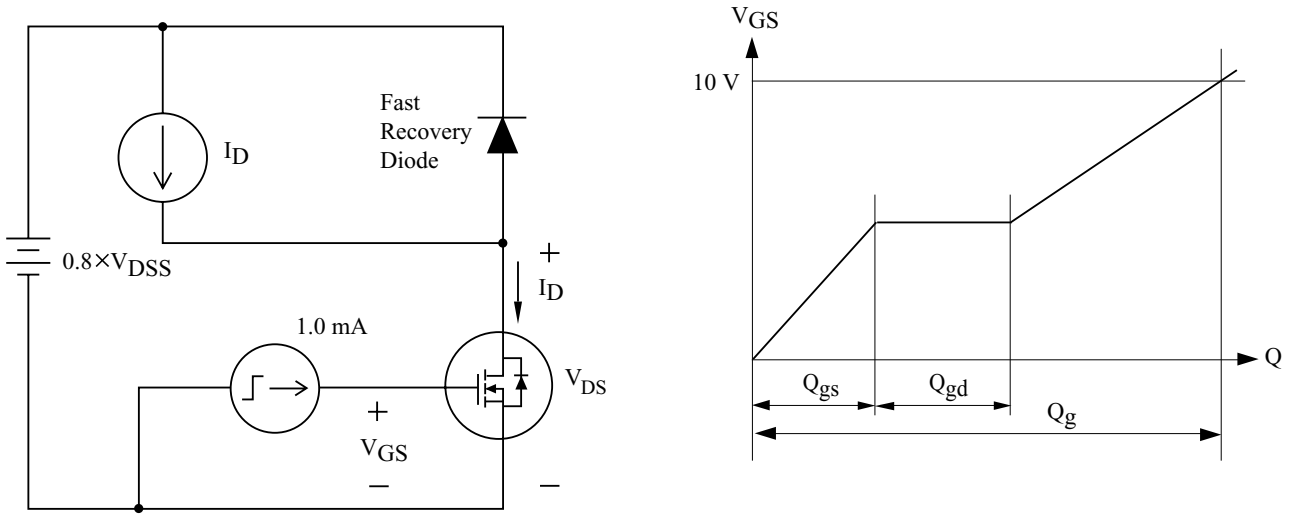

Fig13. Single Pulsed Avalanche Energy

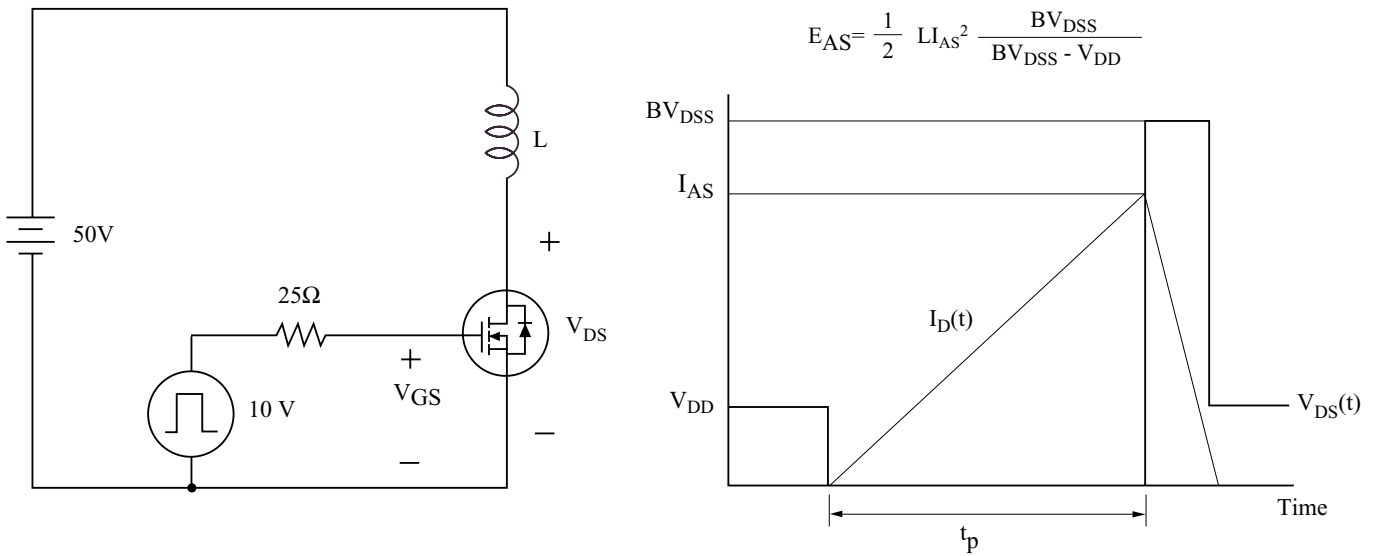

Fig14. Resistive Load Switching

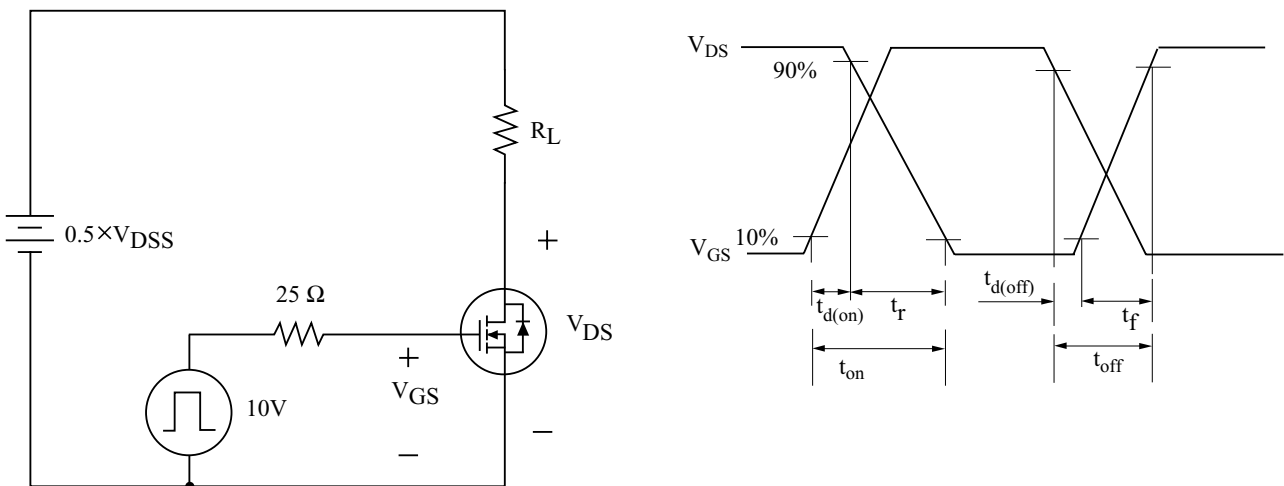

Fig15. Source - Drain Diode Reverse Recovery and dv/dt

