

General Description

This Super Junction MOSFET has better characteristics, such as fast switching time, low on resistance, low gate charge and excellent avalanche characteristics. It is mainly suitable for active power factor correction and switching mode power supplies.

FEATURES

- $V_{DSS}=600V$, $I_D=8A$
- Drain-Source ON Resistance :
 $R_{DS(ON)}(Max)=0.58$ @ $V_{GS}=10V$
- $Qg(typ.)= 16nC$

MAXIMUM RATING (Tc=25 °C)

CHARACTERISTIC	SYMBOL	RATING	UNIT	
Drain-Source Voltage	V_{DSS}	600	V	
Gate-Source Voltage	V_{GSS}	± 30	V	
Drain Current	@T _c =25	8*	A	
	@T _c =100	5*		
	Pulsed (Note1)	I_{DP}		18*
Single Pulsed Avalanche Energy (Note 2)	E_{AS}	125	mJ	
Repetitive Avalanche Energy (Note 1)	E_{AR}	3.7	mJ	
Peak Diode Recovery dv/dt (Note 3)	dv/dt	4.5	V/ns	
Drain Power Dissipation	T _c =25	P_D	37.9	W
	Derate above 25		0.3	W/°C
Maximum Junction Temperature	T _j	150		
Storage Temperature Range	T _{stg}	-55 ~ 150		
Thermal Characteristics				
Thermal Resistance, Junction-to-Case	R _{thJC}	3.3	/W	
Thermal Resistance, Junction-to-Ambient	R _{thJA}	62.5	/W	

* : Drain current limited by maximum junction temperature.

PIN CONNECTION

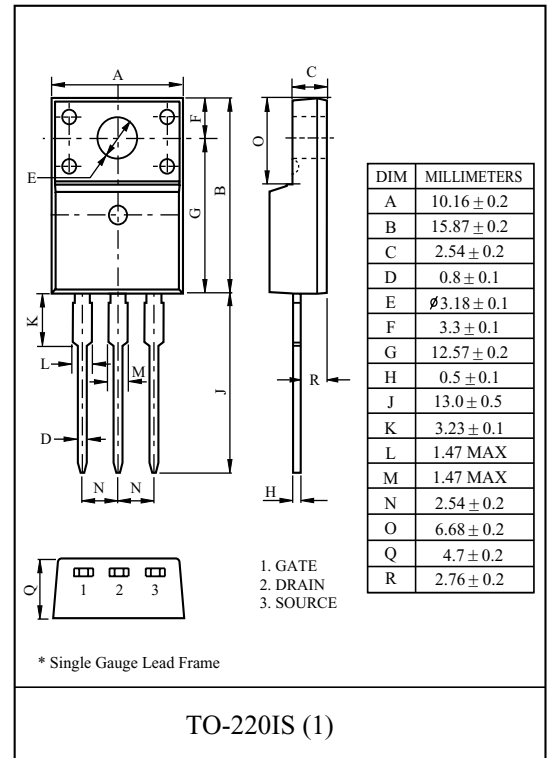
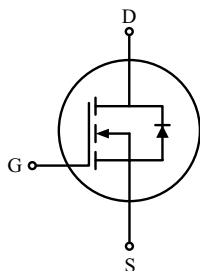

KP8N60F

ELECTRICAL CHARACTERISTICS (Tc=25)

CHARACTERISTIC	SYMBOL	TEST CONDITION	MIN.	TYP.	MAX.	UNIT
Static						
Drain-Source Breakdown Voltage	BV_{DSS}	$I_D=250\ \mu A, V_{GS}=0V$	600	-	-	V
Breakdown Voltage Temperature Coefficient	BV_{DSS}/T_j	$I_D=250\ \mu A$, Referenced to 25	-	0.6	-	V/
Drain Cut-off Current	I_{DSS}	$V_{DS}=600V, V_{GS}=0V$	-	-	10	μA
Gate Threshold Voltage	V_{th}	$V_{DS}=V_{GS}, I_D=250\ \mu A$	2.0	-	4.0	V
Gate Leakage Current	I_{GSS}	$V_{GS}=\pm 30V, V_{DS}=0V$	-	-	± 100	nA
Drain-Source ON Resistance	$R_{DS(ON)}$	$V_{GS}=10V, I_D=4A$	-	0.50	0.58	
Dynamic						
Total Gate Charge	Q_g	$V_{DS}=480V, I_D=8A$ $V_{GS}=10V$ (Note 5)	-	16	-	nC
Gate-Source Charge	Q_{gs}		-	3.1	-	
Gate-Drain Charge	Q_{gd}		-	6.5	-	
Turn-on Delay time	$t_{d(on)}$	$V_{DD}=300V$ $I_D=8A$ $R_G=25$ (Note4,5)	-	19	-	ns
Turn-on Rise time	t_r		-	20	-	
Turn-off Delay time	$t_{d(off)}$		-	49	-	
Turn-off Fall time	t_f		-	15	-	
Input Capacitance	C_{iss}	$V_{DS}=25V, V_{GS}=0V, f=1.0MHz$	-	600	-	pF
Output Capacitance	C_{oss}		-	550	-	
Reverse Transfer Capacitance	C_{rss}		-	2.7	-	
Source-Drain Diode Ratings						
Continuous Source Current	I_S	$V_{GS}<V_{th}$	-	-	8	A
Pulsed Source Current	I_{SP}		-	-	32	
Diode Forward Voltage	V_{SD}	$I_S=8A, V_{GS}=0V$	-	-	1.4	V
Reverse Recovery Time	t_{rr}	$I_S=8A, V_{GS}=0V,$ $dI_S/dt=100A/\mu s$	-	280	-	ns
Reverse Recovery Charge	Q_{rr}		-	2.4	-	μC

Note 1) Repetivity rating : Pulse width limited by junction temperature.

Note 2) $L=3.65mH, I_S=8A, V_{DD}=50V, R_G=25$, Starting $T_j=25$.

Note 3) $I_S=8A, dI/dt=100A/\mu s, V_{DD}=BV_{DSS}$, Starting $T_j=25$.

Note 4) Pulse Test : Pulse width $10\mu s$, Duty Cycle 2% .

Note 5) Essentially independent of operating temperature.

Marking

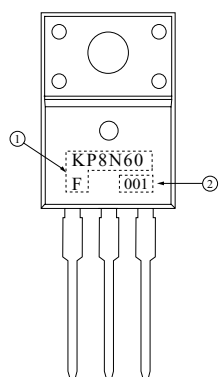

① PRODUCT NAME

② LOT NO

KP8N60F

Fig1. $I_D - V_{DS}$

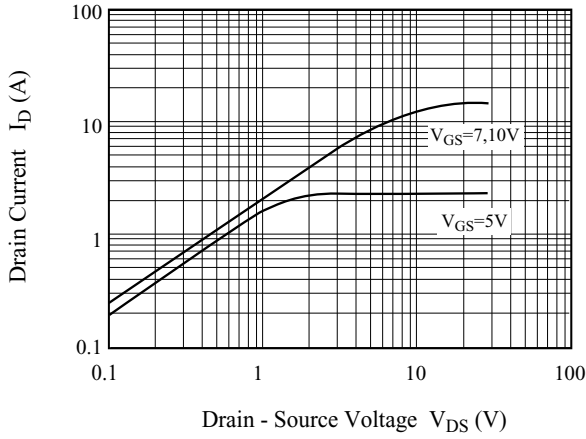

Fig2. $I_D - V_{GS}$

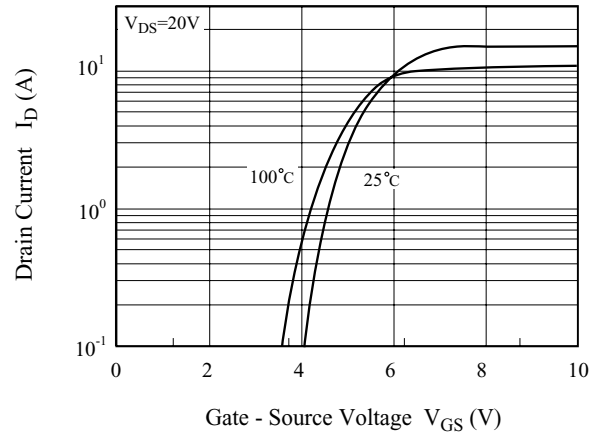

Fig3. $BV_{DSS} - T_j$

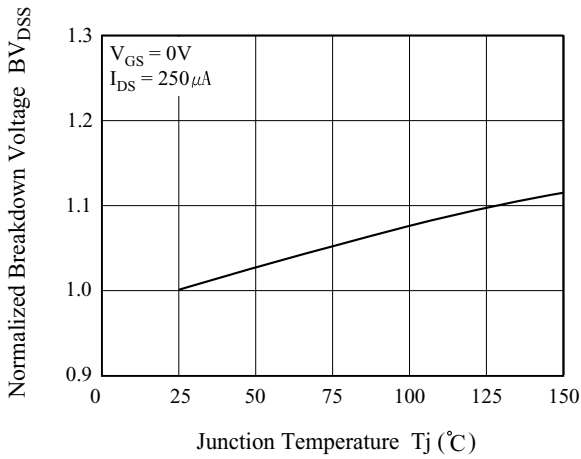

Fig4. $R_{DS(ON)} - I_D$

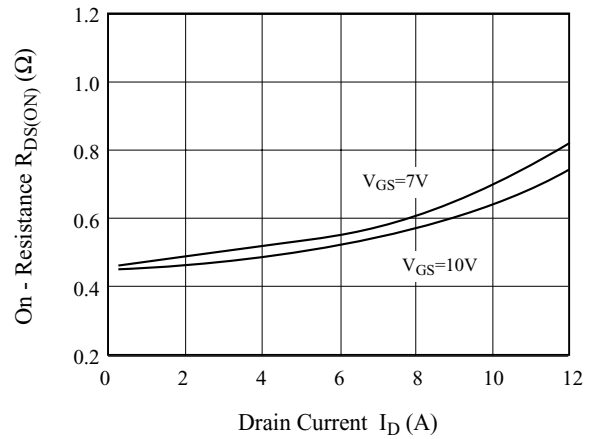

Fig5. $I_S - V_{SD}$

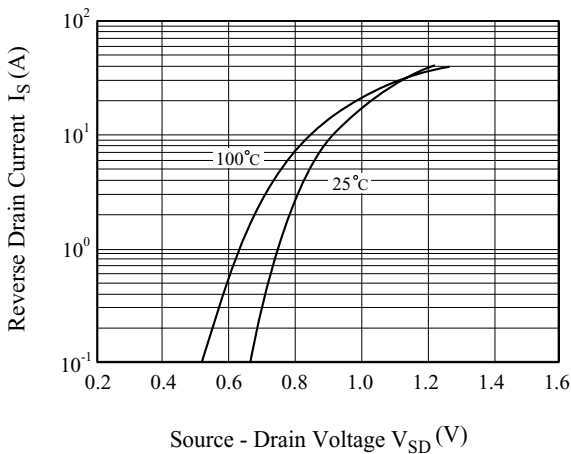
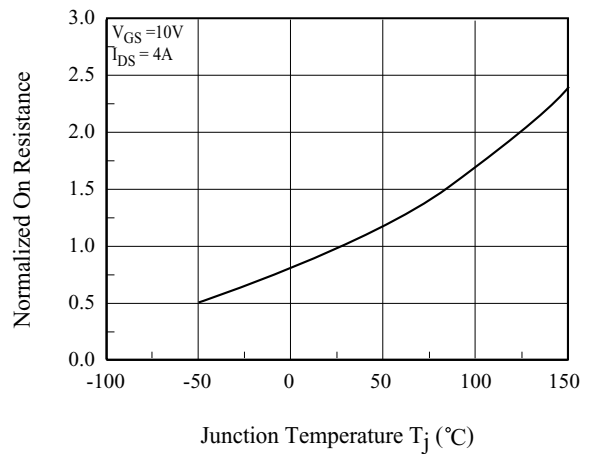

Fig6. $R_{DS(ON)} - T_j$



KP8N60F

Fig 7. C - V_{DS}

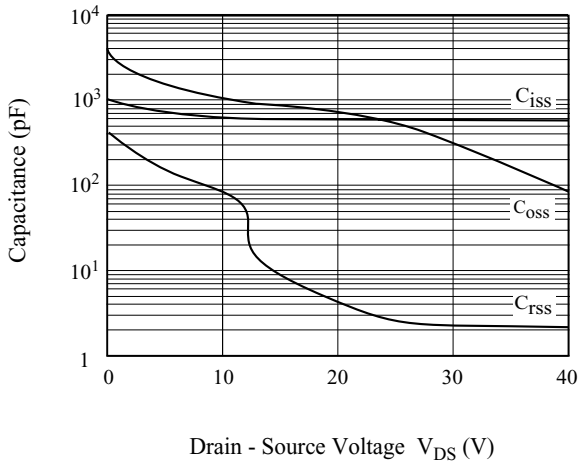

Fig8. Q_g - V_{GS}

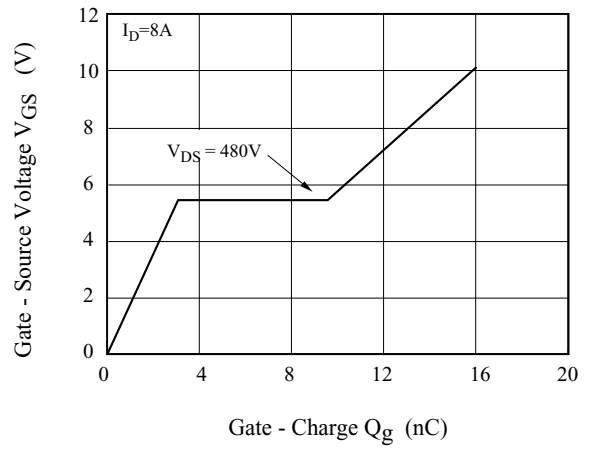

Fig9. Safe Operation Area

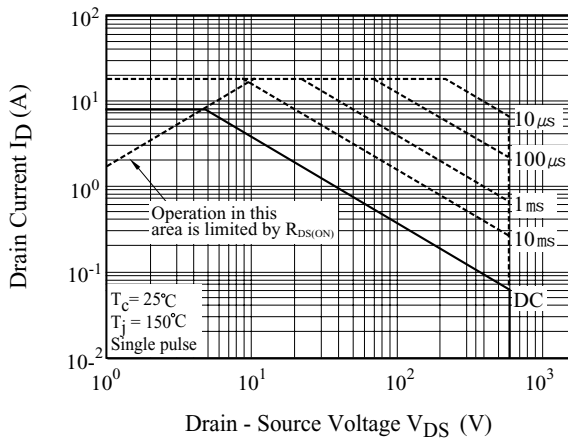
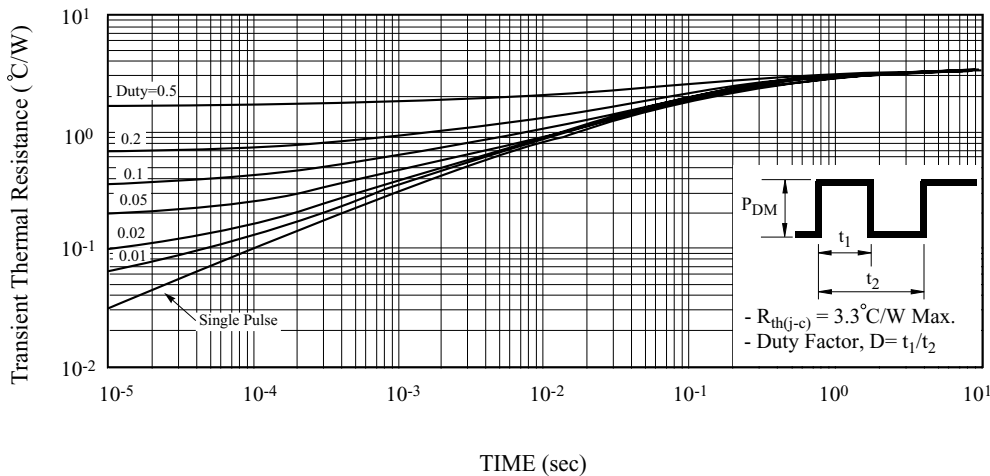

Fig10. Transient Thermal Response Curve



KP8N60F

Fig11. Gate Charge

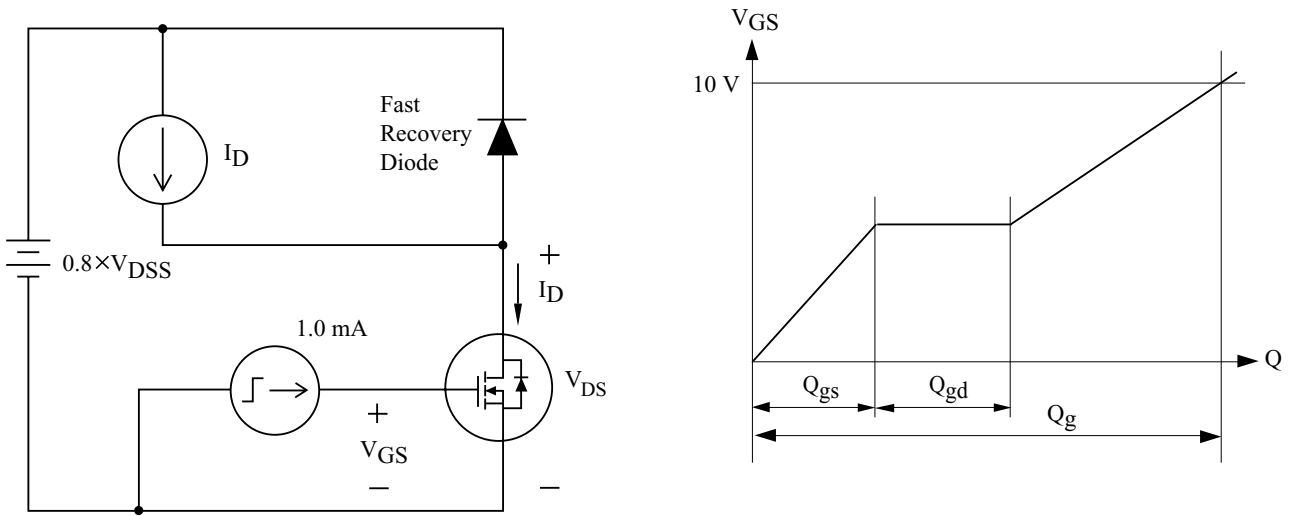

Fig12. Single Pulsed Avalanche Energy

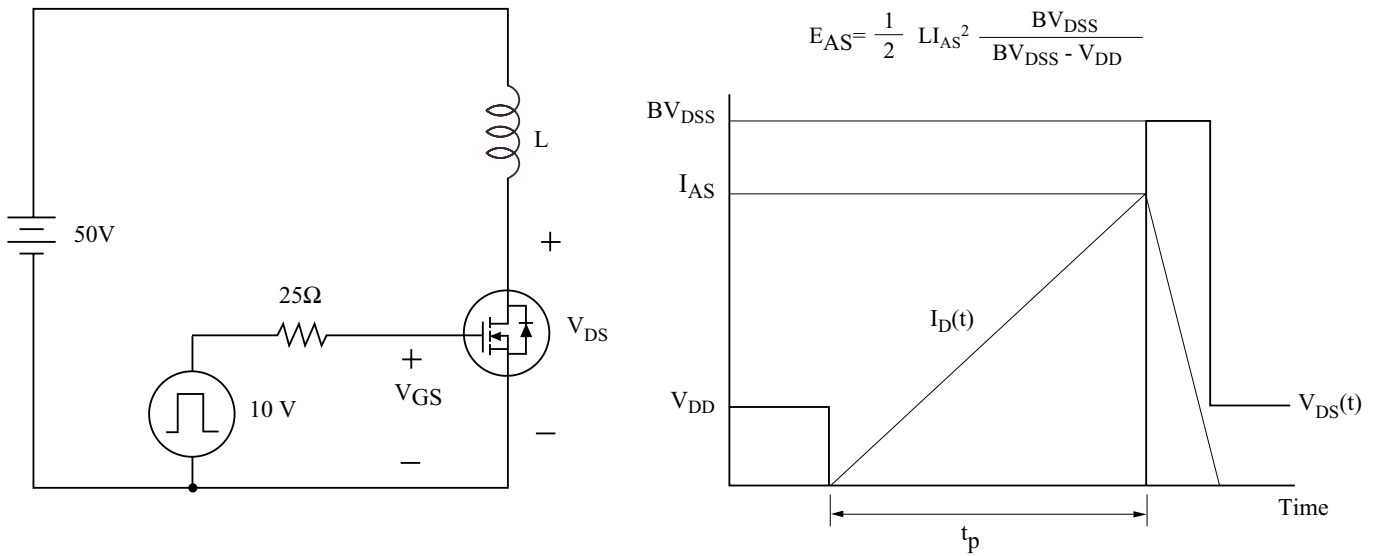
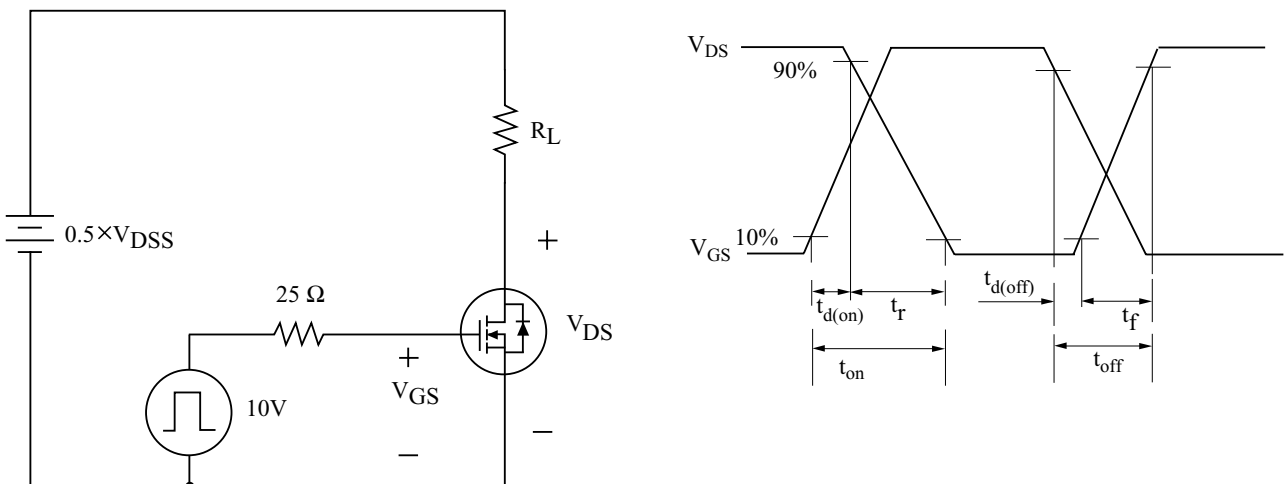

Fig13. Resistive Load Switching



KP8N60F

Fig14. Source - Drain Diode Reverse Recovery and dv/dt

