

● Description

The KPC457 series consist of a LED. It is a high-speed digital output type photocoupler. And it is packaged in a 5pin mini-flat package.

● Schematic

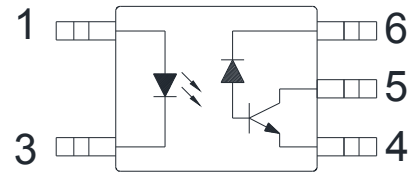

1. Anode
3. Cathode
4. GND(Emitter)
5. Vo (Open collector)
6. Vcc

● Features

1. Pb free and RoHS compliant
2. 5 pin mini-flat package
3. High speed response (tPLH:typ.0.2us, tPHL:typ.0.4us)
4. High instantaneous common mode rejection voltage (C_{MH} : Min. 15KV/us, C_{ML} : Min. -15KV/us)
5. High isolation voltage between input and output (Viso: 3750Vrms)
6. MSL class 1
7. Agency Approvals:
 - UL Approved (No. E169586): UL1577
 - c-UL Approved (No. E169586)
 - VDE Approved (No. 40020973): DIN EN60747-5-5

● Applications

- Computers, measuring instruments, control equipment
- High speed line receivers, high speed logic
- Telephone sets
- Signal transmission between circuits of different potentials and impedances

● **Outside Dimension**

Unit : mm

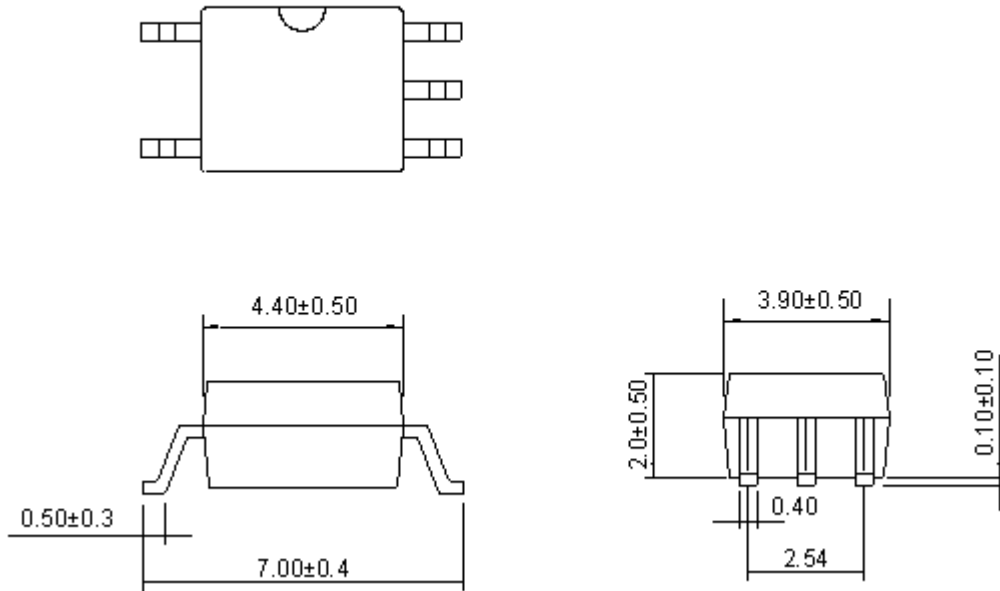

TOLERANCE: ± 0.2 mm

● **Device Marking**

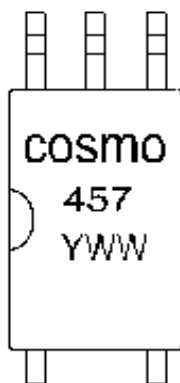

Notes:

cosmo
457
YWW

Y: Year code / WW: Week code

● Absolute Maximum Ratings

(Ta=25°C)

Parameter		Symbol	Rating	Unit
Input	Forward current (*1)	I_F	25	mA
	Peak forward current (*2)	I_{FM}	200	mA
	Reverse voltage	V_R	5	V
	Power dissipation	P_D	45	mW
Output	Supply voltage	V_{CC}	-0.5 to +30	V
	Output voltage	V_{OIL}	-0.5 to +20	V
	Output current	I_{OL}	8	mA
	Power dissipation (*3)	P_O	100	mW
Total power dissipation (*3)		P_{tot}	100	mW
Isolation voltage 1 minute (*4)		V_{iso}	3750	Vrms
Operating temperature		T_{opr}	-55 to +85	°C
Storage temperature		T_{stg}	-55 to +125	°C
Soldering temperature 10 seconds		T_{sol}	260	°C

*1 When ambient temperature goes above 70°C, the power dissipation goes down at 0.8mA/°C.

*2 When ambient temperature goes above 70°C, the power dissipation goes down at 1.5mW/°C.

*3 When ambient temperature goes above 70°C, the power dissipation goes down at 1.8mW/°C.

*4 40 to 80%RH AC for 1 minute=60HZ.

● Electro-optical Characteristics

(Ta= 25°C)

Parameter		Symbol	Conditions	Min.	Typ.	Max.	Unit
Input	Forward voltage	V_F	$I_F=16mA$	-	1.7	1.95	V
	Reverse current	I_R	$V_R=5V$	-	-	10	uA
	Terminal capacitance	C_t	$V=0, f=1MHz$	-	60	250	pF
Output	High level output current (1)	$I_{OH}(1)$	$I_F=0, V_{CC}=5.5V, V_O=5.5V$	-	3	500	nA
	High level output current (2)	$I_{OH}(2)$	$I_F=0, V_{CC}=15V, V_O=15V$	-	-	1.0	uA
	High level output current (3) (*6)	$I_{OH}(3)$		-	-	50	uA
	High level supply current (1)	$I_{CCH}(1)$		$I_F=0, V_{CC}=15V, V_O=Open$	-	0.02	1.0
	High level supply current (2) (*6)	$I_{CCH}(2)$	-		-	2.0	uA
	Low level supply current	I_{CCL}	$I_F=16mA, V_{CC}=15V, V_O=Open$	-	120	-	uA
	Low level supply voltage	V_L	$I_F=16mA, V_{CC}=4.5V, I_O=2.4mA$	-	-	0.4	V
Transfer Characteristics	Current transfer ratio (1)	$CTR(1)$	$I_F=16mA, V_{CC}=4.5V, V_O=0.4V, R_L=1.9K\Omega$	19	-	50	%
	Current transfer ratio (2) (*6)	$CTR(2)$		15	-	-	%
	Isolation resistance	R_{ISO}	$DC=500V, 40\text{ to }60\%RH$	5×10^{10}	1×10^{11}	-	Ω
	Floating capacitance	C_f	$V=0, f=1MHz$	-	0.6	1.0	pF
	“High-->Low” propagation delay time	t_{PHL}	$I_F=16mA, V_{CC}=5V, R_L=1.9K\Omega$	-	0.2	0.8	us
	“High-->Low” propagation delay time	t_{PLH}		-	0.4	0.8	us
	Instantaneous common mode rejection voltage (High level output)	C_{MH}	$I_F=0, V_{CC}=5V, V_{CM}=1.0KV(p-p), R_L=1.9K\Omega$	15	30	-	KV/us



KPC457 Series

5PIN HIGH-SPEED OUTPUT PHOTOCOUPLER

	Instantaneous common mode rejection voltage (High level output)	C_{ML}	$I_F=16mA, V_{CC}=5V,$ $V_{CM}=1.0KV(p-p),$ $R_L=1.9K\Omega$	-15	-30	-	KV/us
--	---	----------	--	-----	-----	---	-------

*5 It shall connect a by-pass capacitor of 0.01uF or more between Vcc (pin 6) and GND(pin 4) near the device ,when it measures transfer characteristics and the output side characteristics.

*6 Ta=0 to 70°C.

Fig.1 Forward Current vs. Ambient Temperature

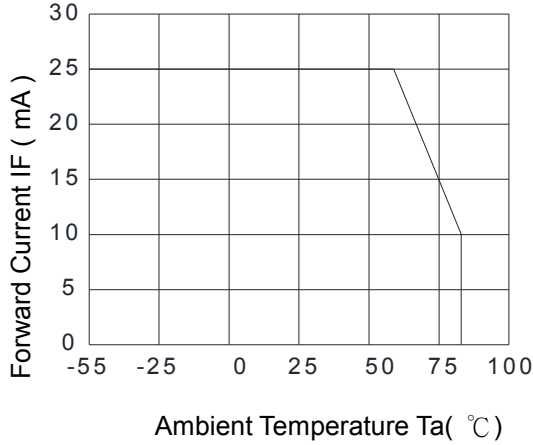

Fig.2 Power Dissipation vs. Ambient Temperature

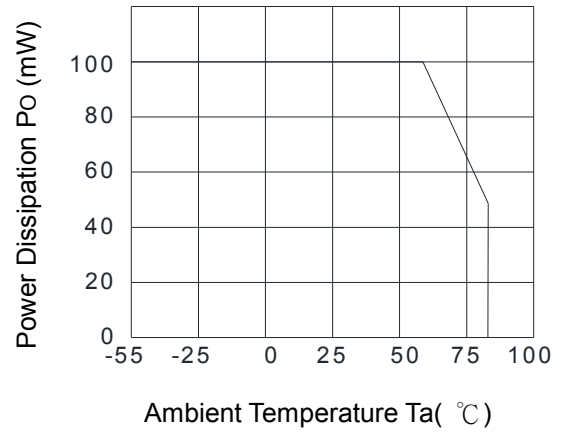

Fig.3 Forward Current vs. Forward Voltage

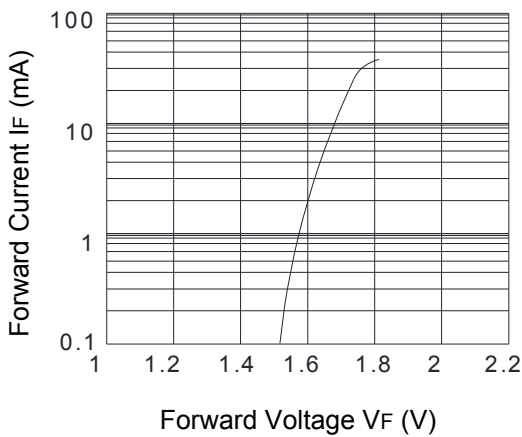

Fig.4 Current Transfer Ratio vs. Forward Current

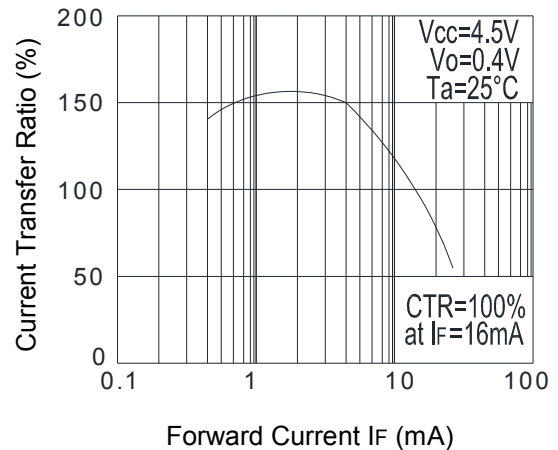

Fig.5 Output Current vs. Output Voltage

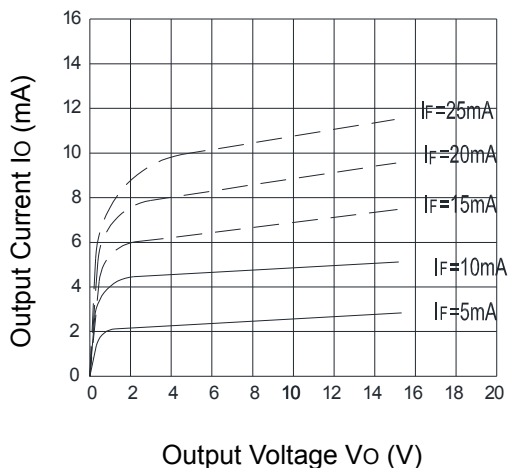

Fig.6 Current Transfer Ratio vs. Ambient Temperature

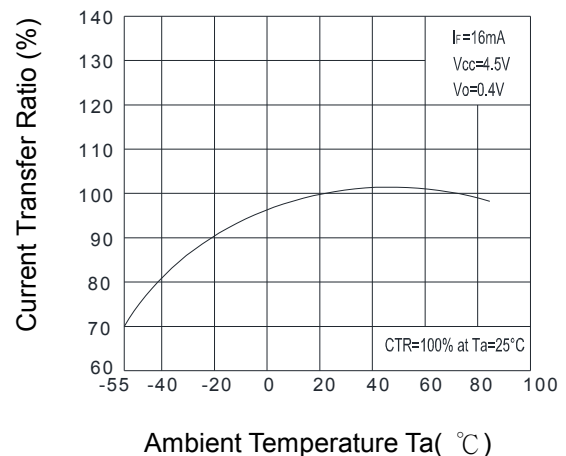

Fig.7 Pulse Width Distortion vs. Ambient Temperature

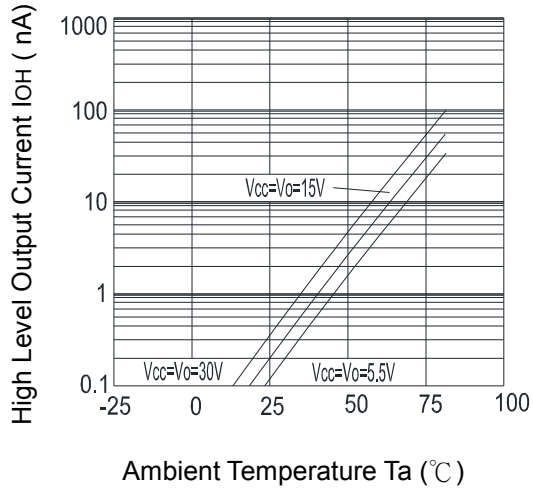
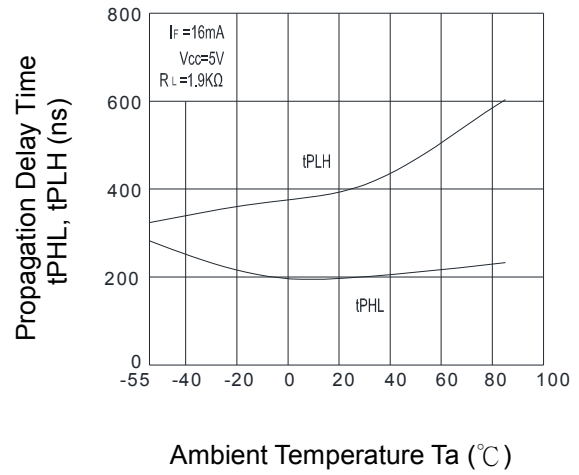

Fig.8 Propagation Delay Time vs. Ambient Temperature



● **Recommended Soldering Conditions**

(a) Infrared reflow soldering :

- Peak reflow soldering : 260°C or below (package surface temperature)
- Time of peak reflow temperature : 10 sec
- Time of temperature higher than 230°C : 30-60 sec
- Time to preheat temperature from 180~190°C : 60-120 sec
- Time(s) of reflow : Two
- Flux : Rosin flux containing small amount of chlorine (The flux with a maximum chlorine content of 0.2 Wt% is recommended.)

Recommended Temperature Profile of Infrared Reflow

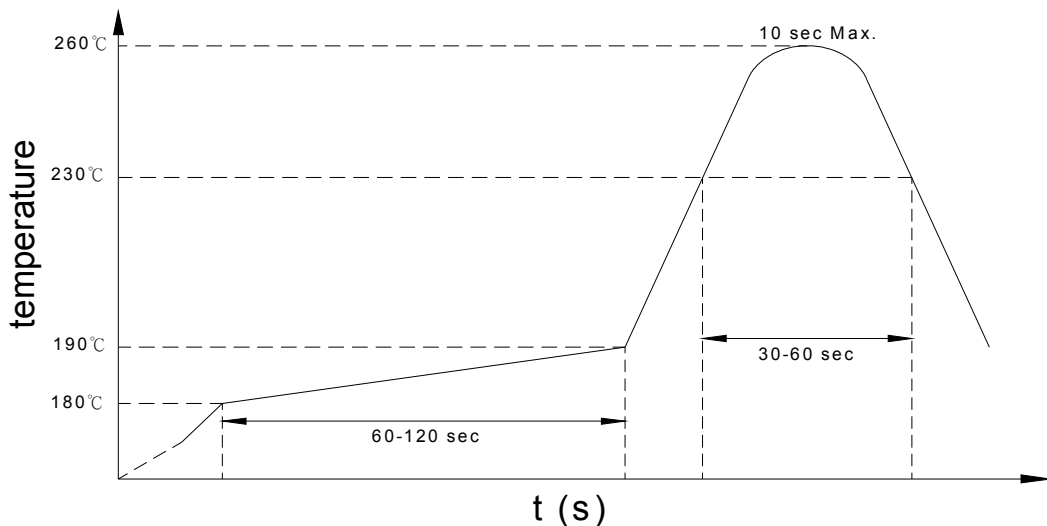

(b) Wave soldering :

- Temperature : 260°C or below (molten solder temperature)
- Time : 10 seconds or less
- Preheating conditions : 120°C or below (package surface temperature)
- Time(s) of reflow : One
- Flux : Rosin flux containing small amount of chlorine (The flux with a maximum chlorine content of 0.2 Wt% is recommended.)

(c) Cautions :

- Fluxes : Avoid removing the residual flux with freon-based and chlorine-based cleaning solvent.
- Avoid shorting between portion of frame and leads.

- **Numbering System**

KPC457 (Z)

Notes:

KPC457 = Part No.

Z = Tape and reel option (TLD, TRU)

Option	Description	Packing quantity
TLD	TLD tape & reel option	3000 units per reel
TRU	TRU tape & reel option	3000 units per reel

- **Recommended Pad Layout for Surface Mount Lead Form**

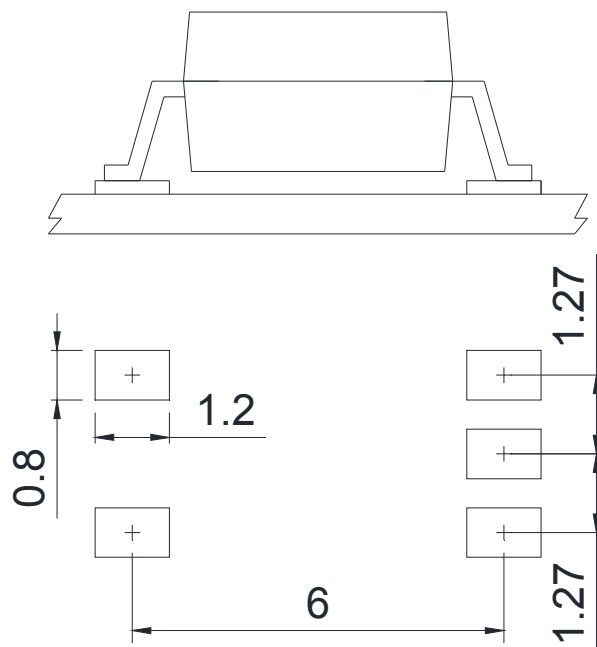

Unit : mm

● SOP Carrier Tape & Reel

Unit: mm

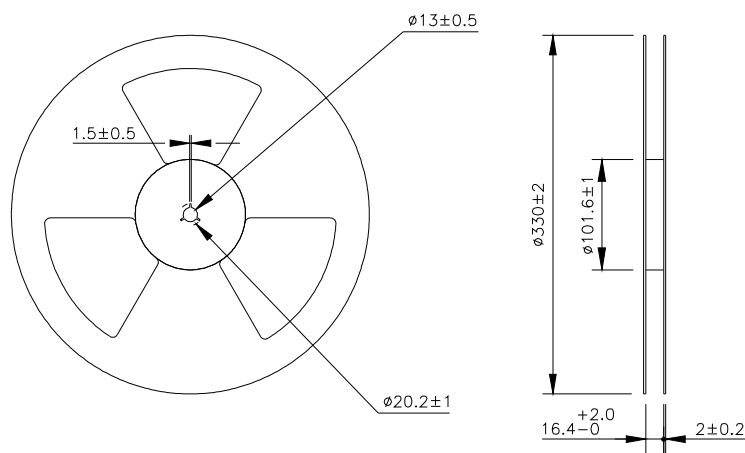
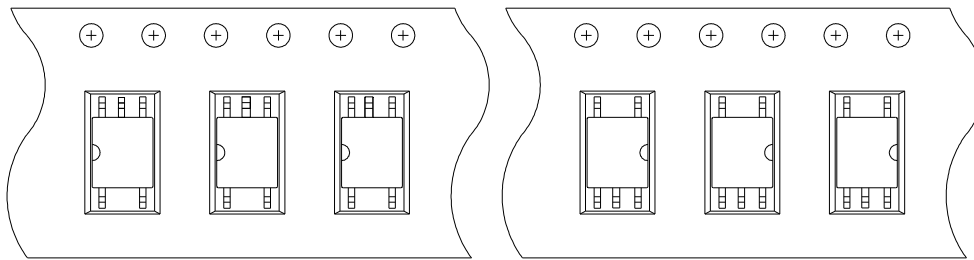
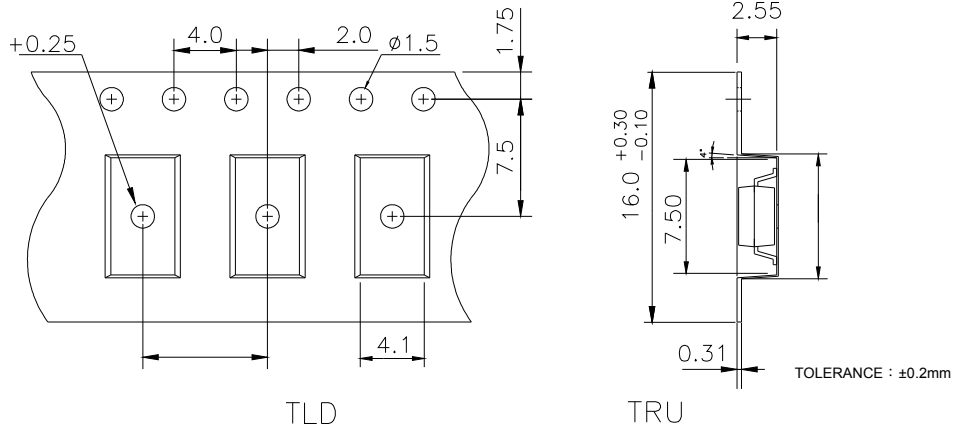

● Application Notice

The content of datasheet is the guidance for product use only. cosmo takes no responsibility to the accuracy of the information provided here. For continuously improving all of products, including quality, reliability, function...etc., cosmo reserves the right to change the specification, characteristics, data, materials, and structure of products without notice. Please contact with cosmo to obtain the latest specification.

It would be required to comply with the absolute maximum ratings listed in the specification. cosmo has no liability and responsibility to the damage caused by improper use of the products.

cosmo products are intended to be designed for use in general electronics application list below:

- a. Personal computer
- b. OA machine
- c. Audio / Video
- d. Instrumentation
- e. Electrical application
- f. Measurement equipment
- g. Consumer electronics
- h. Telecommunication

cosmo devices shall not be used or related with equipment requiring higher level of quality / reliability, or malfunction, or failure which may cause loss of human life, bodily injury, includes, without limitation:

- a. Medical and other life supporting equipments
- b. Space application
- c. Telecommunication equipment (trunk lines)
- d. Nuclear power control
- e. Equipment used for automotive vehicles, trains, ships...etc.

This publication is the property of cosmo. No part of this publication may be reproduced or copied in any form or any means electronically or mechanically for any purpose, in whole or in part without any written permission expressed from cosmo.