

APPROVAL SHEET

DATE: 11/12/2009

cosmo ELECTRONICS CORPORATION	Photolink : KPLT1320M9X	NO.60F00026 SHEET 1 OF 4	REV. 1

FIBER OPTIC TRANSMITTING MODULE FOR DIGITAL AUDIO EQUIPMENT

Features

- TTL interface.
- LED is driven by differential circuit.
- A Self-tapping hole for easy attachment to audio Equipment panels.

Applications

- Audio equipment.
- DVD player.
- Automobile.

Outline Dimensions

(Unit:mm)

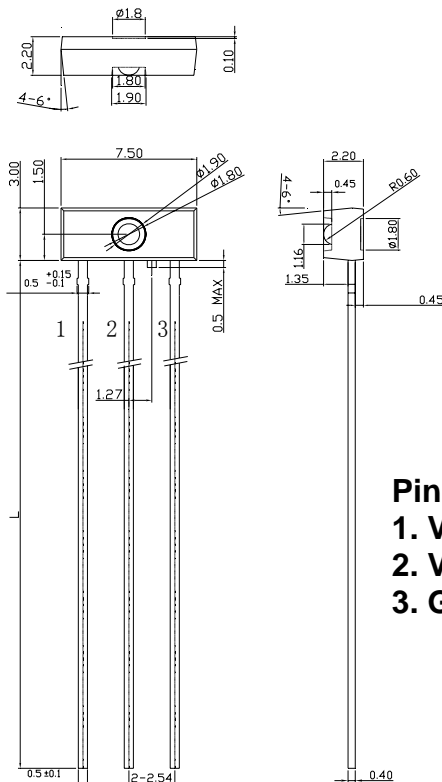

注1. 無指定尺寸公差部分: $\pm 0.2\text{mm}$

Note1. General dimensions tolerance: $\pm 0.2\text{mm}$

注2. 無指定角度公差部分: $\pm 3^\circ$

Note2. General angle tolerance: $\pm 3^\circ$

注3. 無指定Corner R: Max 0.4mm

Note3. General corner: Max 0.4mm

Device Selection Table

Device Name	Pin Length L(mm)
KPLT1320M90	29.0 \pm 0.5(MAX)
KPLT1320M91	28.5 \pm 0.5
KPLT1320M92	23.5 \pm 0.5

Pin Connection

1. Vin
2. Vcc
3. GND

APPROVAL SHEET

DATE: 11/12/2009

cosmo ELECTRONICS CORPORATION	Photolink :	NO.60F00026	REV.
	KPLT1320M9X	SHEET 2 OF 4	1

1. Maximum Ratings (Ta=25°C)

Parameter	Symbol	Rating	Unit
Storage Temperature	T _{stg}	-40~+85	°C
Operating Temperature	T _{opr}	-30~+80	°C
Power Dissipation	P _{max}	120	mW
Supply Voltage	V _{CC}	-0.5~7	V
Input Voltage	V _{IN}	-0.5~V _{CC} +0.5	V
Soldering Temperature	T _{sol}	260 ^(Note 1)	°C

Note 1 : Soldering time \leq 10 seconds (At a distance of 1 mm from the package) .

2. Recommended Operating Conditions

Parameter	Symbol	Min	Typ.	Max	Unit
Supply Voltage	V _{CC}	2.70	5.0	5.5	V
High-Level Input Voltage	V _{IH}	2.0	-	V _{CC}	V
Low-Level Input Voltage	V _{IL}	0	-	0.8	V

3. Electrical and Optical Characteristics (Ta=25°C , V_{CC}=5V)

Parameter	Symbol	Condition	Min	Typ.	Max	Unit
Data Rate		NRZ Signal ^(Note 2)	DC	-	16	Mb/s
Fiber Output Power ^(Note 3)	P _f		-21	-	-15	dBm
Peak Emission Wavelength	λ_p		630	-	690	nm
Current Consumption	I _{CC}		-	5	8	mA
High Level Input Voltage	V _{IH}		2.0	-	-	V
Low Level Input Voltage	V _{IL}		-	-	0.8	V
Low->High Propagation delay time	t _{PLH}				100	ns
High -> Low Propagation delay time	t _{PHL}				100	ns
Pulse Width Distortion	Δtw	8Mbps NRZ Signal	-20	-	20	ns
Jitter Time	Δtj				10	ns

Note 2 : LED is on when input signal is high, and off when it is low.

The duty factor must be maintained between 25 to 75%.

Note 3 : Measure with a standard optical fiber, peak value.

APPROVAL SHEET

DATE: 11/12/2009

cosmo ELECTRONICS CORPORATION	Photolink : KPLT1320M9X	NO.60F00026 SHEET 3 OF 4	REV. 1

4. Measuring method

(1). Measuring method of optical output coupling fiber

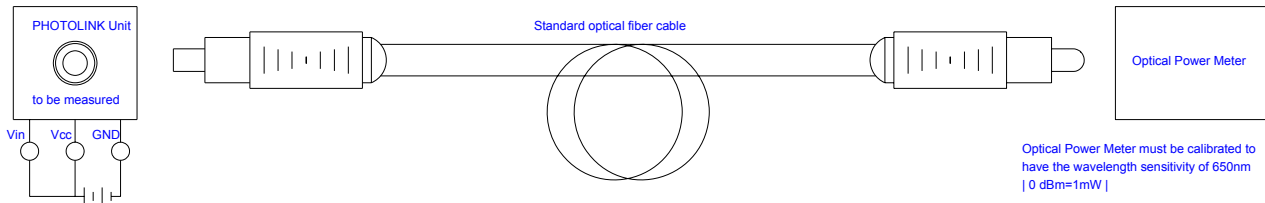

(2). Measuring method of power dissipation current and input voltage

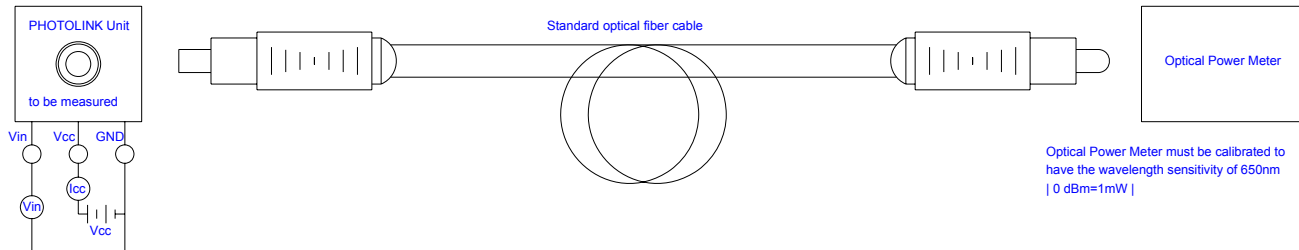

(3). Measuring method of Pulse response

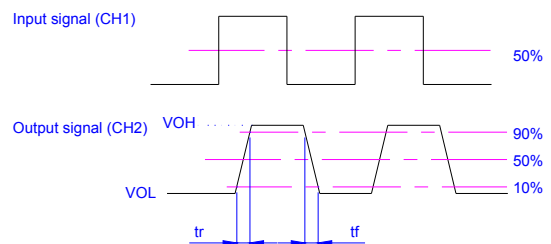
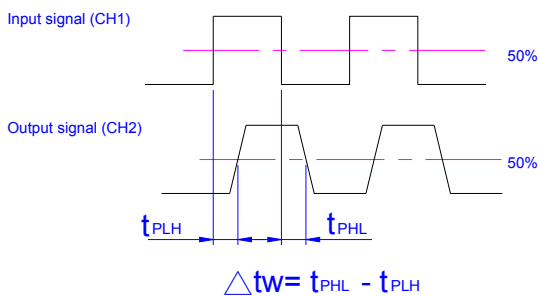
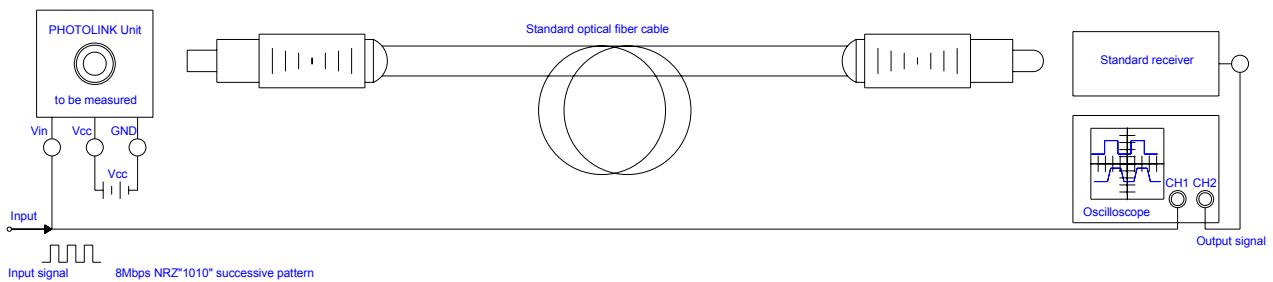

APPROVAL SHEET

DATE: 11/12/2009

cosmo ELECTRONICS CORPORATION	Photolink : KPLT1320M9X	NO.60F00026	REV.
		SHEET 4 OF 4	1

(4).Measuring method of Jitter

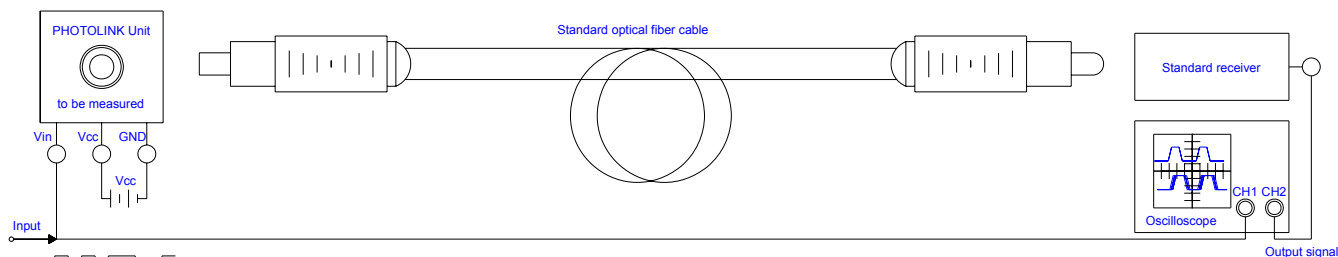

Input signal (CH1)

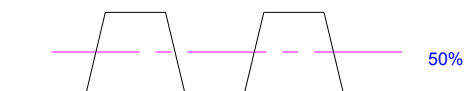

Output signal (CH2)

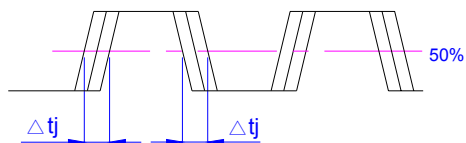

5.Recommended PCB Layout

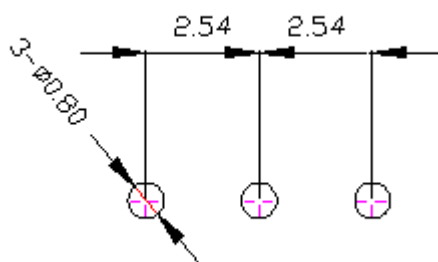

Notes:

1.Unit:mm

2.tolerance:±0.3mm