

JVC

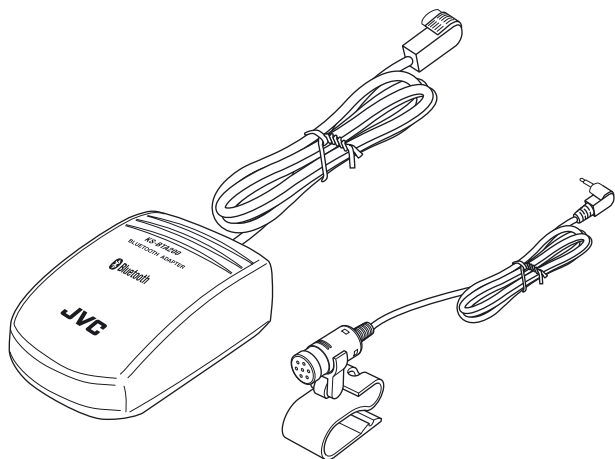

Bluetooth adapter

KS-BTA200



INSTRUCTIONS

For customer Use:

Enter below the Model No. and Serial No. which are located on the top or bottom of the cabinet. Retain this information for future reference.

Model No. _____

Serial No. _____

LVT1640-001A

[K] _____

Declaration of Conformity with regard to the R&TTE Directive 1999/5/EC

C E 0536

English:

Hereby, JVC, declares that this KS-BTA200 is in compliance with the essential requirements and other relevant provisions of Directive 1999/5/EC.

Deutsch:

Hiermit erklärt JVC, dass sich das Gerät KS-BTA200 in Übereinstimmung mit den grundlegenden Anforderungen und den übrigen einschlägigen Bestimmungen der Richtlinie 1999/5/EG befindet. (BMW)

Hiermit erklärt JVC die Übereinstimmung des Gerätes KS-BTA200 mit den grundlegenden Anforderungen und den anderen relevanten Festlegungen der Richtlinie 1999/5/EG befindet. (Wien)

Français:

Par la présente JVC déclare que l'appareil KS-BTA200 est conforme aux exigences essentielles et aux autres dispositions pertinentes de la directive 1999/5/CE.

Nederlands:

Hierbij verklaart JVC dat het toestel KS-BTA200 in overeenstemming is met de essentiële eisen en de andere relevante bepalingen van richtlijn 1999/5/EG.

Dansk:

Undertegnede JVC erklærer herved, at følgende udstyr KS-BTA200 overholder de væsentlige krav og øvrige relevante krav i direktiv 1999/5/EF.

Español:

Por medio de la presente JVC declara que el KS-BTA200 cumple con los requisitos esenciales y cualesquiera otras disposiciones aplicables o exigibles de la Directiva 1999/5/CE.

Ελληνική:

ΜΕ ΤΗΝ ΠΑΡΟΥΣΑ JVC ΔΗΛΩΝΕΙ ΟΤΙ ΚΣ-ΒΤΑ200 ΣΥΜΜΟΡΦΩΝΕΤΑΙ ΠΡΟΣ ΤΙΣ ΟΥΣΙΩΔΕΙΣ ΑΠΑΙΤΗΣΕΙΣ ΚΑΙ ΤΙΣ ΛΟΙΠΕΣ ΣΧΕΤΙΚΕΣ ΔΙΑΤΑΞΕΙΣ ΤΗΣ ΟΔΗΓΙΑΣ 1999/5/ΕΚ.

Italiano:

Con la presente JVC dichiara che questo KS-BTA200 è conforme ai requisiti essenziali ed alle altre disposizioni pertinenti stabilite dalla direttiva 1999/5/CE.

Malti:

Hawnhekk, JVC, jiddikjara li dan KS-BTA200 jikkonforma mal-ħtiġijiet essenzjali u ma provvedimenti oħrajn rilevanti li hemm fid-Dirrettiva 1999/5/EC.

Português:

JVC declara que este KS-BTA200 está conforme com os requisitos essenciais e outras disposições da Directiva 1999/5/CE.

Suomi:

JVC vakuuttaa täten että KS-BTA200 tyyppinen laite on direktiivin 1999/5/EY oleellisten vaatimusten ja sitä koskevien direktiivin muiden ehtojen mukainen.

Svenska:

Härmed intygar JVC att denna KS-BTA200 står i överensstämmelse med de väsentliga egenskapskrav och övriga relevanta bestämmelser som framgår av direktiv 1999/5/EG.

Íslenska:

Hér með lýsir JVC yfir því að KS-BTA200 er í samræmi við grunnkröfur og aðrar kröfur, sem gerðar eru í tilskipun 1999/5/EC.

Norsk:

JVC erklærer herved at utstyret KS-BTA200 er i samsvar med de grunnleggende krav og øvrige relevante krav i direktiv 1999/5/EF.

Cesky:

JVC tímto prohlašuje, že tento KS-BTA200 je ve shodě se základními požadavky a dalšími příslušnými ustanoveními směrnice 1999/5/ES.

Eesti:

Käesolevaga kinnitab JVC seadme KS-BTA200 vastavust direktiivi 1999/5/EÜ põhinõuetele ja nimetatud direktiivist tulenevatele teistele asjakohastele sätetele.

Latviski:

Ar šo JVC deklarē, ka KS-BTA200 atbilst Direktīvas 1999/5/EK būtiskajām prasībām un citiem ar to saistītajiem noteikumiem.

Lietuviu:

Šiuo JVC deklaruoja, kad šis KS-BTA200 atitinka esminius reikalavimus ir kitas 1999/5/EB Direktyvos nuostatas.

Magyar:

Alulírott, JVC nyilatkozom, hogy a KS-BTA200 megfelel a vonatkozó alapvető követelményeknek és az 1999/5/EC irányelv egyéb előírásainak.

Polski:

Niniejszym JVC oświadcza, że KS-BTA200 jest zgodny z zasadniczymi wymogami oraz pozostałymi stosownymi postanowieniami Dyrektywy 1999/5/EC.

Slovensko:

JVC izjavlja, da je ta KS-BTA200 v skladu z bistvenimi zahtevami in ostalimi relevantnimi določili direktive 1999/5/ES.

Slovensky:

JVC týmto vyhlasuje, že KS-BTA200 spĺňa základné požiadavky a všetky príslušné ustanovenia Smernice 1999/5/ES.

Thank you for purchasing a JVC product.

Please read all instructions carefully before operation, to ensure your complete understanding and to obtain the best possible performance from the unit.

INFORMATION (For U.S.A.)

This equipment has been tested and found to comply with the limits for a Class B digital device, pursuant to Part 15 of the FCC Rules. These limits are designed to provide reasonable protection against harmful interference in a residential installation. This equipment generates, uses and can radiate radio frequency energy and, if not installed and used in accordance with the instructions, may cause harmful interference to radio communications. However, there is no guarantee that interference will not occur in a particular installation. If this equipment does cause harmful interference to radio or television reception, which can be determined by turning the equipment off and on, the user is encouraged to try to correct the interference by one or more of the following measures:

- Reorient or relocate the receiving antenna.
- Increase the separation between the equipment and receiver.
- Connect the equipment into an outlet on a circuit different from that to which the receiver is connected.
- Consult the dealer or an experienced radio/TV technician for help.

Caution:

Changes or modifications not approved by JVC could void the user's authority to operate the equipment.

Information for Users on Disposal of Old Equipment



This symbol indicates that the product with this symbol should not be disposed as general household waste at its end-of-life. If you wish to dispose of this product, please do so in accordance with applicable national legislation or other rules in your country and municipality. By disposing of this product correctly, you will help to conserve natural resources and will help prevent potential negative effects on the environment and human health.

This symbol is only valid in the European Union.

Dear Customer,

This apparatus is in conformance with the valid European directives and standards regarding electromagnetic compatibility and electrical safety.

European representative of Victor Company of Japan, Limited is:

JVC Technology Centre Europe GmbH

Postfach 10 05 52

61145 Friedberg

Germany

Introduction



Warnings

- **USE WITH DC 12 V NEGATIVE GROUND VEHICLES.**

If your vehicle is not of 12 V Negative Ground type, a voltage inverter is required, which can be purchased at a JVC car audio (IN-CAR ENTERTAINMENT) dealer.

- This adapter has been designed exclusively for use with JVC's car receivers. Do not use this adapter with any other car receiver.

Precautions

- This adapter is designed for use with Bluetooth devices (cellular phone and audio players).
- Do not raise the volume level too much, as this will block outside sounds, making driving dangerous.
- Do not perform complicated operations while driving; otherwise, it may result in an accident.
- While driving, do not perform any complicated operation such as dialling the numbers, using phone book, etc. When you perform these operations, stop your car in a safe place.
- Some Bluetooth devices may not be connected to this unit depending on the Bluetooth version of the device.
- This unit may not work for some Bluetooth devices.
- Connecting condition may vary depending on circumstances around you.



Introduction

About Bluetooth



Bluetooth is a short-range wireless radio communication technology for the mobile device such as cellular phones, portable PCs, and other devices. The bluetooth devices can be connected without cables and communicate each other.

- The Bluetooth word mark and logos are owned by the Bluetooth SIG, Inc. and any use of such marks by Victor Company of Japan, Limited (JVC) is under licence. Other trademarks and trade names are those of their respective owners.
- The serial number is printed on the label placed on the bottom of the adapter unit.

To send or receive voice and data between this adapter and your Bluetooth device must be within 10 m in distance.

However, the transmission distance may be shorter depending on the circumstances around you.

Bluetooth profile

This adapter supports the following Bluetooth profiles;

- HSP (Headset Profile)
- HFP (Hands-Free Profile)
- A2DP (Advanced Audio Distribution Profile)
- AVRCP (Audio/Video Remote Control Profile)
- SPP (Serial Port Profile)
- OPP (Object Push Profile)

Pairing and PIN Code

When you connect a Bluetooth device to your car receiver through this adapter for the first time, make pairing between the adapter and the device. Pairing allows Bluetooth devices to communicate each other. To make pairing, you may need to enter the PIN (Personal Identification Number) code of your Bluetooth device you want to connect.

General information

- This adapter supports only JVC's Bluetooth-Ready car receivers.
- Refer to the list (included in the box) to see the countries where you may use the Bluetooth® function.

Features

By using this adapter, you can operate Bluetooth devices with your receiver as follows:

- Making/receiving a call
- Calling from phonebook
- Calling by voice command
- Calling from call histories
 - Redial
 - Missed Call
 - Received Call
- Calling by preset numbers
- Receiving the SMS (Short Message Service)/Text Message
- Playback a Bluetooth audio player

Available functions differ depending on the type of your receiver and Bluetooth devices.

Contents

Introduction

Introduction	3
Warnings.....	3
Precautions.....	3
About Bluetooth.....	4
General information	4
Getting Started.....	6
Installation	6
Connecting to the receiver.....	8
Check the type of your receiver.....	9
Menu structures	10

Connection

Bluetooth Connection	12
Selecting a Source	12
Registering a Bluetooth device — Pairing.....	12
Connecting/Disconnecting the device	17

Bluetooth Phone

Bluetooth Phone Operations.....	19
Selecting a Source	19
Receiving a call.....	19
Calling a number in the phone book.....	20
Advanced Operations.....	21
Calling by voice command	21
Calling a number from the call history.....	22
Calling the last call number directly	
— Redial.....	23
Answering a waiting call	23
Using preset numbers.....	24
Calling by entering a phone number	25
Receiving an SMS (Short Message Service)/	
Text Message.....	27
Reading an SMS/Text Message	27

Bluetooth Audio

Bluetooth Audio Operations.....	29
Selecting a source.....	29
Playback operations.....	29

Settings

Other Settings	30
Basic procedure	30
Setting items	31

Others

Troubleshooting.....	32
Specifications	33



Getting Started

Installation

Warning

Avoid installing the adapter unit and the microphone unit in the following places.

- Where they would hinder your safety driving.
- Where they would be exposed to direct sunlight or heat directly from the heater or placed in an extremely hot place.
- Where they would be subject to rain, water splashes or excessive humidity.
- Where they would be subject to dust.
- Where they would be positioned on an unstable place.
- Where they could damage the car's fittings.
- Where radio wave interferes (EX.: trunk, etc.).

Mounting the adapter unit

Wipe clean the selected surface sufficiently, and affix the Velcro tape.

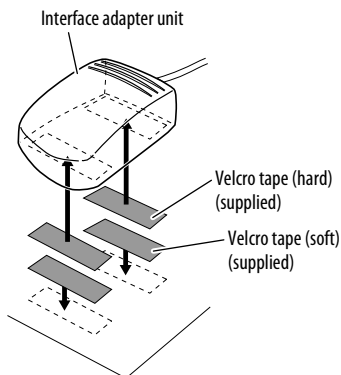

- If the Velcro tape (hard) adheres to the car mat directly, you may install this unit without using the Velcro tape (soft).
- The serial number is printed on the label placed on the bottom of the unit. Do not cover up the label with the velcro tape.

Installing the microphone unit

1 Attach the microphone to the microphone clip.

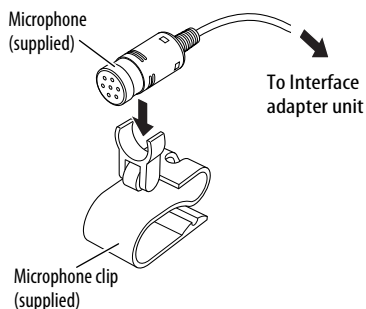

To adjust the microphone angle

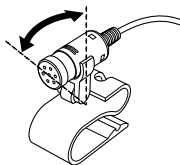

2 Install the microphone unit.

To install on the sun visor

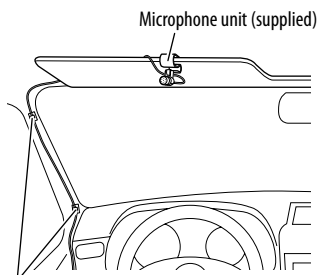

Secure the microphone cord using cord clamps (not supplied) if necessary.

To install on the steering column

Install the microphone unit on the top side of the steering column.

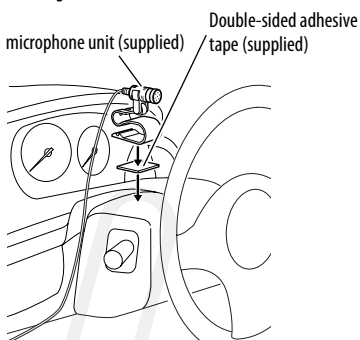

Getting Started

Connecting to the receiver

Typical connection

Turn off the power to the receiver and turn off the vehicle's ignition switch before connecting or disconnecting the unit.

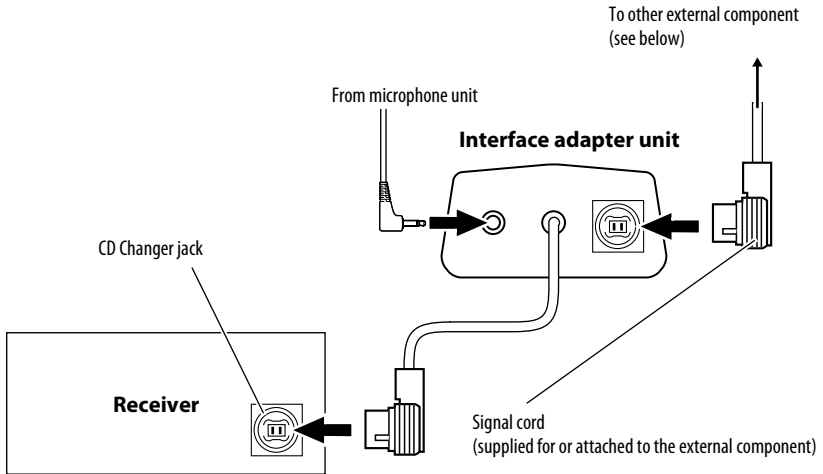



- You can connect the following external components to this adapter;
 - CD Changer
 - SIRIUS Satellite radio
 - XM Satellite radio
 - DAB tuner
 - Interface adapter for iPod
 - D.player interface adapter
 - Line Input Adapter
 - Aux Input Adapter
- See also the installation manual supplied with your receiver.

Checking the type of your receiver

Operating procedures through a receiver are different depending on the type of the receiver.

Check the type of your receiver by the chart below.

- If your answer is "Yes," follow .
- If your answer is "No," follow .

Is your receiver KD-NX5000?  Type A



Is your receiver equipped with the built-in monitor?  Type B



Is your receiver equipped with the 3 Dimensional Liquid Crystal Display?  Type C



Type D

- Menu operations are different depending on the type of your receiver.
For details, see also the instructions supplied with your receiver.

Example: type of the receiver

Type A

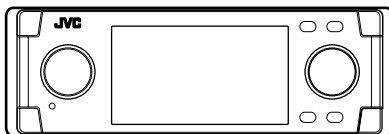

Type B

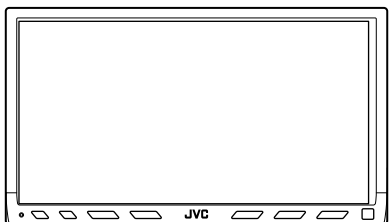
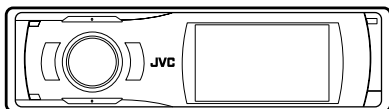

Type C

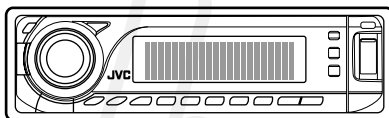

Type D

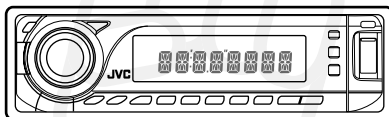

Getting Started

Menu structures

Indication language

In this manual, English indications are used for purpose of explanation. You can change the indication language to other than English for some receivers. Refer to the instruction manual supplied with your receiver.

Bluetooth Phone

Dial / Dial Menu / DIAL *1	Select the method to make a call.
Redial / REDIAL *2	Select a phone number from the list of the phone numbers you have dialed. page 22.
Received Calls / RECEIVE *2	Select a phone number from the list of the received calls. page 22.
Phonebook / PH BOOK *2	Select a name, then phone number from the phone book of the connected cellular phone. page 20.
Missed Calls / MISSED *2	Select a phone number from the list of the missed calls. page 22.
Phone number / NUMBER	Enter the phone number. page 25.
Voice / Voice Dialing / VOICE *3	You can call by voice command. page 21.
Message *1, 2, 4	You can read a message from the following message histories.
Unread	Messages you have not read. page 27.
Read	Messages you have read. page 27.
Unsent	Messages you have not sent. page 27.
Sent	Messages you have sent. page 27.
Open / OPEN *5	Make the unit ready to establish a new Bluetooth connection. Select this when establishing a Bluetooth connection with a device for the first time, from the device . page 12.
Search / SEARCH *5	Make the unit ready to establish a new Bluetooth connection. Select this when establishing a Bluetooth connection with a device for the first time, from the unit . The unit searches for available new devices. page 14.
Special Device / SPECIAL *5	Shows the list of Bluetooth devices which require some special procedure to establish Bluetooth connection. Select a device you want to connect. page 15.
Connection / Connect / CONNECT *6	After selecting a device from among the registered devices, establish the connection with it. page 17.
Disconnection / Disconnect / DISCONNCT *1	Disconnect the current device before connecting another device. page 18.
Delete Pair / DELETE *6	Delete the registered devices. page 16.



Setup / Settings / SETTING	Change the settings. ⓘ page 30.	
	Auto Connect / AUTO CNT	You can set to connect a Bluetooth device automatically when the receiver is turned on.
	Auto Answer / AUTO ANS*7	You can set the receiver to receive or reject the incoming calls automatically.
	Message Info *2, 4, 7	You can set the receiver inform when you receive an SMS/Text Message.
	Microphone Level / Mic Setting / MIC SET *7	Adjust a microphone volume.
Version / VERSION *8	Display the software and hardware versions.	

Bluetooth Audio

Open / OPEN *5	Make the unit ready to establish a new Bluetooth connection. Select this when establishing a Bluetooth connection with a device for the first time, from the device . ⓘ page 12.	
Search / SEARCH *5	Make the unit ready to establish a new Bluetooth connection. Select this when establishing a Bluetooth connection with a device for the first time, from the unit . The unit searches for available new devices. ⓘ page 14.	
Special Device / SPECIAL *5	Shows the list of Bluetooth devices which requires some special procedure to establish Bluetooth connection. Select a device you want to connect. ⓘ page 15.	
Connection / Connect / CONNECT *6	After selecting a device from among the registered devices, establish the connection with it. ⓘ page 17.	
Disconnection / Disconnect / DISCNCT *1	Disconnect the current device before connecting another device. ⓘ page 18.	
Delete Pair / DELETE *6	Delete the registered devices. ⓘ page 16.	
Setup / Settings / SETTINGS	Change the settings. ⓘ page 30.	
	Version / VERSION *8	Display the software and hardware versions.

*1 Selectable only when the device is connected.

*2 Selectable only when your cellular phone is equipped with the function.

*3 Selectable only when your cellular phone is equipped with the voice recognition system.

*4 Excluding type D.

*5 Selectable only when "New Device" is selected.

*6 Selectable only when the registered device is selected.

*7 Not selectable for "New Device".

*8 If you wish to receive more information about Bluetooth, visit our JVC web site.

Bluetooth Connection

- For details of the menu operations, refer to the instruction manual supplied with your receiver.
- Indications on the display (monitor) and button names vary among the receivers.

ex. **SOURCE: SRC** ■: ■ / **BACK MENU: AV MENU, AV Menu**
Bluetooth Phone: Bluetooth PHONE, BT-PHONE
New Device: New device, NEW DEVICE

Preparation: Turn on the Bluetooth function of the Bluetooth device.

Selecting a source

Before you connect a Bluetooth device, change the source to the Bluetooth device.

for Type A

Press and hold **MENU** to call up the Bluetooth menu or press **SRC** repeatedly to select "**Bluetooth Audio**."

for Type B/Type C/Type D

You can select "**Bluetooth Phone**" and "**Bluetooth Audio**" as the source.

Press **SOURCE** repeatedly to select "**Bluetooth Phone**" or "**Bluetooth Audio**."

Registering a Bluetooth device — Pairing

When you connect a Bluetooth device for the first time, register and make pairing between the unit and the device.

- Pairing may not be possible with some Bluetooth devices.

To connect from the other Bluetooth device

Use "**Open**" to establish connection with a Bluetooth device from the device.

for Type A

- 1 Display "**Bluetooth Phone**" screen or select "**Bluetooth Audio**" as the source.
- 2 Press **▲/▼** to select "**New Device**."
- 3 Display the menu, then select "**Mode**" ⇨ "**Open**."
- 4 Press **◀◀/▶▶|/▲/▼** to enter the PIN (Personal Identification Number) Code, then select "**Connect**."

◀◀/▶▶|/▲/▼:

Select a number.

ENT: Enter the number.

- Refer to the instruction manual supplied with your receiver.
- You can enter any number you like (1-digit to 16-digit numbers).
- Some devices have their own PIN code. Enter the specified PIN code to the unit.

- 5 Use the Bluetooth device to search for the unit.

- Enter the same PIN code (as entered in the above step) on the device to be connected.

"**Connected** (and the device name)" appears on the display.

for Type B

1 While **“Bluetooth Phone”** or **“Bluetooth Audio”** is selected as the source, select **“New Device.”**

2 Display the menu, then select **“Bluetooth”** ⇒ **“Open.”**

3 Enter the PIN (Personal Identification Number) Code.

Refer to the instruction manual supplied with your receiver.

- You can enter any number you like (1-digit to 16-digit numbers).
- Some devices have their own PIN code. Enter the specified PIN code to the unit.

4 Use the Bluetooth device to search for the unit.

- Enter the same PIN code (as entered in the above step) on the device to be connected.

“Connected (and the device name)” appears on the display.

for Type C

1 While **“Bluetooth Phone”** or **“Bluetooth Audio”** is selected as the source, select **“New Device.”**

2 Press **MODE**, then select **“Open.”**

3 Use the following buttons to enter the PIN (Personal Identification Number) Code.

◀◀/▶▶: Move the entry position.

▲/▼: Select a number.

5: Delete all entries.

1: Enter the number.

- You can enter any number you like (1-digit to 16-digit numbers).
- Some devices have their own PIN code. Enter the specified PIN code to the unit.

4 Use the Bluetooth device to search for the unit.

- Enter the same PIN code (as entered in the above step) on the device to be connected.

“Connected (and the device name)” appears on the display.

for Type D

1 While **“Bluetooth Phone”** or **“Bluetooth Audio”** is selected as the source, press **◀◀/▶▶** to select **“NEW.”**

2 Press **▼**, then select **“OPEN.”**

3 Use the following buttons to enter the PIN (Personal Identification Number) Code.

◀◀/▶▶: Move the entry position.

VOLUME +/- (Control dial):

Select a number.

▼: Enter the number.

- You can enter any number you like (1-digit to 16-digit numbers).
- Some devices have their own PIN code. Enter the specified PIN code to the unit.

4 Use the Bluetooth device to search for the unit.

- Enter the same PIN code (as entered in the above step) on the device to be connected.

“CONNECT (and the device name)” appears on the display.

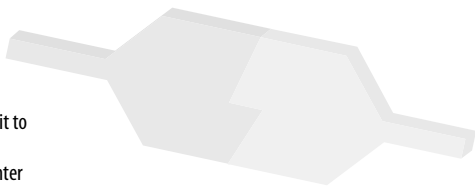

Bluetooth Connection

Registering a Bluetooth device — Pairing (continued)

- To connect an available device from the unit

Use “**Search**” to establish connection with a Bluetooth device from the unit.

for Type A

- 1 Display “**Bluetooth Phone**” screen or select “**Bluetooth Audio**” as the source.
- 2 Press ▲/▼ to select “**New Device.**”
- 3 Display the menu, then select “**Mode**” ⇒ “**Search.**”
The unit searches for the devices and displays the list of the available devices.
- 4 Select a device name you want to connect.
- 5 Press |◀◀/▶▶|/▲/▼ to enter the PIN (Personal Identification Number) Code of the device to be connected, then select “**Connect.**”

|◀◀/▶▶|/▲/▼:

Select a number.

ENT: Enter the number.

- Refer to the instruction manual supplied with your receiver.

“**Connected** (and the device name)” appears on the display.

for Type B

- 1 While “**Bluetooth Phone**” or “**Bluetooth Audio**” is selected as the source, select “**New Device.**”

- 2 Display the menu, then select “**Bluetooth**” ⇔ “**Search.**”

The unit searches for the devices and displays the list of the available devices.

- 3 Select a device name you want to connect.

- 4 Enter the PIN (Personal Identification Number) Code of the device to be connected.

- Refer to the instruction manual supplied with your receiver.

“**Connected** (and the device name)” appears on the display.

for Type C

- 1 While “**Bluetooth Phone**” or “**Bluetooth Audio**” is selected as the source, select “**New Device.**”

- 2 Press **MODE**, then select “**Search.**”

The unit searches for the devices and displays the list of the available devices.

- 3 Select a device name you want to connect.

4 Use the following buttons to enter the PIN (Personal Identification Number) Code of the device to be connected.

◀◀/▶▶: Move the entry position.

▲/▼: Select a number.

5: Delete all entries.

1: Enter the number.

“**Connected** (and the device name)” appears on the display.

for Type D

1 While “Bluetooth Phone” or “Bluetooth Audio” is selected as the source, press ◀◀/▶▶ to select “NEW.”

2 Press ▼, then select “SEARCH.”

The unit searches for the devices and displays the list of the available devices.

3 Select a device name you want to connect.

4 Use the following buttons to enter the PIN (Personal Identification Number) Code of the device to be connected.

◀◀/▶▶: Move the entry position.

VOLUME +/- (Control dial):

Select a number.

▼: Enter the number.

“**CONNECT** (and the device name)” appears on the display.

To connect a special device

Some Bluetooth devices require some special procedures to establish Bluetooth connection for the first time. You need to select the device name for those Bluetooth devices before you register it.

for Type A

1 Display “Bluetooth Phone” screen or select “Bluetooth Audio” as the source.

2 Press ▲/▼ to select “New device.”

3 Display the menu, then select “Mode” ⇒ “Special Device.”

The list of special devices appears on the display.

4 Select a device name you want to connect.

5 Connect the selected device using “Open (page 12)” or “Search (page 14).”

for Type B

1 While “Bluetooth Phone” or “Bluetooth Audio” is selected as the source, select “New device.”

2 Display the menu, then select “Bluetooth” ⇒ “Special Device.”

The list of special devices appears on the display.

3 Select a device name you want to connect.

4 Connect the selected device using “Open (page 13)” or “Search (page 14).”



Bluetooth Connection

Registering a Bluetooth device — Pairing (continued)

for Type C

- 1 While **"Bluetooth Phone"** or **"Bluetooth Audio"** is selected as the source, select **"New device."**
- 2 Press **MODE**, then select **"Special Device."**
The list of special devices appears on the display.
- 3 Select a device name you want to connect.
- 4 Connect the selected device using **"Open (page 13)"** or **"Search (page 14)."**

for Type D

- 1 While **"Bluetooth Phone"** or **"Bluetooth Audio"** is selected as the source, press **|◀◀/▶▶|** to select **"NEW."**
- 2 Press **▼**, then select **"SPECIAL."**
- 3 Select a device name you want to connect.
- 4 Connect the selected device using **"OPEN (page 13)"** or **"SEARCH (page 14)."**

To delete the registered device

You can register up to five Bluetooth devices. If you want to connect a 6th device, delete one of the registered devices.

for Type A

- 1 Display **"Bluetooth Phone"** screen or select **"Bluetooth Audio"** as the source.
- 2 Press **▲/▼** to select a registered device you want to delete.
- 3 Display the menu, then select **"Mode"** ⇒ **"Delete Pair."**
- 4 Select **"Yes"** to delete the device.
 - If you select "No," the procedure is canceled.

for Type B

- 1 While **"Bluetooth Phone"** or **"Bluetooth Audio"** is selected as the source, select a registered device you want to delete.
- 2 Display the menu, then select **"Bluetooth"** ⇒ **"Delete Pair."**
- 3 Select **"Yes"** to delete the device.
 - If you select "No," the procedure is canceled.

for Type C

- 1 While **"Bluetooth Phone"** or **"Bluetooth Audio"** is selected as the source, select a registered device you want to delete.
- 2 Press **MODE**, then select **"Delete Pair."**
- 3 Select **"Yes"** to delete the device.
 - If you select "No," the procedure is canceled.

for Type D

- 1 While **"Bluetooth Phone"** or **"Bluetooth Audio"** is selected as the source, press |◀◀/▶▶| to select a registered device you want to delete.
- 2 Press ▼, then select **"DELETE."**
- 3 Select **"YES"** to delete the device.
 - If you select "NO," the procedure is canceled.

Connecting/Disconnecting the device

■ To connect a device manually

Only one device can be connected at a time for each source ("Bluetooth Phone" and "Bluetooth Audio").

for Type A

- 1 Display **"Bluetooth Phone"** screen or select **"Bluetooth Audio"** as the source.
- 2 Press ▲/▼ to select a registered device.
- 3 Select **"Mode"** ⇨ **"Connection"** to connect a selected device.

for Type B

- 1 While **"Bluetooth Phone"** or **"Bluetooth Audio"** is selected as the source, select a registered device.
- 2 Display the menu, then select **"Bluetooth"** ⇨ **"Connect"** to connect a selected device.

for Type C

- 1 While **"Bluetooth Phone"** or **"Bluetooth Audio"** is selected as the source, use ▲/▼ to select a registered device.
- 2 Press **MODE**, then select **"Connect"** to connect a selected device.



Bluetooth Connection

Connecting/Disconnecting the device (continued)

for Type D

- 1 While **"Bluetooth Phone"** or **"Bluetooth Audio"** is selected as the source, press |◀◀/▶▶| to select a registered device.
- 2 Press ▼, then select **"CONNECT"** to connect a selected device.

Note

You can connect the Bluetooth cellular phone automatically when the receiver is turned on.

See "Auto Connect" on page 31.

To disconnect a device

You can disconnect a Bluetooth device.

for Type A

- 1 Display **"Bluetooth Phone"** screen or select **"Bluetooth Audio"** as the source.
- 2 Select **"Mode"** ⇔ **"Disconnect"** to disconnect a device.

for Type B

- 1 Select **"Bluetooth Phone"** or **"Bluetooth Audio"** as the source.
- 2 Display the menu, then select **"Bluetooth"** ⇔ **"Disconnect"** to disconnect a device.

for Type C

- 1 Select **"Bluetooth Phone"** or **"Bluetooth Audio"** as the source.
- 2 Press **MODE**, then select **"Disconnect"** to disconnect a device.

for Type D

- 1 Select **"Bluetooth Phone"** or **"Bluetooth Audio"** as the source.
- 2 Press ▼, then select **"DISCONNCT"** to disconnect a device.

Bluetooth Phone Operations

- Before you use a Bluetooth device with your receiver, connect a Bluetooth device. See “Bluetooth Connection” on page 12.
- When the sound is stopped or interrupted during the use of a Bluetooth device, try the following remedies.
 - Turn Off, then turn On the power to the receiver.
 - (When sound is not yet restored,) Connect the device again. See “Connecting/Disconnecting the device” on page 17.
- For details of the menu operations, refer to the instruction manual supplied with your receiver.
- Indications on the display (monitor) and button names vary among the receivers.
ex. **SOURCE: SRC** ■: ■ / **BACK MENU: AV MENU, AV Menu**
Bluetooth Phone: Bluetooth PHONE, BT-PHONE
New Device: New device, NEW DEVICE

Selecting a source

Before you operate the Bluetooth phone function, change the source to “**Bluetooth Phone.**”

for Type A

Press and hold **MENU** to call up the Bluetooth menu or press **PHONE** on the remote controller.

for Type B/Type C/Type D

Press **SOURCE** repeatedly to select “**Bluetooth Phone.**”

Receiving a call

If you receive a call, “**Receiving Call** (and name, phone number if acquired)” appears on the display.

Press one of the following buttons.

The source changes to Bluetooth Phone and you can receive the incoming call.

Type A

Any key (except **⏻/VATT, +/-, MAP, SRC** and **▲**.)

Type B/Type C/Type D

Any key (except **⏻/VATT** and **VOL +/-**.)

for the Touch Panel model

You can also press the message “**Receiving Call**” displayed on the touch panel to receive a call.

- When another call comes in while talking, see “Answering a waiting call” on page 23.

To end the call or reject an incoming call, press and hold one of the above buttons.

Note

You can set the receiver to receive or reject the incoming call automatically. See “Auto Answer” on page 31.

Bluetooth Phone Operations

Calling a number in the phone book

You can call a number from the phone book in the connected cellular phone.

Before you use this function, transfer the phone book memory of the cellular phone to this unit (Refer to the instruction manual supplied with your cellular phone).

- With some cellular phones, the phone book memory is transferred automatically.

for Type A

- 1 Display the dial menu.**
- 2 Select "Phonebook."**
- 3 Select a name from the list.**
The list of phone numbers appears.
- 4 Select a phone number you want and press ENT.**

for Type B

- 1 Display the dial menu.**
- 2 Select "Phonebook."**
- 3 Select a name from the list.**
The list of phone numbers appears.
- 4 Select a phone number you want.**

for Type C

- 1 Display the dial menu.**
- 2 Select "Phonebook."**
- 3 Select a name from the list.**
The list of phone numbers appears.
- 4 Select a phone number you want and press the number button 1.**

for Type D

- 1 Display the dial menu.**
- 2 Select "PH BOOK."**
- 3 Select a name from the list.**
The list of phone numbers appears.
- 4 Select a phone number you want and press ▼.**

Calling by voice command

If your cellular phone is equipped with the voice recognition system, you can make a call by your voice.

for Type A

1 Display “Bluetooth Phone” screen.

2 Press and hold MENU.

“Say” appears on the display.

- You can also select voice dialing function from the dial menu. To use the function, select “Voice” from the dial menu.
- If your cellular phone does not support the voice recognition system, “Error” appears.

3 Speak the name you want to call.

- Pronounce slowly and clearly.

for Type B

1 Press and hold MENU.

“Say Name” appears on the display.

- You can also select voice dialing function from the dial menu. To use the function, select “Voice Dialing” from the dial menu.
- If your cellular phone does not support the voice recognition system, “Error” appears.

2 Speak the name you want to call.

- Pronounce slowly and clearly.

for Type C

1 Press and hold MODE.

“Say” appears on the display.

- You can also select voice dialing function from the dial menu. To use the function, select “Voice” from the dial menu.
- If your cellular phone does not support the voice recognition system, “Error” appears.

2 Speak the name you want to call.

- Pronounce slowly and clearly.

for Type D

1 Press and hold MODE.

“SAY” appears on the display.

- You can also select voice dialing function from the dial menu. To use the function, select “VOICE” from the dial menu.
- If your cellular phone does not support the voice recognition system, “ERROR” appears.

2 Speak the name you want to call.

- Pronounce slowly and clearly.

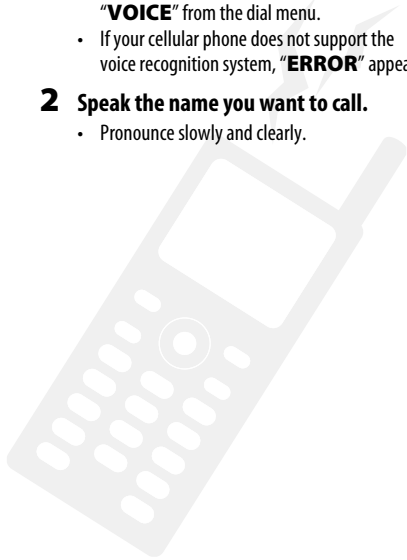

Advanced Operations

Calling a number from the call history

This unit has three kinds of call histories — redial, received calls and missed calls. You can call a number using these call histories.

for Type A

- 1 Display the dial menu.**
- 2 Select a call history.**

You can select from the following call histories;

Redial:
Calls recently made.

Received Calls:
Calls recently received.

Missed Calls:
Calls recently missed.
- 3 Select a name (if acquired) or phone number, then press ENT.**

for Type B

- 1 Display the dial menu.**
- 2 Select a call history.**

You can select from the following call histories;

Redial:
Calls recently made.

Received Calls:
Calls recently received.

Missed Calls:
Calls recently missed.
- 3 Select a name (if acquired) or phone number.**

for Type C

- 1 Display the dial menu.
- 2 Select a call history.
You can select from the following call histories;
Redial:
Calls recently made.
Received Calls:
Calls recently received.
Missed Calls:
Calls recently missed.
- 3 Select a name (if acquired) or phone number, then press number button 1.

for Type D

- 1 Display the dial menu.
- 2 Select a call history.
You can select from the following call histories;
REDIAL:
Calls recently made.
RECEIVED:
Calls recently received.
MISSED:
Calls recently missed.
- 3 Select a name (if acquired) or phone number, then press ▼.

Calling the last call number directly — Redial

This function is available only when the remote controller supplied with your receiver has the **PHONE** button.

On the remote controller only

- 1 Press and hold **PHONE**.
The last called phone number is displayed.
- 2 Press **PHONE**.

Answering a waiting call

If your cellular phone is equipped with the call waiting function, you can put the current call on hold and answer the waiting call.

Press one of the following buttons.

To restore the on-hold call, press one of the following buttons again.

- When you end one call, you can connect to the other.

Type A

Any key (except **Ⓞ** / **VATT**, **+/-**, **MAP**, **SRC** and **▲**.)

Type B/Type C/Type D

Any key (except **Ⓞ** / **VATT** and **VOL +/-**.)

for the Touch Panel model

You can also press the message “**Receiving Call**” displayed on the touch panel.



Advanced Operations

Using preset numbers

You can preset up to six phone numbers.

■ To store a preset number

for Type A

- 1** Select a phone number you want to preset from the number list (Phonebook, Redial, Received Calls or Missed Calls.)
- 2** Press and hold **ENT** to display the preset list.
- 3** Select a preset number you want to store into, then press **ENT**.

for Type B

- 1** Select a phone number you want to preset from the number list (Phonebook, Redial, Received Calls or Missed Calls.)
- 2** Press and hold **ENT** to display the preset list.
for the Touch Panel model
Press and hold a phone number on the touch panel.
- 3** Select a preset number you want to store into.

for Type C/Type D

- 1** Select a phone number you want to preset from the number list (Phonebook, Redial, Received Calls or Missed Calls.)
- 2** Press and hold a number button on the receiver you want to store the phone number into.

■ To call a preset phone number

for Type A/Type B

- 1** Press and hold **▲/▼** to display the preset list.
for the Touch Panel model
Display the preset list.
- 2** Select a preset number you want to call.

for Type C/Type D

Press a number button on the receiver you want to call.

Calling by entering a phone number

You can make a call by entering a phone number on the receiver.

for Type A

- 1 Display the dial menu.
- 2 Select "Phone Number."
- 3 Press **◀◀/▶▶/▲/▼** to enter a phone number, then select "Dial."
◀◀/▶▶/▲/▼:
Select a number.
ENT: Enter a number.

Note

You can store the entered phone number into the preset list. Select "Store" in the step 3 to display the preset list. Select a preset number you want to store into, then press **ENT**.

for Type B

- 1 Display the dial menu.
- 2 Select "Phone Number."
- 3 Enter a phone number.
Refer to the instruction manual supplied with your receiver.

Note

You can store the entered phone number into the preset list. Press and hold **ENT** or press "PRESET" on the touch panel to display the preset list.

Select a preset number you want to store into.



Advanced Operations

for Type C

- 1** Display the dial menu.
- 2** Select **"PHONE NUMBER."**
- 3** Press **|◀◀/▶▶|/▲/▼** to enter a phone number, then press the number button **1**.

|◀◀/▶▶|: Move the entry position.

▲/▼: Select a number.

5: Delete all entries.

Note

You can store the entered phone number into the preset list. Press and hold a number buttons you want to store into.

for Type D

- 1** Display the dial menu.
- 2** Select **"NUMBER."**
- 3** Press **|◀◀/▶▶|, VOLUME +/-** to enter a phone number, then press **▼**.

|◀◀/▶▶|: Move the entry position.

VOLUME +/- (Control dial):
Select a number.

Note

You can store the entered phone number into the preset list. Press and hold a number buttons you want to store into.

Receiving an SMS (Short Message Service)/ Text Message

If your cellular phone can use SMS (Short Message Service)/Text Message, you can read the messages on the display (monitor) of the receiver.

When you receive a message, "**Receiving Message/Receiving MSG/RCV MSG**" appears on the display (monitor).

for Type A/Type B

Press **ENT** or "**YES**" on the touch panel to read the message.

for Type C

Press **1** to read the message.

For Type D

"**RCV MSG**" appears on the display to tell you the arrival of the message.

- You cannot read the received message on the display.

To read the message later (only for type A/B/C)

Press **■** or **3** (for Type C) when you receive an SMS/Text Message. Received message is stored in **Unread** in message histories.

Note

You can set to ignore the arrival of the message when you receive an SMS/Text Message.
Refer to "Message Info" on page 31.

Reading an SMS/ Text Message

for Type A

1 Display "**Bluetooth Phone**" screen.

2 Select "**Mode**" ⇔ "**Message**."

3 Select a message history.

You can select one of the following message histories;

Unread:

Messages not read yet.

Read:

Messages already read.

Unsent:

Messages not sent yet.

Sent:

Messages already sent.

4 Select a message you want to read.



Advanced Operations

for Type B

1 Select “Bluetooth” ⇒ “Message Menu.”

2 Select a message history.

You can select one of the following message histories;

Unread:

Messages not read yet.

Read:

Messages already read.

Unsent:

Messages not sent yet.

Sent:

Messages already sent.

3 Select a message you want to read.

for Type C

1 Press **MODE**, then select “Message Menu.”

2 Select a message history.

You can select one of the following message histories;

Unread:

Messages not read yet.

Read:

Messages already read.

Unsent:

Messages not sent yet.

Sent:

Messages already sent.

3 Select a message you want to read.

for Type D

Not Available for this type.

Bluetooth Audio Operations

- Before you use a Bluetooth device on your receiver, connect a Bluetooth device. See “Bluetooth Connection” on page 12.
- When sound is stopped or interrupted during the use of a Bluetooth device, try the following remedies.
 - Turn Off, then turn On the power to the receiver.
 - (When sound is not yet restored,) Connect the device again. See “Connecting/Disconnecting the device” on page 17.
- For details of the menu operations, refer to the instruction manual supplied with your receiver.
- Indications on the display (monitor) and button names vary among the receivers.
ex. **SOURCE: SRC** ■: ■ / **BACK**
Bluetooth Audio: Bluetooth AUDIO, BT-AUDIO

Selecting a source

Before you operate the Bluetooth audio device, change the source to “**Bluetooth Audio.**”

for Type A

You can select “**Bluetooth Audio**” as the source.

Press **SRC** repeatedly to select “**Bluetooth Audio.**”

for Type B/Type C/Type D

You can select “**Bluetooth Audio**” as the source.

Press **SOURCE** repeatedly to select “**Bluetooth Audio.**”

Playback operations

for Type A/Type B

- ▶: Start playback
- ▶/||: Start playback/Pause
- ▶▶: Forward skip
- ◀◀: Reverse skip
- : Stop

for Type C

- 1: Start playback
- 3: Stop
- ▶▶: Forward skip
- ◀◀: Reverse skip

for Type D

- ▲: Start playback
- ▶▶: Forward skip
- ◀◀: Reverse skip

Other Settings

Basic procedure

for Type A

- 1** Display **"Bluetooth Phone"** screen or select **"Bluetooth Audio"** as the source.
- 2** Select **"Mode"** ⇨ **"Setup"** from the menu.
- 3** Select an item.
See "Setting items" on the next page.
- 4** Press the following buttons to change the settings.
▲/▼: Change the setting.
ENT: Confirm the setting.

for Type B

- 1** Display the menu, then select **"Bluetooth"** ⇨ **"Settings"**.
- 2** Select an item.
See "Setting items" on the next page.
- 3** Change the settings.
Refer to the instruction manual supplied with your receiver.

for Type C

- 1** Press **MODE**, then select **"Settings."**
- 2** Select an item.
See "Setting items" on the next page.
- 3** Press the following buttons to change the settings.
▲/▼: Change the setting.
1: Confirm the setting.

for Type D

- 1** While **"Bluetooth Phone"** or **"Bluetooth Audio"** is selected as the source, press ▼/|◀◀/▶▶| to select **"SETTINGS."**
- 2** Select an item.
See "Setting items" on the next page.
- 3** Press the following buttons to change the settings.
VOLUME +/- (Control dial):
Change the setting.
▼: Confirm the setting.

Setting items

You can change the following items in Setting menu (_: initial):

■ Auto Connect

You can set to connect a Bluetooth device automatically when the receiver is turned on.

Off: Does not connect any device automatically.

Last: Connects with the last connected device.

Order: Connects with the available registered device found at first.

■ Auto Answer

You can set the receiver to receive or reject incoming calls automatically.

Off: The receiver does not answer calls automatically.

Answer the calls manually.

On: The receiver receives incoming calls automatically.

Reject: The unit rejects all incoming calls.

■ Message Info

You can set the receiver to inform the arrival of the message when you receive an SMS (Short Message Service)/Text Message.

Auto: The receiver rings and informs you of the arrival of the message.

Manual: The receiver does not inform you of the arrival of the message.

■ Microphone Level / Mic Setting

Adjust a microphone volume.

Level: 1, 2, 3

■ Version

Display the software and hardware versions.



Troubleshooting

What appears to be trouble is not always serious. Check the following points before calling a service center.

Symptoms	Remedies
Bluetooth device does not detect the unit.	<ul style="list-style-type: none"> This unit can be connected with one Bluetooth cellular phone and one Bluetooth audio device at a time. While connecting a device, this unit cannot be detected from another device. Disconnect currently connected device and search again.
The unit does not detect the Bluetooth device.	<ul style="list-style-type: none"> Check the Bluetooth setting of the device. Search from the Bluetooth device. After detecting the unit, select "Open" on the unit to connect the device.
"Device Unfound/UNFOUND" appears on the display.	<ul style="list-style-type: none"> Check the Bluetooth setting of the device, then search again.
The unit does not make pairing with the Bluetooth device.	<ul style="list-style-type: none"> Enter the same PIN Code to the unit and target device. Select the device name from "Special Device," then connect again.
"Connection Error/ERR CNT" appears on the display.	<ul style="list-style-type: none"> Select "Connect" to connect the device again.
Echo or noise occurs.	<ul style="list-style-type: none"> Adjust the position of the microphone unit.
"Error/ERROR" appears on the display.	<ul style="list-style-type: none"> Try the function again. (If the message appears again) The connected device is not equipped with the function.
"Loading/LOADING" appears on the display.	<ul style="list-style-type: none"> Try the function again.
"Please Wait/WAIT" appears on the display.	<ul style="list-style-type: none"> Wait until the message goes off. (If the message does not go off) Turn Off, then turn On the power to the receiver.
"Reset 08/RESET 8" appears on the display.	<ul style="list-style-type: none"> Check the connection between the adapter and the unit. Turn Off, then turn On the power to the receiver.
Phone sound quality is poor.	<ul style="list-style-type: none"> Reduce the distance between the unit and the Bluetooth cellular phone. Move the car to a place where you can get a better signal reception.



Symptoms	Remedies
Sound is interrupted or skipped during playback of a Bluetooth audio device.	<ul style="list-style-type: none"> Place the Bluetooth audio device nearer to the adapter. Disconnect the connected Bluetooth cellular phone. Turn Off, then turn On the power to the receiver. (When sound is not yet restored,) connect the device again.
The connected audio device cannot be controlled.	<ul style="list-style-type: none"> Check whether the connected audio device supports AVRCP.

Bluetooth information:

If you wish to receive more information about Bluetooth, visit our JVC web site.

Specifications

GENERAL

Power Requirement:**Operating Voltage:**

DC 14.4 V (11 V to 16 V allowance)

Grounding System: Negative ground**Current consumption:** 70 mA**Allowable Operating Temperature:**

0°C to +40°C (32°F to 104°F)

Dimensions (W × H × D):

70 mm × 34.5 mm × 90 mm

(2⁻¹³/₁₆" × 1⁻³/₈" × 3⁻⁹/₁₆")

Mass (approx.):

150 g (0.32 lbs)

(excluding accessories)

BLUETOOTH SECTION

Bluetooth Version:

Bluetooth 1.2 certified

Output Power:

+4 dBm Max. (Power class 2)

Service Area:

Within 10 m (10.9 yd.)

Profile:

HSP (Headset Profile)

HFP (Hands-Free Profile)

A2DP (Advanced Audio Distribution Profile)

AVRCP (Audio/Video Remote Control Profile)

SPP (Serial Port Profile)

OPP (Object Push Profile)

Design and specifications are subject to change without notice.





JVC



EN, GE, FR, NL, SP, IT, PR, GR, TH
© 2006 Victor Company of Japan, Limited

1206MNMMDWJEIN