

PNP Epitaxial Silicon Transistor

KSA1381

Features

- High Voltage: $V_{CEO} = -300\text{ V}$
- Low Reverse Transfer Capacitance: $C_{re} = 2.3\text{ pF}$ at $V_{CB} = -30\text{ V}$
- Excellent Gain Linearity for Low THD
- High Frequency: 150 MHz
- Full Thermal and Electrical Spice Models are Available
- Complement to KSC3503
- This is a Pb-Free Device

Applications

- Audio, Voltage Amplifier and Current Source
- CRT Display, Video Output
- General Purpose Amplifier

ABSOLUTE MAXIMUM RATINGS ($T_a = 25^\circ\text{C}$ unless otherwise noted)

Symbol	Parameter	Ratings	Units
BV_{CBO}	Collector-Base Voltage	-300	V
BV_{CEO}	Collector-Emitter Voltage	-300	V
BV_{EBO}	Emitter-Base Voltage	-5	V
I_C	Collector Current (DC)	-100	mA
I_{CP}	Collector Current (Pulse)	-200	mA
P_C	Total Device Dissipation, $T_C = 25^\circ\text{C}$ $T_C = 125^\circ\text{C}$	7	W
		1.2	W
T_J, T_{STG}	Junction and Storage Temperature	-55~+150	$^\circ\text{C}$

Stresses exceeding those listed in the Maximum Ratings table may damage the device. If any of these limits are exceeded, device functionality should not be assumed, damage may occur and reliability may be affected.

THERMAL CHARACTERISTICS (Note 1)

($T_a = 25^\circ\text{C}$ unless otherwise noted)

Symbol	Parameter	Max.	Units
$R_{\theta JC}$	Thermal Resistance, Junction to Case	17.8	$^\circ\text{C/W}$

1. Device mounted on minimum pad size.

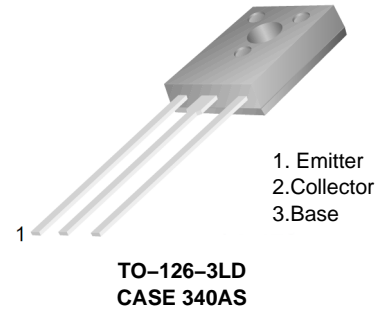

MARKING DIAGRAM

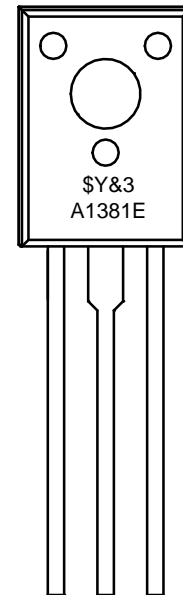

\$Y = Logo
&3 = 3-Digit Date Code
A1381E = Specific Device Code

ORDERING INFORMATION

See detailed ordering and shipping information on page 2 of this data sheet.

KSA1381

ELECTRICAL CHARACTERISTICS (Note 2) ($T_a = 25^\circ\text{C}$ unless otherwise noted)

Symbol	Characteristic	Test Condition	Min	Typ	Max	Unit
BV_{CBO}	Collector–Base Breakdown Voltage	$I_C = -10\ \mu\text{A}, I_E = 0$	-300	-	-	V
BV_{CEO}	Collector–Emitter Breakdown Voltage	$I_C = -1\ \text{mA}, I_B = 0$	-300	-	-	V
BV_{EBO}	Emitter–Base Breakdown Voltage	$I_E = -10\ \mu\text{A}, I_C = 0$	-5	-	-	V
I_{CBO}	Collector Cut–off Current	$V_{CB} = -200\ \text{V}, I_E = 0$	-	-	-0.1	μA
I_{EBO}	Emitter Cut–off Current	$V_{EB} = -4\ \text{V}, I_C = 0$	-	-	-0.1	μA
h_{FE}	DC Current Gain	$V_{CE} = -10\ \text{V}, I_C = -10\ \text{mA}$	100	-	200	
$V_{CE}(\text{sat})$	Collector–Emitter Saturation Voltage	$I_C = -20\ \text{mA}, I_B = -2\ \text{mA}$	-	-	-0.6	V
$V_{BE}(\text{sat})$	Base–Emitter Saturation Voltage	$I_C = -20\ \text{mA}, I_B = -2\ \text{mA}$	-	-	-1	V
f_T	Current Gain Bandwidth Product	$V_{CE} = -30\ \text{V}, I_C = -10\ \text{mA}$	-	150	-	MHz
C_{ob}	Output Capacitance	$V_{CB} = -30\ \text{V}, f = 1\ \text{MHz}$	-	3.1	-	pF
C_{re}	Reverse Transfer Capacitance	$V_{CB} = -30\ \text{V}, f = 1\ \text{MHz}$	-	2.3	-	pF

Product parametric performance is indicated in the Electrical Characteristics for the listed test conditions, unless otherwise noted. Product performance may not be indicated by the Electrical Characteristics if operated under different conditions.

2. Pulse Test: Pulse Width $\leq 300\ \mu\text{s}$, Duty Cycle $\leq 2\%$

ORDERING INFORMATION

Part Number (Note 3, 4)	Marking	Package	Shipping	Remarks
KSA1381ESTU	A1381E	TO-126-3LD (Pb-Free)	1920 Units / Tube	HFE1 E Grade

3. Affix “-S-” means the standard TO126 Package.(see package dimensions). If the affix is “-STS-” instead of “-S-”, that mean the short-lead TO126 package.

4. Suffix “-TU” means the tube packing, The Suffix “TU” could be replaced to other suffix character as packing method.

TYPICAL CHARACTERISTICS

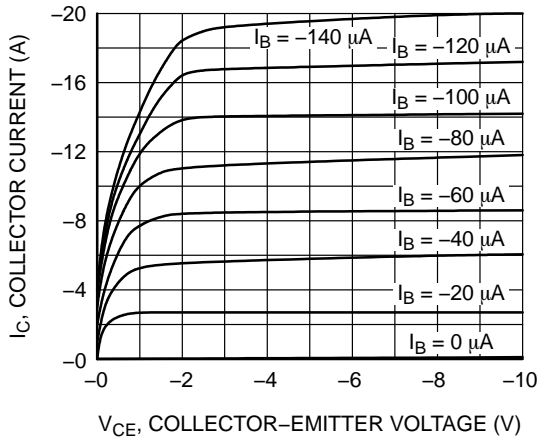

Figure 1. Static Characteristic

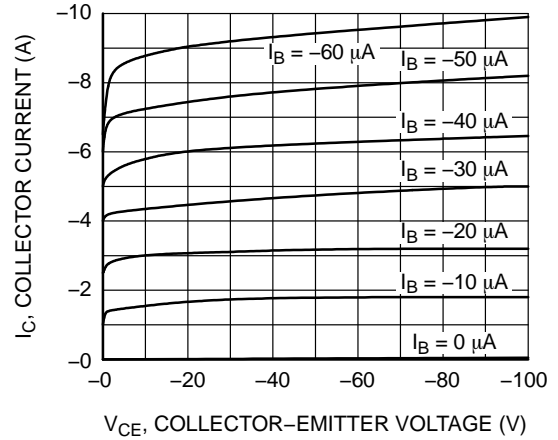

Figure 2. Static Characteristic

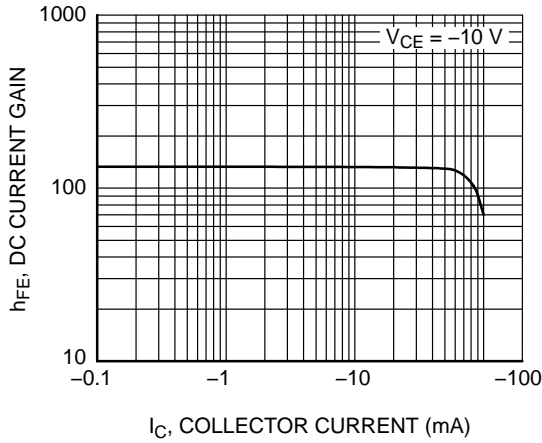

Figure 3. DC Current Gain

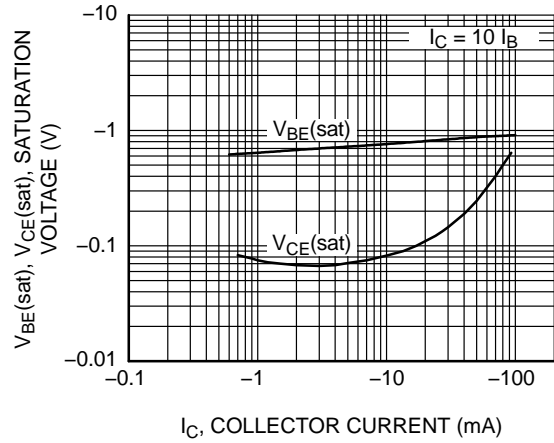

Figure 4. Base-Emitter Saturation Voltage
Collector-Emitter Saturation Voltage

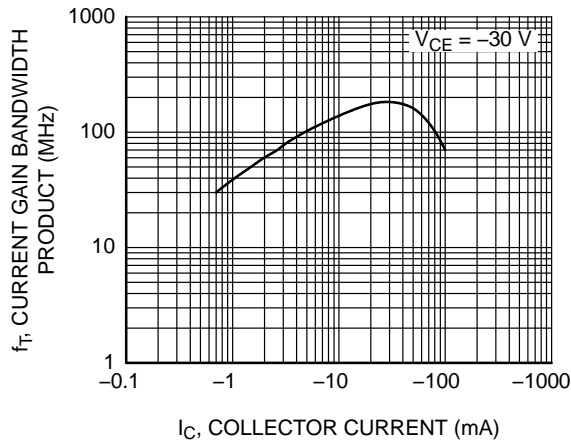

Figure 5. Current Gain Bandwidth Product

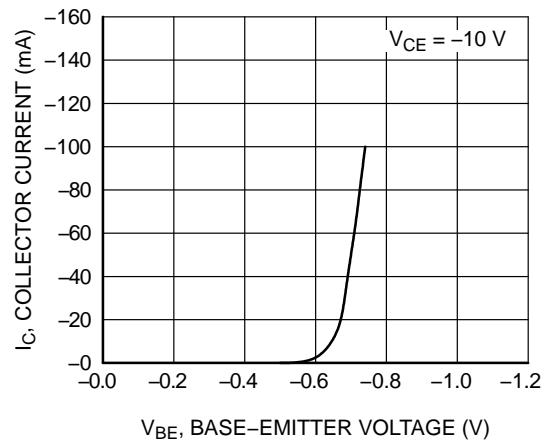

Figure 6. Base-Emitter On Voltage

TYPICAL CHARACTERISTICS (Continued)

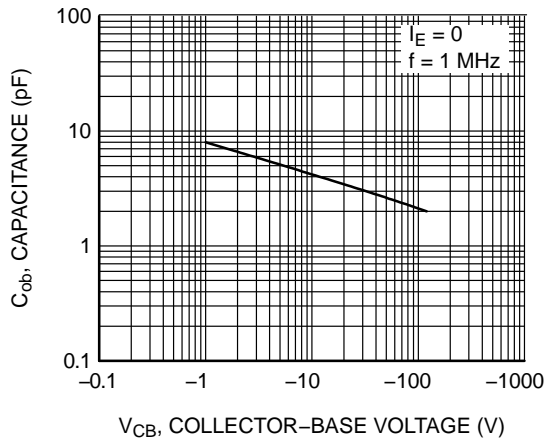

Figure 7. Collector Output Capacitance

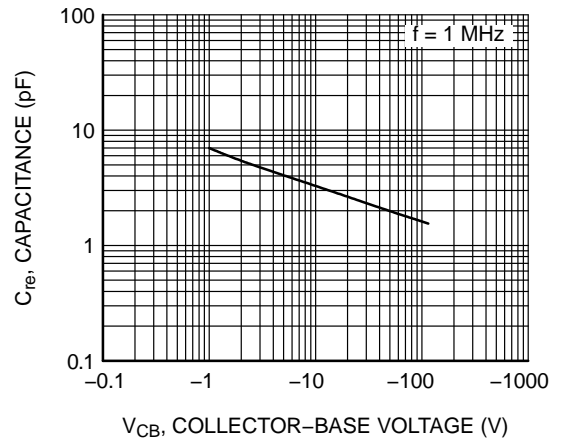

Figure 8. Reverse Transfer Capacitance

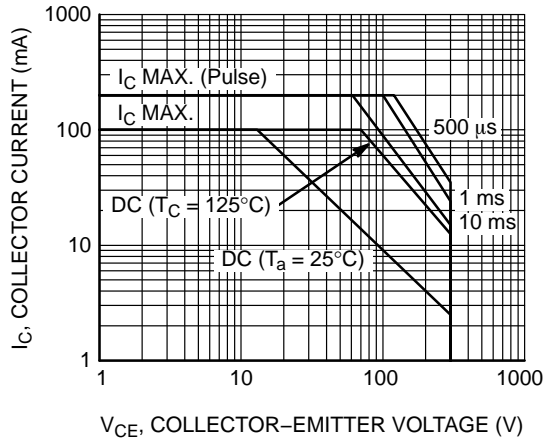

Figure 9. Safe Operating Area

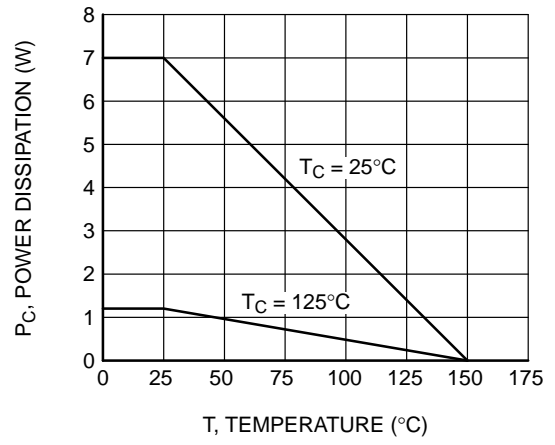
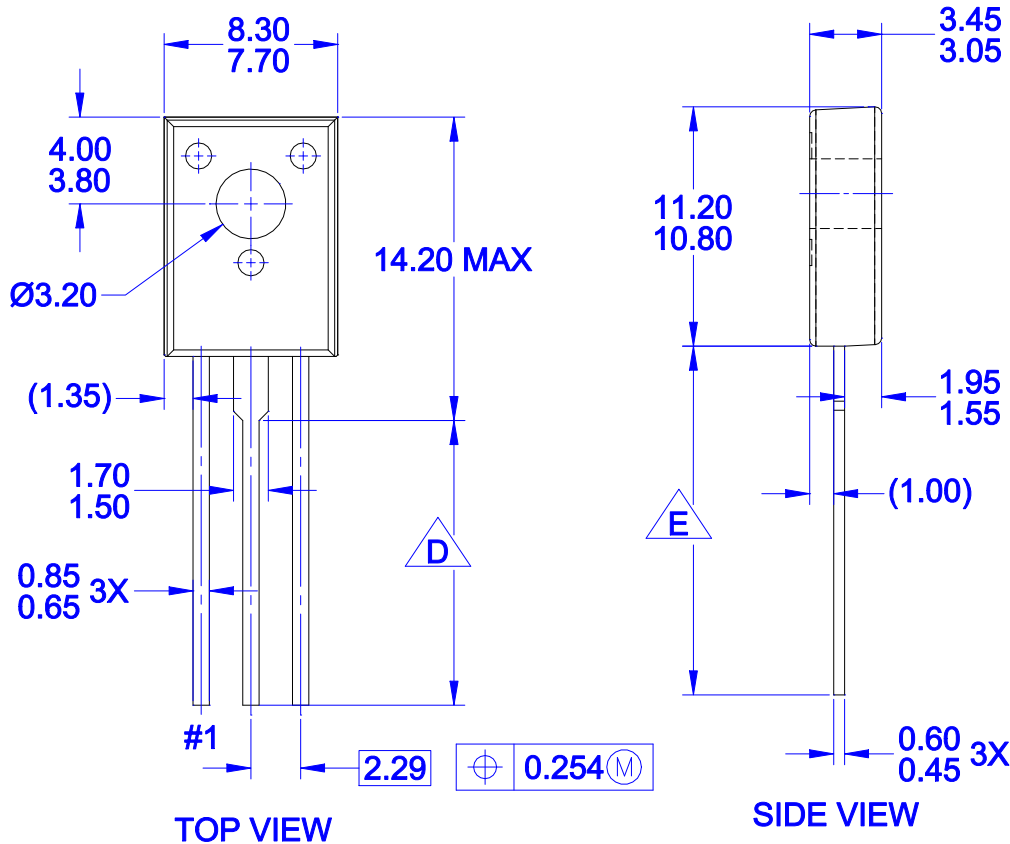

Figure 10. Power Derating

TO-126-3LD
CASE 340AS
ISSUE O

DATE 30 SEP 2016



PRODUCTION CODE	TERMINAL LENGTH "D"	TERMINAL LENGTH "E"
TSSTU	3.45 - 4.05	6.45 - 7.45
TSTU	2.36 - 2.96	5.36 - 6.36
NONE (STD LENGTH)	12.76 - 13.36	15.76 - 16.76

NOTES:

- A. NO INDUSTRY STANDARD APPLIES TO THIS PACKAGE
- B. ALL DIMENSIONS ARE IN MILLIMETERS
- C. DIMENSIONS ARE EXCLUSIVE OF BURRS, MOLD FLASH, AND TIE BAR PROTRUSIONS

- D** FOR TERMINAL LENGTH "D", REFER TO TABLE
- E** FOR TERMINAL LENGTH "E", REFER TO TABLE

DOCUMENT NUMBER: 98AON13817G	Electronic versions are uncontrolled except when accessed directly from the Document Repository. Printed versions are uncontrolled except when stamped "CONTROLLED COPY" in red.
DESCRIPTION: TO-126-3LD	PAGE 1 OF 1

onsemi and ONSEMI are trademarks of Semiconductor Components Industries, LLC dba onsemi or its subsidiaries in the United States and/or other countries. onsemi reserves the right to make changes without further notice to any products herein. onsemi makes no warranty, representation or guarantee regarding the suitability of its products for any particular purpose, nor does onsemi assume any liability arising out of the application or use of any product or circuit, and specifically disclaims any and all liability, including without limitation special, consequential or incidental damages. onsemi does not convey any license under its patent rights nor the rights of others.

onsemi, **Onsemi**, and other names, marks, and brands are registered and/or common law trademarks of Semiconductor Components Industries, LLC dba "**onsemi**" or its affiliates and/or subsidiaries in the United States and/or other countries. **onsemi** owns the rights to a number of patents, trademarks, copyrights, trade secrets, and other intellectual property. A listing of **onsemi**'s product/patent coverage may be accessed at www.onsemi.com/site/pdf/Patent-Marking.pdf. **onsemi** reserves the right to make changes at any time to any products or information herein, without notice. The information herein is provided "as-is" and **onsemi** makes no warranty, representation or guarantee regarding the accuracy of the information, product features, availability, functionality, or suitability of its products for any particular purpose, nor does **onsemi** assume any liability arising out of the application or use of any product or circuit, and specifically disclaims any and all liability, including without limitation special, consequential or incidental damages. Buyer is responsible for its products and applications using **onsemi** products, including compliance with all laws, regulations and safety requirements or standards, regardless of any support or applications information provided by **onsemi**. "Typical" parameters which may be provided in **onsemi** data sheets and/or specifications can and do vary in different applications and actual performance may vary over time. All operating parameters, including "Typicals" must be validated for each customer application by customer's technical experts. **onsemi** does not convey any license under any of its intellectual property rights nor the rights of others. **onsemi** products are not designed, intended, or authorized for use as a critical component in life support systems or any FDA Class 3 medical devices or medical devices with a same or similar classification in a foreign jurisdiction or any devices intended for implantation in the human body. Should Buyer purchase or use **onsemi** products for any such unintended or unauthorized application, Buyer shall indemnify and hold **onsemi** and its officers, employees, subsidiaries, affiliates, and distributors harmless against all claims, costs, damages, and expenses, and reasonable attorney fees arising out of, directly or indirectly, any claim of personal injury or death associated with such unintended or unauthorized use, even if such claim alleges that **onsemi** was negligent regarding the design or manufacture of the part. **onsemi** is an Equal Opportunity/Affirmative Action Employer. This literature is subject to all applicable copyright laws and is not for resale in any manner.

ADDITIONAL INFORMATION

TECHNICAL PUBLICATIONS:

Technical Library: www.onsemi.com/design/resources/technical-documentation
onsemi Website: www.onsemi.com

ONLINE SUPPORT: www.onsemi.com/support

For additional information, please contact your local Sales Representative at www.onsemi.com/support/sales