

Silicon PNP Power Transistors

KSA614

DESCRIPTION

www.datasheet4u.com

- With TO-220 package
- Collector-Base Voltage: $V_{CBO}=-80V(\text{Min})$
- Collector dissipation: $P_C=25W@T_C=25^\circ$

APPLICATIONS

- Low frequency power amplifier
- Power regulator

PINNING

PIN	DESCRIPTION
1	Emitter
2	Collector;connected to mounting base
3	Base

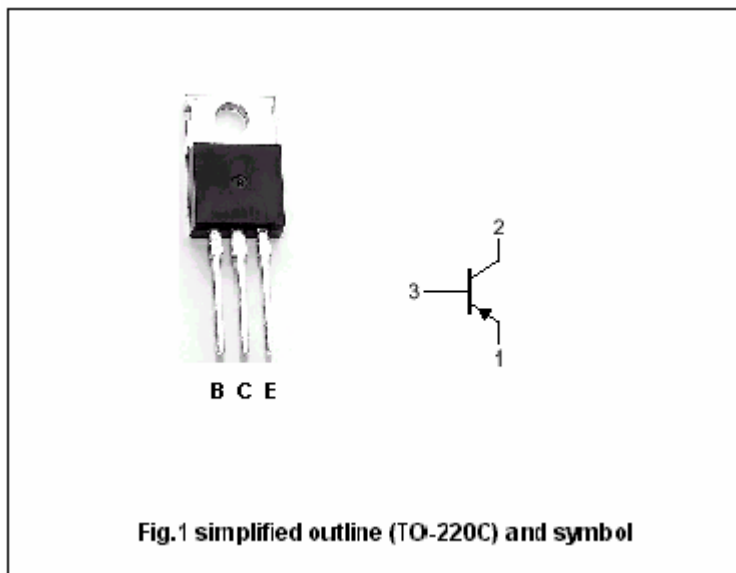

Absolute maximum ratings ( $T_a=25^\circ$ )

SYMBOL	PARAMETER	CONDITIONS	VALUE	UNIT
$V_{CBO}$	Collector-base voltage	Open emitter	-80	V
$V_{CEO}$	Collector-emitter voltage	Open base	-55	V
$V_{EBO}$	Emitter-base voltage	Open collector	-5	V
$I_C$	Collector current (DC)		-3	A
$P_C$	Collector power dissipation	$T_C=25^\circ$	25	W
$T_j$	Junction temperature		150	$^\circ$
$T_{stg}$	Storage temperature		-55~150	$^\circ$

## Silicon PNP Power Transistors

## KSA614

## CHARACTERISTICS

T<sub>j</sub>=25 °C unless otherwise specified

www.datasheet4u.com

SYMBOL	PARAMETER	CONDITIONS	MIN	TYP.	MAX	UNIT
V <sub>(BR)CEO</sub>	Collector-emitter breakdown voltage	I <sub>C</sub> =-10mA ; I <sub>B</sub> =0	-80			V
V <sub>(BR)CBO</sub>	Collector-base breakdown voltage	I <sub>C</sub> =-0.5mA ; I <sub>E</sub> =0	-55			V
V <sub>(BR)EBO</sub>	Emitter-base breakdown voltage	I <sub>E</sub> =-0.5mA ; I <sub>C</sub> =0	-5			V
V <sub>CEsat</sub>	Collector-emitter saturation voltage	I <sub>C</sub> =-1A ; I <sub>B</sub> =-0.1A			-0.5	V
I <sub>CBO</sub>	Collector cut-off current	V <sub>CB</sub> =-50V ; I <sub>E</sub> =0			-50	μA
I <sub>EBO</sub>	Emitter cut-off current	V <sub>EB</sub> =-5V ; I <sub>C</sub> =0			-50	μA
h <sub>FE</sub>	DC current gain	I <sub>C</sub> =-0.5A ; V <sub>CE</sub> =-5V	40		240	

◆ h<sub>FE</sub> classifications

R	O	Y
40-80	70-140	120-240

Silicon PNP Power Transistors

KSA614

PACKAGE OUTLINE

www.datasheet4u.com

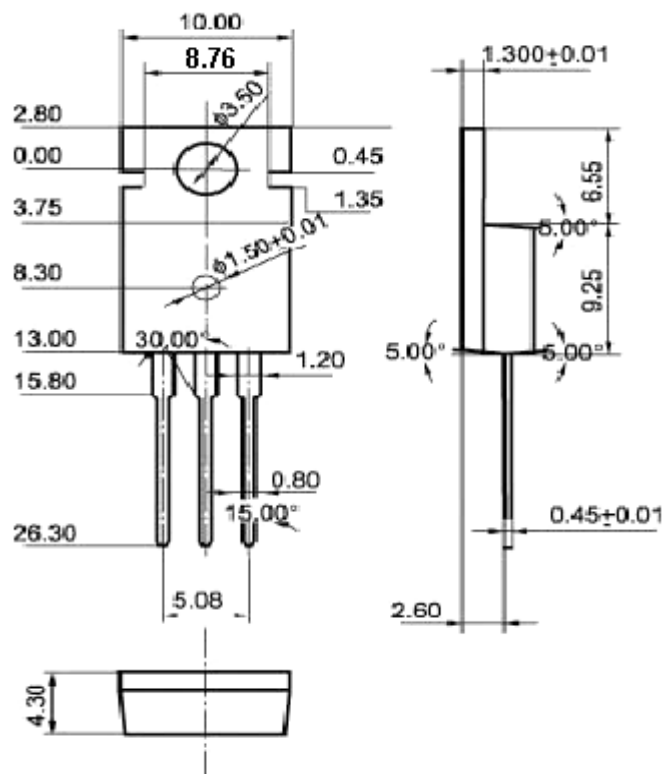

Fig.2 outline dimensions (unindicated tolerance: ±0.10 mm)

Silicon PNP Power Transistors

KSA614

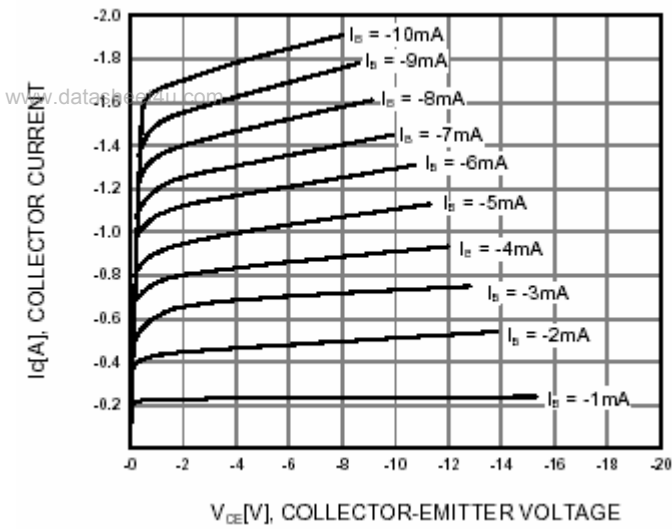

Fig.3 Static Characteristic

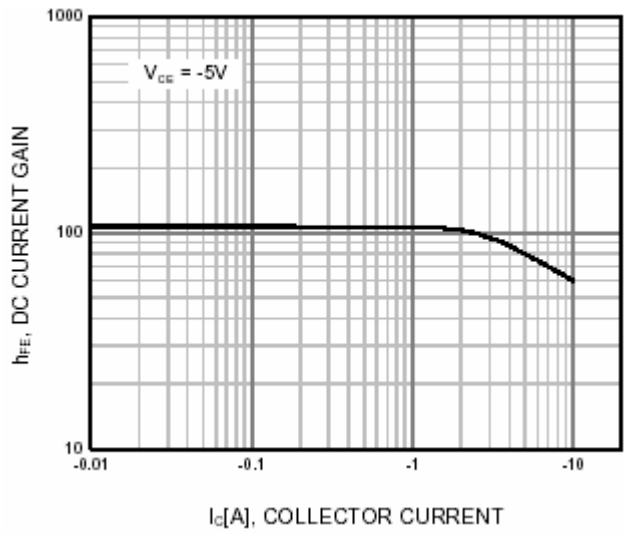

Fig.4 DC current Gain

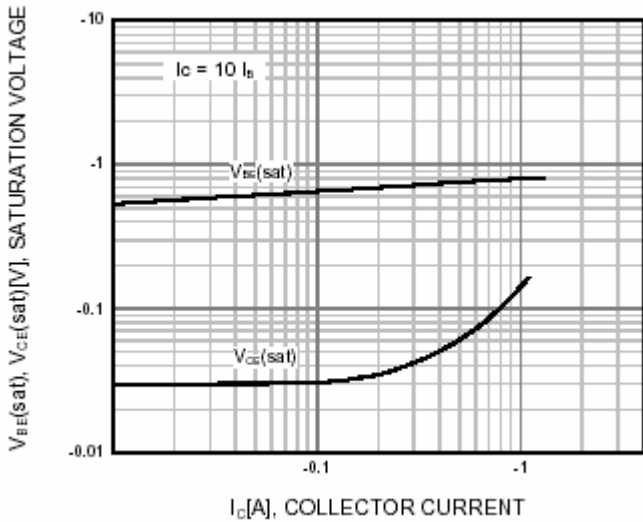

Fig.5 Base-Emitter Saturation Voltage  
Collector-Emitter Saturation Voltage

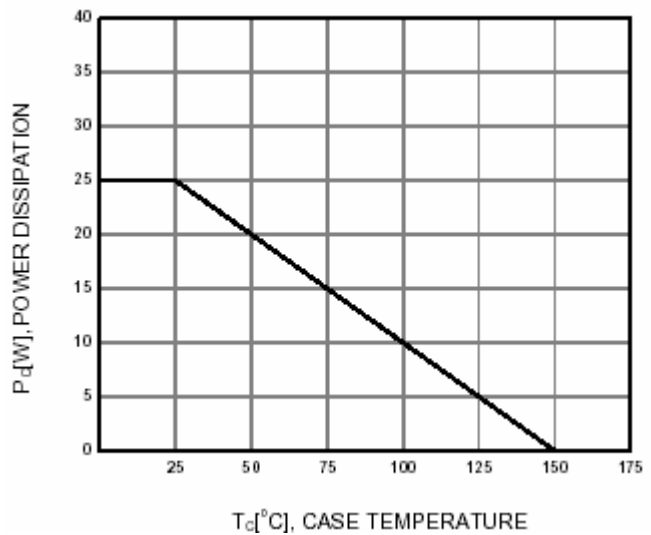

Fig.6 Power Derating

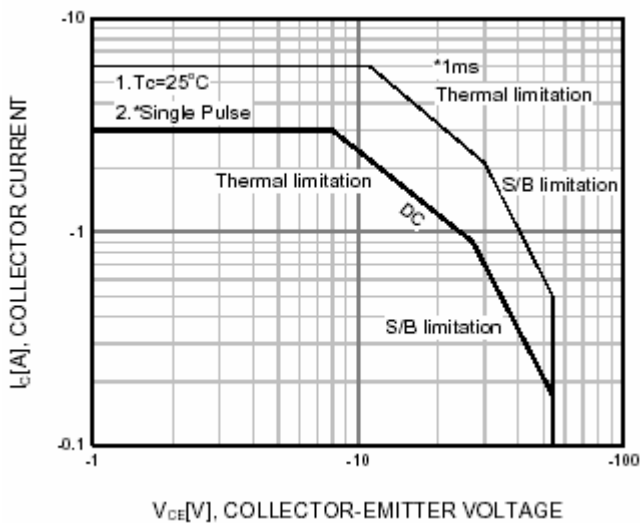

Fig.7 Safe Operating Area