

KSC1098**NPN EPITAXIAL SILICON TRANSISTOR**

T-33-07

LOW FREQUENCY AMPLIFIER

- Complement to KSA836
- Collector-Base Voltage $V_{CBO} = 70V$
- Collector Current $I_C = 2A$
- Collector Dissipation $P_C = 10W$ ($T_C = 25^\circ C$)

ABSOLUTE MAXIMUM RATINGS ($T_a = 25^\circ C$)

Characteristic	Symbol	Rating	Unit
Collector-Base Voltage	V_{CBO}	70	V
Collector-Emitter Voltage	V_{CEO}	45	V
Emitter-Base Voltage	V_{EBO}	5	V
Collector Current	I_C	2.0	A
Collector Dissipation ($T_C = 25^\circ C$)	P_C	10	W
Junction Temperature	T_j	+150	$^\circ C$
Storage Temperature	T_{stg}	-55~+150	$^\circ C$

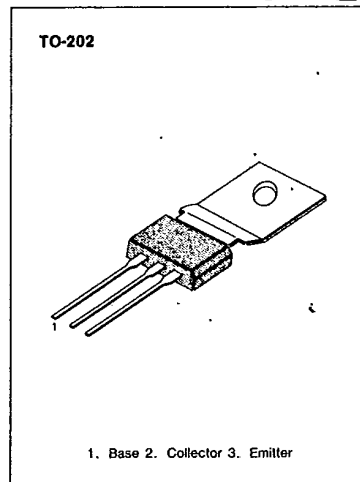
**ELECTRICAL CHARACTERISTICS ($T_a = 25^\circ C$)**

Characteristic	Symbol	Test Conditions	Min	Typ	Max	Unit
Collector-Base Breakdown Voltage	BV_{CBO}	$I_C = 500\mu A, I_E = 0$	70			V
Collector-Emitter Breakdown Voltage	BV_{CEO}	$I_C = 10mA, R_{BE} = \infty$	45			V
Emitter-Base Breakdown Voltage	BV_{EBO}	$I_E = 500\mu A, I_C = 0$	5			V
Collector Cut-off Current	I_{CBO}	$V_{CB} = 40V, I_E = 0$			100	μA
DC Current Gain	h_{FE}	$V_{CE} = 5V, I_C = 0.5A$	40		240	
Collector-Emitter Saturation Voltage	$V_{CE(sat)}$	$I_C = 1A, I_B = 0.1A$			1.0	V

 h_{FE} CLASSIFICATION

Classification	R	O	Y
h_{FE}	40-80	70-140	120-240



KSC1098

NPN EPITAXIAL SILICON TRANSISTOR

T-33-07

STATIC CHARACTERISTIC

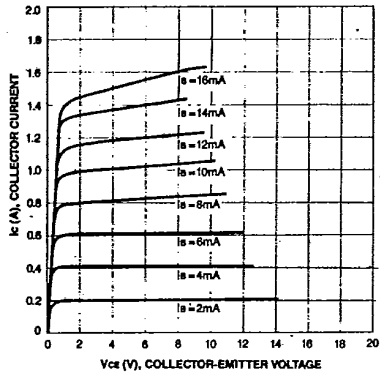

DC CURRENT GAIN

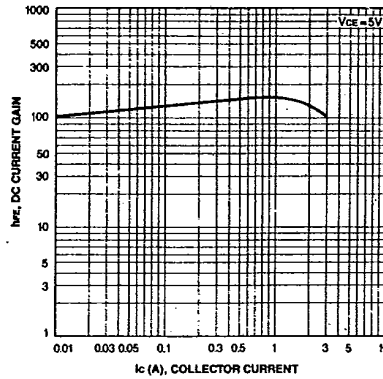

BASE-EMITTER SATURATION VOLTAGE
COLLECTOR-EMITTER SATURATION VOLTAGE

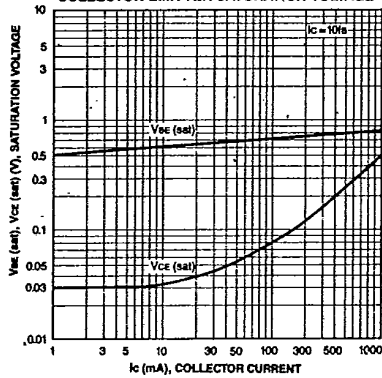

COLLECTOR OUTPUT CAPACITANCE

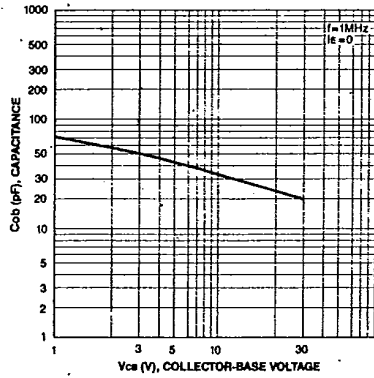

SAFE OPERATING AREA

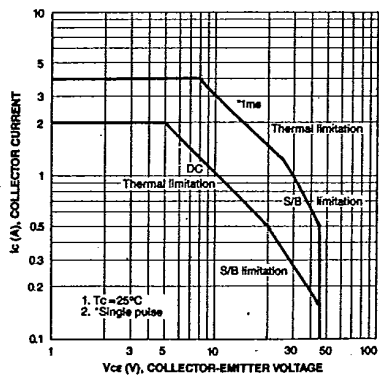

POWER DERATING

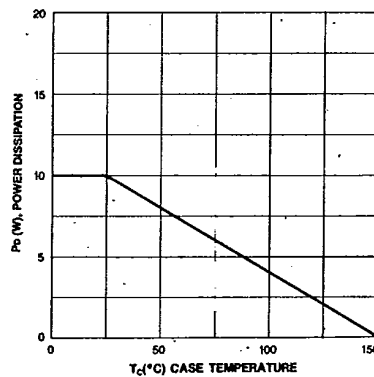

3



KSC1173

NPN EPITAXIAL SILICON TRANSISTOR

T-33-07

LOW FREQUENCY POWER AMPLIFIER
POWER REGULATOR

- * Complement to KSA473
- * Collector Current: $I_C = 3A$
- * Collector Dissipation: $P_C = 10W$ ($T_C = 25^\circ C$)

ABSOLUTE MAXIMUM RATINGS ($T_a = 25^\circ C$)

Characteristic	Symbol	Rating	Unit
Collector-Base Voltage	BV_{CBO}	30	V
Collector-Emitter Voltage	BV_{CEO}	30	V
Emitter-Base Voltage	BV_{EBO}	5	V
Collector Current	I_C	3	A
Collector Dissipation ($T_C = 25^\circ C$)	P_C	10	W
Junction Temperature	T_j	150	$^\circ C$
Storage Temperature	T_{stg}	-55 ~ +150	$^\circ C$

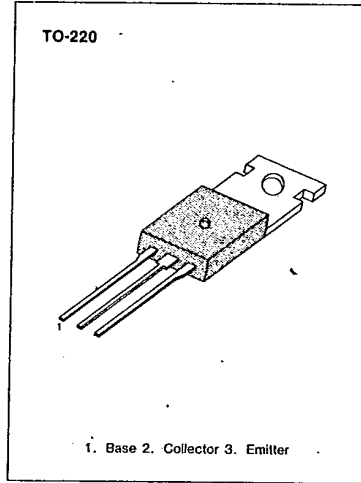
ELECTRICAL CHARACTERISTICS ($T_a = 25^\circ C$)

Characteristic	Symbol	Test Conditions	Min	Typ	Max	Unit
Collector-Base Breakdown Voltage	BV_{CBO}	$I_C = 500\mu A, I_E = 0$	30			V
Collector-Emitter Breakdown Voltage	BV_{CEO}	$I_C = 10mA, I_B = 0$	30			V
Emitter-Base Breakdown Voltage	BV_{EBO}	$I_E = -1mA, I_C = 0$	5			V
Collector Cut-off Current	I_{CBO}	$V_{CB} = 20V, I_E = 0$			1.0	μA
Emitter Cut-off Current	I_{EBO}	$V_{EB} = 5V, I_C = 0$			1.0	μA
DC Current Gain	h_{FE1}	$V_{CE} = 2V, I_C = 0.5A$	70		240	
	h_{FE2}	$V_{CE} = 2V, I_C = 2.5A$	25			
Collector-Emitter Saturation Voltage	$V_{CE(sat)}$	$I_C = 2A, I_B = 0.2A$		0.3	0.8	V
Base-Emitter On Voltage	$V_{BE(on)}$	$V_{CE} = 2V, I_C = 0.5A$		0.75	1.0	V
Current Gain Base Width Product	f_T	$V_{CE} = 2V, I_C = 0.5A$		100		MHz
Output Capacitance	C_{ob}	$V_{CB} = 10V, I_E = 0, f = 1MHz$		35		PF

 h_{FE} CLASSIFICATION

Classification	O	Y
$h_{FE}(1)$	70-140	120-240

KSC1173

NPN EPITAXIAL SILICON TRANSISTOR

T-33-07

STATIC CHARACTERISTIC

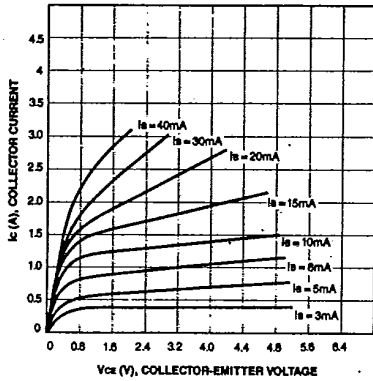

DC CURRENT GAIN

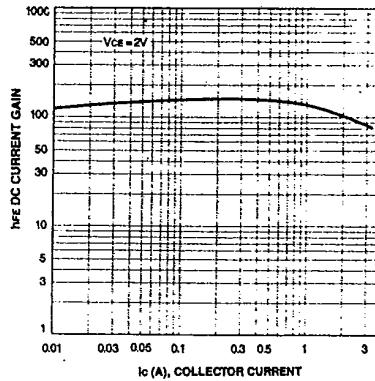

BASE-EMITTER ON VOLTAGE

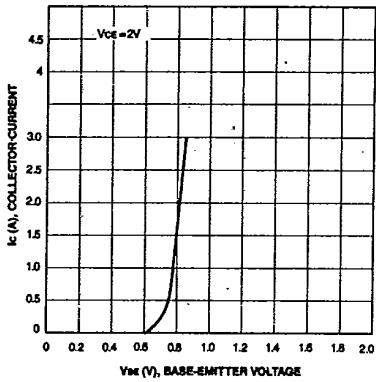

BASE-EMITTER SATURATION VOLTAGE
COLLECTOR-EMITTER SATURATION VOLTAGE

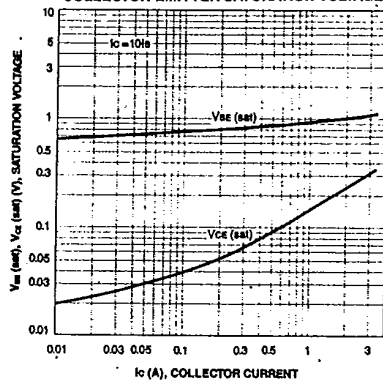

3

SAFE OPERATING AREA

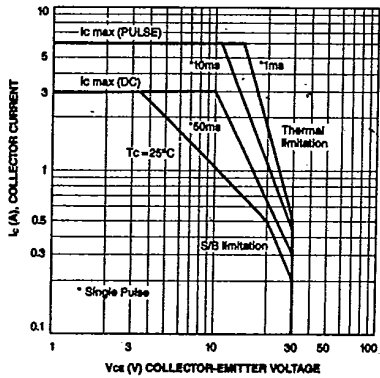

POWER DERATING

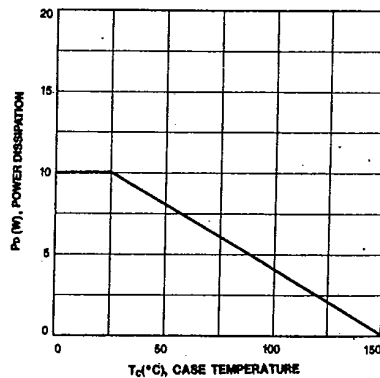

KSC1173

NPN EPITAXIAL SILICON TRANSISTOR

T-33-07

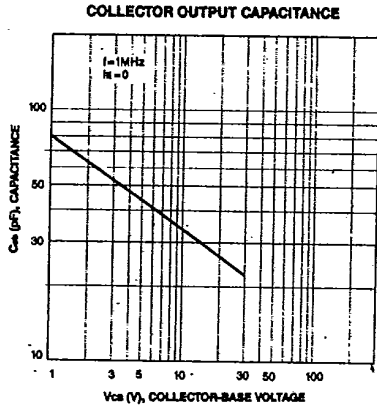

KSC1507**NPN EPITAXIAL SILICON TRANSISTOR**

T-33-07

COLOR TV CHROMA OUTPUT

- High Collector-Emitter Voltage $V_{CE0} = 300V$
- Current-Gain-Bandwidth Product $f_T = 40MHz$ (Min)

ABSOLUTE MAXIMUM RATINGS ($T_a = 25^\circ C$)

Characteristic	Symbol	Rating	Unit
Collector-Base Voltage	V_{CB0}	300	V
Collector-Emitter Voltage	V_{CE0}	300	V
Emitter-Base Voltage	V_{EB0}	7	V
Collector Current	I_C	200	mA
Collector Dissipation ($T_C = 25^\circ C$)	P_C	15	W
Junction Temperature	T_j	150	$^\circ C$
Storage Temperature	T_{stg}	-55 ~ +150	$^\circ C$

TO-220

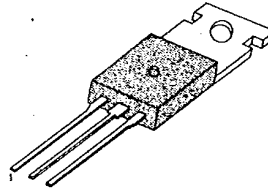

1. Base 2. Collector 3. Emitter

3

ELECTRICAL CHARACTERISTICS ($T_a = 25^\circ C$)

Characteristic	Symbol	Test Conditions	Min	Typ	Max	Unit
Collector-Base Breakdown Voltage	BV_{CB0}	$I_C = 100\mu A, I_E = 0$	300			V
Collector-Emitter Breakdown Voltage	BV_{CE0}	$I_C = 10mA, I_B = 0$	300			V
Emitter-Base Breakdown Voltage	BV_{EB0}	$I_E = -10\mu A, I_C = 0$	7			V
Collector Cut-off Current	I_{CBO}	$V_{CB} = 200V, I_E = 0$			100	μA
DC Current Gain	h_{FE}	$V_{CE} = 10V, I_C = 10mA$	40		240	
Collector-Emitter Saturation Voltage	$V_{CE(sat)}$	$I_C = 50mA, I_B = 5mA$			2.0	V
Current Gain-Bandwidth Product	f_T	$V_{CE} = 30V, I_C = 10mA$	40	80		MHz
Output Capacitance	C_{ob}	$V_{CB} = 50V, I_E = 0$ $f = 1MHz$		4		pF

 h_{FE} CLASSIFICATION

Classification	R	O	Y	G
h_{FE}	40-80	70-140	120-240	200-400

KSC1507

NPN EPITAXIAL SILICON TRANSISTOR

T-33-07

STATIC CHARACTERISTIC

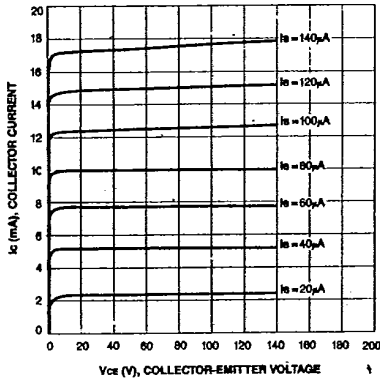

DC CURRENT GAIN

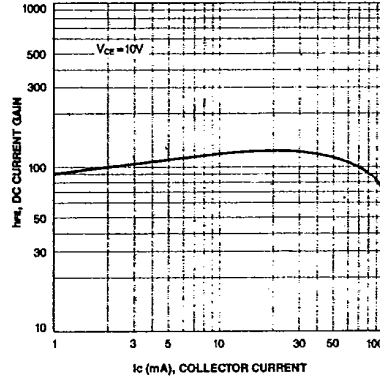

BASE-EMITTER SATURATION VOLTAGE
COLLECTOR-EMITTER SATURATION VOLTAGE

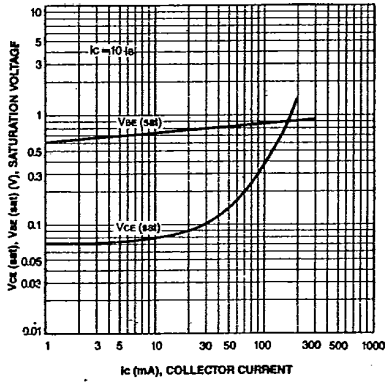

COLLECTOR OUTPUT CAPACITANCE

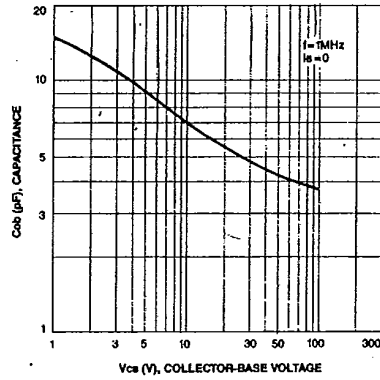

POWER DERATING

