

### ● Description

The KT101X series consist of an infrared emitting diode, optically coupled to a phototransistor detector, and is incorporated in a 4 pin LSOP wide body package. It features a high current transfer ratio, low coupling capacitance and high isolation voltage.

### ● Schematic

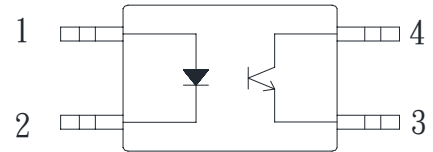

1. Anode
2. Cathode
3. Emitter
4. Collector

### ● Features

1. Pb free and RoHS compliant
2. Temperature range -55°C to 115°C
3. High isolation voltage 5000Vrms
4. Opaque type, SMD low profile 4 lead package
5. Current transfer ratio  
(CTR : Min.50% at  $I_F=5\text{mA}$   $V_{CE}=5\text{V}$ )
6. 8mm outer creepage distance
7. DC input with transistor output
8. MSL class 1
9. Agency Approvals:
  - UL Approved (No. E169586): UL1577
  - c-UL Approved (No. E169586)
  - VDE Approved (No. 40031267): DIN EN60747-5-5
  - FIMKO Approved: EN60065, EN60950, EN60335, EN60601
  - SEMKO Approved: EN60335, EN60065, EN60950
  - CQC Approved: GB8898-2011, GB4943.1-2011

### ● Applications

- Hybrid substrates that require high density mounting
- Programmable controllers
- Switch mode power supplies
- Microprocessor system interface

● **Outside Dimension**

Unit : mm

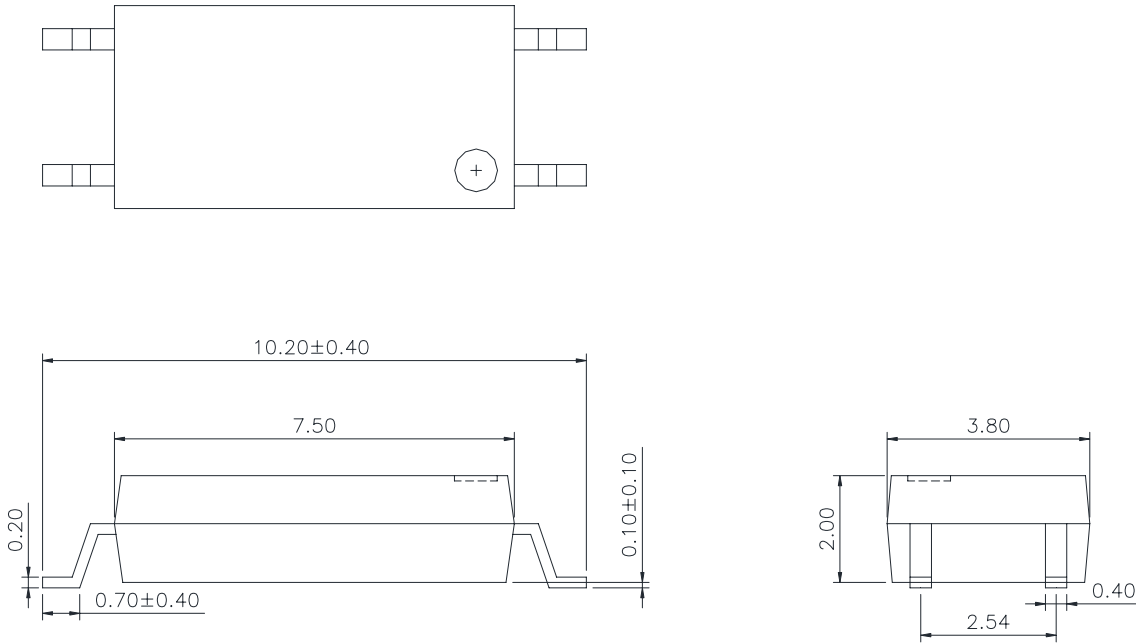

TOLERANCE :  $\pm 0.2\text{mm}$

● **Device Marking**

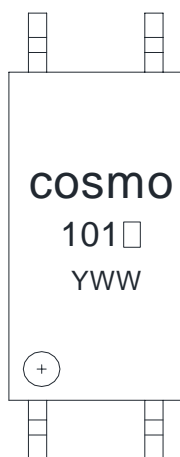

**Notes:**

cosmo

101 □

YWW

□ : CTR rank

Y: Year code / WW: Week code

● **Absolute Maximum Ratings**

(Ta=25°C)

Parameter		Symbol	Rating	Unit
Input	Forward current	$I_F$	50	mA
	Peak forward current	$I_{FP}$	1	A
	Reverse voltage	$V_R$	6	V
	Power dissipation	$P_D$	100	mW
Output	Collector-Emitter voltage	$V_{CEO}$	80	V
	Emitter-Collector voltage	$V_{ECO}$	7	V
	Collector current	$I_C$	50	mA
	Collector power dissipation	$P_C$	150	mW
Total power dissipation		$P_{tot}$	250	mW
Isolation voltage 1 minute		$V_{iso}$	5000	Vrms
Operating temperature		$T_{opr}$	-55 to +115	°C
Storage temperature		$T_{stg}$	-55 to +125	°C
Soldering temperature 10 seconds		$T_{sol}$	260	°C

● **Electro-optical Characteristics**

(Ta=25°C)

Parameter		Symbol	Conditions	Min.	Typ.	Max.	Unit
Input	Forward voltage	$V_F$	$I_F=20mA$	-	1.2	1.4	V
	Reverse current	$I_R$	$V_R=4V$	-	-	10	uA
	Terminal capacitance	$C_t$	$V=0, f=1KHz$	-	30	250	pF
Output	Collector dark current	$I_{CEO}$	$V_{CE}=20V, I_F=0$	-	-	0.1	uA
	Collector-Emitter breakdown voltage	$BV_{CEO}$	$I_C=0.1mA, I_F=0$	80	-	-	V
	Emitter-Collector breakdown voltage	$BV_{ECO}$	$I_E=100uA, I_F=0$	7	-	-	V
Transfer characteristics	Current transfer ratio	CTR	$I_F=5mA, V_{CE}=5V$	50	-	600	%
			$I_F=1mA, V_{CE}=5V$	15	-	-	%
	Collector-emitter saturation voltage	$V_{CE(sat)}$	$I_F=10mA, I_C=1mA$	-	0.1	0.3	V
	Isolation resistance	$R_{iso}$	DC500V, 40 to 60%RH	$5 \times 10^{10}$	$10^{11}$	-	$\Omega$
	Floating capacitance	$C_f$	$V=0, f=1MHz$	-	0.6	1.0	pF
	Response time (Rise)	$t_r$	$V_{CC}=2V, I_C=2mA, R_L=100\Omega$	-	5	-	us
	Response time (Fall)	$t_f$		-	4	-	us

Classification table of current transfer ratio is shown below.

CTR Rank	CTR (%)
KT1015	50 TO 150
KT1016	100 TO 300
KT1017	80 TO 160
KT1018	130 TO 260
KT1019	200 TO 400
KT1010	50 TO 600

**Fig.1 Current Transfer Ratio vs. Forward Current**

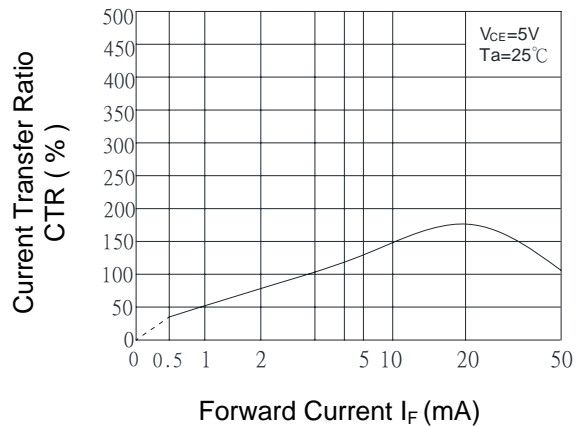

**Fig.2 Collector Power Dissipation vs. Ambient Temperature**

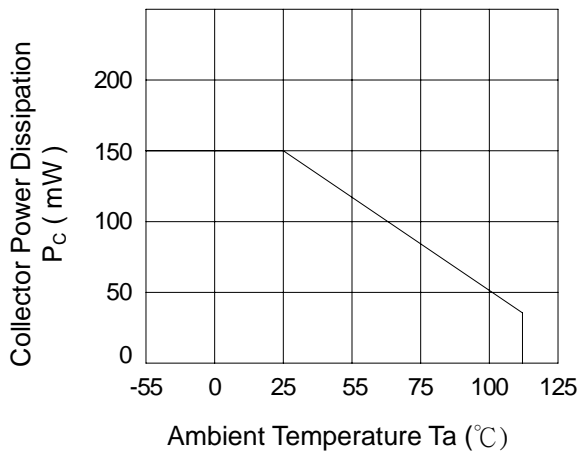

**Fig.3 Collector Dark Current vs. Ambient Temperature**

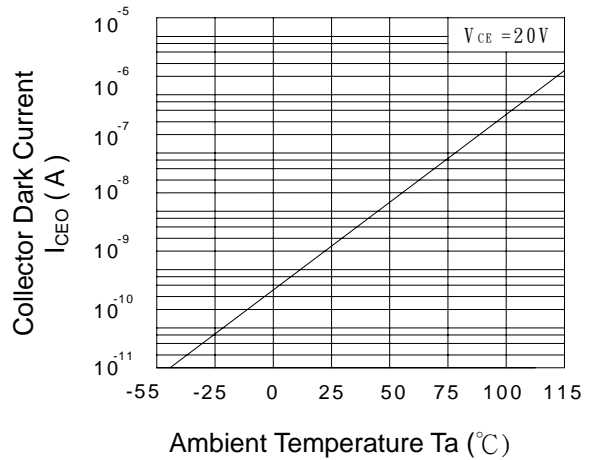

**Fig.4 Forward Current vs. Ambient Temperature**

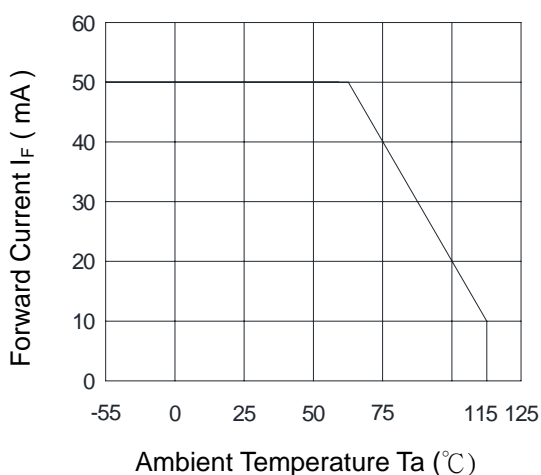

**Fig.5 Forward Current vs. Forward Voltage**

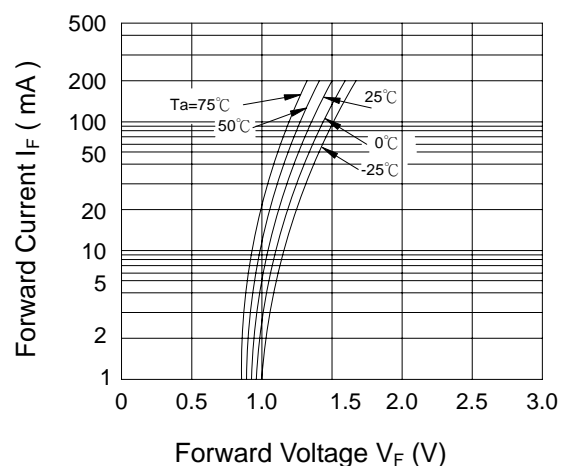

**Fig.6 Collector Current vs. Collector-Emitter Voltage**

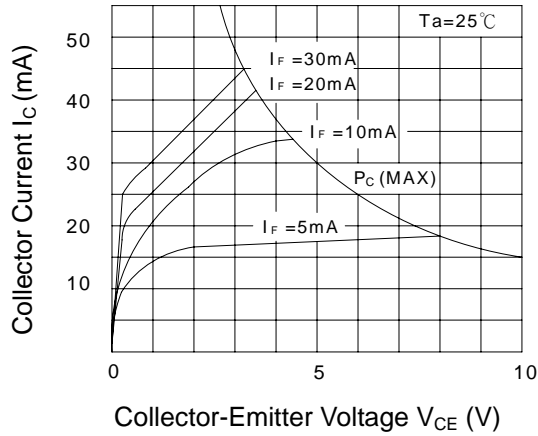

**Fig.7 Relative Current Transfer Ratio vs. Ambient Temperature**

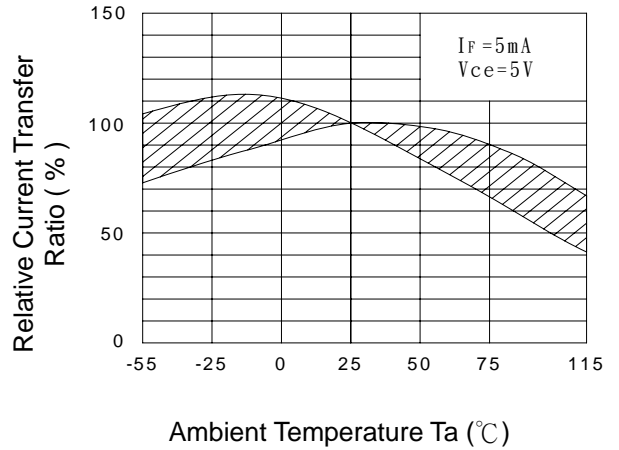

**Fig.8 Collector-Emitter Saturation Voltage vs. Ambient Temperature**

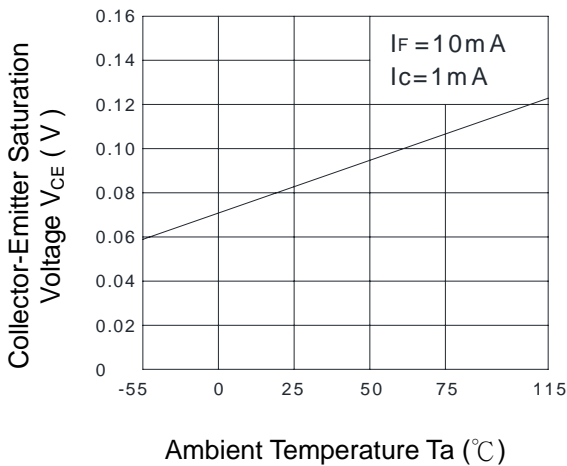

**Fig.9 Collector-Emitter Saturation Voltage vs. Forward Current**

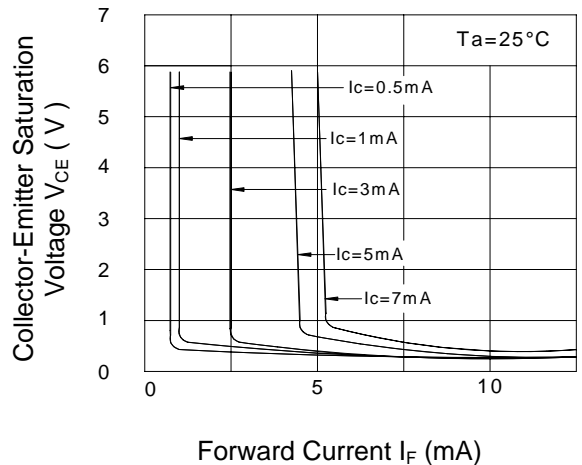

**Fig.10 Response Time (Rise) vs. Load Resistance**

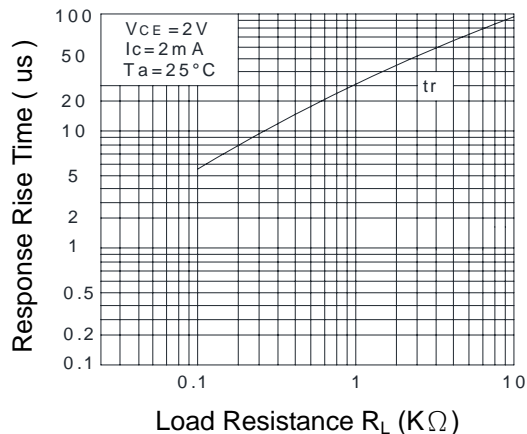

**Fig.11 Response Time (Fall) vs. Load Resistance**

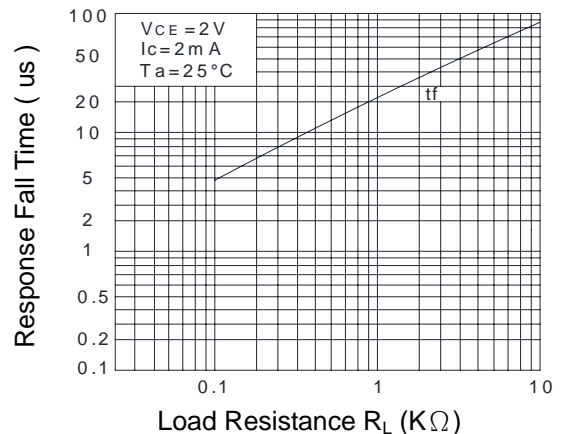

● **Test Circuit for Response Time**

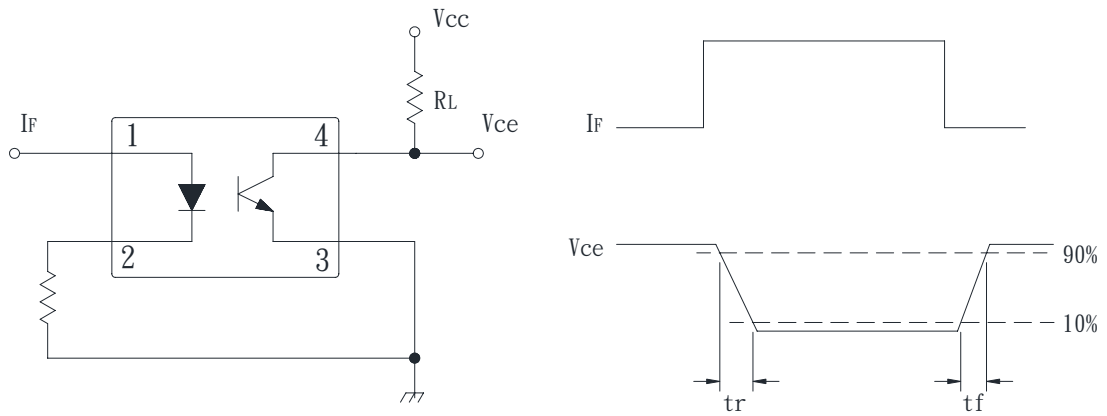

### ● Recommended Soldering Conditions

#### (a) Infrared reflow soldering :

- Peak reflow soldering : 260°C or below (package surface temperature)
- Time of peak reflow temperature : 10 sec
- Time of temperature higher than 230°C : 30-60 sec
- Time to preheat temperature from 180~190°C : 60-120 sec
- Time(s) of reflow : Two
- Flux : Rosin flux containing small amount of chlorine (The flux with a maximum chlorine content of 0.2 Wt% is recommended.)

#### Recommended Temperature Profile of Infrared Reflow

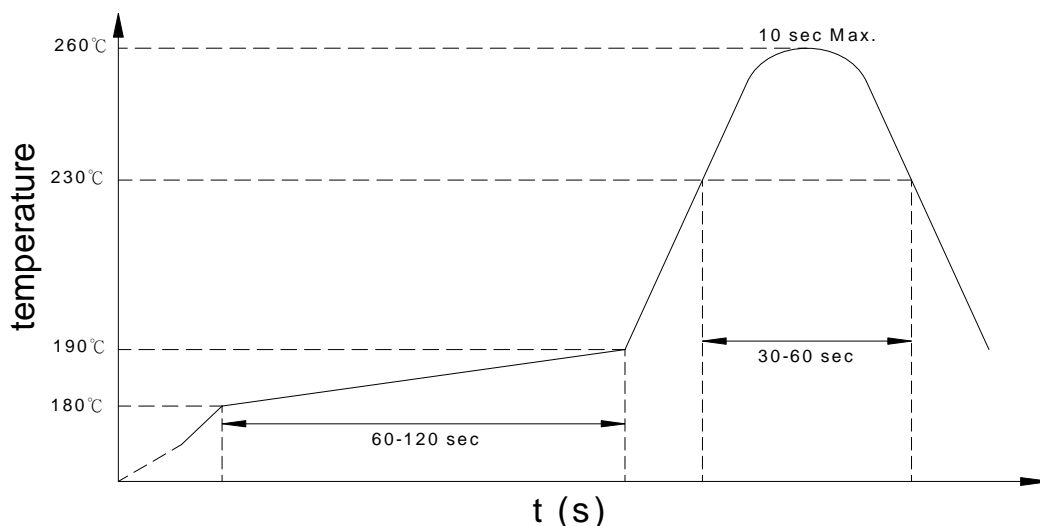

#### (b) Wave soldering :

- Temperature : 260°C or below (molten solder temperature)
- Time : 10 seconds or less
- Preheating conditions : 120°C or below (package surface temperature)
- Time(s) of reflow : One
- Flux : Rosin flux containing small amount of chlorine (The flux with a maximum chlorine content of 0.2 Wt% is recommended.)

#### (c) Cautions :

- Fluxes : Avoid removing the residual flux with freon-based and chlorine-based cleaning solvent.
- Avoid shorting between portion of frame and leads.

- **Numbering System**

## KT101 Y (Z)

**Notes:**

KT101 = Part No.

Y = CTR rank option (5 ~ 10)

Z = Tape and reel option (TLD · TRU)

Option	Description	Packing quantity
TLD	TLD tape & reel option	3000 units per reel
TRU	TRU tape & reel option	3000 units per reel

- **Recommended Pad Layout for Surface Mount Lead Form**

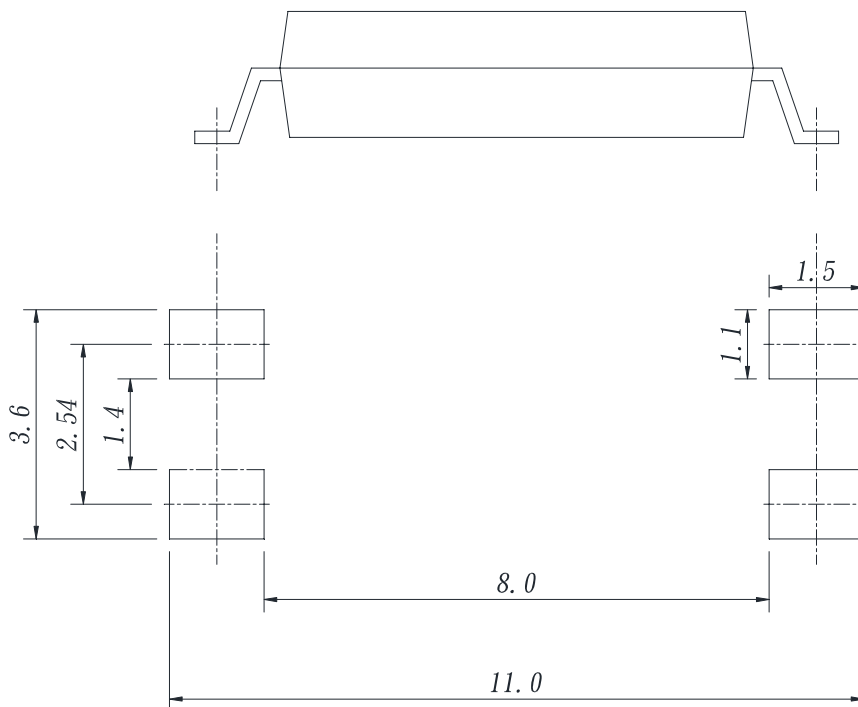

Unit : mm



● 4-pin LSOP Carrier Tape & Reel

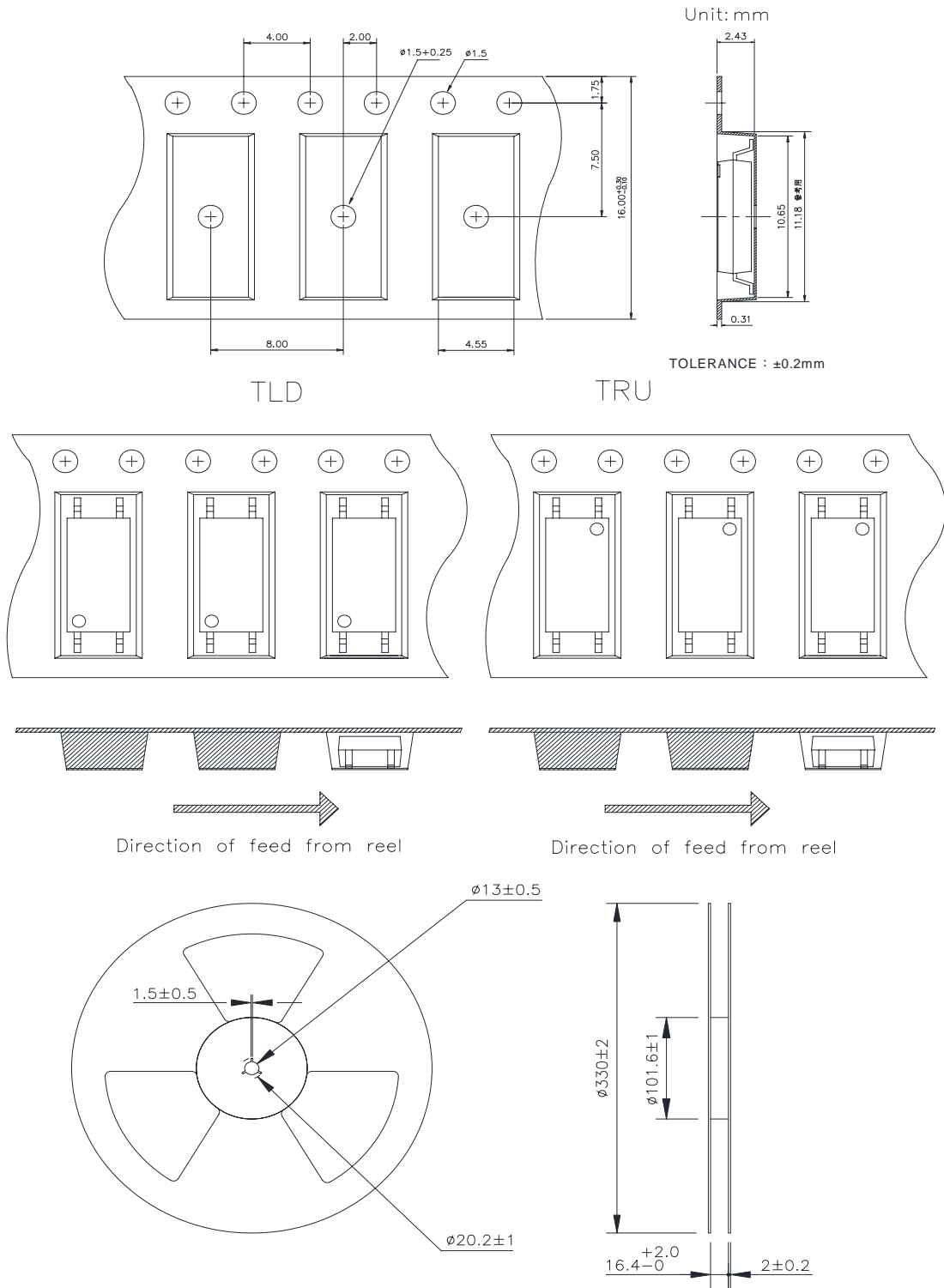

- **Application Notice**

The statements regarding the suitability of products for certain types of applications are based on cosmo's knowledge of general applications of cosmo products. Such statements are not binding statements about the suitability of products for a particular application. It is the customer's responsibility to verify the specifications are suitable for use in a particular application. Customers are solely responsible for all aspects of their own product design or applications. The parameters provided in the datasheet may vary in different applications and performance may vary over time. All operating parameters (including typical parameters) must be validated by customer's technical experts for different applications. cosmo assumes no liability for customer' product design or applications. Product specifications do not expand or otherwise change cosmo's terms and conditions of purchase, including but not limited to the warranty expressed therein.

When using cosmo products, please comply with safety standards and instructions. cosmo has no liability and responsibility to the damage caused by improper use of the instructions specified in the specifications.

cosmo products are designed for use in general electronic equipment such as telecommunications, office automation equipments, personal computers, test and measurement equipments, consumer electronics, industrial control, instrumentation, audio, video.

cosmo devices shall not be used in equipment that requires higher level of reliability and safety, such as nuclear power control equipment, telecommunication equipment(trunk lines), space application, medical and other life supporting equipments, and equipment for aircraft, military, automotive or any other application that can cause human injury or death.

cosmo reserves the right to change the specifications, data, characteristics, structure, materials and other contents at any time without notice. Please contact cosmo to obtain the latest specification.

cosmo disclaim any and all liability for any errors, inaccuracies or incompleteness contained in any datasheet or in any other disclosure relating to any product.