

PNP Silicon Epitaxial Planar Transistor

KTA1666

FEATURES

- High speed switching time.
- Low saturation voltage: $V_{CE(sat)} = -0.5V(\text{Max})$
- $P_C = 1 \sim 2W$ (Mounted on ceramic substrate)
- Small flat package.
- Complementary: KTC4379.



Lead-free

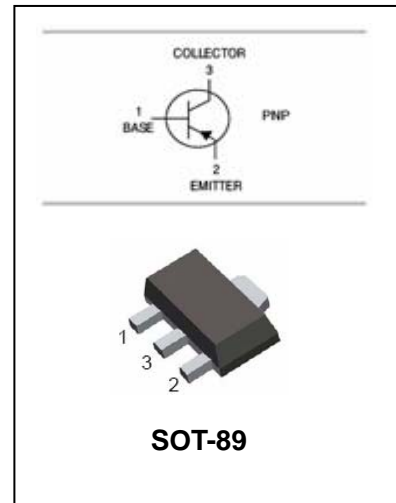

APPLICATIONS

- Power amplifier application.
- Power switching application.

ORDERING INFORMATION

Type No.	Marking	Package Code
KTA1666	W0/WY	SOT-89

MAXIMUM RATING @ $T_a = 25^\circ\text{C}$ unless otherwise specified

Symbol	Parameter	Value	Units
V_{CBO}	Collector-Base Voltage	-50	V
V_{CEO}	Collector-Emitter Voltage	-50	V
V_{EBO}	Emitter-Base Voltage	-5	V
I_C	Collector Current -Continuous	-2	A
I_B	Base Current	-0.4	A
P_C	Collector Dissipation	500	mW
T_j	Junction Temperature	150	$^\circ\text{C}$
T_{stg}	Storage Temperature Range	-55 to +150	$^\circ\text{C}$



PNP Silicon Epitaxial Planar Transistor

KTA1666

ELECTRICAL CHARACTERISTICS @ Ta=25°C unless otherwise specified

Parameter	Symbol	Test conditions	MIN	TYP	MAX	UNIT
Collector-base breakdown voltage	$V_{(BR)CBO}$	$I_C=-1mA, I_E=0$	-50			V
Collector-emitter breakdown voltage	$V_{(BR)CEO}$	$I_C=-10mA, I_B=0$	-50			V
Emitter-base breakdown voltage	$V_{(BR)EBO}$	$I_E=-1mA, I_C=0$	-5			V
Collector cut-off current	I_{CBO}	$V_{CB}=-50V, I_E=0$			-0.1	μA
Emitter cut-off current	I_{EBO}	$V_{EB}=-5V, I_C=0$			-0.1	μA
DC current gain	h_{FE}	$V_{CE}=-2V, I_C=-500mA$	70		240	
		$V_{CE}=-2V, I_C=-1.5A$	40			
Collector-emitter saturation voltage	$V_{CE(sat)}$	$I_C=-1A, I_B=-50mA$			-0.5	V
Base-emitter saturation voltage	$V_{BE(sat)}$	$I_C=-1A, I_B=-50mA$			-1.2	V
Transition frequency	f_T	$V_{CE}=-2V, I_C=-0.5A$		120		MHz
Collector output capacitance	C_{ob}	$V_{CB}=-10V, I_E=0, f=1MHz$		40		pF

CLASSIFICATION OF $h_{FE(1)}$

Rank	O	Y
Range	70-140	120-240
MARKING	WO	WY



PNP Silicon Epitaxial Planar Transistor

KTA1666

TYPICAL CHARACTERISTICS @ $T_a=25^\circ\text{C}$ unless otherwise specified

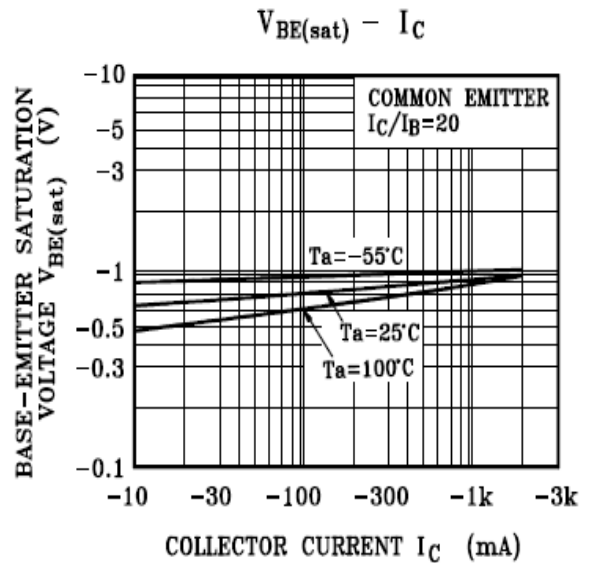
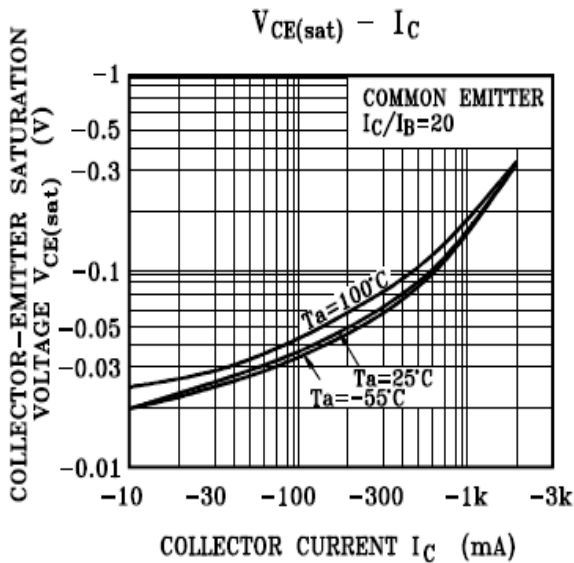
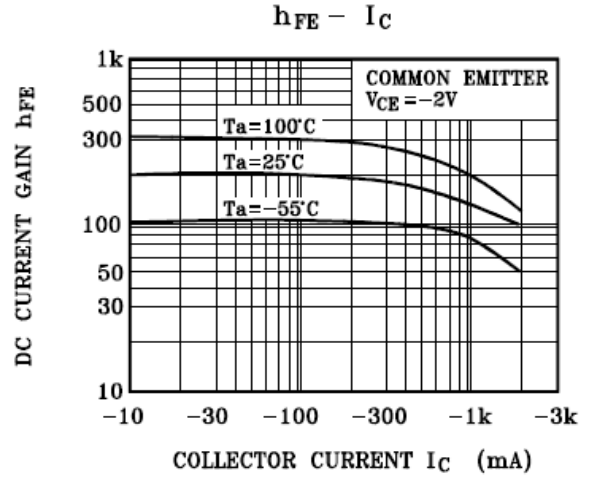
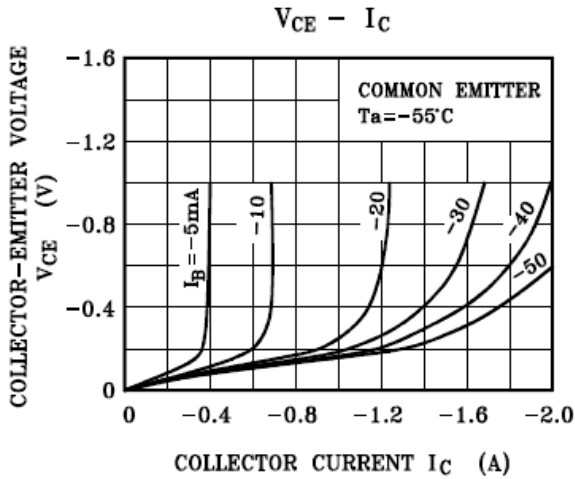
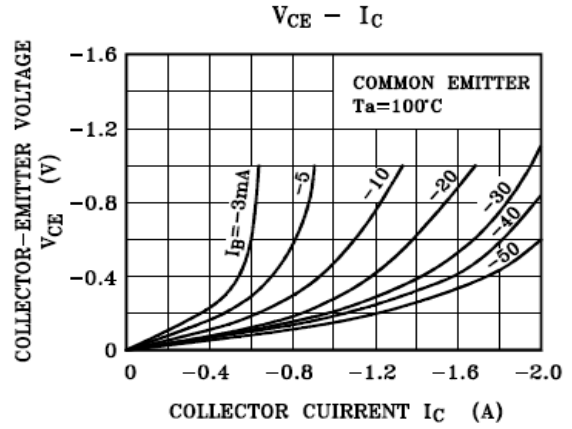
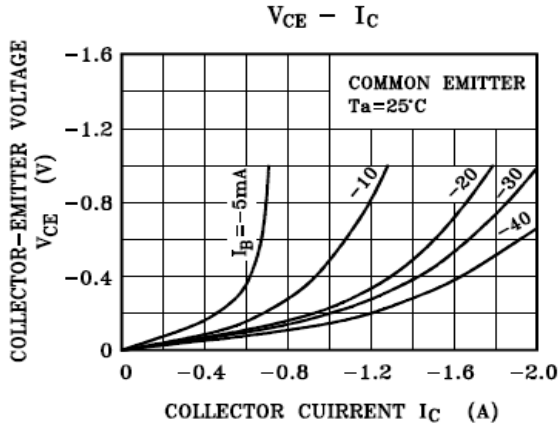

PNP Silicon Epitaxial Planar Transistor

KTA1666

PACKAGE OUTLINE

Plastic surface mounted package

SOT-89

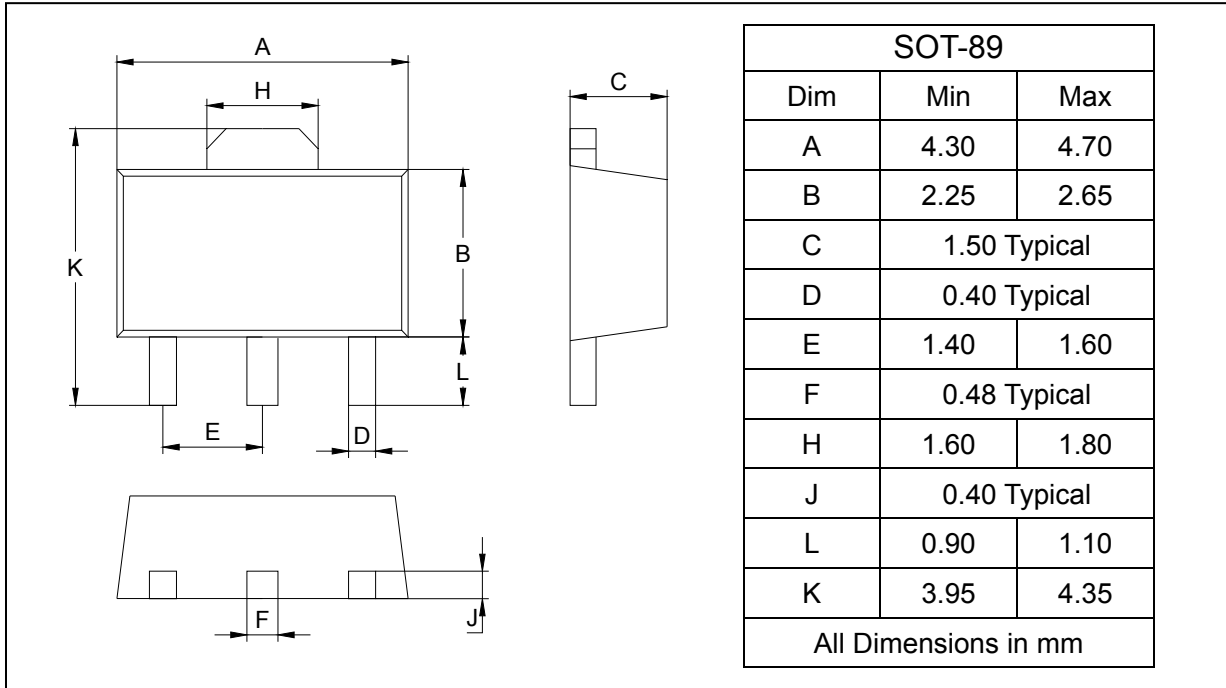

SOLDERING FOOTPRINT

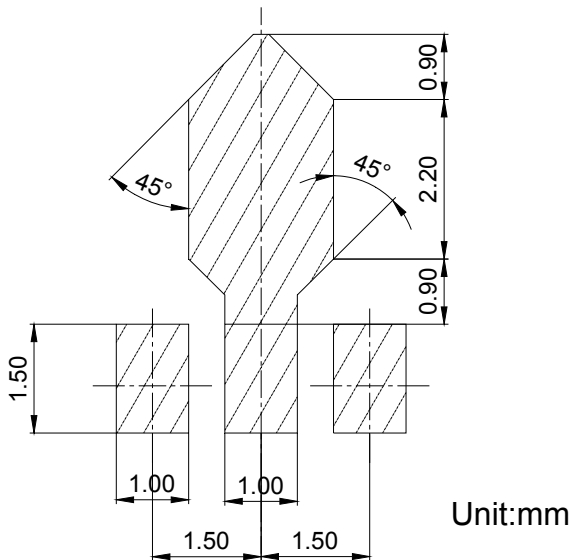

PACKAGE INFORMATION

Device	Package	Shipping
KTA1666	SOT-89	1000/Tape&Reel