

GENERAL PURPOSE APPLICATION.
SWITCHING APPLICATION.

FEATURES

- Excellent h_{FE} Linearity
: $h_{FE}(0.1mA)/h_{FE}(2mA)=0.95(Typ.)$.
- Low Noise : $NF=1dB(Typ.)$, $10dB(Max.)$.
- Complementary to KTC4075E.
- Small Package.

MAXIMUM RATING (Ta=25)

CHARACTERISTIC	SYMBOL	RATING	UNIT
Collector-Base Voltage	V_{CBO}	-50	V
Collector-Emitter Voltage	V_{CEO}	-50	V
Emitter-Base Voltage	V_{EBO}	-5	V
Collector Current	I_C	-150	mA
Base Current	I_B	-30	mA
Collector Power Dissipation	P_C	100	mW
Junction Temperature	T_j	150	
Storage Temperature Range	T_{stg}	-55 150	

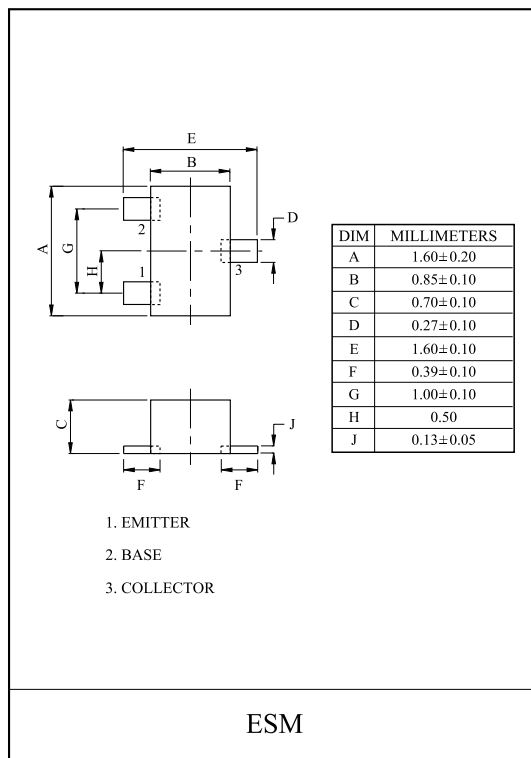

Marking

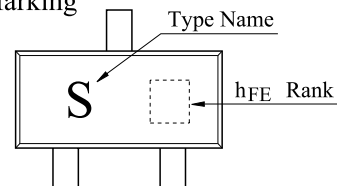

ELECTRICAL CHARACTERISTICS (Ta=25)

CHARACTERISTIC	SYMBOL	TEST CONDITION	MIN.	TYP.	MAX.	UNIT
Collector Cut-off Current	I_{CBO}	$V_{CB}=-50V, I_E=0$	-	-	-0.1	μA
Emitter Cut-off Current	I_{EBO}	$V_{EB}=-5V, I_C=0$	-	-	-0.1	μA
DC Current Gain	h_{FE} (Note)	$V_{CE}=-6V, I_C=-2mA$	70	-	400	
Collector-Emitter Saturation Voltage	$V_{CE(sat)}$	$I_C=-100mA, I_B=-10mA$	-	-0.1	-0.3	V
Transition Frequency	f_T	$V_{CE}=-10V, I_C=-1mA$	80	-	-	MHz
Collector Output Capacitance	C_{ob}	$V_{CB}=-10V, I_E=0, f=1MHz$	-	4	7	pF
Noise Figure	NF	$V_{CE}=-6V, I_C=-0.1mA$ $f=1kHz, R_g=10k$	-	1.0	10	dB

Note : h_{FE} Classification O(2):70 140, Y(4):120 240, GR(6):200 400

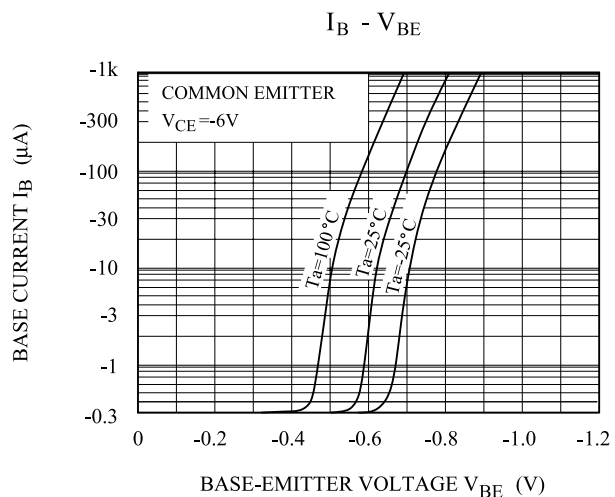
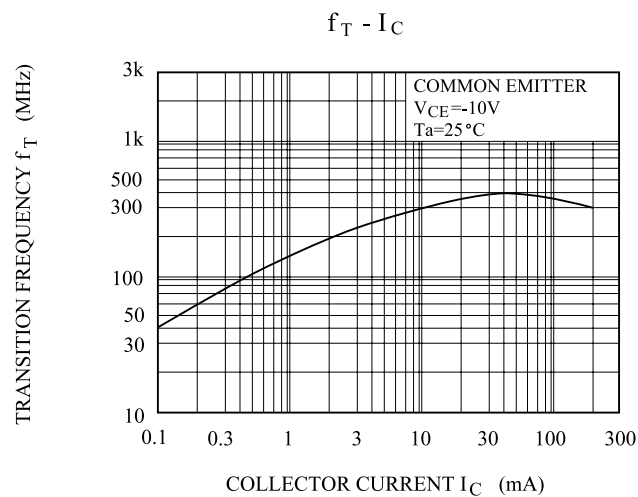
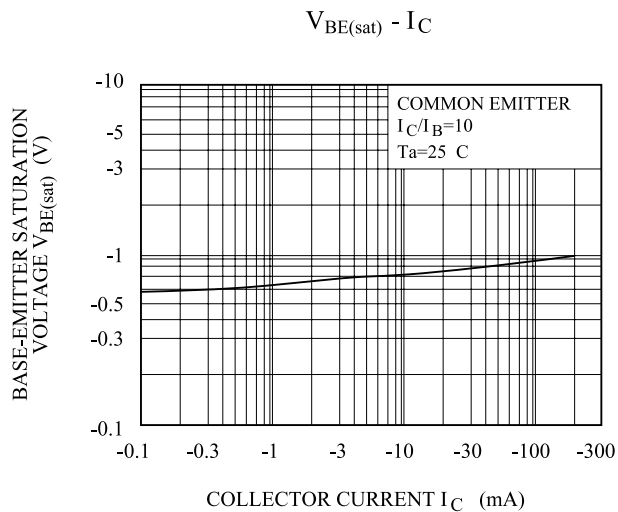
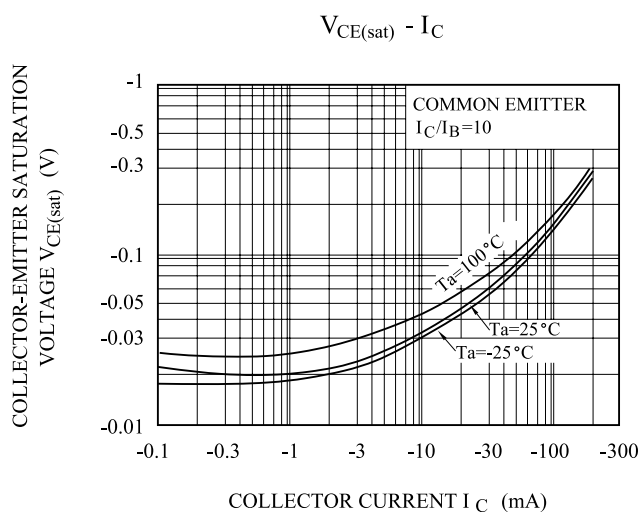
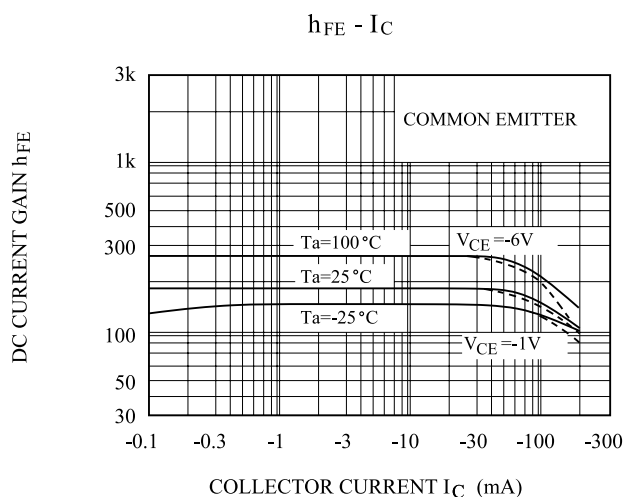
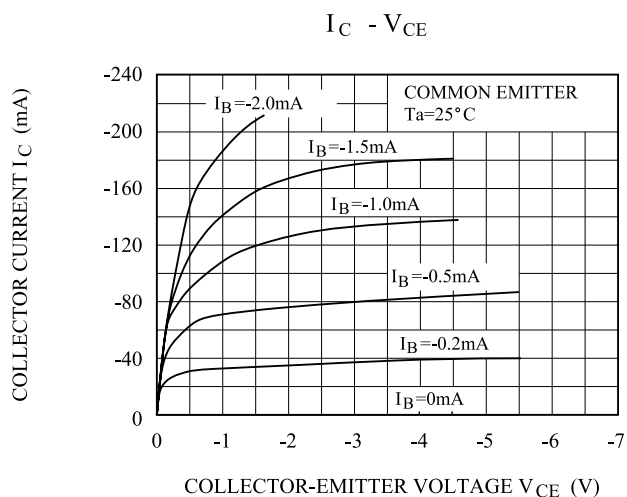

KTA2014E

