

KTC3875GR-G (NPN)

RoHS Device

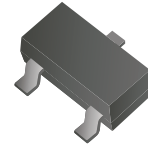

Features

- High hFE
- Low noise

Circuit Diagram

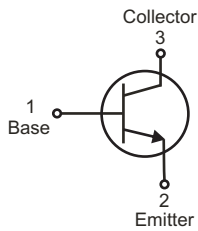

Maximum Ratings (at TA=25°C unless otherwise noted)

Parameter	Symbol	Value	Unit
Collector-Base voltage	V _{CB0}	60	V
Collector-Emitter voltage	V _{CEO}	50	V
Emitter-Base voltage	V _{EBO}	5	V
Collector current	I _C	150	mA
Collector power dissipation	P _C	150	mW
Thermal resistance from junction to ambient	R _{θJA}	833	°C/W
Junction temperature range	T _J	150	°C
Storage temperature range	T _{stg}	-55~+150	°C

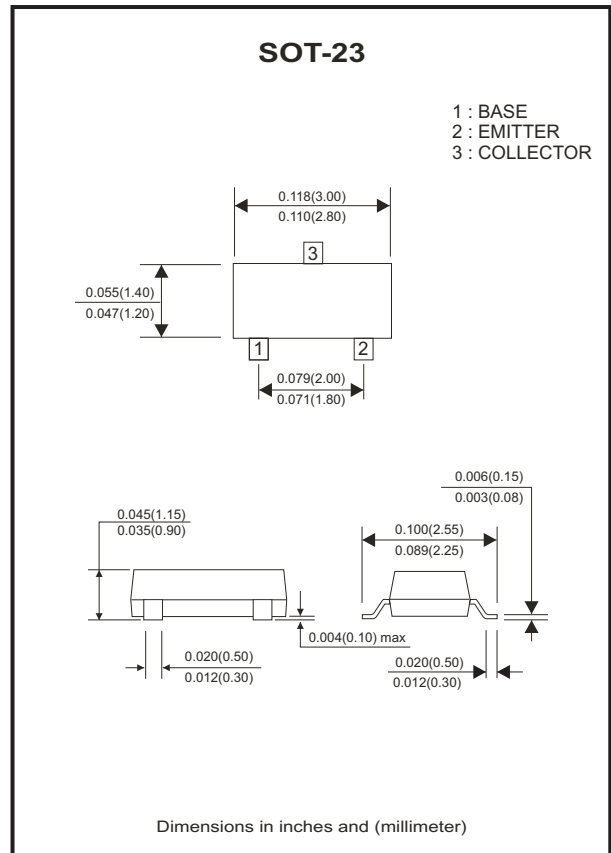

Electrical Characteristics (at TA=25°C unless otherwise noted)

Parameter	Conditions	Symbol	Min	Typ	Max	Unit
Collector-Base breakdown voltage	I _C =100μA, I _E =0	V _{(BR)CBO}	60			V
Collector-Emitter breakdown voltage	I _C =1mA, I _B =0	V _{(BR)CEO}	50			V
Emitter-Base breakdown voltage	I _E =100μA, I _C =0	V _{(BR)EBO}	5			V
Collector cut-off current	V _{CB} =60V, I _E =0	I _{CBO}			0.1	μA
Emitter cut-off current	V _{EB} =5V, I _C =0	I _{EBO}			0.1	μA
DC current gain	V _{CE} =6V, I _C =2mA	h _{FE}	200		400	
Collector-emitter saturation voltage	I _C =100mA, I _B =10mA	V _{CE(sat)}		0.1	0.25	V
Base-emitter saturation voltage	I _C =100mA, I _B =10mA	V _{BE(sat)}			1	V
Transition frequency	V _{CE} =10V, I _C =1mA	f _T	80			MHz
Collector output capacitance	V _{CB} =10V, I _E =0, f=1MHz	C _{ob}		2.0	3.5	pF
Noise figure	V _{CB} =6V, I _C =0.1mA, R _g =10kΩ, f=1KHz	NF		1.0	10	dB

RATING AND CHARACTERISTIC CURVES (KTC3875GR-G)

Fig.1 - Static Characteristic

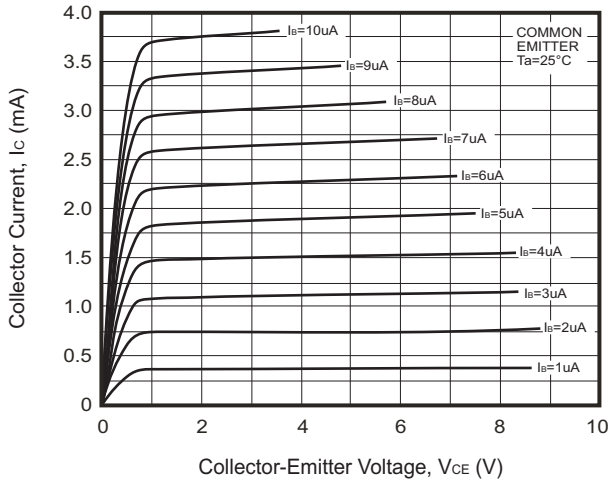

Fig.2 - $h_{FE} - I_c$

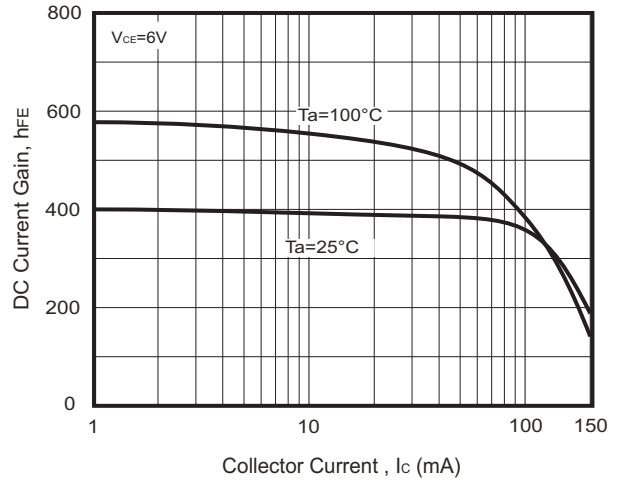

Fig.3 - $V_{BEsat} - I_c$

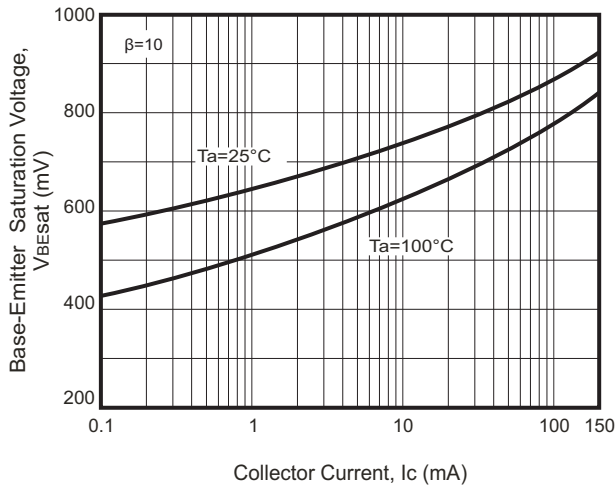

Fig.4 - $V_{CEsat} - I_c$

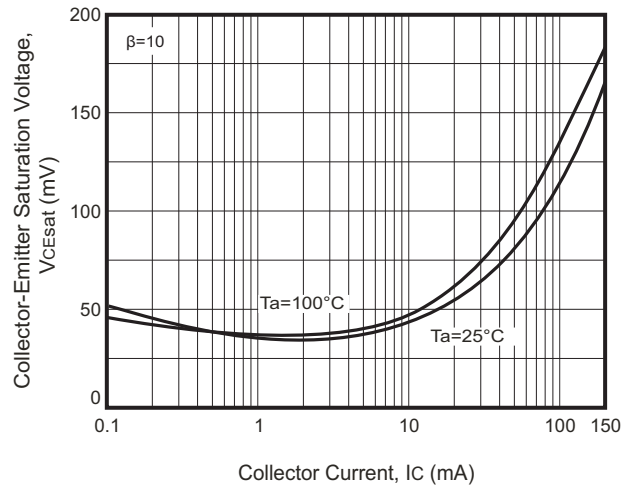

Fig.5 - $I_c - V_{BE}$

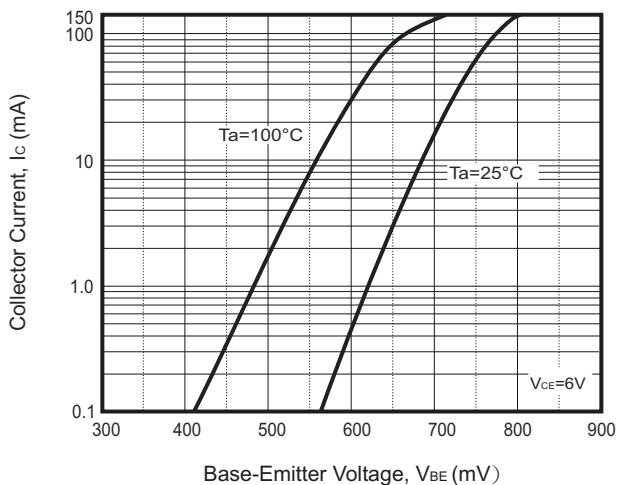
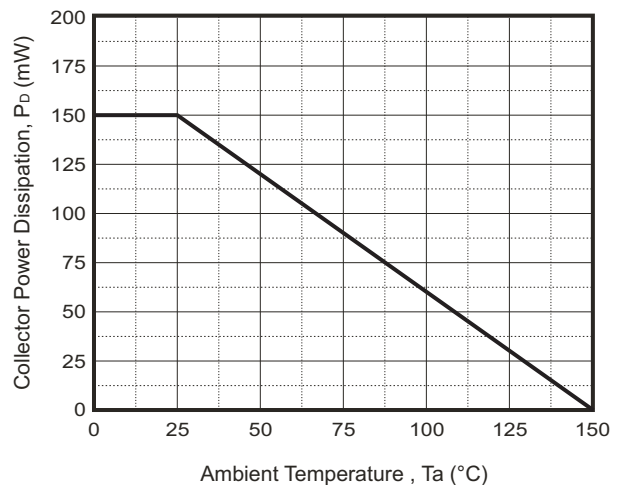
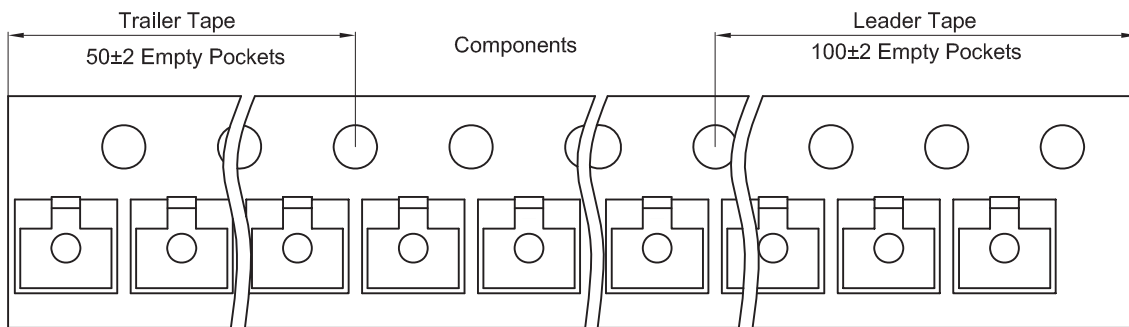
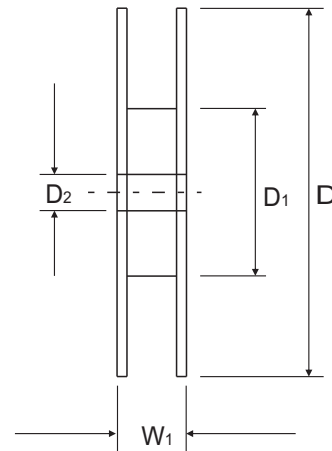
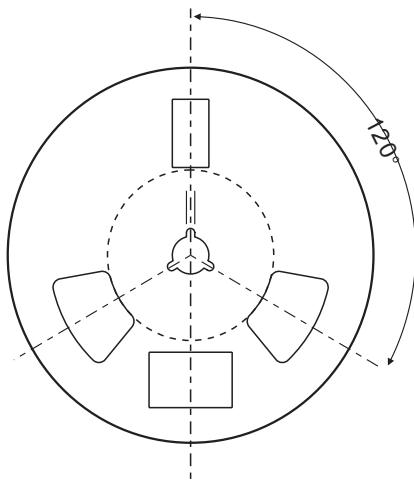
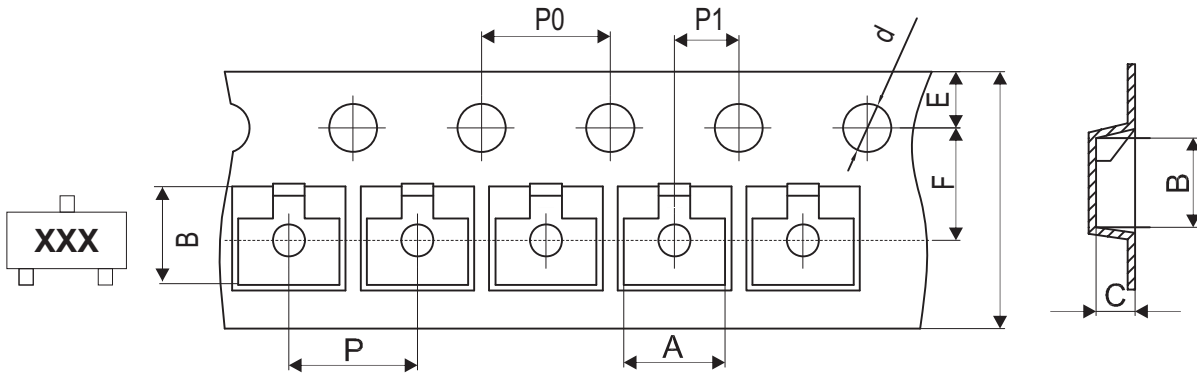

Fig.6 - $P_c - T_a$



Reel Taping Specification



SOT-23	SYMBOL	A	B	C	d	D	D1	D2
	(mm)	3.15 ± 0.10	2.77 ± 0.10	1.22 ± 0.10	1.50 ± 0.10	178.00 ± 2.00	54.40 ± 1.00	13.00 ± 1.00
	(inch)	0.124 ± 0.004	0.109 ± 0.004	0.048 ± 0.004	0.059 ± 0.004	7.008 ± 0.079	2.142 ± 0.039	0.512 ± 0.039

SOT-23	SYMBOL	E	F	P	P0	P1	W	W1
	(mm)	1.75 ± 0.10	3.50 ± 0.10	4.00 ± 0.10	4.00 ± 0.10	2.00 ± 0.10	8.00 + 0.30 / - 0.10	12.30 ± 1.00
	(inch)	0.069 ± 0.004	0.138 ± 0.004	0.157 ± 0.004	0.157 ± 0.004	0.079 ± 0.004	0.315 + 0.012 / - 0.004	0.484 ± 0.039

Company reserves the right to improve product design, functions and reliability without notice.

Marking Code

Part Number	Marking Code
KTC3875GR-G	ALG



Suggested PAD Layout

SIZE	SOT-23	
	(mm)	(inch)
A	0.80	0.031
B	0.60	0.024
C	1.90	0.075
D	2.02	0.080
E	2.82	0.111

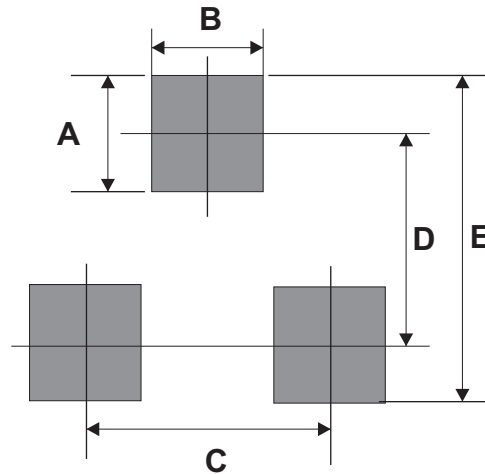

Standard Packaging

Case Type	REEL PACK	
	REEL (pcs)	Reel Size (inch)
SOT-23	3,000	7