



**KTD863**

**NPN SILICON TRANSISTOR**

**TRIPLE DIFFUSED NPN TRANSISTOR**

■ DESCRIPTION

The UTC **KTD863** is a triple diffused NPN transistor. it uses UTC's advanced technology to provide customers with high collector-emitter breakdown voltage and high collector current capability, etc.

The UTC **KTD863** is suitable for voltage regulator, relay and ramp driver, etc.

■ FEATURES

- \* High collector-emitter voltage
- \* High collector current capability

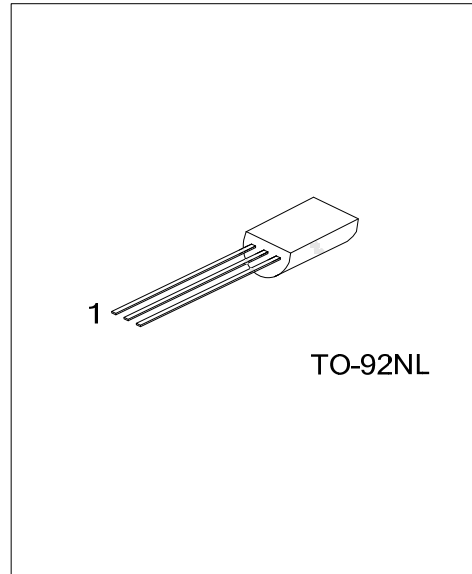

■ ORDERING INFORMATION

Ordering Number		Package	Pin Assignment			Packing
Lead Free	Halogen Free		1	2	3	
KTD863L-x-T9N-B	KTD863G-x-T9N-B	TO-92NL	E	C	B	Tape Box
KTD863L-x-T9N-K	KTD863G-x-T9N-K	TO-92NL	E	C	B	Bulk

Note: Pin Assignment: E: Emitter      C: Collector      B: Base

<p><b>KTD863G-x-T9N-B</b></p> <p>(1) Packing Type (2) Package Type (3) Rank (4) Green Package</p>	<p>(1) B: Tape Box, K: Bulk (2) T9N: TO-92NL (3) refer to CLASSIFICATION OF <math>h_{FE1}</math> (4) G: Halogen Free and Lead Free, L: Lead Free</p>
---	--

■ MARKING

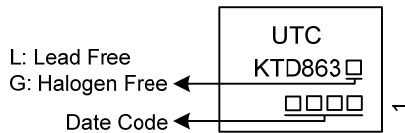

■ ABSOLUTE MAXIMUM RATINGS ( $T_A=25^\circ\text{C}$ , unless otherwise specified)

PARAMETER		SYMBOL	RATINGS	UNIT
Collector-Base Voltage		$V_{CBO}$	60	V
Collector-Emitter Voltage		$V_{CEO}$	60	V
Emitter-Base Voltage		$V_{EBO}$	5	V
Continuous Collector Current	DC	$I_C$	1	A
	Pulse	$I_{CP}$	2	A
Collector Power Dissipation		$P_C$	1	W
Junction Temperature		$T_J$	+150	$^\circ\text{C}$
Storage Temperature Range		$T_{STG}$	-55 ~ +150	$^\circ\text{C}$

Note: Absolute maximum ratings are stress ratings only and functional device operation is not implied.

Absolute maximum ratings are those values beyond which the device could be permanently damaged.

■ ELECTRICAL CHARACTERISTICS ( $T_A=25^\circ\text{C}$ , unless otherwise specified)

PARAMETER	SYMBOL	TEST CONDITIONS	MIN	TYP	MAX	UNIT
Collector-Emitter Breakdown Voltage	$BV_{CEO}$	$I_C=1\text{mA}, I_B=0$	60			V
Collector Cut-Off Current	$I_{CBO}$	$V_{CB}=50\text{V}, I_E=0$			1	$\mu\text{A}$
Emitter Cut-Off Current	$I_{EBO}$	$V_{EB}=4\text{V}, I_C=0$			1	$\mu\text{A}$
Collector-Emitter Saturation Voltage	$V_{CE(sat)}$	$I_C=500\text{mA}, I_B=50\text{mA}$		0.15	0.5	V
Base-Emitter Saturation Voltage	$V_{BE(sat)}$	$I_C=500\text{mA}, I_B=50\text{mA}$		0.85	1.2	V
DC Current Gain	$h_{FE1}$	$I_C=50\text{mA}, V_{CE}=2\text{V}$	60		320	
	$h_{FE2}$	$I_C=1\text{A}, V_{CE}=2\text{V}$	30			
Transition Frequency	$f_T$	$I_C=50\text{mA}, V_{CE}=10\text{V}$		150		MHz
Collector Output Capacitance	$C_{ob}$	$V_{CB}=10\text{V}, f=1\text{MHz}, I_E=0$		12		pF

■ CLASSIFICATION OF  $h_{FE1}$

RANK	O	Y	GR
RANGE	60~120	100~200	160~320

## TYPICAL CHARACTERISTICS

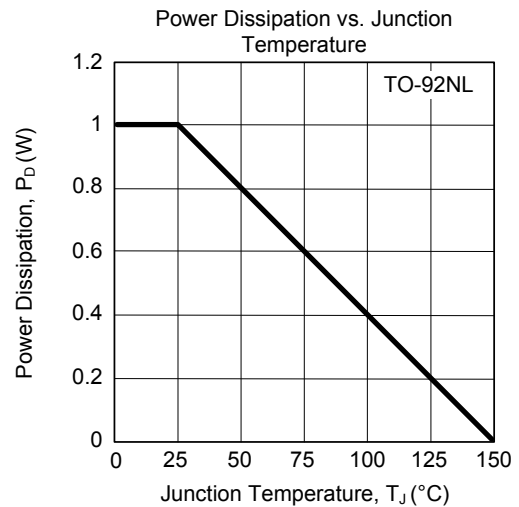
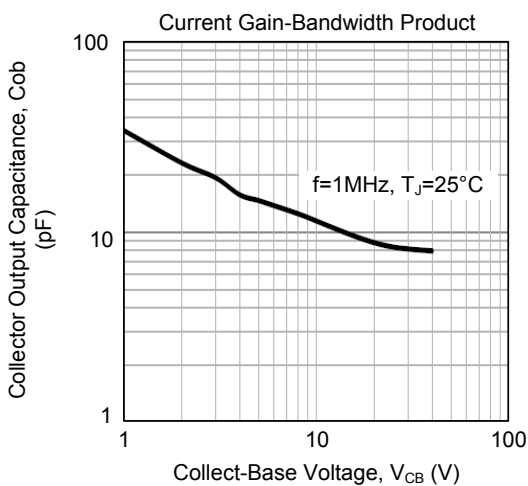
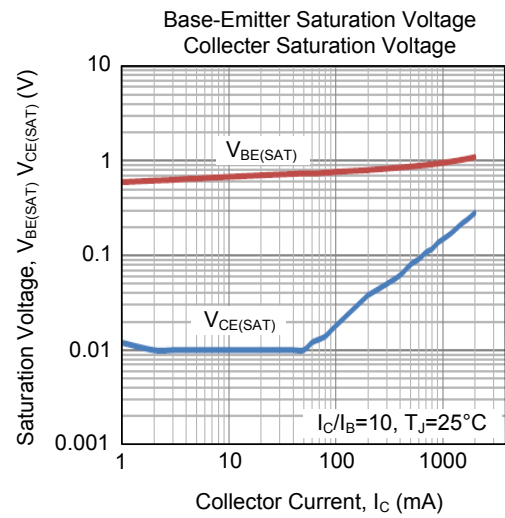
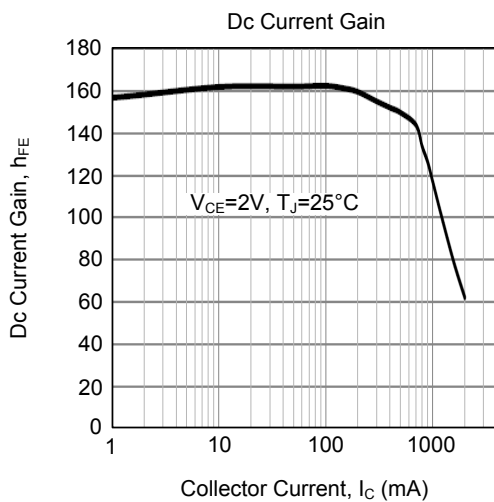
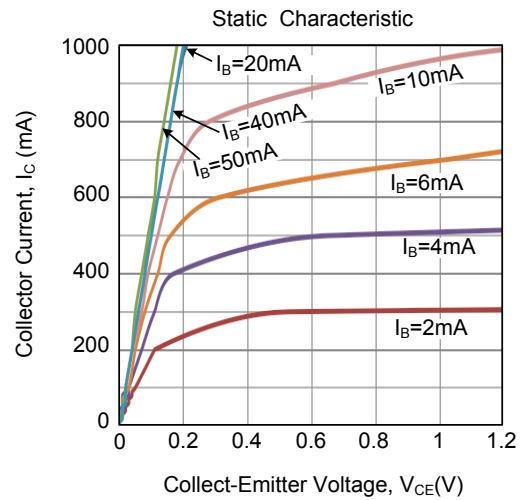
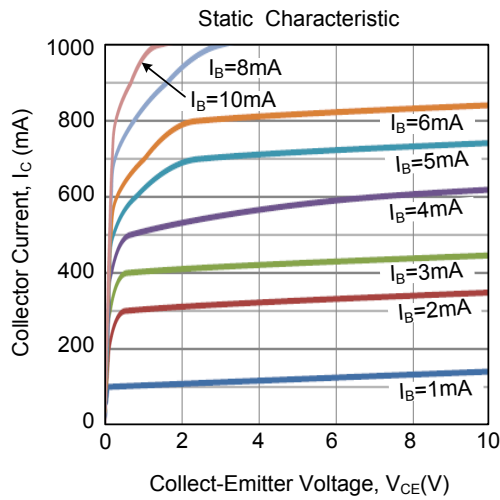

UTC assumes no responsibility for equipment failures that result from using products at values that exceed, even momentarily, rated values (such as maximum ratings, operating condition ranges, or other parameters) listed in products specifications of any and all UTC products described or contained herein. UTC products are not designed for use in life support appliances, devices or systems where malfunction of these products can be reasonably expected to result in personal injury. Reproduction in whole or in part is prohibited without the prior written consent of the copyright owner. UTC reserves the right to make changes to information published in this document, including without limitation specifications and product descriptions, at any time and without notice. This document supersedes and replaces all information supplied prior to the publication hereof.