

KTE3000 / KTU3000 Series

OEM pressure transmitters for industrial media



FEATURES

- 0...-1 to 0...50 bar, 0...-15 to 0...750 psi gage¹ or absolute
- For many industrial gases and liquids
- 0...10 V, 0.5...4.5 V, 0...5 V, 1...6 V or 4...20 mA output
- Field interchangeable
- For industrial use

MEDIA COMPATIBILITY

Wetted materials:
PPS, ceramic Al₂O₃ and NBR⁸

Housing:
stainless steel 1.4404 (316L), protection class IP 65 (according to DIN EN 60529) respectively NEMA 4X¹



SPECIFICATIONS^{10,11}

Maximum ratings

Supply voltage (reverse polarity protection)	
KTx3...0	13...32 V
KTx3...6	9...32 V
KTx3...1, ...7	8...32 V
KTx3...4 ²	7...32 V
Maximum load current	
Source/Sink	1 mA
Temperature limits	
Storage	-40...100°C
Operating	-25...85°C
Compensated	0...70°C
Humidity limits	0 - 95 %RH
Vibration (5 to 500 Hz)	10 g _{RMS}
Mechanical shock	50 g
Proof pressure ³	2 x rated pressure

ELECTRICAL CONNECTION

0...10 V, 0.5...4.5 V, 0...5 V, 1...6 V output

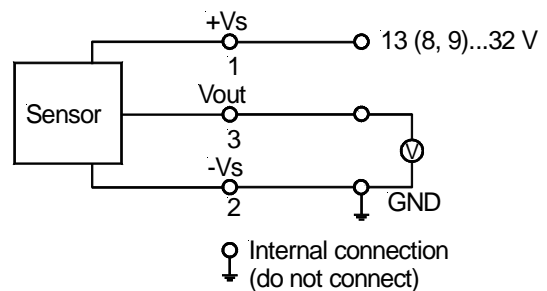

4... 20 mA output

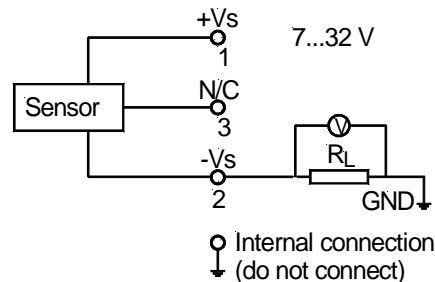

KTE3000 / KTU3000 Series

OEM pressure transmitters for industrial media

COMMON PERFORMANCE CHARACTERISTICS

($V_s = 15\text{ V}$, $R_L > 100\text{ k}\Omega$, $t_{\text{amb}} = 25^\circ\text{C}$)

Characteristics		Min.	Typ.	Max.	Unit	
Operating pressure	KTE3001...	0		1	bar	
	KTE3N01G..	-1		1		
	KTE3P01G..	-1		0		
	KTE3002...	0		2		
	KTE3005...	0		5		
	KTE3010...	0		10		
	KTE3016...	0		16		
	KTE3020...	0		20		
	KTE3025...	0		25		
	KTE3035...	0		35		
	KTE3050...	0		50		
	KTU3015...	0		15		psi
	KTU3N15G..	-15		15		
	KTU3P15G..	-15		0		
	KTU3030...	0		30		
	KTU3050...	0		50		
	KTU3100...	0		100		
	KTU3200...	0		200		
KTU3300...	0		300			
KTU3500...	0		500			
KTU3750...	0		750			
Thermal effects (0...70°C) ⁴	Offset		0.02	0.05	%FSO/°C	
	Span		0.02	0.05		
Thermal effects (-25...0°C, 70...85°C)	Offset		0.03			
	Span		0.03			
Non-linearity, hysteresis (BSL) and repeatability ⁵			±0.1	±0.3	%FSO	
Long term stability ⁶			±0.3			
Output noise (0 < f < 1 kHz)			±0.04			
Response time (10 to 90 %)			1	5	ms	
Power supply rejection			0.005		%FSO/V	

Specification notes:

- IP 65 protection is given when the connector is locked with a rubber washer. For proper function the gage port is vented to the atmosphere through the connector/cable assembly. Thus the cable end must have access to the ambient pressure.
- The minimum supply voltage is directly proportional to the load resistance seen by the transmitter. For more details see the load limitation diagram.
- Proof pressure is the maximum pressure which may be applied without causing damage to the sensing element.
- Thermal effects tested and guaranteed from 0 to 70°C relative to 25°C. All specifications shown are relative to 25°C.
- Non-linearity refers to the **Best Straight Line** fit measured for offset, full scale span and 1/2 full scale span.
- Long term stability is the change in output after one year or 1 million pressure cycles.
- Span is the arithmetic difference in transmitter output signal measured at zero pressure and the maximum operating pressure.
- Other sealing materials are available on request.
- Test are in accordance with EN61000-6-2, April 1999.
- CE-labelling is in accordance with 89/336/EEC.
- The pressure transmitters must not be used as safety accessories according to article 1, 2.1.3 of the directive 97/23/EC.

KTE3000 / KTU3000 Series

OEM pressure transmitters for industrial media

INDIVIDUAL PERFORMANCE CHARACTERISTICS

0...10 V output ($V_s = 15\text{ V}$, $R_L > 100\text{ k}\Omega$, $t_{amb} = 25^\circ\text{C}$)

Characteristics		Min.	Typ.	Max.	Unit
Zero pressure offset	KT...3N...	4.9	5	5.1	V
	all others		0.03	0.1	
Full scale span ⁷	KT...3N...	4.9	5	5.1	
	all others	9.9	10	10.1	
Output impedance				25	Ω
Current consumption (no load)			3	5	mA

0.5...4.5 V output ($V_s = 15\text{ V}$, $R_L > 100\text{ k}\Omega$, $t_{amb} = 25^\circ\text{C}$)

Characteristics		Min.	Typ.	Max.	Unit
Zero pressure offset	KT...3N...	2.45	2.5	2.55	V
	all others	0.45	0.5	0.55	
Full scale span ⁷	KT...3N...	1.95	2	2.05	
	all others	3.95	4	4.05	
Output impedance				25	Ω
Current consumption (no load)			3	5	mA

0...5 V output ($V_s = 15\text{ V}$, $R_L > 100\text{ k}\Omega$, $t_{amb} = 25^\circ\text{C}$)

Characteristics		Min.	Typ.	Max.	Unit
Zero pressure offset	KT...3N...	2.45	2.5	2.55	V
	all others		0.03	0.08	
Full scale span ⁷	KT...3N...	2.45	2.5	2.55	
	all others	4.95	5.0	5.05	
Output impedance				25	Ω
Current consumption (no load)			3	5	mA

1...6 V output ($V_s = 15\text{ V}$, $R_L > 100\text{ k}\Omega$, $t_{amb} = 25^\circ\text{C}$)

Characteristics		Min.	Typ.	Max.	Unit
Zero pressure offset	KT...3N...	3.45	3.5	3.55	V
	all others	0.95	1	1.05	
Full scale span ⁷	KT...3N...	2.45	2.5	2.55	
	all others	4.95	5.0	5.05	
Output impedance				25	Ω
Current consumption (no load)			3	5	mA

4...20 mA output ($V_s = 15\text{ V}$, $R_L = 100\ \Omega$, $t_{amb} = 25^\circ\text{C}$)

Characteristics		Min.	Typ.	Max.	Unit
Zero pressure offset	KT...3N...	11.9	12.0	12.1	mA
	all others	3.9	4.0	4.1	
Full scale span ⁷	KT...3N...	7.9	8.0	8.1	
	all others	15.9	16.0	16.1	
Power consumption ($I_L = 20\text{ mA}$)			250		mW

KTE3000 / KTU3000 Series

OEM pressure transmitters for industrial media

OUTPUT CHARACTERISTICS

0...10 V output version

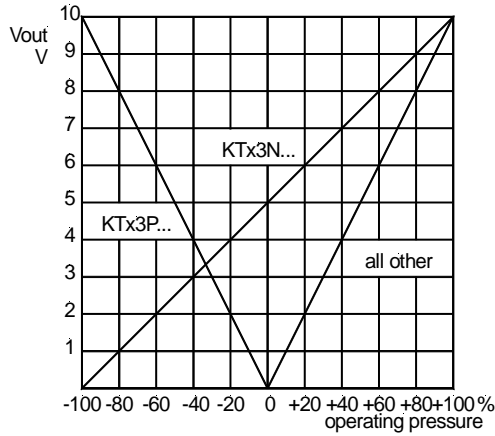

0.5...4.5 V output version

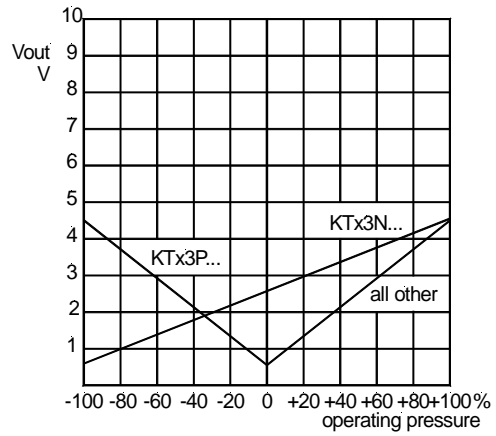

0...5 V output version

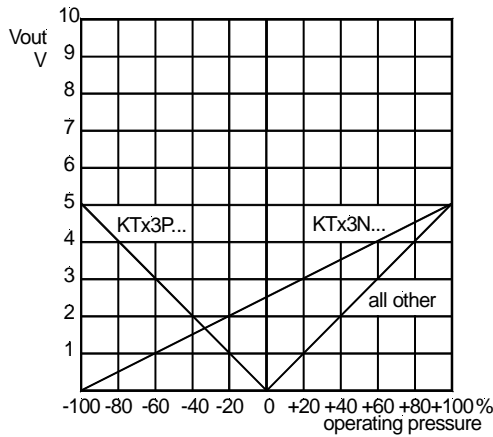

1...6 V output version

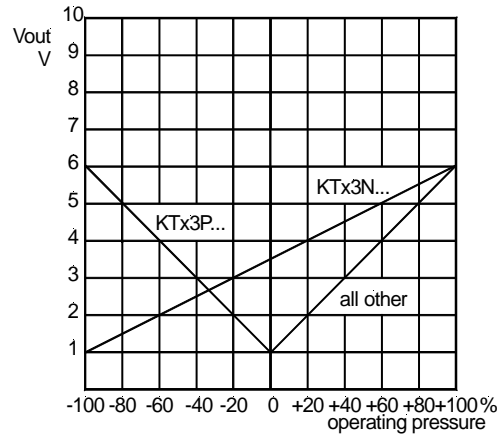

4...20 mA output version

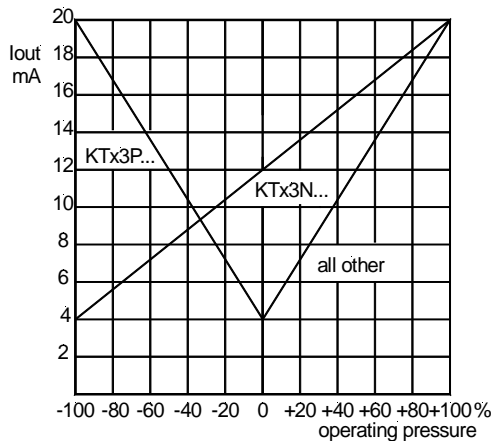

KTE3000 / KTU3000 Series

OEM pressure transmitters for industrial media

OUTLINE DRAWING

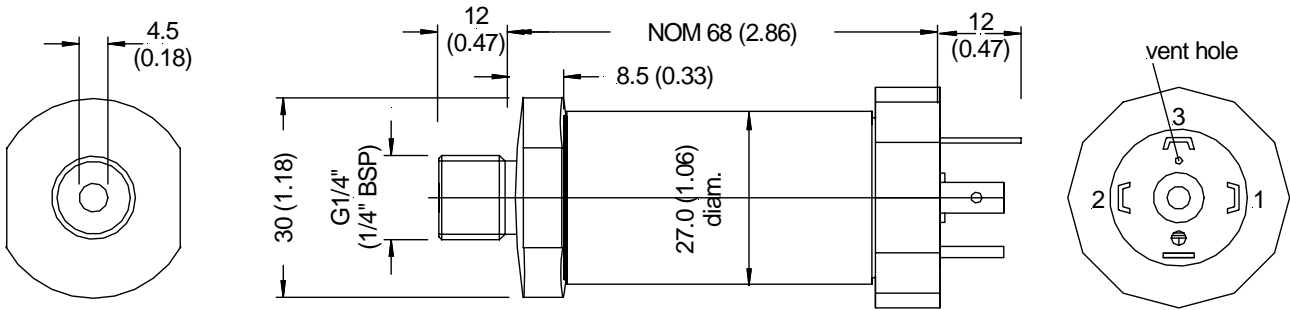

mass: 210 g

dimensions in mm (inches)

LOAD LIMITATION

4...20 mA output version

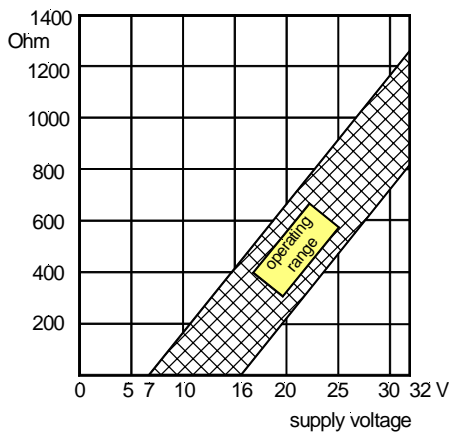

RECOMMENDED ACCESSORY

Plug **DIN EN 175301-803 A** and profile washer included in delivery. For a complete connector/cable assembly use order no. **ZK000110-x** (x=cable lengths in m).

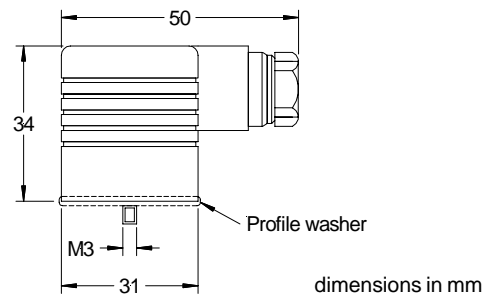

Note:

For proper function of all gage devices the gage port must be vented to the atmosphere through the connector/cable assembly.

KTE3000 / KTU3000 Series

OEM pressure transmitters for industrial media

ELECTROMAGNETIC CAPABILITY⁹

	Test conditions	Criterion	Interference
Radiated, radio frequency electromagnetic field immunity (RFI)	EN61000-4-3: Grade 3, 10 V/m, 80 to 1000 MHz 80 % AMC (1 kHz)	A	<1 %FSO
Electrical fast transient / burst immunity (EFT)	EN61000-4-4: Grade 3, ±2 kV	B	<1 %FSO
Electrostatic discharge immunity test (ESD)	EN61000-4-2: Grade 4, ±8 kV, contact discharge	B	<1 %FSO
Immunity to conducted disturbances induced by radio-frequency fields	EN61000-4-6: Grade 3, 0.15 to 80 MHz 10 V, 80 % AMC (1 kHz)	A	<1 %FSO

ORDERING INFORMATION

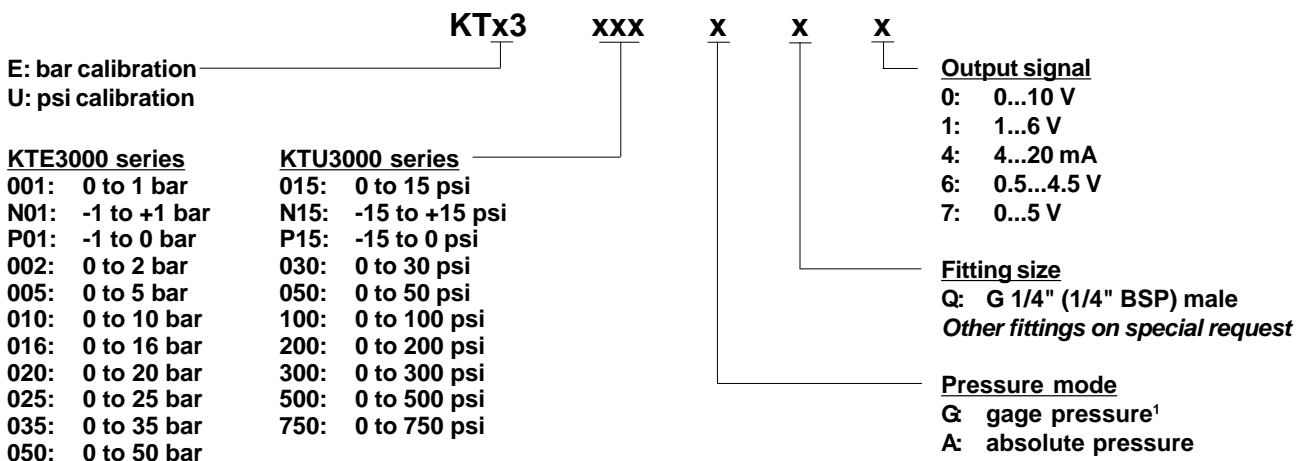

Note: Other pressure ranges and options are widely available.
Please contact your nearest Sensortechincs sales representative.

Sensortechincs reserves the right to make changes to any products herein. Sensortechincs does not assume any liability arising out of the application or use of any product or circuit described herein, neither does it convey any license under its patent rights nor the rights of others.