

SONY[®]

3-866-871-22

Trinitron[®]
Color TV

Operating Instructions

KV-20FV10
KV-24FV10

L

© 1999 by Sony Corporation

WARNING

To reduce the risk of fire or shock hazard, do not expose the TV to rain or moisture.

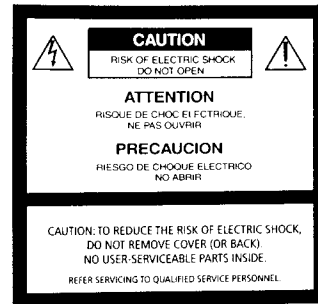

This symbol is intended to alert the user to the presence of uninsulated “dangerous voltage” within the product’s enclosure that may be of sufficient magnitude to constitute a risk of electric shock to persons.



This symbol is intended to alert the user to the presence of important operating and maintenance (servicing) instructions in the literature accompanying the appliance.

Note to the CATV Installer

This reminder is provided to call the CATV system installer’s attention to Article 820-40 of the NEC that provides guidelines for proper grounding and, in particular, specifies that the cable ground shall be connected to the grounding system of the building as close to the point of cable entry as practical.

SAFETY PRECAUTIONS

- Operate the TV only on 120 V AC.
- One blade of the power plug is wider than the other for safety purposes and will fit into the power outlet only one way. If you are unable to insert the plug fully into the outlet, contact your dealer.
- If any liquid or solid object falls into the TV, unplug it and have it checked by qualified personnel before operating it further.

For more safety information, see the “IMPORTANT SAFEGUARDS” leaflet packed with your TV.

CAUTION

When using TV games, computers, and similar products with your TV, keep the brightness and contrast functions at low settings. If a fixed (non-moving) pattern is left on the screen for long periods of time at a high brightness or contrast setting, the image can be permanently imprinted onto the screen. Continuously watching the same channel can cause the imprint of station logos onto the TV screen. These types of imprints are not covered by your warranty because they are the results of misuse.



To reduce the risk of electric shock, do not use this polarized plug with an extension cord, receptacle, or other outlet unless the blades can be fully inserted to prevent blade exposure.

 You are cautioned that any changes or modifications not expressly approved in this manual could void your authority to operate this equipment.

NOTIFICATION

This equipment has been tested and found to comply with the limits for a Class B digital device pursuant to Part 15 of the FCC Rules. These limits are designed to provide reasonable protection against harmful interference in a residential installation. This equipment generates, uses, and can radiate radio frequency energy and, if not installed and used in accordance with the instructions, may cause harmful interference with radio communications. However, there is no guarantee that interference will not occur in a particular installation. If this equipment does cause harmful interference to radio or television reception, which can be determined by turning the equipment off and on, the user is encouraged to try to correct the interference by one or more of the following measures:

- Reorient or relocate the receiving antennas.
- Increase the separation between the equipment and receiver.
- Connect the equipment into an outlet on a circuit different from that to which the receiver is connected.
- Consult the dealer or an experienced radio/TV technician for help.

Protecting the TV

- To prevent internal heat build-up, do not block the ventilation openings.
- Do not install the TV in a hot or humid place, or in a place subject to excessive dust or mechanical vibration.

Note on CAPTION VISION

This television receiver provides display of television closed captioning in accordance with § 15.119 of the FCC rules.

Use of this television for other than private viewing of programs broadcast on UHF or VHF or transmitted by cable companies for the use of the general public may require authorization from the broadcaster-cable company and/or program owner.

Owner's Record

The model and serial numbers are located on the front cover of this instruction manual.

Trademarks and Copyrights

ENERGY STAR® is a registered mark.

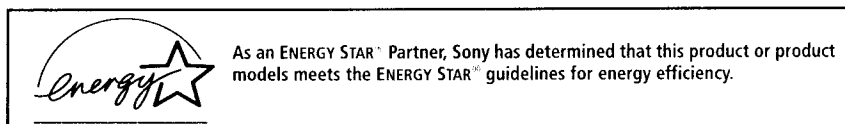

● SRS (SOUND RETRIEVAL)

The ● SRS (SOUND RETRIEVAL SYSTEM) is manufactured by Sony Corporation under license from SRS Labs, Inc. It is covered by U.S. Patent No. 4,748,669. Other U.S. and foreign patents pending.

The word 'SRS' and the SRS symbol (●) are registered trademark of SRS Labs, Inc.

Licensed by BBE Sound, Inc. under USP 4638258.4482866. BBE and BBE symbol are trademarks of BBE Sound, Inc.

Contents

Introduction

Trinitron® Color TV Features	1
Batteries for the Remote Control.....	2
About this Manual	2

Connecting Your TV

Basic Connections.....	3
Connecting Additional Equipment	4

Using the Remote Control and Basic Functions

Setting up the TV Automatically	13
Quick Start to the Menus.....	14

Using the Menus

Using the VIDEO menu	15
Using the AUDIO menu	16
Using the TIMER menu	18
Using the SET UP menu	19
Using PARENTAL CONTROL	22

Other Information

Programming the Remote Control	29
Troubleshooting	32
Specifications.....	34

Index	35
--------------------	----

Introduction

Congratulations on your purchase of the Sony Trinitron® Color TV. Before you begin using this manual, please check the model number located on the front cover of this instruction manual.

The menu and illustrations used in these instructions are for KV-24FV10 to show the maximum number of features available. Differences in operation or features will be indicated in the text, for example, "KV-24FV10 only."

Trinitron® Color TV Features



Depending on your TV, some of the features you will enjoy include:

- ❑ **Flat CRT** — For optimal picture quality.
- ❑ **PARENTAL CONTROL** — A tool for parents to help monitor what their children watch on TV by establishing rating limits.
- ❑ **FAVORITE CHANNEL** — Instant access to your favorite channels with the touch of a button.
- ❑ **Universal Remote Control** — Program your remote control to operate your connected cable box, VCR, digital satellite receiver or DVD player.
- ❑ **Trilingual Menus** — Choose English, French or Spanish menus.
- ❑ **Energy Star** — A recognized symbol of energy efficiency.
- ❑ **S VIDEO** — A video input that offers enhanced picture quality.
- ❑ **Direct MTS** — Allows direct access to changing your Multi-Channel TV Sound: STEREO, SAP (Second Audio Program), or MONO, with the touch of a button.
- ❑ **Front Panel Controls** — Allows for access to the on-screen menus without the use of a remote control.
- ❑ **Front A/V inputs** — A quick connection for video games, camcorders or stereo equipment.

Batteries for the Remote Control

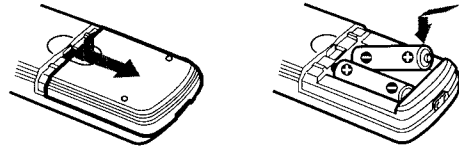
Insert two AA (R6) batteries (supplied) into the remote control using the following illustration as a guide.



-  Under normal conditions, batteries will last up to six months. If the remote control does not operate properly, the batteries might be worn out.
-  Remove the batteries to avoid possible damage from battery leakage if you will not be using the remote control for an extended period of time.
-  Your remote control can be programmed to operate most video equipment, (see page 29).

About this Manual

This manual provides instructions to help you enjoy your new TV. It shows you how to connect to an antenna or cable, cable box, VCR, DVD, satellite receiver, stereo system or camcorder. Once you're connected, follow the instructions to learn how to use the remote control to access the on-screen menus.

Connecting Your TV

Read this chapter before setting up your TV for the first time. This section covers basic connections in addition to any optional equipment you may be connecting.

Basic Connections

TV with indoor or outdoor antenna, or CATV cable

Depending on the cable available in your home, choose one of the connections below:

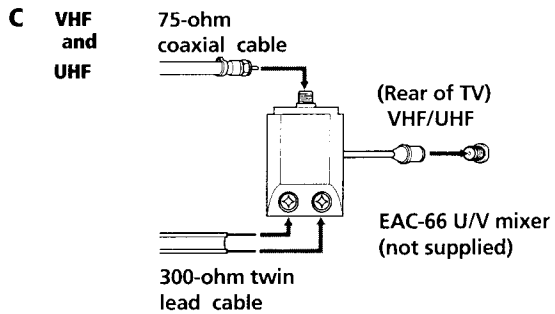
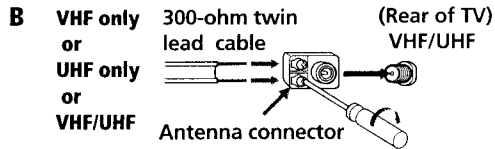
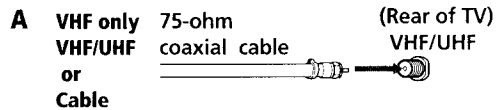

 If you are connecting to an indoor or outdoor antenna, it will be necessary to adjust the orientation of the antenna for best reception.

Connecting Additional Equipment

TV and VCR

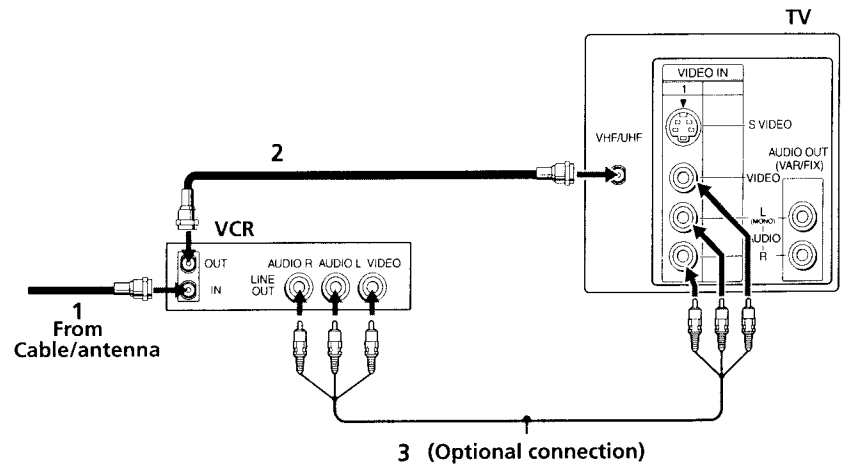

- 1** Connect the coaxial cable from your TV antenna or cable TV to the IN jack on your VCR.
- 2** Connect a coaxial cable (not supplied) from the OUT jack on your VCR to the VHF/UHF IN jack on the TV.

 To watch video programs from your VCR, tune your TV to channel 3 or 4 (as set on the rear of your VCR).

(Optional connection)

- 3** If your VCR is equipped with video inputs, for better picture quality you should connect A/V cables from AUDIO and VIDEO OUT on your VCR to AUDIO/VIDEO IN on your TV. You can use the  button to switch between the TV and VCR inputs.

 For optimum picture quality, use S VIDEO instead of the yellow A/V cable. S VIDEO does not provide sound, the audio cables must still be connected.

TV and Cable Box

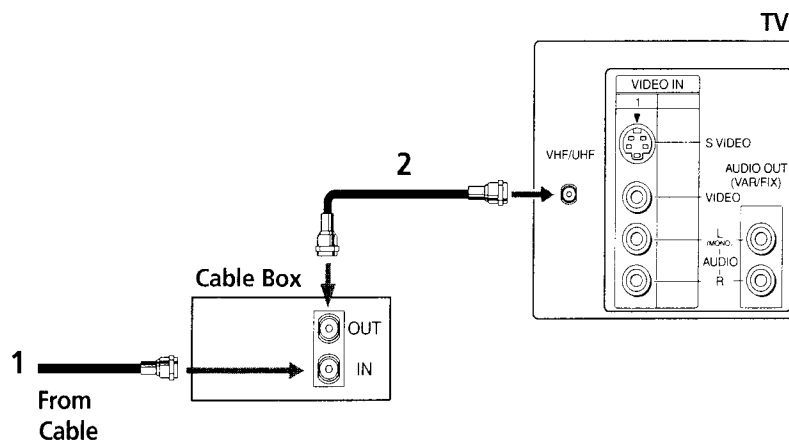

- 1** Connect the coaxial cable from the wall to the IN jack on your cable box.
- 2** Connect a coaxial cable (not supplied) from the OUT jack on your cable box to the VHF/UHF IN jack on the TV.

 To view channels from your cable box, tune your TV to channel 3 or 4 (as set on the rear panel of your cable box).

 If you will be controlling all channel selection through your cable box, you should consider using the CHANNEL FIX feature on page 20.

TV, VCR, and Cable box

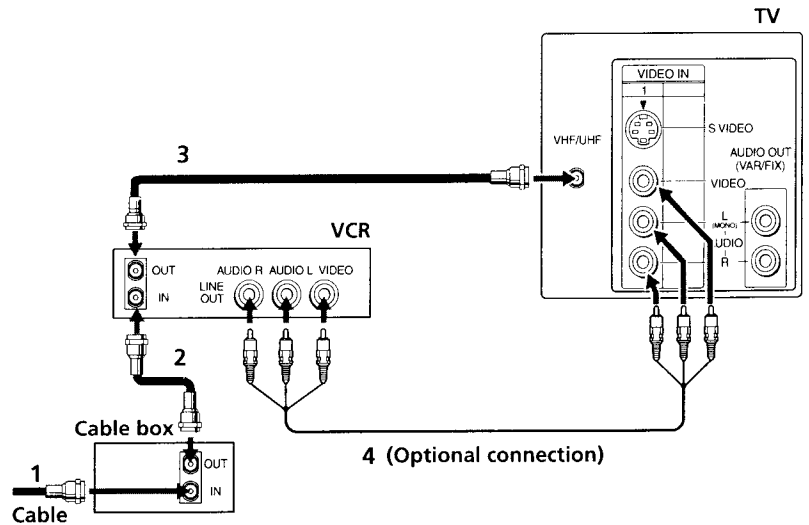

- 1** Connect the coaxial cable from the wall to the IN jack on your cable box.
- 2** Connect a coaxial cable (not supplied) from the OUT jack on your cable box to the IN jack on your VCR.
- 3** Connect a coaxial cable (not supplied) from the OUT jack on your VCR to the VHF/UHF IN jack on the TV.

 If you will be controlling all channel selection through your cable box, you should consider using the CHANNEL FIX feature on page 20.

(Optional connection)

- 4** If your VCR is equipped with video inputs, for better picture quality you should connect A/V cables from AUDIO and VIDEO OUT on your VCR to AUDIO/VIDEO IN on your TV. You can use the  button to switch between the TV and VCR inputs.

 For optimum picture quality, use S VIDEO instead of the yellow AV cable. S VIDEO does not provide sound, the audio cables must still be connected.

TV and Digital Satellite Receiver

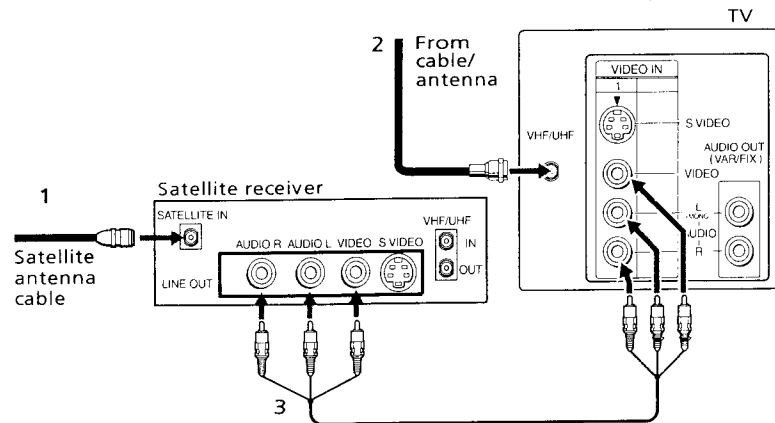

- 1** Connect the cable from your satellite antenna to SATELLITE IN on the satellite receiver.
- 2** Attach the coaxial connector from your cable or antenna to VHF/UHF on your TV.
- 3** Using A/V connectors, connect AUDIO and VIDEO OUT on your satellite receiver to AUDIO and VIDEO IN on your TV.

 You can use the  button to switch between the satellite receiver and TV.

 For optimum picture quality, use S VIDEO instead of the yellow A/V cable. S VIDEO does not provide sound, your audio connectors must still be connected.

TV, Digital Satellite Receiver and VCR

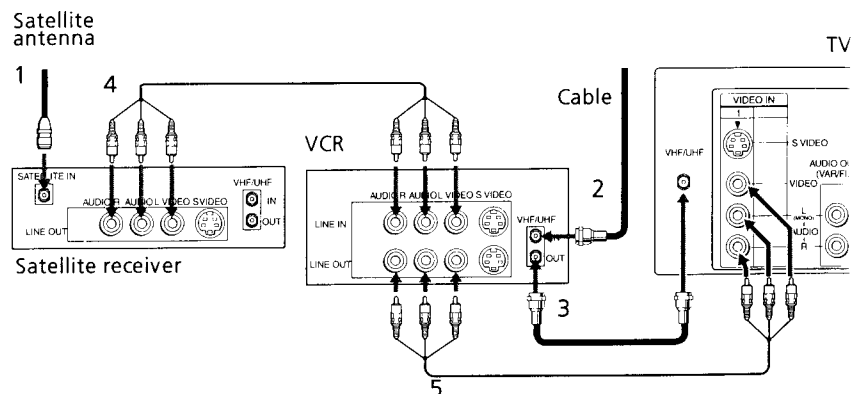

- 1** Connect the cable from your satellite antenna to SATELLITE IN on the satellite receiver.
- 2** Attach the coaxial connector from your cable or antenna to VHF/UHF IN on your VCR.
- 3** Using a coaxial cable, connect VHF/UHF OUT on your VCR to VHF/UHF on your TV.
- 4** Using A/V connectors, connect AUDIO and VIDEO OUT on your satellite receiver to AUDIO and VIDEO IN on your VCR.
- 5** Using A/V connectors, connect AUDIO and VIDEO OUT on your VCR to AUDIO and VIDEO IN on your TV.

 To view from the satellite or VCR, select the video input to which your satellite receiver or VCR is connected by pressing **TV VIDEO** on the remote control.

Connecting a Camcorder

Using A/V cables, connect AUDIO and VIDEO OUT on your camcorder to AUDIO and VIDEO IN on your TV.

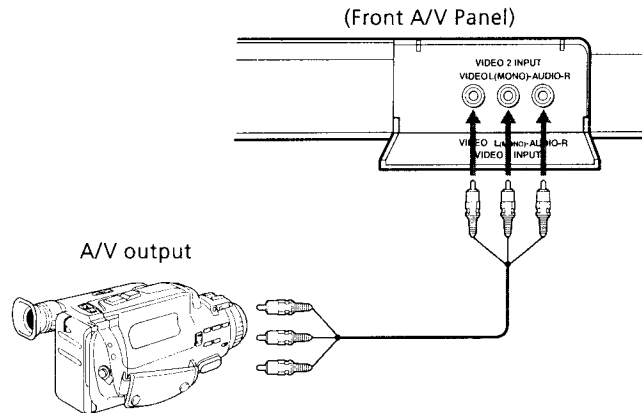

Connecting a DVD Player

Using A/V connectors, connect LINE OUT on your DVD to VIDEO IN on your TV.

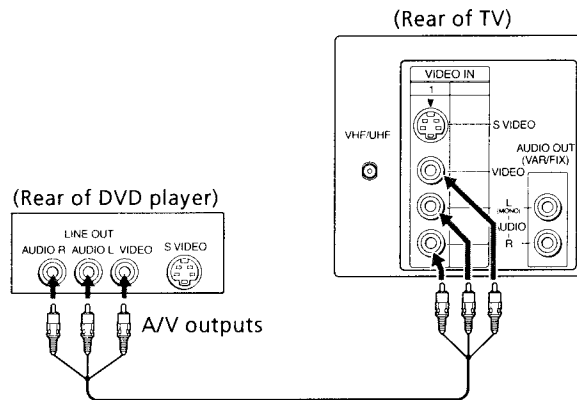

⚠ For optimum picture quality, use S VIDEO instead of the yellow A/V cable. S VIDEO does not provide sound, your audio connectors must still be connected.

Connecting an audio system

Using audio connectors, connect AUDIO OUT on your TV to one of the unused line inputs (e.g. TV, AUX, TAPE 2) on your stereo.

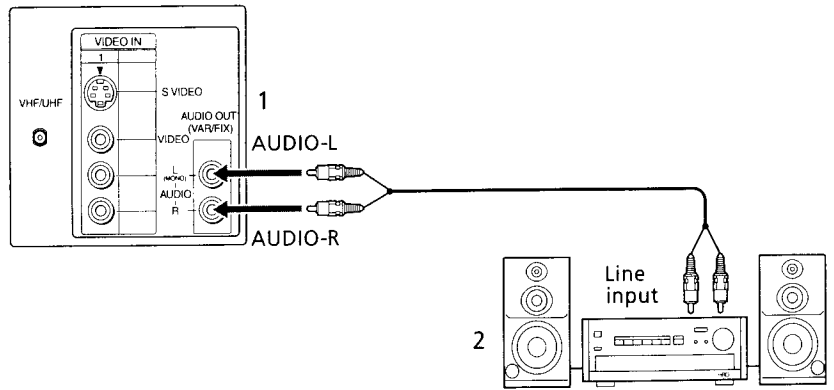



 Set your stereo to the chosen line input. See page 16 for additional audio setup instructions.

Using the Remote Control and Basic Functions

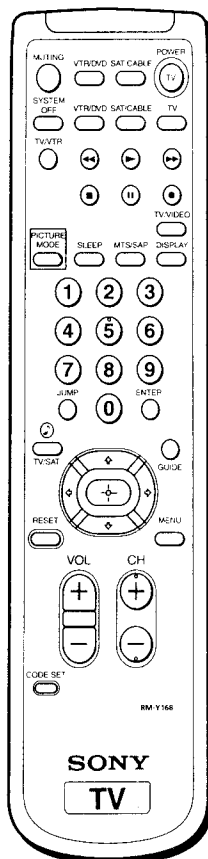
This section shows you how to use more advanced buttons on the remote control and how to use the on-screen menus.



Button	Description
POWER	Press when you want to turn connected equipment on and off.
FUNCTION	Press when you want to control connected equipment with your remote control.
MUTING	Instantly turns off the sound. Press again or press  to restore sound.
SYSTEM OFF	Powers off all Sony equipment at once.
TV/VIDEO	Cycles through available video inputs.
	Moves the cursor in the on-screen menus. Press the arrow buttons to move the cursor, press the center button to select or access an option.
PICTURE MODE	Cycles through the available VIDEO MODE settings.
SLEEP	Turns the TV off automatically in approximately 30, 60 or 90 minutes. Cancel by pressing until SLEEP OFF appears.
MTS/SAP	Cycles through the Multi-channel TV Sound (MTS) options: STEREO, SAP (Second Audio Programming), MONO.
DISPLAY	Press once to show current time, (if set) and channel number. Press again to activate CAPTION VISION settings, if available. To cancel, press again until DISPLAY OFF appears.



JUMP

Cycles through available AUTO VOLUME settings (see page 16).

Alternates back and forth between the last two channels selected with the 0-9 buttons.

GUIDE

Brings up the custom guide of your satellite receiver.

MENU

Displays the on-screen menu. Press again to exit the menu at any time.

RESET

Press to return to factory settings while in the on-screen menu.

CODE SET

Use to program your remote control to operate connected video equipment, (see page 29).

Setting Up the TV Automatically

After you have finished connecting your TV, you will want to run AUTO PROGRAM to set up your channels.

- 1 Press ^{POWER}  to turn on the TV, the initial setup screen appears.

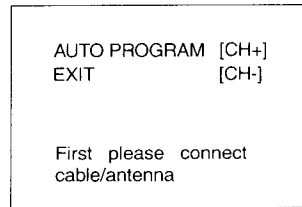

- 2 Press ^{CH}  to AUTO PROGRAM or ^{CH}  to exit.

Quick Start to the Menus

The following settings are available in your on-screen menus:

Menu

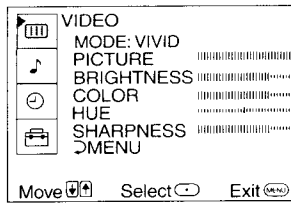

Make adjustments to your picture settings.

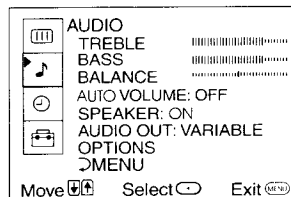

Change your audio settings.

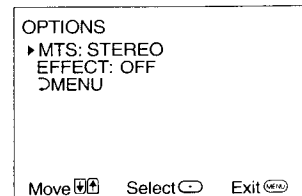

The OPTIONS menu offers customized audio features.

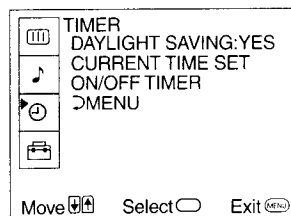

Set the clock on your TV, (CURRENT TIME SET) and program scheduled viewing using the ON/OFF TIMER.

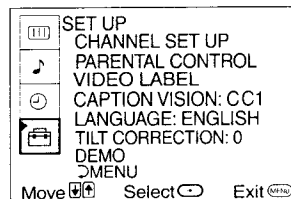

Program your channels.

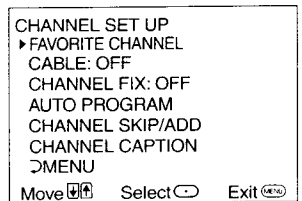





The CHANNEL SET UP provides further options for setting up your channels.

 Menus shown are for KV-24FV10, your menus may not look exactly like those illustrated.

Using the Menus

This chapter shows the options available for setting up and adjusting your TV.

To access a menu

- 1 Press .
- 2 Use the  or  buttons to highlight an option.
- 3 Press  to access the menu.

Using the VIDEO menu

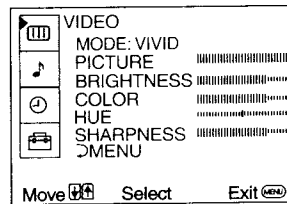

MODE:

Custom picture settings

Item

PICTURE

BRIGHTNESS

COLOR

HUE

SHARPNESS

VIVID: Select for enhanced picture and contrast.

STANDARD: Select for a standard picture.

MOVIE: Select for a darker picture for movie viewing.

Press to

Decrease picture contrast

Darken the picture

Decrease color intensity

Increase the red tones

Soften the picture

Press to

Increase picture contrast

Brighten the picture

Increase color saturation

Increase the green tones

Sharpen the picture

Using the AUDIO 🎵 menu

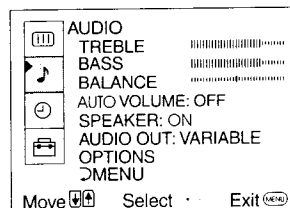

TREBLE	Adjust left or right to adjust higher pitched sound.
BASS	Adjust left or right to adjust low pitched sound.
BALANCE	Adjust left or right to emphasize speaker balance.
AUTO VOLUME <i>Stabilizes volume</i>	ON: Select to stabilize the volume when changing channels. OFF: Select to turn AUTO VOLUME off.
SPEAKER <i>Custom selection of audio output source</i>	ON: Select to listen to the sound from the TV speakers with or without a separate stereo system. OFF: Select to turn off the TV speakers and listen to the TV's sound only through external audio system speakers.
AUDIO OUT	AUDIO OUT can only be set when SPEAKER is set to OFF. VARIABLE: Adjust the volume through your TV. FIXED: Adjust the TV volume through a connected stereo.

Press  for a direct selection of AUTO VOLUME settings.

OPTIONS menu

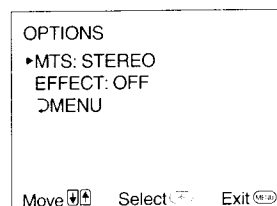

MTS

*Multi-Channel
TV Sound*

EFFECT

*Custom audio
settings*

STEREO: Select when viewing a broadcast in stereo.

SAP: Listen to bilingual broadcast or other Second Audio Programs (SAP).

MONO: Select to reduce noise in areas of poor reception.

SRS: Produces a dynamic three dimensional sound for stereo audio signals, (KV-24FV10 only).

SURROUND: Simulates theater quality sound for stereo programs, (KV-20FV10 only).

SIMULATED: Adds a surround-like effect to mono programs.

 If your TV is set to SAP, all non-SAP programs will be muted. If your TV does not have sound, check your AUDIO settings.

 For direct MTS settings, press the  button on your remote control.

Using the TIMER menu

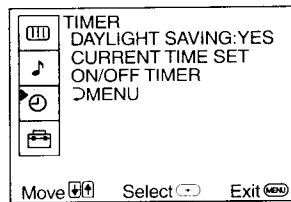











DAYLIGHT SAVING

CURRENT TIME SET

YES: Select in spring to compensate for Daylight Savings.
NO: Select in fall at the end of Daylight Savings.

With the menu open:













- 1 Press .
- 2 Press  or  to cycle through the days, then press .
- 3 Press  or  until the current hour is displayed, then press .
- 4 Press  or  until the current minute is displayed, then press .

ON/OFF TIMER

Scheduled viewing

CURRENT TIME SET must be programmed before the ON/OFF TIMER menu is available.

With the menu open:



- 1 Press .
- 2 Press  or  until the desired day or range of days is displayed, then press .
- 3 Indicate the time that you want the TV to turn on by pressing  or  and the , (for hour and minutes).
- 4 Press  or  to set the duration, up to 6 hours, then press .
- 5 Press  or  to set the channel and press .

 When you perform AUTO PROGRAM, all ON/OFF TIMER settings will be cleared.

 Any loss of power will cause the ON/OFF TIMER settings to be cleared.

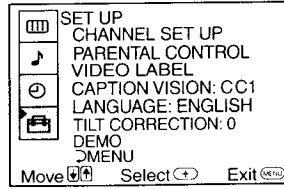
Using the SET UP menu



- PARENTAL CONTROL** The PARENTAL CONTROL feature provides parents several options for programming the TV to block shows based on their rating, (see page 22).
- VIDEO LABEL** With the VIDEO LABEL window open:
Label connected equipment **1** Press \leftarrow or \rightarrow to access the input you want to label and press \rightarrow .
2 Press \leftarrow or \rightarrow to choose a label and press \rightarrow .
- CAPTION VISION** **CC1, 2, 3, 4:** Displays printed dialogue of a program.
Closed-Captioning **TEXT1, 2, 3, 4:** Displays network/station information.
XDS (Extended Data Services): Displays information about the network and current program, if available.
 Press the  button to activate your CAPTION VISION setting.
- LANGUAGE** Display all menus in your language of choice.
1 Point cursor at LANGUAGE and press \rightarrow .
2 Using the \leftarrow or \rightarrow buttons, highlight desired language and press \rightarrow .
- TILT CORRECTION** Press \leftarrow or \rightarrow to correct any tilt of the picture by -5 and +5, press \rightarrow to activate.
- DEMO** Select to run a demonstration of the on-screen menus.

CHANNEL SET UP menu

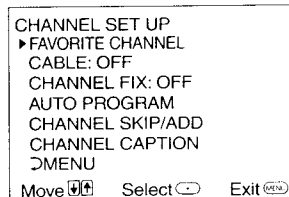
**FAVORITE CHANNEL**

Quick access to favorite channels

With the FAVORITE CHANNEL menu open:

- 1 Use the \uparrow or \downarrow buttons to select AUTO or MANUAL, (selecting AUTO will display the last five channels accessed by the 0 - 9 buttons).
- 2 Select the position (1-5) where you want to program a channel.
- 3 Using the \uparrow or \downarrow buttons, select the desired channel.
- 4 Press ENTER , the TV will change to the channel entered.

To use FAVORITE CHANNEL: Exit all menus and press EXIT . Press \uparrow or \downarrow to move the cursor to the desired channel number and press ENTER .

CABLE

ON: Select if you are receiving cable channels with a CATV cable.

OFF: Select if you are using an antenna.

After changing your CABLE settings, you will need to run AUTO PROGRAM.

CHANNEL FIX

2-6: Select when you want to control all channel selection through a cable box.

VIDEO: Select from available video inputs when you have connected video equipment (e.g. satellite receiver) and you want your TV fixed to it.

FAVORITE CHANNEL cannot be used when CHANNEL FIX is set.

AUTO PROGRAM

Run AUTO PROGRAM whenever setting up your TV. It will cycle through all available channels and program any receivable channels.

CHANNEL SKIP/ADD

Use this feature after you run AUTO PROGRAM to skip unwanted channels or add new ones.

- 1 Use the \uparrow or \downarrow buttons to access the desired channel.
- 2 Press ENTER to SKIP or ADD (only one option will be available).

**CHANNEL
CAPTION**

*Label up to 12
channels with
their call letters*

With the CHANNEL CAPTION window open:

- 1 Press **⏪**, then press **⏮** or **⏭** until you reach the desired channel number.
- 2 Press **⏪** to activate the channel.
- 3 Press **⏮** or **⏭** to display the first call letter or number of the caption and press **⏪** to select it. When finished, press **⏪** to activate.

Using PARENTAL CONTROL

The PARENTAL CONTROL feature is designed to help parents monitor what their children watch on television. This section shows you the different rating systems available and shows you how to set your TV's rating.

Overview of the Ratings

Once you have become familiar with these rating systems, you should be ready to set your TV's rating.

TV RATINGS

The TV ratings are divided into two groups: age-based and content-based.

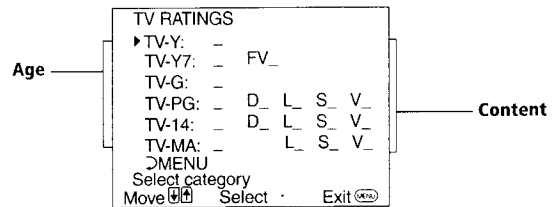

Age	Defined as	Contents	Defined as
TV-Y	All children	FV	Fantasy Violence
TV-Y7	Directed to older children	D	Suggestive dialogue
TV-G	General audience	L	Strong language
TV-PG	Parental Guidance suggested	S	Sexual situations
TV-14	Parents Strongly cautioned	V	Violence
TV-MA	Mature Audience only		

The content ratings will increase depending on the level of the age-based rating. For example, a program with a TV-PG V (Violence) rating may contain moderate violence, while a TV-14 V (Violence) rating may contain intense violence.

MOVIE RATINGS

(U.S. models only)

This system defines the rating levels of movies shown on the big screen and those on prime cable channels.

Rating	Defined as
G	General audience
PG	Parental Guidance suggested
PG-13	Parents strongly cautioned
R	Restricted
NC-17	No one 17 and under admitted
X	No one 17 and under admitted

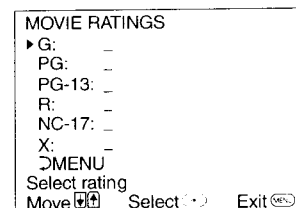

UNRATED

(U.S. models only)

You have the option of blocking TV programs or movies that are not rated.

VIEW ALL	View all unrated programs
BLOCK TV	Block all unrated TV programs
BLOCK MOVIE	Block all unrated movies
BLOCK BOTH	Block all unrated programming

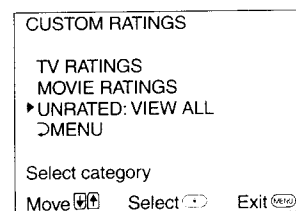

! If you choose to block unrated TV programs, please be aware that the following programs may be blocked: emergency broadcasts, political programs, sports, news, public service announcements, religious programs and weather.

ENGLISH RATINGS

(Canadian models only)

These ratings are for Canadian programs that are broadcast in English.

Rating	Defined as
C	Children
C8+	Children 8 years and older
G	General programming
PG	Parental Guidance
14+	Viewers 14 and older
18+	Adult programming

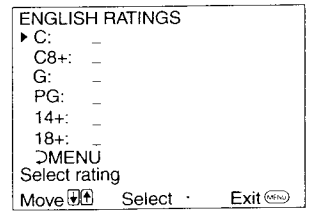

FRENCH RATINGS

(Canadian models only)

These ratings are for Canadian programs that are broadcast in French.

Rating	Defined as
C	General
8 ans+	Not recommended for younger children
13 ans+	Not recommended for children under age 13
16 ans+	Not recommended for ages under 16
18 ans+	This program is restricted to adults

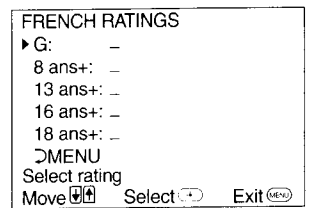

U.S.A RATINGS

(Canadian models only)

For programs from the United States. Please see, "TV RATINGS" on page 22 for information on U.S.A. RATINGS.

Initial access into PARENTAL CONTROL

- 1 In the SET UP menu, point the cursor to PARENTAL CONTROL and press (you will be asked to set a 4-digit password for any future access into PARENTAL CONTROL).

- 2** Press **⏏**, then use the **0-9** buttons to enter a 4-digit password.

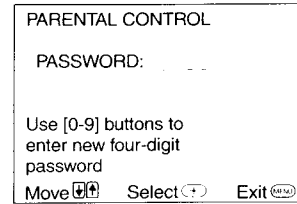

-  Keep this instruction manual in a safe place. In the event that you forget your password, please see page 33.

- 3** Confirm your password by entering it again.

Once your password is set correctly, you will be taken into the PARENTAL CONTROL menu.

Activating PARENTAL LOCK

In order to change the RATING, you will need to set PARENTAL LOCK to ON.

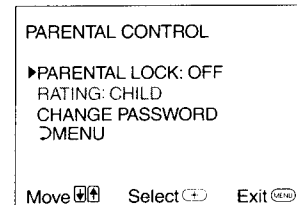

- 1** Point the cursor to PARENTAL LOCK and press **⏏**.
- 2** Using the **⬆** or **⬇** buttons, highlight ON and press **⏏** to activate.

Setting the RATING

If you are not familiar with the Parental Guidelines rating system, you may use one of the following preselected categories to simplify the rating selections: CHILD, YOUTH or YOUNG ADULT.

- 1** Point the cursor to RATING and press **⏏**.

- 2 Using the \uparrow or \downarrow buttons, select the desired rating and press ⏏ .

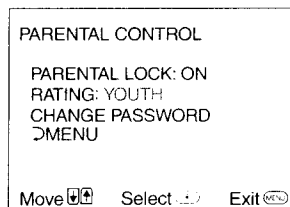

Rating	TV will allow a maximum rating of:
CHILD	TV-Y, TV-G, G (U.S. models only), G (Canadian models only)
YOUTH	TV-PG, PG (U.S. models only), PG (Canadian models only)
YOUNG ADULT	TV-14, PG-13 (U.S. models only), 14+ (Canadian models only)
CUSTOM	Select to set more restrictive ratings.

Using the CUSTOM menu

You should be familiar with the rating systems before attempting to set CUSTOM ratings. Refer to pages 22-24, "Overview of the Ratings," for a description of the available rating systems.

- 1 In the RATING option, use \uparrow or \downarrow to highlight CUSTOM and press ⏏ .
- 2 Using the \uparrow or \downarrow buttons, select the desired rating category and press ⏏ .
- 3 Use \uparrow or \downarrow to select the maximum rating or content and press ⏏ .
- 4 Press \uparrow or \downarrow to block (🔒) or unblock (_) the rating or content and press ⏏ .

 Once you have blocked a rating or content, all higher ratings or contents will be automatically blocked.

Resetting your password

- 1 Use the \uparrow or \downarrow buttons to move the cursor to CHANGE PASSWORD and press ⏏ .
- 2 Follow the directions for, "Initial Access into Parental Control," on pages 24-25, for information on changing your password.

Information for Parents

To view a program that exceeds the TV rating

- Press ⏏ on the remote control, then use the 0 - 9 buttons to enter your password.
-  Entering your password to view a blocked program will temporarily turn PARENTAL LOCK to OFF. To reactivate your PARENTAL LOCK settings, turn the TV off then back on; the TV will return to the settings that you have selected.





1

—

Other Information

Programming the Remote Control

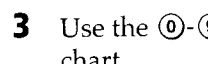
You can use the supplied remote control to operate Sony or non-Sony video equipment.

- 1 Press .
- 2 Press  or  (FUNCTION).
- 3 Use the  buttons to key in the code number from the following chart.
- 4 Press .

VCR codes

Sony	301, 302, 303	JC Penney	309, 305, 304, 330, 314, 336, 337
Admiral (M.Ward)	327	JVC	314, 336, 337, 345, 346, 347
Aiwa	338, 344	Kenwood	314, 336, 332, 337
Audio Dynamic	314, 337	LXI (Sears)	332, 305, 330, 335, 338
Broksonic	319, 317	Magnavox	308, 309, 310
Canon	309, 308	Marantz	314, 336, 337
Citizen	332	Marta	332
Craig	302, 332	Memorex	309, 335
Criterion	315	Minolta	305, 304
Curtis Mathis	304, 338, 309	Mitsubishi/MGA	323, 324, 325, 326
Daewoo	341, 312, 309	Multitech	325, 338, 321
DBX	314, 336, 337	NEC	314, 336, 337
Dimensia	304	Olympic	309, 308
Emerson	319, 320, 316, 317, 318, 341	Optimus	327
Fisher	330, 335	Panasonic	308, 309, 306, 307
Funai	338	Pentax	305, 304
General Electric	329, 304, 309	Philco	308, 309
Go Video	322, 339, 340	Philips	308, 309, 310
Goldstar	332	Pioneer	308
Hitachi	306, 304, 305, 338	Quasar	308, 309, 306
Instant Replay	309, 308	RCA/PROSCAN	304, 305, 308, 309, 311, 312, 313, 310, 329

VCR codes

Realistic	309, 330, 328, 335, 324, 338	Symphonic	338
Sansui	314	Tashiro	332
Samsung	322, 313, 321	Tatung	314, 336, 337
Sanyo	330, 335	Teac	314, 336, 338, 337
Scott	312, 313, 321, 335, 323, 324, 325, 326	Technics	309, 308
Sharp	327, 328	Toshiba	312, 311
Shintom	315	Wards	327, 328, 335, 331, 332
Signature 2000 (M.Ward)	338, 327	Yamaha	314, 330, 336, 337
SV2000	338	Zenith	331
Sylvania	308, 309, 338, 310		

Cable box codes

Hamlin/Regal	222, 223, 224, 225, 226
Jerrold/G. I.	201, 202, 203, 204, 205, 206, 207, 208, 218
Oak	227, 228, 229
Panasonic	219, 220, 221
Pioneer	214, 215
Scientific Atlanta	209, 210, 211
Tocom	216, 217
Zenith	212, 213

Laser Disc Player codes

Sony	701
Panasonic	704, 710
Pioneer	702

Satellite receiver codes

Sony	801 (preset code for remote control)
General Electric	802
Hitachi	805
Hughes	804
Panasonic	803
RCA/PROSCAN	802, 808
Toshiba	806, 807

DVD codes









Sony	751
Panasonic	753
Pioneer	752
RCA	755
Toshiba	754

 If more than one code number is listed, try entering them one by one until you come to the correct code for your equipment.



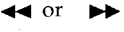





 Whenever you remove the batteries, the code numbers may revert to the factory setting and must be reset.

 In some rare cases, you may not be able to operate your equipment with the supplied remote control. In this case, use the equipment's supplied remote control.



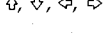

Operating a VCR

Press	To
	Power on the VCR
	Select channels directly
	Change channels
	Play video tape
	Stop
	Search forward or backward
	Pause
	Record
at the same time	
	Change between VCR and TV inputs

Operating a DVD

Press	To
	Power on the DVD
	Select chapters directly
	Search chapters forward or backward
	Play DVD
	Stop
	Pause
	Move the cursor in the menu
	Display the DVD menu

Operating a Laser Disc

Press	To
	Power on the laser disc
	Search chapters forward or backward
	Play disc
	Stop
	Pause

Troubleshooting

If you are having a problem with your TV, try the suggestions below. If the problem persists, contact your nearest Sony dealer.

- | | |
|--|--|
| No picture, no sound | <ul style="list-style-type: none"> <input type="checkbox"/> Make sure the power cord is plugged in. <input type="checkbox"/> If a red light is flashing on the front of your TV for more than a few minutes, call your local service center. <input type="checkbox"/> Check your PARENTAL CONTROL settings, (pages 25-26). <input type="checkbox"/> Check the TV/VIDEO settings: when watching TV, set to TV; when watching video equipment, set to VIDEO (page 15). <input type="checkbox"/> Make sure the batteries have been inserted correctly into the remote control. <input type="checkbox"/> Try another channel, it could be station trouble. |
| Poor or no picture, good sound | <ul style="list-style-type: none"> <input type="checkbox"/> Adjust PICTURE in the VIDEO menu (page 15). <input type="checkbox"/> Adjust BRIGHTNESS in the VIDEO menu (page 15). <input type="checkbox"/> Check the antenna and/or cable connections (page 3). |
| Good picture, no sound | <ul style="list-style-type: none"> <input type="checkbox"/> Press MUTING so that MUTING disappears from the screen (page 11). <input type="checkbox"/> Check your AUDIO settings. Your TV may be set to SAP (page 16). |
| No color | <ul style="list-style-type: none"> <input type="checkbox"/> Adjust COLOR in the VIDEO menu (page 15). |
| Only snow appears on the screen | <ul style="list-style-type: none"> <input type="checkbox"/> Check the CABLE setting in the SET UP menu (page 20). <input type="checkbox"/> Check the antenna and/or cable connections (page 3). <input type="checkbox"/> Make sure the channel selected is currently broadcasting. |
| Dotted lines or stripes | <ul style="list-style-type: none"> <input type="checkbox"/> Adjust the antenna. <input type="checkbox"/> Move the TV away from other electronic equipment. Some electronic equipment can create electrical noise, which can interfere with TV reception. |
| Double images or ghosts | <ul style="list-style-type: none"> <input type="checkbox"/> Check your outdoor antenna or call your cable service. |
| Cannot receive higher number channels (UHF) when using an antenna | <ul style="list-style-type: none"> <input type="checkbox"/> Make sure CABLE is set to OFF in the SET UP menu (page 20). <input type="checkbox"/> Use AUTO PROGRAM to add channels that are not presently in the memory (page 20). |

**Cable stations
don't seem to
work**

- Make sure CABLE is set to ON in the SET UP menu (page 20).
- Use AUTO PROGRAM to add channels that are not presently in the memory (page 20).

**Remote
Control does
not operate**

- Batteries could be weak. Replace them (page 2).
- Move the TV 3-4 feet away from fluorescent lights.

**The TV needs
to be cleaned**

- Clean the TV with a soft dry cloth. Never use strong solvents such as thinner or benzine, which might damage the finish of the cabinet.

**Lost password
for PARENTAL
CONTROL**

- In the password screen, enter the following master password: 4357. After using the master password, you must create a new password.

If, after reading these operating instructions, you have additional questions related to the use of your Sony television, please call our Direct Response Center at 1-800-222-SONY (7669) (U.S. residents only). (416) 499-SONY (7669) (Canadian residents only).

Specifications

For all models (except as noted)

Television system	American TV standard / NTSC
Channel coverage	VHF: 2-13 / UHF: 14-69 / CATV: 1-125
Antenna	75-ohm external antenna terminal for VHF / UHF
Picture tube	FD Trinitron®
Power requirements	120 V, 60 Hz
Supplied Accessories	Size AA (R6) batteries (2) Remote Control RM-Y168
Optional Accessories	Antenna dipole Connecting cables VMC-810S / 820S, VMC-720M, YC-15V / 30V, RK74A U / V mixer EAC-66

KV-20FV10

Screen size	Visible screen size: 20 inch measured diagonally Actual tube size: 21 inch measured diagonally
Inputs/outputs	2 video, 2 audio 1 S VIDEO 1 AUDIO OUT 1 headphone jack
Speaker output	5 W x 2
Power Consumption	125 W when in use 1 W in standby
Dimensions (W/H/D)	562 x 466 x 503 mm (22 1/8 x 18 3/8 x 19 3/4 in.)
Mass	27 kg (59 lbs.)

KV-24FV10

Screen size	Visible screen size: 24 inch measured diagonally Actual tube size: 25 inch measured diagonally
Inputs/outputs	2 video, 2 audio 1 S VIDEO 1 AUDIO OUT 1 headphone jack
Speaker output	10 W x 2
Power Consumption	150 W when in use 1 W in standby
Dimensions (W/H/D)	652 x 524.3 x 467.3 mm (25 3/4 x 20 11/16 x 18 7/16 in.)
Mass	37 kg (87 lbs. 9oz)

Design and specifications are subject to change without notice.

Index

A

AUDIO  menu 16
 AUTO PROGRAM 20
 AUTO VOLUME CONTROL 16

B

Battery Installation 2
 BRIGHTNESS 15

C

Cable box codes 30
 CAPTION VISION 19
 CHANNEL CAPTION 21
 CHANNEL FIX 20
 CHANGE PASSWORD 27
 CHANNEL SET UP 20
 COLOR 15
 Code numbers
 Cable box 30
 Satellite Receiver 30
 DVD 30
 Laser Disc Player 30
 VCR 29
 Connections
 Connecting a Camcorder 9
 Connecting a DVD player 9
 Connecting and audio system 10
 TV and Cable Box 5
 TV and VCR 4
 TV and Satellite Receiver 7
 TV, Satellite Receiver and VCR 8
 TV, VCR, and Cable box 6
 CURRENT TIME SET 18

D

DAYLIGHT SAVING 18
 DEMO 19
 DVD codes 30

E

ENGLISH RATINGS 24

F

FAVORITE CHANNEL 1, 20
 FRENCH RATINGS 24





H

HUE 15

L

LANGUAGE 19
 Laser Disc Player codes 30

M

Menus
 AUDIO  16
 SET UP  19
 TIMER  18
 VIDEO  15
 MOVIE RATING 23
 MTS 17
 MONO 17
 SAP 17
 STEREO 17

O

ON/OFF TIMER 1, 18

P

PARENTAL CONTROL 22
 Password
 Entering 24
 Lost 33
 PICTURE 15

R

RATINGS
 ENGLISH 24
 FRENCH 24
 MOVIE 23
 TV 22
 UNRATED 23
 U.S.A. 24
 Remote Control 11

S

SET UP  menu 19

SHARPNESS 15
Specifications 34

T

TIMER menu 18
Troubleshooting 32
TV Features 1
TV RATING 22
TILT CORRECTION 19

U

U.S.A. RATINGS 24
UNRATED 23

V

VCR codes 29
VIDEO menu 15
VIDEO MODE 15
 VIVID 15
 STANDARD 15
 MOVIE 15
VIDEO LABEL 19

