

SONY

TRINITRON® COLOR TV **BASIC SCHEMATIC DIAGRAM**

KV-2165MTJ/RM-827S

Chassis No. SCC-F21J

NOTE

THIS SCHEMATIC DIAGRAM IS FOR USE BY YOUR SERVICE
TECHNICIAN.
KEEP THIS DIAGRAM HANDY FOR FUTURE REFERENCE.

4-037-875-01

Sony Corporation

© 1992

Printed in Japan

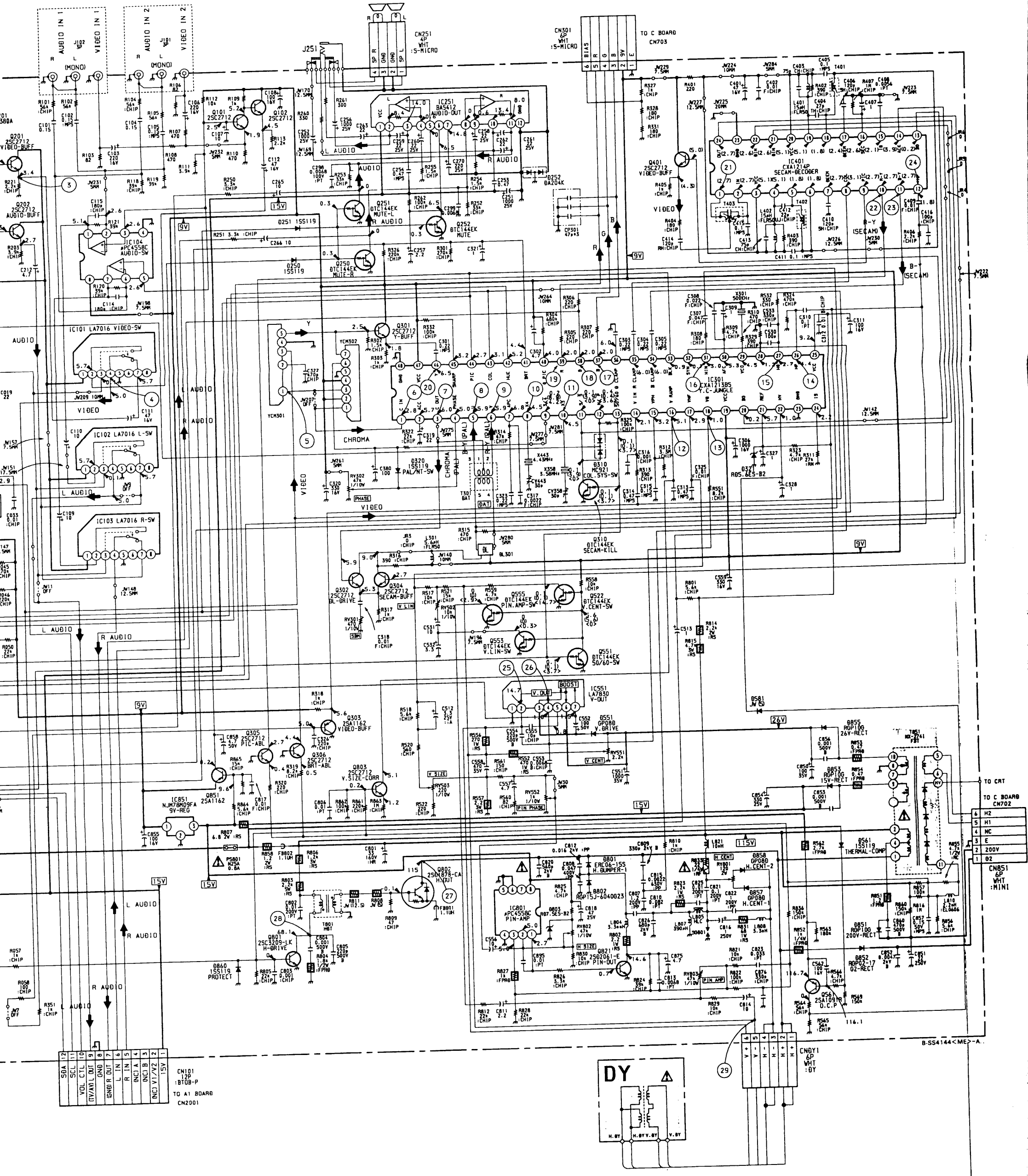

SBA	12
SCL	11
VOL CTL	10
TV/AV L OUT	9
GND	8
GND R OUT	7
L IN	6
R IN	5
INC A	4
INC B	3
INC V1/V2	2
15V	1

CN101
 12P
 BT08-P
 TO A1 BOARD
 CN2001

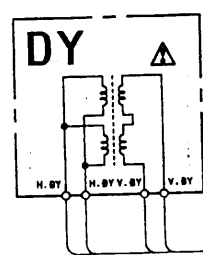

6	HZ
5	M1
4	MC
3	E
2	200V
1	B2

TO CRT
 TO C BOARD
 CN702

CN851
 6P
 WHT
 :DY

B-SS4144<ME>-A

• A BOARD WAVEFORMS

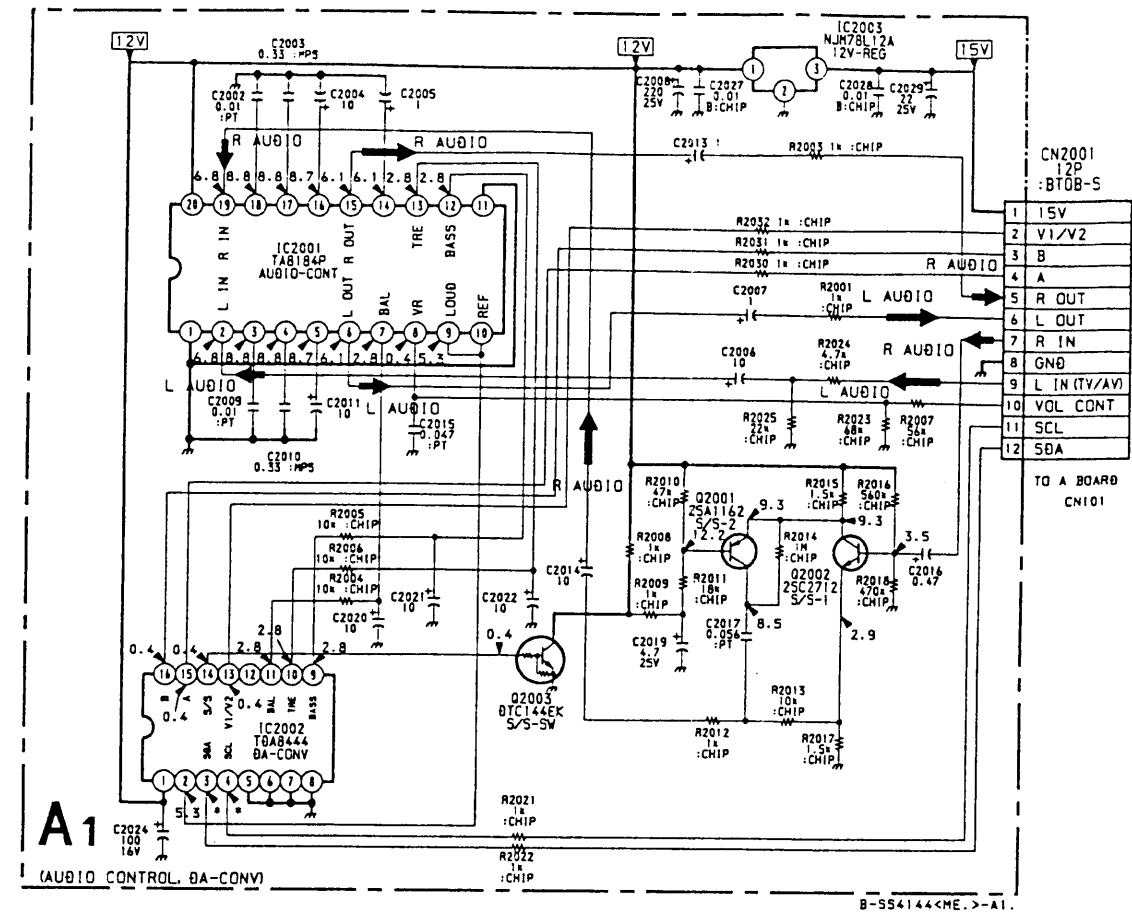
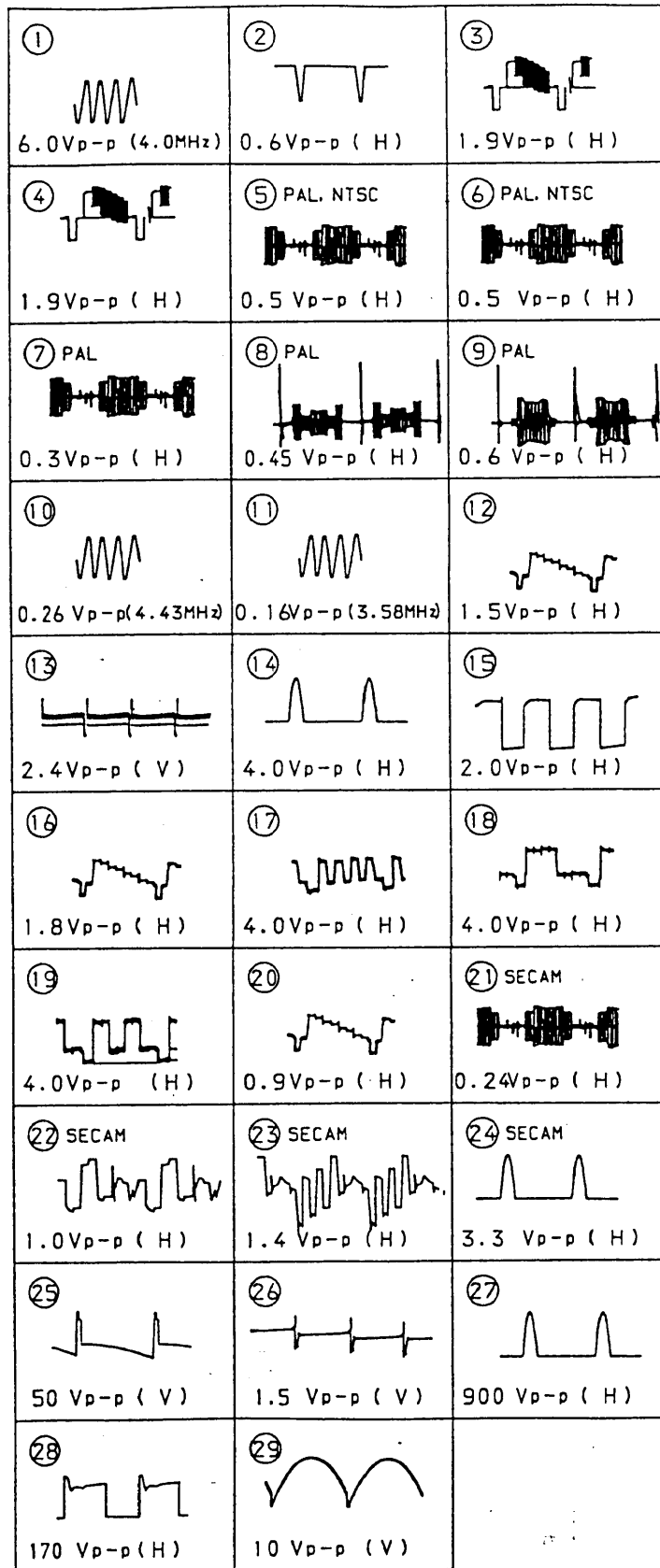

A1 [AUDIO CONTROL, DA-CONV]

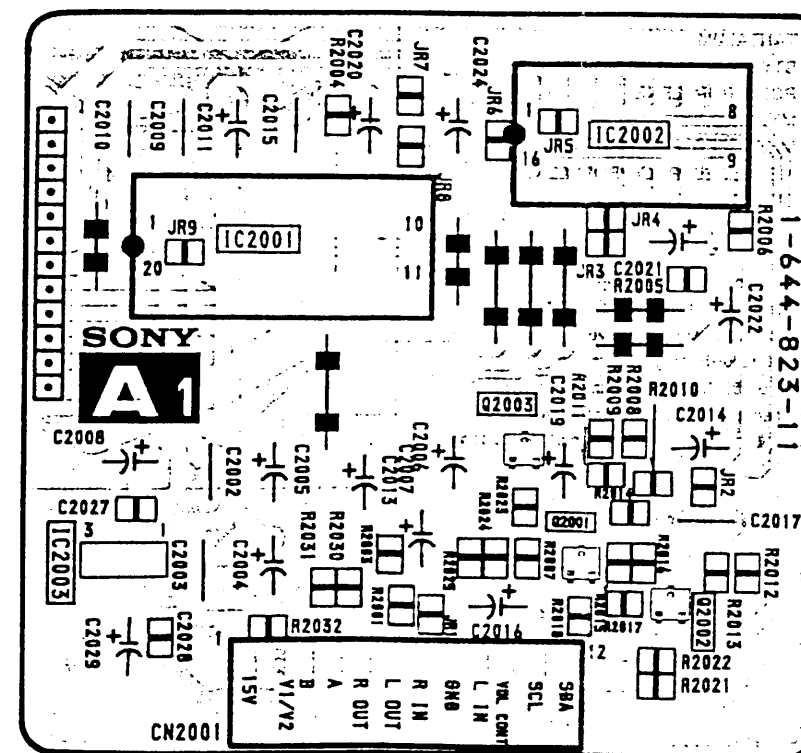

• C BOARD WAVEFORMS

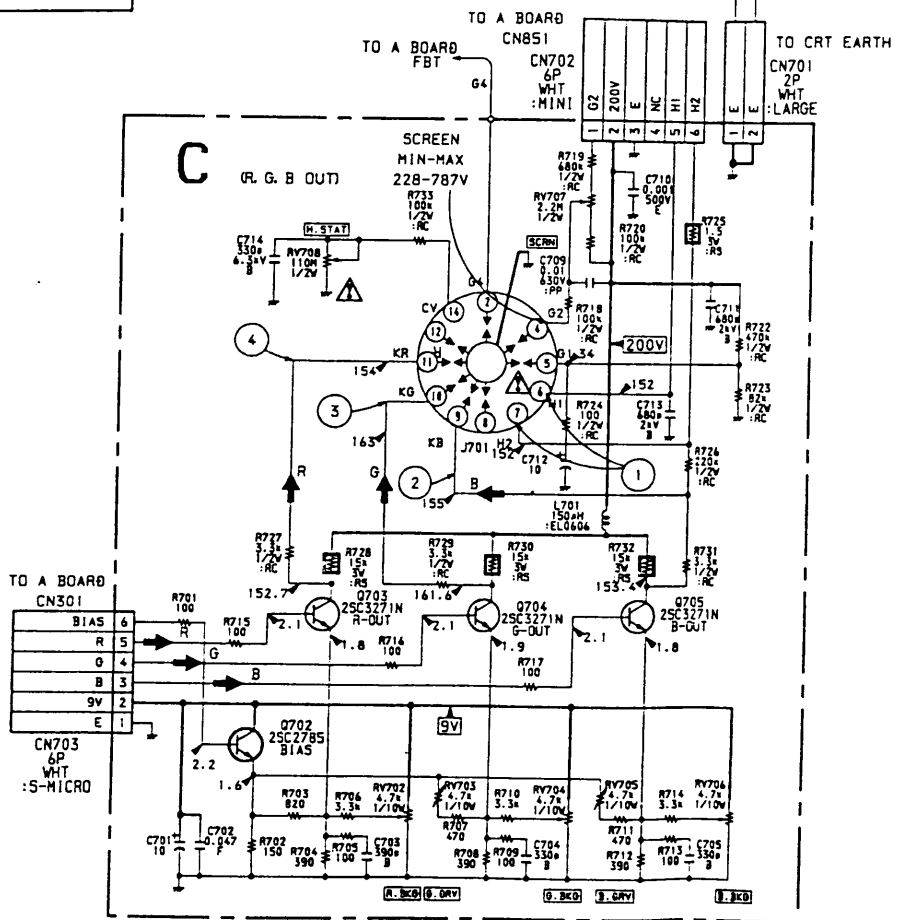
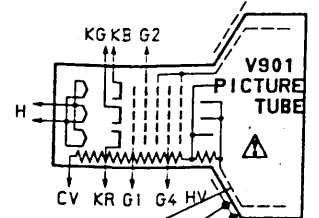
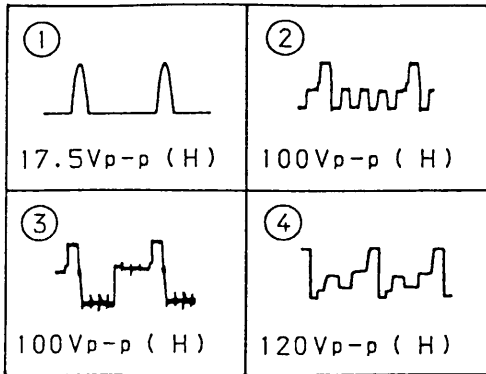

IC		DIODE		VARIABLE RESISTOR	
IC001	C-8	D001	C-9	RV301	B-6
IC002	G-10	D002	C-8	RV302	B-3
IC003	D-8	D003	C-9	RV502	E-5
IC004	B-7	D004	C-9	RV503	G-5
IC005	D-7	D005	F-10	RV551	G-4
IC101	B-1	D006	D-8	RV552	F-4
IC102	A-7	D007	E-10	RV801	E-3
IC103	A-7	D008	D-10	RV802	E-5
IC104	A-2	D009	E-10	RV803	E-5
IC251	A-9	D010	C-10		
IC301	C-5	D011	C-10		
IC401	A-3	D012	C-9		
IC551	G-5	D014	C-9		
IC601	G-6	D016	C-7		
IC602	E-6	D151	C-8	DELAY LINE	
IC603	G-5	D155	A-2	DL301 B-4	
IC801	E-4	D250	B-9		
		D251	A-8		
		D252	B-9		
TRANSISTOR		D310	B-5	IF BLOCK	
Q001	B-8	D320	B-4	IF201 B-2	
Q002	B-3	D321	B-6		
Q003	C-7	D551	G-4		
Q004	B-9	D561	E-6	TUNER	
Q005	D-7	D601	C-9	TU151 C-1	
Q006	C-7	D602	G-7		
Q007	B-8	D603	F-6		
Q101	A-1	D604	E-6		
Q102	A-1	D605	E-7	CRYSTAL	
Q151	C-3	D607	G-6	X301 C-5	
Q152	C-2	D608	E-6	X358 B-5	
Q153	D-3	D801	E-1	X443 B-4	
Q154	D-3	D802	D-6		
Q201	B-1	D803	E-4		
Q202	A-2	D851	G-3		
Q250	B-9	D852	F-3		
Q251	B-8	D853	G-3		
Q252	B-8	D855	G-3		
Q301	C-4	D857	E-3		
Q302	B-6	D858	E-3		
Q303	C-3	D860	D-2		
Q304	B-6				
Q305	C-4				
Q306	C-4				
Q310	B-5				
Q401	A-4				
Q522	E-5				
Q551	D-6				
Q553	E-5				
Q555	E-5				
Q561	D-6				
Q601	G-6				
Q603	G-6				
Q801	D-2				
Q802	E-1				
Q803	B-5				
Q821	D-4				
Q851	F-5				

SEMICONDUCTORS

BA5412
TDA8444

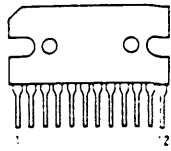

CXA1213BS

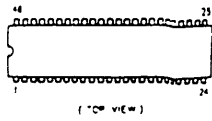

CXA1214P

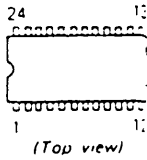

HZT33-02
 μ PC574J



LA7016

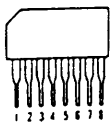

LA7830

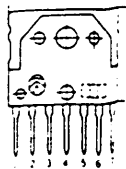

L78LR05D-MA

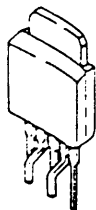

M34302M8-611SP

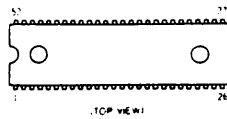

NJM78L12A

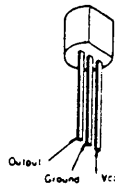

NJM78M09FA



STR-S6307

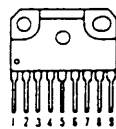

ST24C02AB1
 μ PC4558C

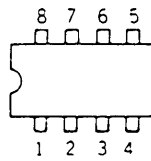

(Top view)

TA8184P

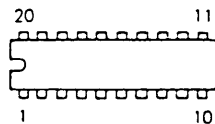

(Top view)

PC111LS

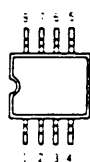

(TOP VIEW)

DTA114EK
DTC144EK
2SA1162-YG
2SC2712-YG

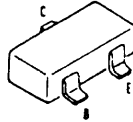

2SA1091-O
2S1091R

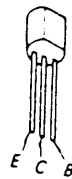

2SC2785-HFE



2SC3271-N

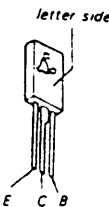

2SD1878-CA

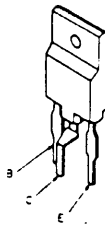

2SD2012
2SD2061-E



DA204U

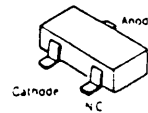

ERC06-15S
RGP10G
RU-3AM
R2M

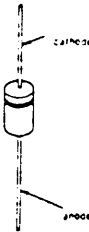

EGP20G
RGP02-17
RGP15J

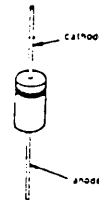

GP08D
U05G

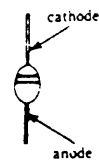

MC921



RBV-406H-01

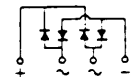
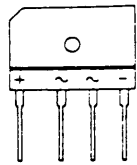

RD5.1ES-B2
RD5.6ES-B2
RD7.5ES-B2
1SS119

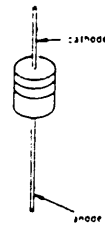

SEL1222R-C

