

VARIABLE CAPACITANCE DIODE

FEATURES

- Excellent Linearity (CV Curve)
- Large Capacitance Ratio (A = 2.00 minimum) with Very Low Series Resistance
- Two Diodes in a Miniature Package (SOT23-3)
- Very Small Capacitance Deviation at Tape/Reel

APPLICATIONS

- FM Radio
- Voltage Controlled Oscillator

DESCRIPTION

The KV1720S is specially made to be used as a tuning element in radio cassettes, stereos, car radios, and other consumer radios.

The KV1720S minimizes cross modulation, allowing good signal-to-noise ratio in the overall design.

The KV1720S is available in the miniature SOT23-3 surface mount package.

CLASSIFICATION

(Unit: pF)

C		RANK			
		1	2	3	4
C ₂	MIN	41.17	42.33	43.52	44.75
	MAX	42.76	43.96	45.20	46.48

Note: Rank is determined after testing and marked on the reel. All the diodes on a reel have the same rank, but rank can not be specified when ordering.

ORDERING INFORMATION

KV1720S□□

Tape/Reel Code

TAPE/REEL CODE
TL: Tape Left

KV1720R

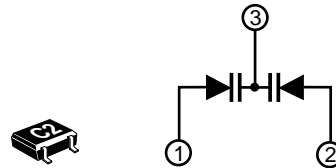

KV1720S

ABSOLUTE MAXIMUM RATINGS

Reverse Voltage 18V Storage Temperature Range -55 to +150 °C
Forward Current 50 mA Operating Temperature Range -55 to +85 °C
Power Dissipation 100 mW Lead Soldering Temperature (10 s) 235 °C

ELECTRICAL CHARACTERISTICS

Test conditions: $T_A = 25\text{ °C}$

SYMBOL	PARAMETER	TEST CONDITIONS	MIN	TYP	MAX	UNITS
V_{REV}	Reverse Voltage	$I_{REV} = 10\ \mu\text{A}$	12			V
I_{REV}	Reverse Current	$V_{REV} = 10\ \text{V}$			10	nA
C_2	Diode Capacitance 2	$V_{REV} = 2.0\ \text{V}, f = 1\ \text{MHz}$	41.17		46.48	pF
C_8	Diode Capacitance 8	$V_{REV} = 8.0\ \text{V}, f = 1\ \text{MHz}$	16.00		21.34	pF
R_S	Series Resistance	$V_{REV} = 1.0\ \text{V}, f = 100\ \text{MHz}$			0.3	Ω
A	Capacitance Ratio	C_2 / C_8	2.00		2.60	

Note 1: Diode Capacitance measured with HP 4279A or equivalent instruments (at OSC level 20 mVrms, $\pm 5\ \text{mVrms}$).

Note 2: Series Resistance measured with HP 4291B or equivalent instruments.

Note 3: The tolerance of two adjacent parts on a reel is within 3% at C2, C5, and C8.

Note 4: The value of capacitance is the average of 2 back to back type diodes.

TYPICAL PERFORMANCE CHARACTERISTICS

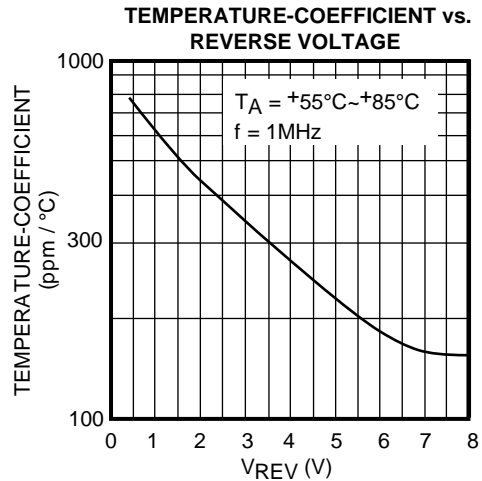
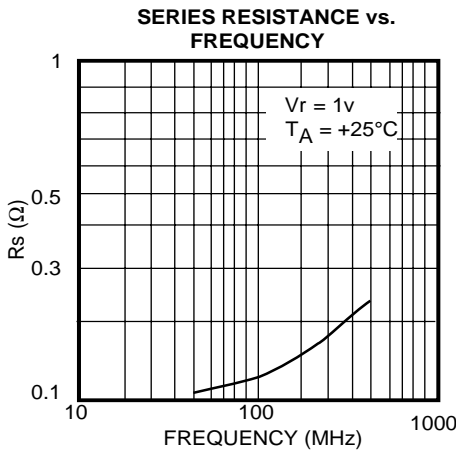
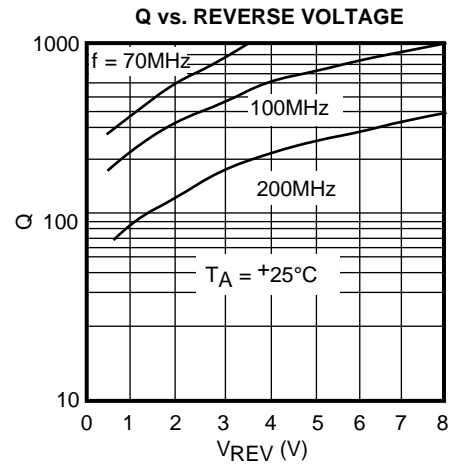
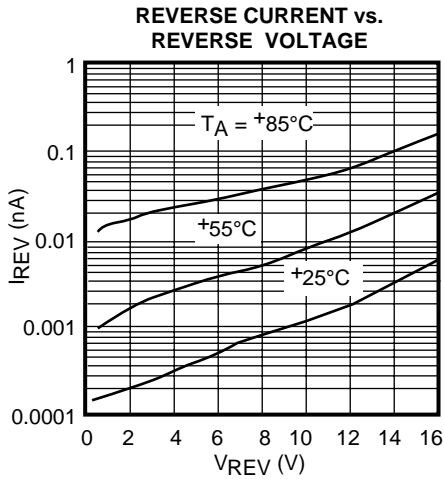
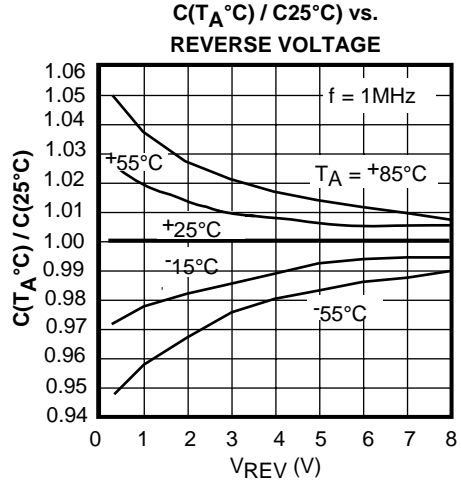
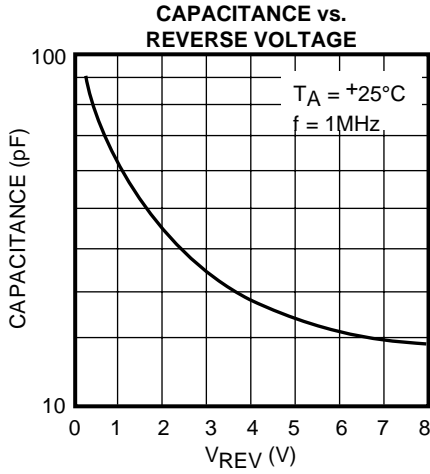

PACKAGE OUTLINE

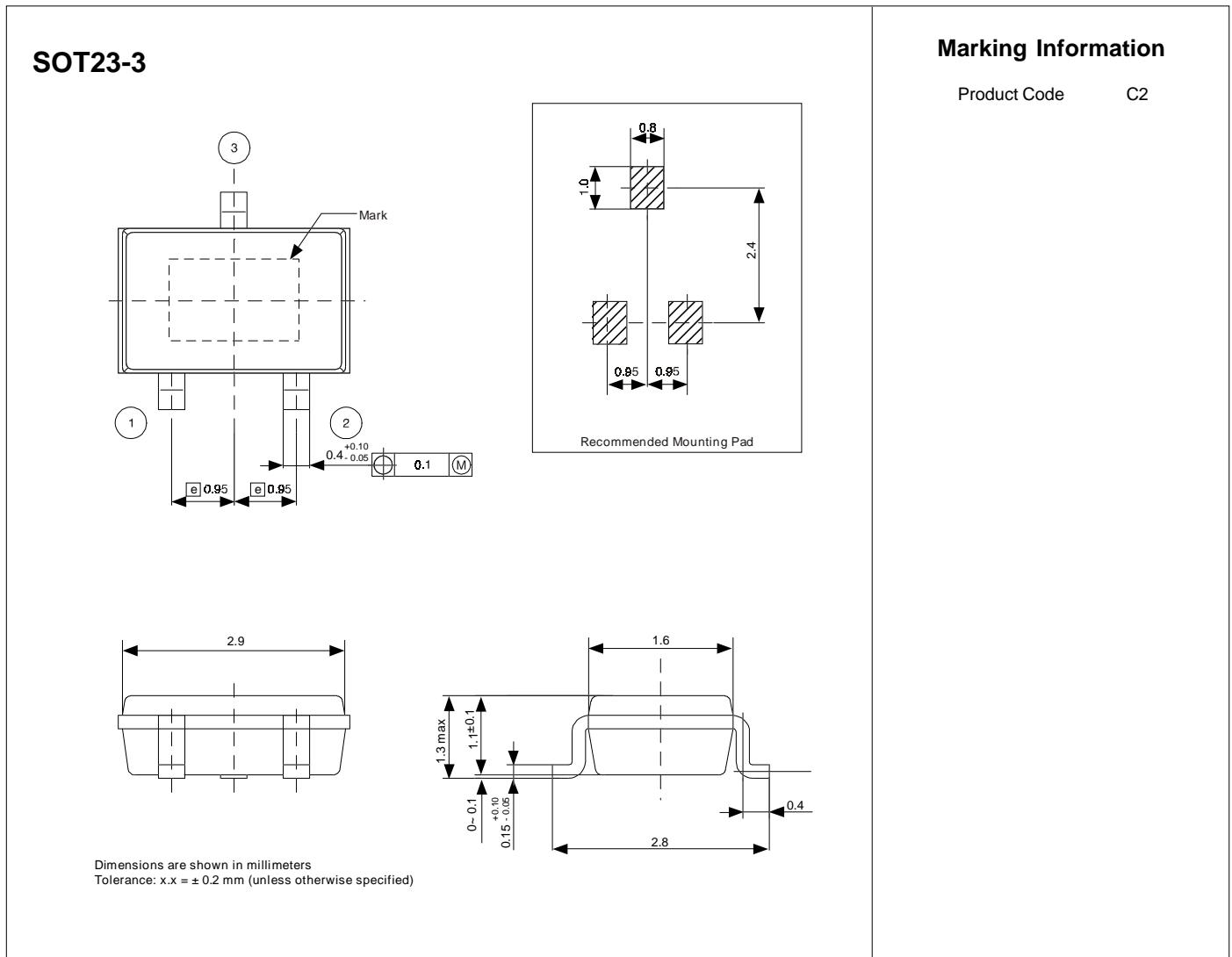

Toko America, Inc. Headquarters
 1250 Feehanville Drive, Mount Prospect, Illinois 60056
 Tel: (847) 297-0070 Fax: (847) 699-7864

TOKO AMERICA REGIONAL OFFICES

Midwest Regional Office
 Toko America, Inc.
 1250 Feehanville Drive
 Mount Prospect, IL 60056
 Tel: (847) 297-0070
 Fax: (847) 699-7864

Western Regional Office
 Toko America, Inc.
 2480 North First Street, Suite 260
 San Jose, CA 95131
 Tel: (408) 432-8281
 Fax: (408) 943-9790

Semiconductor Technical Support
 Toko Design Center
 4755 Forge Road
 Colorado Springs, CO 80907
 Tel: (719) 528-2200
 Fax: (719) 528-2375

Visit our Internet site at <http://www.tokoam.com>

The information furnished by TOKO, Inc. is believed to be accurate and reliable. However, TOKO reserves the right to make changes or improvements in the design, specification or manufacture of its products without further notice. TOKO does not assume any liability arising from the application or use of any product or circuit described herein, nor for any infringements of patents or other rights of third parties which may result from the use of its products. No license is granted by implication or otherwise under any patent or patent rights of TOKO, Inc.