

# 深圳市凯为数码科技有限公司

Shenzhen Canway Digi-Tech Co.,Ltd

## SPECIFICATION

MODEL: KW-3A-V59S-A001

Rev: 0.1

Part Number:

Published Date:

Approved by Canway		
Prepared by 编写	Checked by 审核	Approved by 批准

Please return us one original approved by you with your signatures.

客户承认签章后敬请寄回正本一份

Approved by customer		
Comments 确认意见	Approved by 批准签字	Company's seal 盖章
Customer's Name:		

## Content 目录

1.General Description( 概述) .....	3
2.Function Layout(产品外观图) .....	3
3.Features( 特性说明).....	5
3.1 Power Supply Parts Overview( 电源特性说明).....	5
3.2 TV Solution Control Parts Features( TV解码部分特性说明).....	5
4.Interface Definition( 接口定义) .....	8
5.Safety( 安规) .....	12
6.EMC(电磁兼容性) .....	12
6.1 EMI ( 电磁干扰) .....	12
6.2 EMS ( 电磁干扰) .....	12
7.Mechanical Dimension( 结构尺寸图) .....	13
8.IR & Key Reference Schematics (IR & Key 原理图).....	13
9.Configuration & General Precautions( 使用环境和注意事项) .....	14
10.Mount precautions ( 组装注意事项) .....	15
11.Packing,Shipping & Storing ( 组装注意事项) .....	15
Appendix: Another Structure .....	16

**REVISION HISTORY**

<b>Rev</b>	<b>DATE</b>	<b>PAGE</b>	<b>DESCRIPTION</b>	<b>AUTHOR</b>
0.1	13.06.24	All	First issued	Danny Xu

All right reserved. Please refer to the last sample if the specification has change

## 1. GENERAL DESCRIPTION (概述)

**3A-V59S-A** is an integration board of power supply, LED driver and TV solution board.

**3A-V59S-A** 是一款电源、LED驱动、TV方案一体的电视板。

**3A-V59S-A** is an analog TV control board, which is suitable for Asia-Pacific and middle-East market. 该款TV方案的模拟电视解决方案，适用于国内及亚太、中东市场。

**3A-V59S-A**'s USB slot can be used for updating software and playing multi-media, such as MP3 and JPEG. 该款方案的USB 接口可用于软件升级和多媒体播放。

**3A-V59S-A**'s power part is an energy-efficient ultra thin DC-line switching power supply unit, with max 71W/115V AC input, 60 watts multi-output. It fits to 22" to 32" LED backlight TFT panel.

该款方案的电源部分是高效率开关电源，功率最大输入为71W/115VAC，总输出功率为60W，支持22到32寸LED 背光的TFT屏。

## 2. FUNCTION LAYOUT (产品外观)

**NOTE:** The optional connectors and terminals are marked with "\*".

### FRONT VIEW OF 3A-V59S-A001 (前视图)

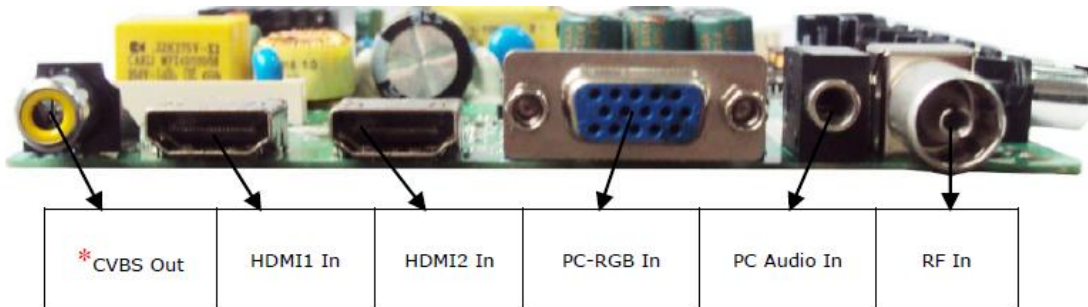

### SIDE VIEW OF 3A-V59S-A001 (侧视图)

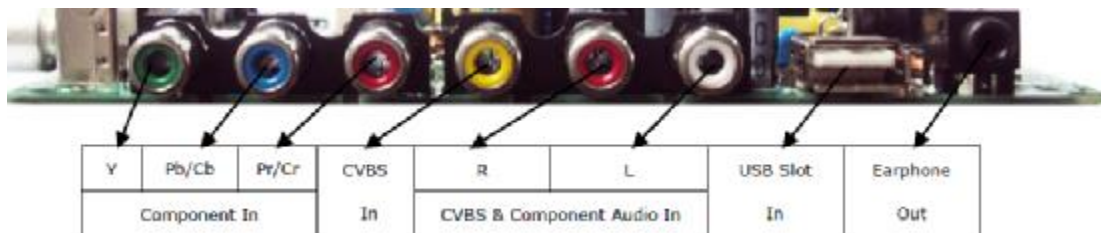

**TOPVIEW OF 3A-V59S-A001 (正视图)**

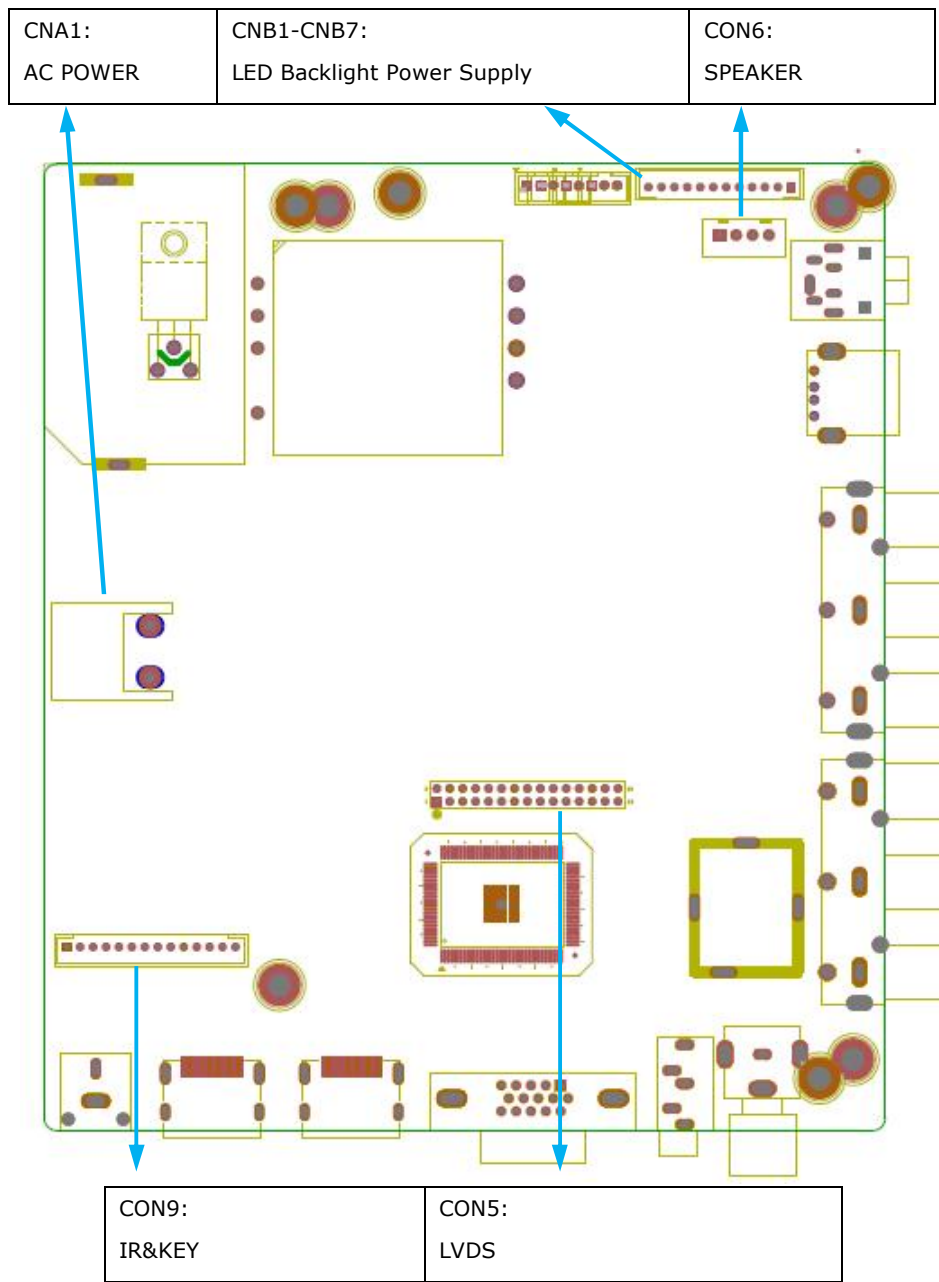

### 3. FEATURES 特性说明

#### 3.1 Power Supply Parts Overview(电性能指标)

##### 3.1.1 Input Electrical Characteristics Overview (输入特性)

<b>Input voltage range</b> 输入电压范围	90Vac-264Vac
<b>Normal voltage range</b> 标准输入	100Vac-240Vac
<b>Frequency range</b> 频率范围	50Hz/60Hz
<b>Max input AC current</b> 满载输入电流	100Vac/3.0A Max.
<b>Inrush current (cold start)</b> 浪涌电流(冷机)	50A/115Vac; 100A/230Vac
<b>Efficiency (full load)</b> 效率	≥75% at 230Vac
<b>Harmonic current</b> 谐波电流	Meet GB17625.1-1998/IEC61000-3-2 class D
<b>PFC</b> 功率因素	≥0.90 at 264Vac Input
<b>Leakage Current</b> 泄漏电流	≤0.75mA/230Vac
<b>Standby Power Consumption</b> 待机功耗	≤0.5W/230Vac
<b>Input Fuse</b> 输入保险额定值	T3.15AL/250Vac

##### 3.1.2 LED Driver Electrical Characteristics Overview (LED 驱动特性)

Parameter 参数	Symbol 符号	MIN 最小值	Typical 典型值	MAX 最大值	Unit 单位	Remark 备注
<b>LED VOLTAGE</b>	VL	-	52.5		Vrms	RL= LED panel
<b>LED CURRENT</b>	IL		600		mA	RL= LED panel

#### 3.2 TV Solution Control Parts Features (主方案特性说明)

##### 3.2.1 Main Features Overview (主要特性)

<b>CHIPSET (主芯片)</b>	TSUMV59XUS (No TELETEXT and NICAM 无图文丽音)		
	TSUMV59XES (With TELETEXT and NICAM 无图文丽音)		
<b>MARKET (目标市场)</b>	Asia-Pacific, Middle-East, South-America 亚太, 中东, 南美		
<b>OSD LANGUAGE (OSD语言)</b>	English, Chinese, Multi-Language, 英文, 中文, 多国语言		
<b>PANEL (面板)</b>	Panel Type(类型)	TFT LCD With LED Backlight (LED背光屏)	
	Interface(接口)	Dual/Single LVDS interface (单/双通道LVDS)	
	Resolution (分辨率)	Up to 1920x1200	
<b>TV INPUT (电视信号输入)</b>	ATV	Tuner Receiving Range (接收范围)	48.25MHz ~ 863.25MHz
		Input Impedance	75Ω

		(输入阻抗)	
		Video System (视频制式)	PAL, NTSC, SECAM
		Sound System (声音制式)	BG, DK, I, M,N NICAM A2 (TSUMV59XES)
		TELETEXT (图文)	1000pages (only@TSUMV59XES)
		Max. Storage Channels (最大储存频道数)	199CH
		Color Killer Level (彩色信号截止幅度)	≦ 30dBuV
		NICAM Sensitivity (丽音灵敏度)	≦ 45dBuV
	<b>VIDEO INPUT</b> (视频信号输入)	PC-RGB	Format (格式)
CVBS		Video System (视频制式)	PAL/NTSC/SECAM
		Video Level (信号幅度)	1.0 Vp-p ±5%
Component		480i, 480p, 576i, 576p, 720p, 1080i, 1080p	
HDMI		480i, 480p, 576i, 576p, 720p, 1080i, 1080p	
<b>AUDIO INPUT</b> (音频信号输入)	PC-Audio	Earphone Input	0.2 ~ 2.0Vrms
	CVBS	L/R RCA input	0.2 ~ 2.0Vrms
	Component		
<b>VIDEO OUTPUT</b> (视频信号输入)	CVBS	Video System (视频制式)	PAL/NTSC/SECAM
		Video Level (信号幅度)	1.0 Vp-p ±5%
<b>AUDIO OUTPUT</b> (音频输出)	AV OUT	L/R RCA output	0.2 ~ 2.0Vrms
	Speaker	Frequency response(频率响应)	120Hz-15KHz @±3dB (1KHz 0dB reference signal 参考信号为1KHz 0dB)
		Max Output Power (最大输出功率)	2x8W (8Ω) THD+N<10%@1KHz (Audio input:0.5Vrms)
<b>POWER TO TCON</b> (屏TCON供电)	To Panel (驱屏电压)	5V / 12V Optional 通过跳线选择5V或12V	
<b>COMB FILTER</b> (梳状滤波器)	3D		
<b>DE-INTERLACE</b> (隔逐行转换)	3D		
<b>KEY FUNCTION</b> (按键功能)	MENU, CH+, CH-, VOL+, VOL-, INPUT, POWER 菜单, 频道+, 频道-, 音量+, 音量-, 信号源, 电源		
<b>Note:</b> Licenses involved in specifications above are supposed to be obtained by customers themselves. 注意: 以上规格涉及License部分需要客户自己根据需要获取。			

## 3.1.2 USB Multi-Media Playback Format (USB 多媒体播放支持格式列表)

Media 媒体	File Ext. 扩展名	Codec 编解码		Remarks 备注		
		Video 视频	Audio 音频			
Movie	*.avi	MJPEG	AA3 , PCM, MP2,MP3, WMA	<b>Max Resolution &amp; Frame Rate:</b> 640×480@30 fps, <b>Max Data Rate:</b> 10 Mbps		
		Xvid,MPEG-2, MPEG-4,H.264		<b>Max Resolution &amp; Frame Rate:</b> 1920×1080@30 fps, <b>Max Data Rate:</b> 20 Mbps		
	*.mp4	MPEG-2,MPEG-4, H.264				
	*.ts /*.*trp	MPEG-2,H.264				
	*.mkv *.mov	MPEG-1/2/4, H.264				
	*.mpg	MPEG-1,MPEG-2				
	*.dat	MPEG-1			MP2	<b>Max Resolution:</b> 352x288 <b>Max Data Rate:</b> 20 Mbps
	*.vob	MPEG-2				<b>Max Resolution:</b> 720x576 <b>Max Data Rate:</b> 20 Mbps
	*.rm *.rmvb	RV8,RV9,RV10		COOK	<b>Max Resolution &amp; Frame Rate:</b> 1280×720@30 fps, <b>Max Data Rate:</b> 10 Mbps	
Music	*.mp3	-	MP3	<b>Sample Rate(KHz):</b> 32~48 <b>Bit Rate(Kbps):</b> 32~320 <b>Channel:</b> Mono/Stereo		
	*.wma	-	WMA	<b>Sample Rate(KHz):</b> 8~48 <b>Bit Rate(Kbps):</b> 128~320 <b>Channel:</b> Mono/Stereo		
	*.AAC	-	MPEG2 AAC	<b>Sample Rate(KHz):</b> 8~48 <b>Bit Rate(Kbps):</b> 128~442 <b>Channel:</b> Mono/Stereo		
	*.M4A	-	MPEG-4 AAC	<b>Channel:</b> Mono/Stereo		
Photo	*.jpg	Baseline JPEG		<b>Max Resolution:</b> 15360×8640		
	*.jpeg	Progressive JPEG		<b>Max Resolution:</b> 1024×768		
	.bmp	--		<b>Max Resolution:</b> 9600×6400		
	.png	Non-interlaced		<b>Max Resolution:</b> 9600×6400		
		Interlaced		<b>Max Resolution:</b> 1200×800		
TEXT	.txt	ANSI/UNICODE GB/UTF8		<b>Max File Size:</b> 1MB		
Notes:						
1. USB Supports file system: Hi Speed FS, FAT32, FAT16, NTFS(compressed NTFS file is not supported). USB支持文件格式: Hi Speed FS, FAT32,FAT16,NTFS (不支持压缩NTFS文件)						
2. Please don't pull out the USB device under operating.请不要在播放时拔USB.						



3. Licenses are required for MPEG, MP3, WMA, especially AC3 and DivX. Licenses需要客户自行获取。
4. Mp4 cannot support GMC. Mp4不支持GMC
5. Max storage capacity is **400G**. The greatest depth of folders is 30.  
最大可接硬盘容量400G，文件夹最多30层。

## 4. INTERFACE DIFINITION (接口定义)

All connecting plug-ins recognize tacitly the square pin as No.1 pin. The pin definition also refers to PCBA bottom silkscreen. No.1 pin of 2.0/2.54mm pitch sockets show as below picture:

Pin脚顺序，PCB封装方脚均表示第1脚。2.0/2.54mm间距插座缺口朝上时，最左边为第1脚，如下图所示：

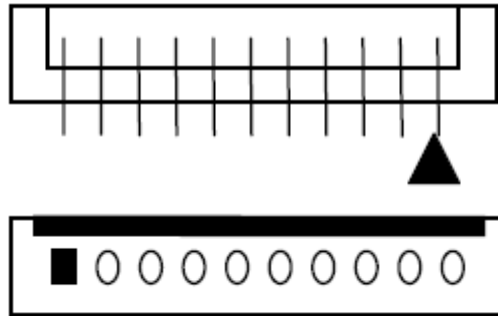

### ◆ CNA1 (2PIN/3.96): AC POWER CONNECTOR 交流电输入端子(3缺1)

NO.	SYMBOL	DESCRIPTION
1	L	AC power L input 交流火线输入
2	N	AC power N input 交流零线输入

### ◆ CNB5 (3PIN/2.0): LED BACKLIGHT CONNECTOR (LED背光)

NO.	SYMBOL	DESCRIPTION
1	+	LED+
2	-	LED-
3	+	LED+

### ◆ CNB7 (3PIN/2.0): LED BACKLIGHT CONNECTOR (LED背光)

NO.	SYMBOL	DESCRIPTION
1	-	LED-
2	+	LED+
3	-	LED-

### ◆ CNB6 (7PIN/2.0): LED BACKLIGHT CONNECTOR (LED背光)

NO.	SYMBOL	DESCRIPTION
1	-	LED-
2	-	LED-

3	+	LED+
4	+	LED+
5	-	LED-
6	-	LED-
7	+	LED+

◆ **CNB8 (2PIN/2.0): LED BACKLIGHT CONNECTOR (LED背光)**

NO.	SYMBOL	DESCRIPTION
1	-	LED-
2	+	LED+

◆ **CNB9 (2PIN/2.0): LED BACKLIGHT CONNECTOR (LED背光)**

NO.	SYMBOL	DESCRIPTION
1	+	LED+
2	-	LED-

◆ **CNB2 (6PIN/FPC1.0): LED BACKLIGHT CONNECTOR (LED背光)**

NO.	SYMBOL	DESCRIPTION
1	-	LED-
2	-	LED-
3	+	LED+
4	+	LED+
5	-	LED-
6	-	LED-

◆ **CNB3 (6PIN/FPC0.5): LED BACKLIGHT CONNECTOR (LED背光)**

NO.	SYMBOL	DESCRIPTION
1	-	LED-
2	-	LED-
3	+	LED+
4	+	LED+
5	-	LED-
6	-	LED-

◆ **CNB4 (6PIN/FPC0.5): LED BACKLIGHT CONNECTOR (LED背光)**

NO.	SYMBOL	DESCRIPTION
1	-	LED-
2	-	LED-
3	+	LED+
4	+	LED+

5	-	LED-
6	-	LED-

◆ CON5 (2x15PIN/2.0): LVDS PANEL CONNECTOR (LVDS屏接口)

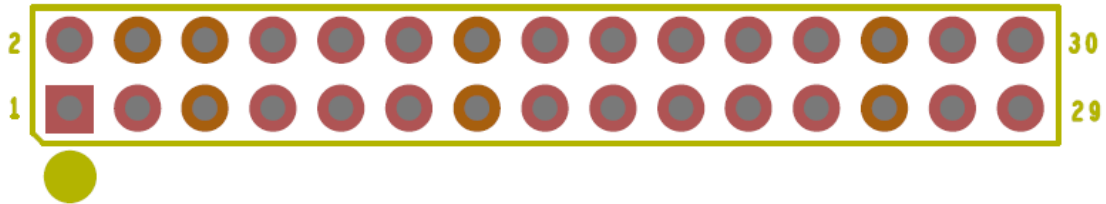

NO.	SYMBOL	DESCRIPTION
1	VCC	Power Supply for Panel 屏电源 (*Note1)
2	VCC	
3	VCC	
4	GND	Ground
5	GND	
6	GND	
7	TX00-	LVDS ODD 0- Signal
8	TX00+	LVDS ODD 0+ Signal
9	TX01-	LVDS ODD 1- Signal
10	TX01+	LVDS ODD 1+ Signal
11	TX02-	LVDS ODD 2- Signal
12	TX02+	LVDS ODD 2+ Signal
13	GND	Ground
14	GND	
15	TXOC-	LVDS ODD Clock- Signal
16	TXOC+	LVDS ODD Clock+ Signal
17	TX03-	LVDS ODD 3- Signal
18	TX03+	LVDS ODD 3+ Signal
19	TXE0-	LVDS EVEN 0- Signal
20	TXE0+	LVDS EVEN 0+ Signal
21	TXE1-	LVDS EVEN 1- Signal
22	TXE1+	LVDS EVEN 1+ Signal
23	TXE2-	LVDS EVEN 2- Signal
24	TXE2+	LVDS EVEN 2+ Signal
25	GND	Ground
26	GND	
27	TXEC-	LVDS EVEN Clock- Signal
28	TXEC+	LVDS EVEN Clock+ Signal

29	TXE3-	LVDS EVEN 3- Signal
30	TXE3+	LVDS EVEN 3+ Signal

**\*Note1:** Please choose right panel VCC voltage (12V/5V) through jump **JP1** in main board, Or the main board or panel will be damaged. 注意屏电压通过主板**JP1**跳线选择，电压不匹配可能烧毁屏！

#### ◆ CON9 (14PIN/2.0): IR&KEY BOARD CONNECTOR 遥控按键接口

NO.	SYMBOL	DESCRIPTION
1	GND	Ground
2	K7	ADC KEY7 (Reserved) 预留按键接口
3	K6/P	ADC KEY6 (Power Key default) 默认电源键
4	K5/M	ADC KEY5 (Menu Key default) 默认菜单键
5	K4/V-	ADC KEY4 (Volume- Key default) 默认音量减键
6	K3/V+	ADC KEY3 (Volume+ Key default) 默认音量加键
7	K2/CH-	ADC KEY2 (CH- Key default) 默认频道减键
8	K1/CH+	ADC KEY1 (CH+ Key default) 默认频道加键
9	K0/S	ADC KEY0 (Source Key default) 默认信号源键
10	GND	Ground
11	IR	Remote control 红外遥控接收
12	GRN	Green indicator 绿色指示灯
13	RED	Red indicator 红色指示灯
14	5V	+5V power supply for IR 遥控接收头5V供电

**\*Note1:** Default key function is strongly recommended, please don't change it, especially for Power key and CH+/- key. If you want use ADC key board, you need connect pin3:K6/P, and leave pin4 -9 open, please contact our HW engineer first for reference key board application circuit.

推荐不改变默认的按键定义顺序，特别是电源和频道加减键。如果希望使用2P线连接按键板，请连接第3脚用于按键电压采样，并请联系敝公司工程师提供参考的按键板电路图。

#### ◆ CON6 (4PIN/2.54): SPEAKER CONNECTOR 喇叭接口

NO.	SYMBOL	DESCRIPTION
1	R+	Audio Right Channel Output+ 右声道正输出
2	R-	Audio Right Channel Output- 右声道负输出
3	L-	Audio Left Channel Output- 左声道负输出
4	L+	Audio Left Channel Output+ 左声道正输出

## 5. SAFETY (安规)

The power supply compliance with the following Criterion:

电源安全性满足下列标准:

**IEC60950、UL60950、IEC60065、GB4943-2001**

## 6. EMC (电磁兼容性)

### 6.1 EMI (电磁干扰)

The power supply shall compliance with the following Criterion:

电源电磁干扰满足下列规则:

#### 1) Conduction Emission: (传导干扰度)

**EN55022, CLASS B**

**GB9254, CLASS B**

#### 2) Radiate Emission: (辐射干扰度)

**FCC PART15, CLASS B**

**EN55022, CLASS B**

**GB9254, CLASS B**

### 6.2 EMS (电磁抗扰)

The power supply shall compliance with the following Criterion:

电源电磁干扰满足下列规则:

#### 1) ESD (静电抗扰度)

**\*GB17626.2-1998/IEC61000-4-2**

#### 2) EFT (脉冲群抗扰度)

**\*GB17626.4-1998/IEC61000-4-4**

3KV±1kV 瞬时测试, ±2kV (AC line noise)

#### 3) Surge (雷击浪涌)

**\*GB17626.5-1998/IEC61000-4-5** ±1KV

**\*GB17626.5-1998/IEC61000-4-5** ±1KV

## 7. PCB Dimension 尺寸图

The overall height of 3A-V59S-A is 18 mm.

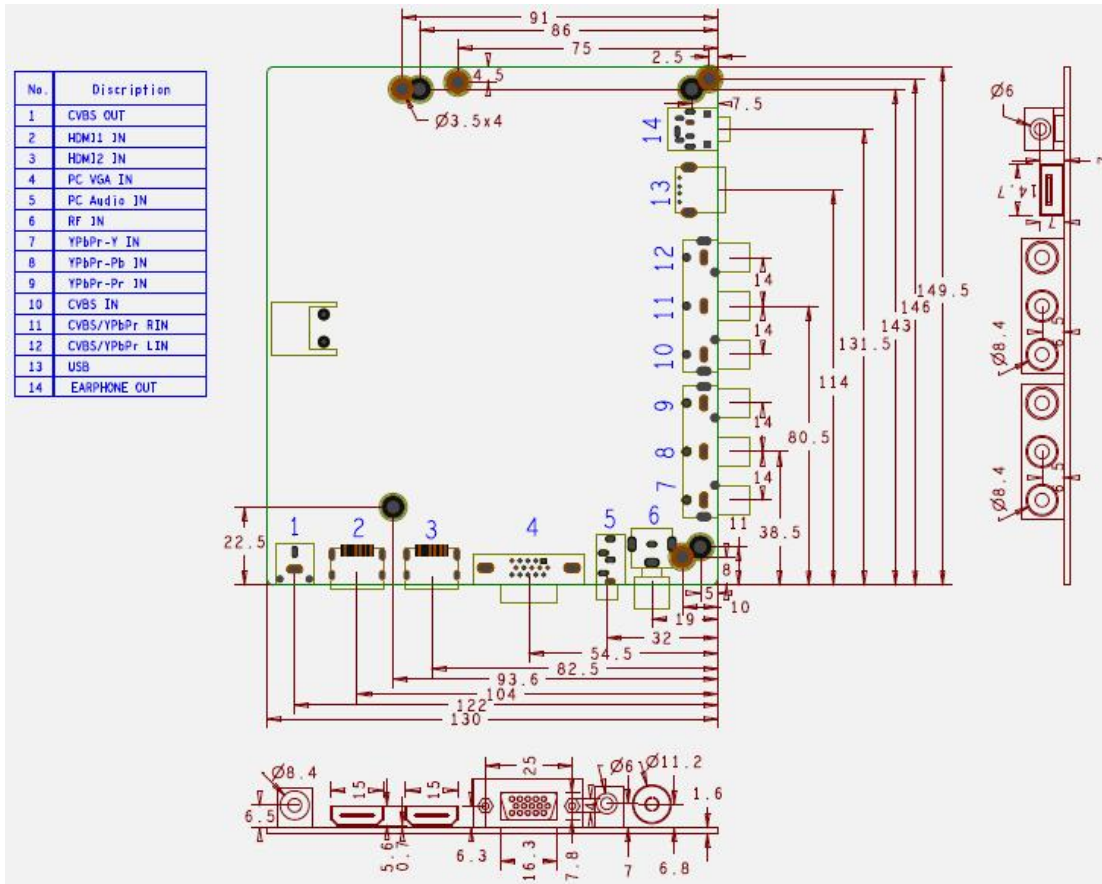

备注: NTSC的高频头接口为螺纹头

## 8. IR & KEY REFERENCE SCHEMATIC 遥控按键参考电路图

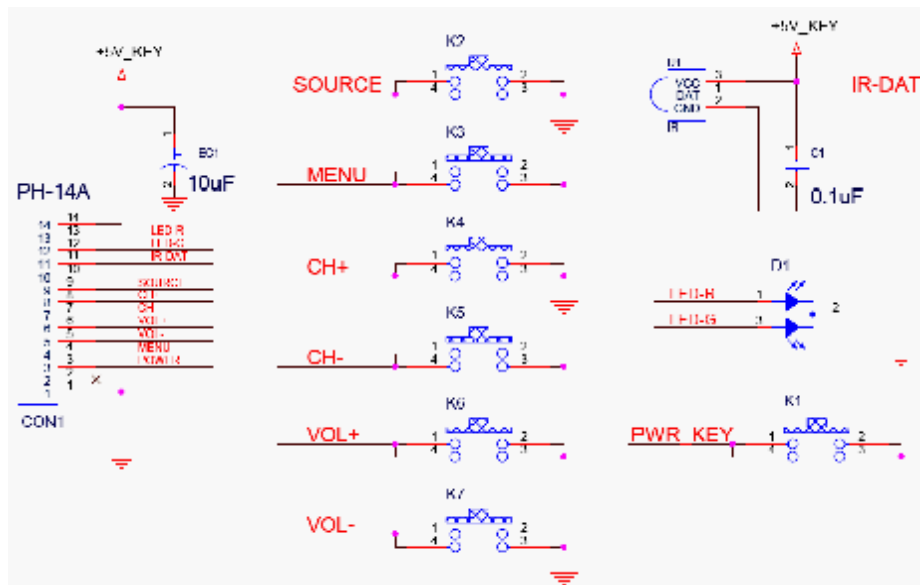

## 9. CONFIGURATION & GENERAL PRECAUTIONS

### 使用环境和注意事项

- Storage temperature: -10~60°C.
- 存储温度: -10~60°C。
- Operation temperature: 0~40°C.
- 工作温度: 0~40°C。
- Operating: 10% to 90% (Non-condensing , 无冷凝)
- 工作湿度: 10% ~ 90%
- Store: 5% to 95%
- 储存湿度: 5%~95%
- Operating: 10,000ft (max)
- 工作高度: 10,000ft (最大)
- Store: 20,000ft (max)
- 储存高度: 20,000ft (最大)
- Vibration ( 振动) 5-55Hz, 19.6m/s<sup>2</sup>(2G), 20minutes each along X, Y and Z axis.
- Protect the board from static electricity in case of damage to the IC.
- 请使板卡远离静电。
- Keep the board away from conductor when it is working.
- 请确保板卡工作时远离导体。
- Don't push or pull the connectors when the board is working.
- 板卡工作时请勿按压和扭曲。
- Don't press, distort or disassemble the board.
- 请勿拆解板卡。
- Clean the board with soft dry cloth when it's dirty.
- 如果板卡脏了, 请用干布擦拭。
- Don't wire in the board to power supply before panel is correctly connected.
- 正确接好驱屏线前请勿接通电源。
- The hole of VGA socket is recommended the situation of not using the screw stationary on the VGA socket to fix on the structural parts of TV.
- VGA插座固定螺帽孔不建议锁在外壳或挡板上, 建议结构设计时整体开槽。
- Inner wires of the whole set should match reasonable, we suggest the LVDS twisted pair wire between the main board and panel must be tied up well and try to use shielding wire. If it's possible, try to put on the magnetic belt ring on the wire which near the board terminal, each connected wire try to not directly cross the PCB board, especially cross over from the main chips, avoid affecting the whole set EMC performance.
- 机内需合理布线, 芯片上方不建议走线, LVDS屏线必须使用双绞线并建议使用屏蔽网, 同时将地环锁死在PCB孔位上。

## 10. MOUNT PRECAUTIONS 组装注意事项

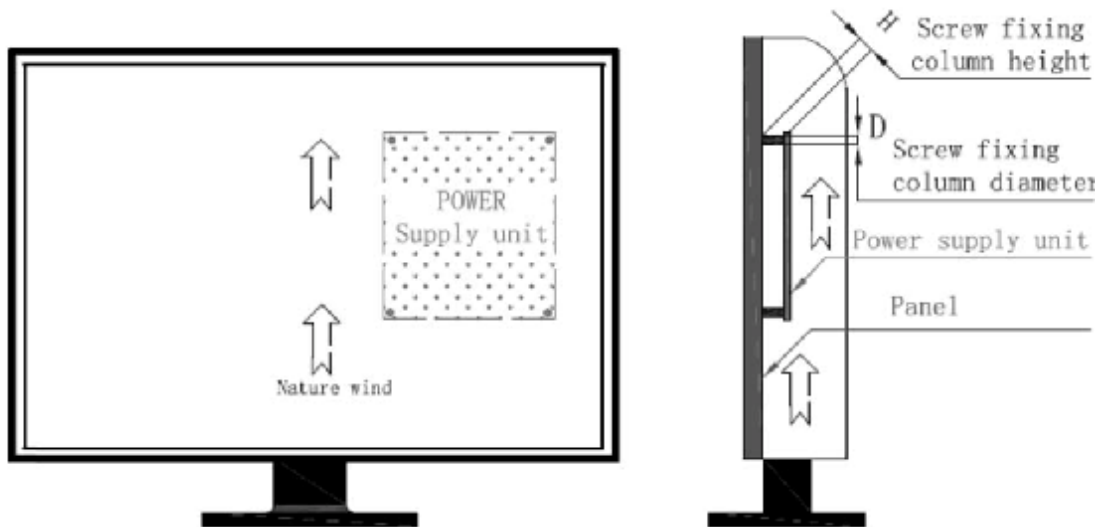

**Note1:** The H should be greater than or equal 8mm, otherwise you must add the mylar under PCB bottom. H 的高度必须大于等于8mm,如果小于8mm,则必须在PCB 底层加麦拉片绝缘。

**Note2:** The D should be less than 8mm .Mount the power supply unit to the screw fixing column using M3 screw. The maximum value of the tightening torque is 0.4NN-M.D 的直直径须小于8mm, 将电源锁在螺丝柱上需使用M3 的螺丝。最大扭力为0.4N-M。

**Note3:** The Power supply unit is usually designed without the case. Please take care about ESD at any time. 因为本产品为无外壳之设计, 故在任何时候均应注意静电防护。

## 11. PACKING, SHIPPING & STORING (包装、运输、贮存)

### 11.1、Packing (包装)

Product name, part number, supplier's logo, QC stamp, Pb-free display and date must be printed on the package case.

包装箱上有产品名称、型号、厂家标识、厂家质量部门的检验合格证、制造日期等。

### 11.2、Shipping (运输)

This product can be transported through land, sea or air. Measures should be taken for water and sun proof. Also, it should be handled with care.

适应于车、船、飞机运输, 运输中应遮蓬、防晒、文明装卸。

### 11.3、Storing(贮存)

Please keep staying in the package case before using and keep away from hazardous gas, flammable or explosive substances and erosive chemical material. Avoid dramatic vibration or shock and strong magnetic field. The package cases should be racked 20cm above the ground and 50cm away from the wall, window, heat source or ventilation port. Generally the storage term of this product is 2 years. All the products should be double checked after that time.

产品未使用时应存放在包装箱内, 仓库内不允许有有害气体, 易燃, 易爆的产品及有腐蚀性的化学物品, 并且无强烈的机械振动, 冲击和强磁场作用, 包装箱应垫离地至少20cm高, 距离墙壁、热源、窗口或空气入口至少50cm, 在本规定条件下的贮存期一般为2年, 超过2年后应重新进行检验。