

ESD PROTECTION DEVICE

STAND-OFF VOLTAGE - 5.0 Volts
POWER DISSIPATION - 120 WATTS

GENERAL DESCRIPTION

The L12ESDL5V0C6-4 is ultra low capacitance TVS arrays designed to protect high speed data interfaces. This series has been specifically designed to protect sensitive components which are connected to high-speed data and transmission lines from overvoltage caused by ESD (electrostatic discharge), CDE (Cable Discharge Events), and EFT (electrical fast transients).

FEATURES

- Protects up to four I/O lines (Data lines) & power line (Vcc pin5)
- Low capacitance: 0.3pF typical (I/O to I/O)
- Low clamping voltage
- IEC 61000-4-2, level 4 (ESD), > ±15KV (air) ; > ±8KV (contact).

APPLICATION

- High Definition Multimedia Interface (HDMI)
- Digital Visual Interface (DVI)
- Monitors and Flat Panel Displays
- USB 2.0
- USB OTG
- IEEE 1394 Firewire Port

MECHANICAL DATA

- Case Material: "Green" molding compound UL flammability classification 94V-0 (No Br,Sb, Cl)
- Terminals: Lead Free Plating (Matte Tin Finish)
- Component in accordance to RoHs 2002/95/E

SOT23-6L

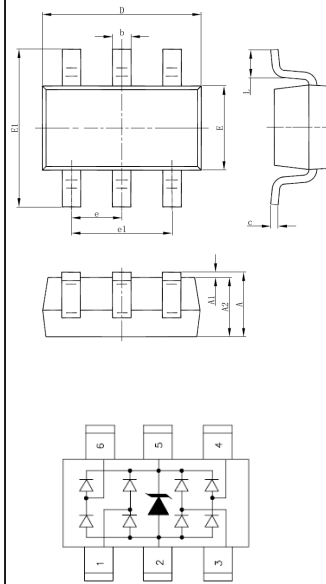

| SOT23-6L | | |
|----------|-----------|------|
| DIM. | MIN. | MAX. |
| A | 0.90 | 1.45 |
| A1 | 0.00 | 0.15 |
| A2 | 0.90 | 1.30 |
| b | 0.30 | 0.50 |
| c | 0.08 | 0.22 |
| D | 2.45 | 3.00 |
| E | 1.50 | 1.75 |
| E1 | 2.80 typ. | |
| e | 0.95 typ. | |
| e1 | 1.90 typ. | |
| L | 0.30 | 0.60 |

All Dimensions in millimeter

| PIN ASSIGNMENT | |
|----------------|-----------------|
| 1, 3, 4, 6 | I/O Lines |
| 5 | V _{CC} |
| 2 | Ground |

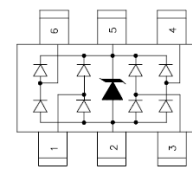

4 lines Protection

MAXIMUM RATINGS (Tj= 25°C unless otherwise noticed)

| Rating | Symbol | Value | Unit |
|--------------------------------------|------------------|--------------|------|
| Peak Pulse Power (tp = 8/20us) | P _{pk} | 120 | W |
| Peak Pulse Current (tp = 8/20us) | I _{pp} | 5 | A |
| Operating Junction Temperature Range | T _J | -55 to + 125 | °C |
| Storage Temperature Range | T _{stg} | -55 to + 150 | °C |
| Soldering Temperature, t max = 10s | T _L | 260 | °C |

ELECTRICAL CHARACTERISTICS (Tj= 25°C unless otherwise noticed)

| Parameter | Symbol | Conditions | Min | Typ | Max | Unit |
|--------------------------|------------------|--|-----|-----|-----|------|
| Reverse standoff voltage | V _{RWM} | Any pin to ground | --- | --- | 5.0 | V |
| Breakdown voltage | V _{BR} | I _R = 1 mA | 6.0 | --- | --- | V |
| Reverse leakage current | I _{RM} | V _{DRM} = 5V | --- | --- | 1 | uA |
| Clamping Voltage | V _C | I _{PP} = 1A, tp = 8/20μs, Any I/O pin to ground | --- | --- | 15 | V |
| Clamping Voltage | V _C | I _{PP} = 5A, tp = 8/20μs, Any I/O pin to ground | --- | --- | 24 | V |
| Junction capacitance | C _J | V _R = 2.5V, f = 1MHz, Any I/O pin to ground | --- | --- | 0.8 | pF |
| Junction capacitance | C _J | V _R = 2.5V, f = 1MHz, Between I/O pins | --- | --- | 0.4 | pF |

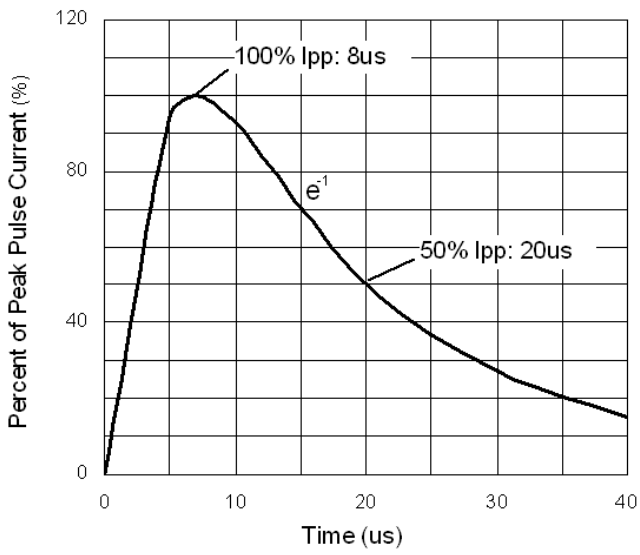

Figure 1. 8/20 us pulse waveform according to IEC 61000-4-5

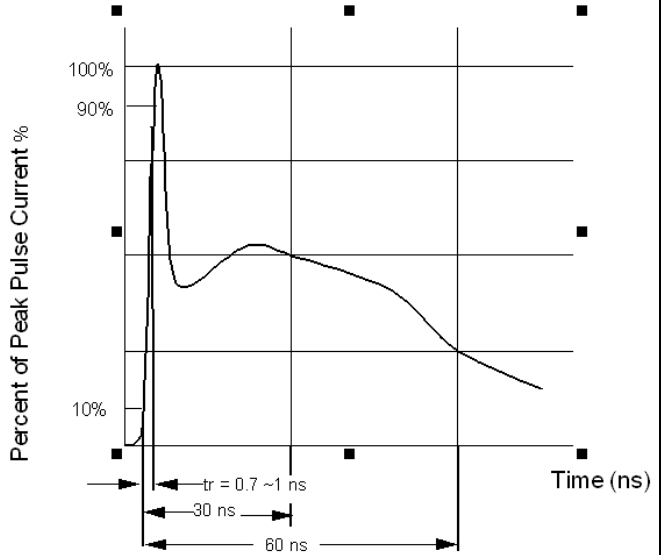

Figure 2. ESD pulse waveform according to IEC 61000-4-2

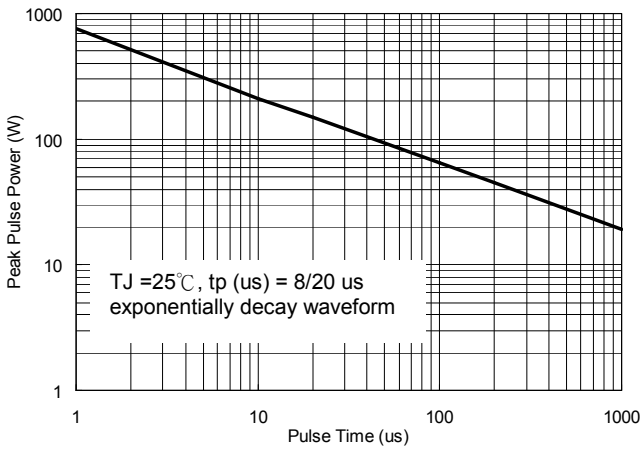

Figure 3. Power Dissipation versus Pulse Time

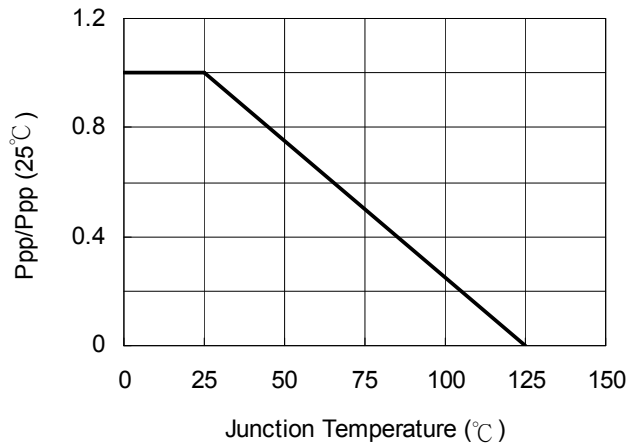

Figure 4. Peak pulse power versus TJ

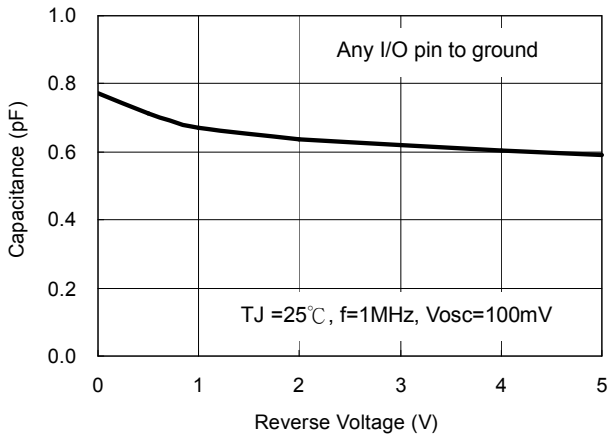

Figure 5. Typical Junction Capacitance

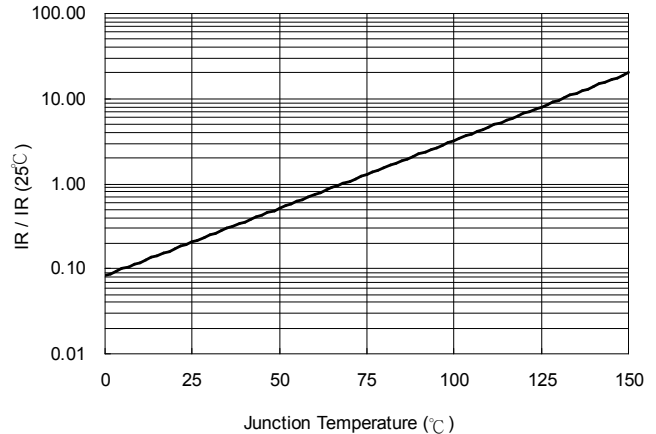

Figure 6. Reverse Leakage Current versus TJ

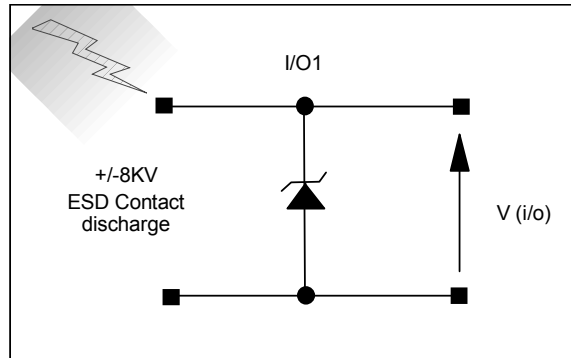

Figure 7. ESD Test Configuration

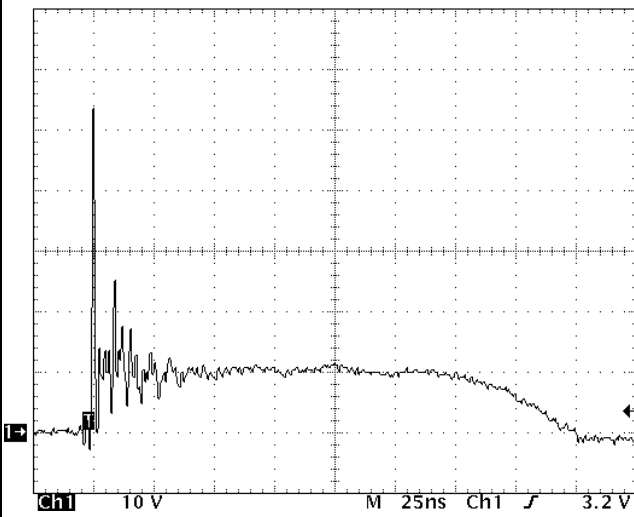

Figure 8. Clamped +8 kV ESD voltage waveform

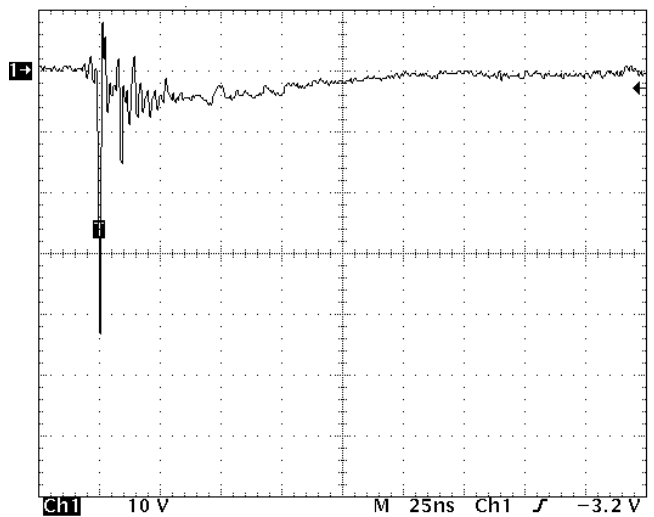
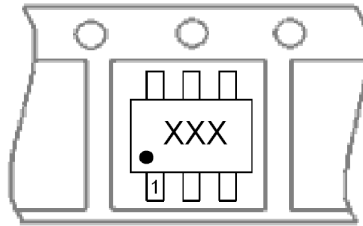

Figure 9. Clamped -8 kV ESD voltage waveform

Marking & Orientation



| DEVICE | Wire | Marking | Packing |
|-----------------|------|---------|---------------|
| L12ESDL5V0C6-4 | Au | LC5 | Taping / Reel |
| L12ESDL5V0C6-4C | Cu | LCV | Taping / Reel |

Packaging Information

| DEVICE | Q'TY/REEL (PCS) | REEL DIA. (INCH) | Q'TY/BOX (PCS) | Q'TY/CARTON (PCS) |
|-----------------------------------|-----------------|------------------|----------------|-------------------|
| L12ESDL5V0C6-4 L12ESDL5V0C6-4C | 3000 | 7 | 45000 | 90K/180K |

SOT23-6L Soldering Pad Layout

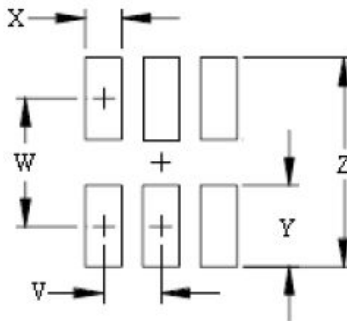

| Dim. | Millimeters | Inches |
|------|-------------|--------|
| Z | 3.60 | 0.141 |
| X | 0.80 | 0.031 |
| W | 2.60 | 0.102 |
| Y | 1.00 | 0.039 |
| V | 0.95 | 0.037 |

Important Notice and Disclaimer

LSC reserves the right to make changes to this document and its products and specifications at any time without notice. Customers should obtain and confirm the latest product information and specifications before final design, purchase or use.

LSC makes no warranty, representation or guarantee regarding the suitability of its products for any particular purpose, nor does LSC assume any liability for application assistance or customer product design. LSC does not warrant or accept any liability with products which are purchased or used for any unintended or unauthorized application.

No license is granted by implication or otherwise under any intellectual property rights of LSC.

LSC products are not authorized for use as critical components in life support devices or systems without express written approval of LSC.