

# Infrared LED

## L1909

TO-46 type GaAlAs infrared LED

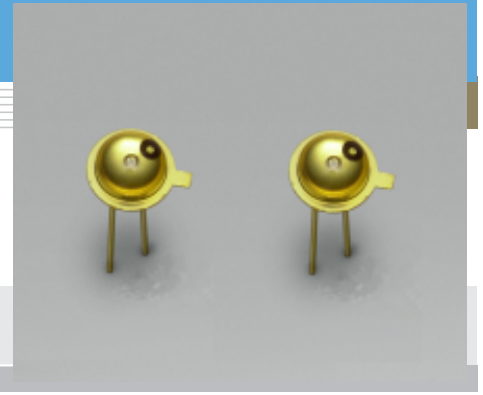

### Features

- High radiant output power
- Direct modulation possible
- High reliability and long life

### Applications

- Auto-focus
- Automatic control systems
- Optical switches
- Mark sensors
- Optical remote control

#### ■ Absolute maximum ratings (Ta=25 °C)

Parameter	Symbol	Condition	Value	Unit
Forward current	IF		80	mA
Reverse voltage	VR		5	V
Pulse forward current	IFP	Pulse width=10 μs Duty ratio=1 %	1.0	A
Operating temperature	Topr		-30 to +85	°C
Storage temperature	Tstg		-40 to +100 *	°C

\* Guaranteed to resist temperature cycle test of up to 5 cycles.

#### ■ Electrical and optical characteristics (Ta=25 °C)

Parameter	Symbol	Condition	Min.	Typ.	Max.	Unit
Peak emission wavelength	$\lambda_p$	IF=50 mA	870	890	920	nm
Spectral half width	$\Delta\lambda$	IF=50 mA	-	80	-	nm
Forward voltage	VF	IF=50 mA	-	1.4	1.5	V
Pulse forward voltage	VFP	IF=1.0 A	-	2.8	3.4	V
Reverse current	IR	VR=5 V	-	-	5	μA
Radiant flux	$\phi_e$	IF=50 mA	8	10	-	mW
Radiant illuminance	PE	IF=50 mA	-	1.0	-	mW/cm <sup>2</sup>
Rise time	tr	IF=50 mA, 10 to 90 %	-	0.45	0.7	μs
Fall time	tf	IF=50 mA, 90 to 10 %	-	0.45	0.7	μs

## Emission spectrum

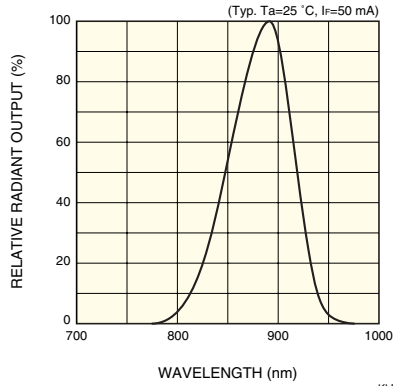

KLEDB0117EB

## Radiant flux vs. forward current

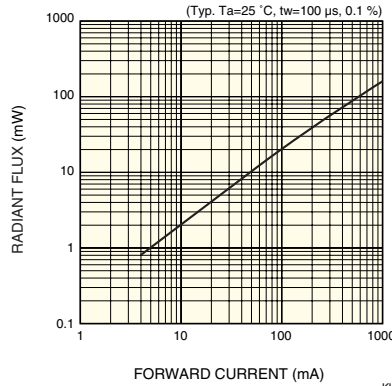

KLEDB0120EA

## Forward current vs. forward voltage

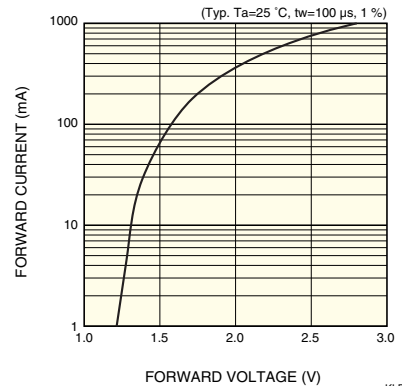

KLEDB0121EA

## Directivity

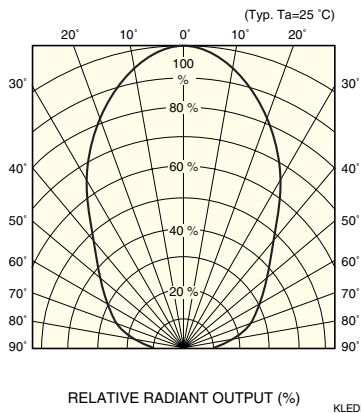

KLEDB0118EA

## Radiant output vs. ambient temperature

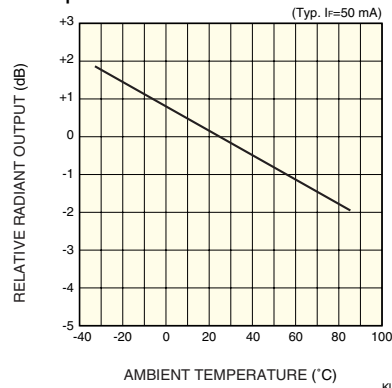

KLEDB0150EA

## Allowable forward current vs. ambient temperature

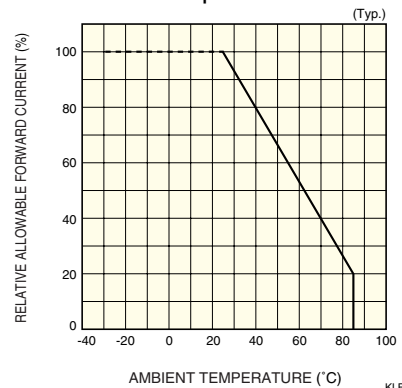

KLEDB0027EB

## Allowable forward current vs. duty ratio

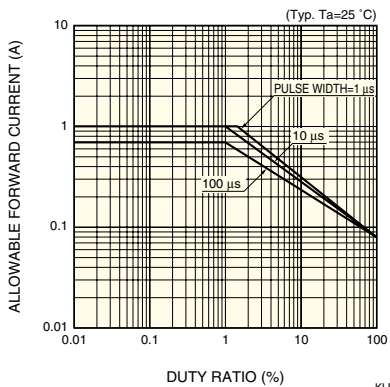

KLEDB0038EA

## Dimensional outline (unit: mm)

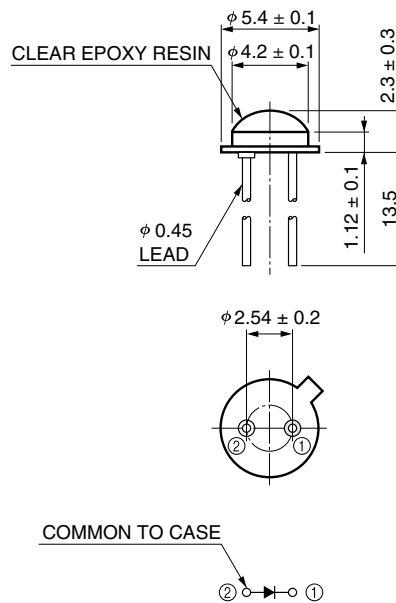

KLEDA0009ED

# HAMAMATSU

HAMAMATSU PHOTONICS K.K., Solid State Division

1126-1 Ichino-cho, Hamamatsu City, 435-8558 Japan, Telephone: (81) 053-434-3311, Fax: (81) 053-434-5184, <http://www.hamamatsu.com>

U.S.A.: Hamamatsu Corporation: 360 Foothill Road, P.O.Box 6910, Bridgewater, N.J. 08807-0910, U.S.A., Telephone: (1) 908-231-0960, Fax: (1) 908-231-1218

Germany: Hamamatsu Photonics Deutschland GmbH: Arzbergerstr. 10, D-82211 Herrsching am Ammersee, Germany, Telephone: (49) 08152-3750, Fax: (49) 08152-2658

France: Hamamatsu Photonics France S.A.R.L.: 8, Rue du Saule Trapu, Parc du Moulin de Massy, 91882 Massy Cedex, France, Telephone: 33-(1) 69 53 71 00, Fax: 33-(1) 69 53 71 10

United Kingdom: Hamamatsu Photonics UK Limited: 2 Howard Court, 10 Tewin Road, Welwyn Garden City, Hertfordshire AL7 1BW, United Kingdom, Telephone: (44) 1707-294888, Fax: (44) 1707-325777

North Europe: Hamamatsu Photonics Norden AB: Smidesvägen 12, SE-171 41 Solna, Sweden, Telephone: (46) 8-509-031-00, Fax: (46) 8-509-031-01

Italy: Hamamatsu Photonics Italia S.R.L.: Strada della Moia, 1/E, 20020 Arese, (Milano), Italy, Telephone: (39) 02-935-81-733, Fax: (39) 02-935-81-741

Information furnished by HAMAMATSU is believed to be reliable. However, no responsibility is assumed for possible inaccuracies or omissions. Specifications are subject to change without notice. No patent rights are granted to any of the circuits described herein. ©2001 Hamamatsu Photonics K.K.