



Website:<http://biz.LGservice.com>

COLOR MONITOR

SERVICE MANUAL

CHASSIS NO. : LM57A

MODEL:FLATRONL1753S (L1753S-*FS.A***QP)

FLATRONL1953S (L1953S-*FS.A***QP)

() **Same model for Service

CAUTION

BEFORE SERVICING THE UNIT,
READ THE **SAFETY PRECAUTIONS** IN THIS MANUAL.

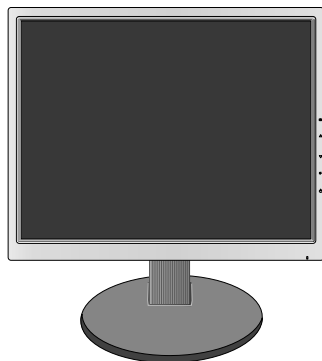

*To apply the **MSTAR Chip**.

CONTENTS

SPECIFICATIONS	2	SERVICE OSD	17
PRECAUTIONS	3	TROUBLESHOOTING GUIDE	18
TIMING CHART	7	WIRING DIAGRAM	24
DISASSEMBLY	8	EXPLODED VIEW	25
BLOCK DIAGRAM.....	12	REPLACEMENT PARTS LIST	27
DISCRIPTION OF BLOCK DIAGRAM	13	SCHEMATIC DIAGRAM.....	31
ADJUSTMENT	16		

SPECIFICATIONS

1. LCD CHARACTERISTICS

Type : TFT Color LCD Module
 Active Display Area : 17 inch - **L1753S**
 : 19 inch - **L1953S**
 Pixel Pitch : 0.264 (H) x 0.264 (V) - **L1753S**
 : 0.294 (H) x 0.294 (V) - **L1953S**
 Color Depth : 8bits, 16.2M colors
 Size : 358.5 (H) x 296.5 (V) x 17.0(D) - **L1753S**
 : 396 (H) x 324 (V) x 17.5(D) - **L1953S**
 Electrical Interface : LVDS
 Surface Treatment : Hard-coating(3H), Anti-Glare
 Operating Mode : Normally White, Transmissive mode
 Backlight Unit : 4-CCFL

2. OPTICAL CHARACTERISTICS

2-1. Viewing Angle by Contrast Ratio ≥ 10

Left : -60° min., -70°(Typ) Right : +60° min., +70°(Typ)
 Top : +60° min., +75°(Typ) Bottom : -50° min., -65°(Typ)

2-2. Luminance : 230(min), 300(Typ) (Full White pattern, 0.70V) -**6500K**
 : 150(min) (Full White pattern, 0.70V) -**9300K**
 75%(min)

2-3. Contrast Ratio : 2000:1 (DFC)

3. SIGNAL (Refer to the Timing Chart)

3-1. Sync Signal
 • Type : Separate Sync, SOG

3-2. Video Input Signal
 1) Type : R, G, B Analog
 2) Voltage Level : 0~0.71 V
 a) Color 0, 0 : 0 Vp-p
 b) Color 7, 0 : 0.467Vp-p
 c) Color 15, 0 : 0.714Vp-p
 3) Input Impedance : 75 Ω

3-3. Operating Frequency
 Horizontal : 30 ~ 83kHz
 Vertical : 56 ~ 75Hz

4. Max. Resolution

D-sub Analog : 1280 x 1024@75Hz

5. POWER SUPPLY

5-1. Power : AC 100~240V, 50/60Hz , 0.6A

5-2. Power Consumption

MODE	H/V SYNC	VIDEO	POWER CONSUMPTION	LED COLOR
POWER ON (NORMAL)	ON/ON	ACTIVE	less than 35 W - L1753S	BLUE
			less than 39 W - L1953S	or GREEN
STAND-BY	OFF/ON	OFF	less than 1 W	AMBER
SUSPEND	ON/OFF	OFF	less than 1 W	AMBER
DPMS OFF	OFF/OFF	OFF	less than 1 W	AMBER
POWER S/W Off	-	-	less than 1 W	OFF

6. ENVIRONMENT

6-1. Operating Temperature : 10°C~35°C (50°F~95°F)
 (Ambient)

6-2. Relative Humidity : 10%~80% (Non-condensing)

6-3. MTBF : 50,000 HRS with 90% Confidence
 Lamp Life : 50,000 Hours(Min)

7. DIMENSIONS (with TILT/SWIVEL)

L1753S
 Width : 364.5 mm (14.35")
 Depth : 180 mm (7.09")
 Height : 378.2 mm (14.89")

L1953S
 Width : 402 mm (15.83")
 Depth : 180 mm (7.09")
 Height : 407.5 mm (16.04")

8. WEIGHT (with TILT/SWIVEL)

L1753S
 Net. Weight : 3.3 kg (7.28 lbs)
 Gross Weight : 4.4 kg (9.70 lbs)

L1953S
 Net. Weight : 4.2 kg (9.26 lbs)
 Gross Weight : 5.4 kg (11.91 lbs)

PRECAUTION

WARNING FOR THE SAFETY-RELATED COMPONENT.

- There are some special components used in LCD monitor that are important for safety. **These parts are marked \triangle on the schematic diagram and the replacement parts list.** It is essential that these critical parts should be replaced with the manufacturer's specified parts to prevent electric shock, fire or other hazard.
- Do not modify original design without obtaining written permission from manufacturer or you will void the original parts and labor guarantee.

TAKE CARE DURING HANDLING THE LCD MODULE WITH BACKLIGHT UNIT.

- Must mount the module using mounting holes arranged in four corners.
- Do not press on the panel, edge of the frame strongly or electric shock as this will result in damage to the screen.
- Do not scratch or press on the panel with any sharp objects, such as pencil or pen as this may result in damage to the panel.
- Protect the module from the ESD as it may damage the electronic circuit (C-MOS).
- Make certain that treatment person's body are grounded through wrist band.
- Do not leave the module in high temperature and in areas of high humidity for a long time.
- The module not be exposed to the direct sunlight.
- Avoid contact with water as it may a short circuit within the module.
- If the surface of panel become dirty, please wipe it off with a softmaterial. (Cleaning with a dirty or rough cloth may damage the panel.)

\triangle CAUTION

Please use only a plastic screwdriver to protect yourself from shock hazard during service operation.

\triangle WARNING

BE CAREFUL ELECTRIC SHOCK !

- If you want to replace with the new backlight (CCFL) or inverter circuit, must disconnect the AC adapter because high voltage appears at inverter circuit about 650Vrms.
- Handle with care wires or connectors of the inverter circuit. If the wires are pressed cause short and may burn or take fire.

Leakage Current Hot Check Circuit

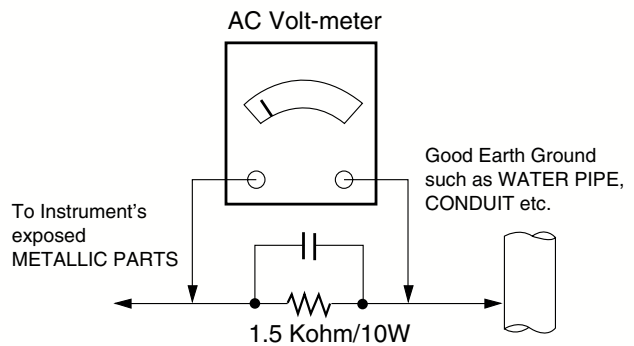

SERVICING PRECAUTIONS

CAUTION: Before servicing receivers covered by this service manual and its supplements and addenda, read and follow the **SAFETY PRECAUTIONS** on page 3 of this publication.

NOTE: If unforeseen circumstances create conflict between the following servicing precautions and any of the safety precautions on page 3 of this publication, always follow the safety precautions. Remember: Safety First.

General Servicing Precautions

1. Always unplug the receiver AC power cord from the AC power source before;
 - a. Removing or reinstalling any component, circuit board module or any other receiver assembly.
 - b. Disconnecting or reconnecting any receiver electrical plug or other electrical connection.
 - c. Connecting a test substitute in parallel with an electrolytic capacitor in the receiver.
CAUTION: A wrong part substitution or incorrect polarity installation of electrolytic capacitors may result in an explosion hazard.
 - d. Discharging the picture tube anode.
2. Test high voltage only by measuring it with an appropriate high voltage meter or other voltage measuring device (DVM, FETVOM, etc) equipped with a suitable high voltage probe.
Do not test high voltage by "drawing an arc".
3. Discharge the picture tube anode only by (a) first connecting one end of an insulated clip lead to the degaussing or kine aquadag grounding system shield at the point where the picture tube socket ground lead is connected, and then (b) touch the other end of the insulated clip lead to the picture tube anode button, using an insulating handle to avoid personal contact with high voltage.
4. Do not spray chemicals on or near this receiver or any of its assemblies.
5. Unless specified otherwise in this service manual, clean electrical contacts only by applying the following mixture to the contacts with a pipe cleaner, cotton-tipped stick or comparable non-abrasive applicator; 10% (by volume) Acetone and 90% (by volume) isopropyl alcohol (90%-99% strength)
CAUTION: This is a flammable mixture.
Unless specified otherwise in this service manual, lubrication of contacts is not required.
6. Do not defeat any plug/socket B+ voltage interlocks with which receivers covered by this service manual might be equipped.
7. Do not apply AC power to this instrument and/or any of its electrical assemblies unless all solid-state device heat sinks are correctly installed.
8. Always connect the test receiver ground lead to the receiver chassis ground before connecting the test receiver positive lead.
Always remove the test receiver ground lead last.

9. Use with this receiver only the test fixtures specified in this service manual.

CAUTION: Do not connect the test fixture ground strap to any heat sink in this receiver.

Electrostatically Sensitive (ES) Devices

Some semiconductor (solid-state) devices can be damaged easily by static electricity. Such components commonly are called *Electrostatically Sensitive (ES) Devices*. Examples of typical ES devices are integrated circuits and some field-effect transistors and semiconductor "chip" components. The following techniques should be used to help reduce the incidence of component damage caused by static by static electricity.

1. Immediately before handling any semiconductor component or semiconductor-equipped assembly, drain off any electrostatic charge on your body by touching a known earth ground. Alternatively, obtain and wear a commercially available discharging wrist strap device, which should be removed to prevent potential shock reasons prior to applying power to the unit under test.
2. After removing an electrical assembly equipped with ES devices, place the assembly on a conductive surface such as aluminum foil, to prevent electrostatic charge buildup or exposure of the assembly.
3. Use only a grounded-tip soldering iron to solder or unsolder ES devices.
4. Use only an anti-static type solder removal device. Some solder removal devices not classified as "anti-static" can generate electrical charges sufficient to damage ES devices.
5. Do not use freon-propelled chemicals. These can generate electrical charges sufficient to damage ES devices.
6. Do not remove a replacement ES device from its protective package until immediately before you are ready to install it. (Most replacement ES devices are packaged with leads electrically shorted together by conductive foam, aluminum foil or comparable conductive material).
7. Immediately before removing the protective material from the leads of a replacement ES device, touch the protective material to the chassis or circuit assembly into which the device will be installed.
CAUTION: Be sure no power is applied to the chassis or circuit, and observe all other safety precautions.
8. Minimize bodily motions when handling unpackaged replacement ES devices. (Otherwise harmless motion such as the brushing together of your clothes fabric or the lifting of your foot from a carpeted floor can generate static electricity sufficient to damage an ES device.)

General Soldering Guidelines

1. Use a grounded-tip, low-wattage soldering iron and appropriate tip size and shape that will maintain tip temperature within the range of 500° F to 600° F.
2. Use an appropriate gauge of RMA resin-core solder composed of 60 parts tin/40 parts lead.
3. Keep the soldering iron tip clean and well tinned.
4. Thoroughly clean the surfaces to be soldered. Use a small wire-bristle (0.5 inch, or 1.25cm) brush with a metal handle.

Do not use freon-propelled spray-on cleaners.

5. Use the following unsoldering technique
 - a. Allow the soldering iron tip to reach normal temperature.
(500° F to 600° F)
 - b. Heat the component lead until the solder melts.
 - c. Quickly draw the melted solder with an anti-static, suction-type solder removal device or with solder braid.

CAUTION: Work quickly to avoid overheating the circuitboard printed foil.

6. Use the following soldering technique.
 - a. Allow the soldering iron tip to reach a normal temperature (500° F to 600° F)
 - b. First, hold the soldering iron tip and solder the strand against the component lead until the solder melts.
 - c. Quickly move the soldering iron tip to the junction of the component lead and the printed circuit foil, and hold it there only until the solder flows onto and around both the component lead and the foil.

CAUTION: Work quickly to avoid overheating the circuit board printed foil.

- d. Closely inspect the solder area and remove any excess or splashed solder with a small wire-bristle brush.

IC Remove/Replacement

Some chassis circuit boards have slotted holes (oblong) through which the IC leads are inserted and then bent flat against the circuit foil. When holes are the slotted type, the following technique should be used to remove and replace the IC. When working with boards using the familiar round hole, use the standard technique as outlined in paragraphs 5 and 6 above.

Removal

1. Desolder and straighten each IC lead in one operation by gently prying up on the lead with the soldering iron tip as the solder melts.
2. Draw away the melted solder with an anti-static suction-type solder removal device (or with solder braid) before removing the IC.

Replacement

1. Carefully insert the replacement IC in the circuit board.
2. Carefully bend each IC lead against the circuit foil pad and solder it.
3. Clean the soldered areas with a small wire-bristle brush. (It is not necessary to reapply acrylic coating to the areas).

"Small-Signal" Discrete Transistor

Removal/Replacement

1. Remove the defective transistor by clipping its leads as close as possible to the component body.
2. Bend into a "U" shape the end of each of three leads remaining on the circuit board.
3. Bend into a "U" shape the replacement transistor leads.
4. Connect the replacement transistor leads to the corresponding leads extending from the circuit board and crimp the "U" with long nose pliers to insure metal to metal contact then solder each connection.

Power Output, Transistor Device

Removal/Replacement

1. Heat and remove all solder from around the transistor leads.
2. Remove the heat sink mounting screw (if so equipped).
3. Carefully remove the transistor from the heat sink of the circuit board.
4. Insert new transistor in the circuit board.
5. Solder each transistor lead, and clip off excess lead.
6. Replace heat sink.

Diode Removal/Replacement

1. Remove defective diode by clipping its leads as close as possible to diode body.
2. Bend the two remaining leads perpendicular y to the circuit board.
3. Observing diode polarity, wrap each lead of the new diode around the corresponding lead on the circuit board.
4. Securely crimp each connection and solder it.
5. Inspect (on the circuit board copper side) the solder joints of the two "original" leads. If they are not shiny, reheat them and if necessary, apply additional solder.

Fuse and Conventional Resistor

Removal/Replacement

1. Clip each fuse or resistor lead at top of the circuit board hollow stake.
2. Securely crimp the leads of replacement component around notch at stake top.
3. Solder the connections.

CAUTION: Maintain original spacing between the replaced component and adjacent components and the circuit board to prevent excessive component temperatures.

Circuit Board Foil Repair

Excessive heat applied to the copper foil of any printed circuit board will weaken the adhesive that bonds the foil to the circuit board causing the foil to separate from or "lift-off" the board. The following guidelines and procedures should be followed whenever this condition is encountered.

At IC Connections

To repair a defective copper pattern at IC connections use the following procedure to install a jumper wire on the copper pattern side of the circuit board. (Use this technique only on IC connections).

1. Carefully remove the damaged copper pattern with a sharp knife. (Remove only as much copper as absolutely necessary).
2. Carefully scratch away the solder resist and acrylic coating (if used) from the end of the remaining copper pattern.
3. Bend a small "U" in one end of a small gauge jumper wire and carefully crimp it around the IC pin. Solder the IC connection.
4. Route the jumper wire along the path of the out-away copper pattern and let it overlap the previously scraped end of the good copper pattern. Solder the overlapped area and clip off any excess jumper wire.

At Other Connections

Use the following technique to repair the defective copper pattern at connections other than IC Pins. This technique involves the installation of a jumper wire on the component side of the circuit board.

1. Remove the defective copper pattern with a sharp knife.
Remove at least 1/4 inch of copper, to ensure that a hazardous condition will not exist if the jumper wire opens.
2. Trace along the copper pattern from both sides of the pattern break and locate the nearest component that is directly connected to the affected copper pattern.
3. Connect insulated 20-gauge jumper wire from the lead of the nearest component on one side of the pattern break to the lead of the nearest component on the other side.

Carefully crimp and solder the connections.

CAUTION: Be sure the insulated jumper wire is dressed so the it does not touch components or sharp edges.

TIMING CHART

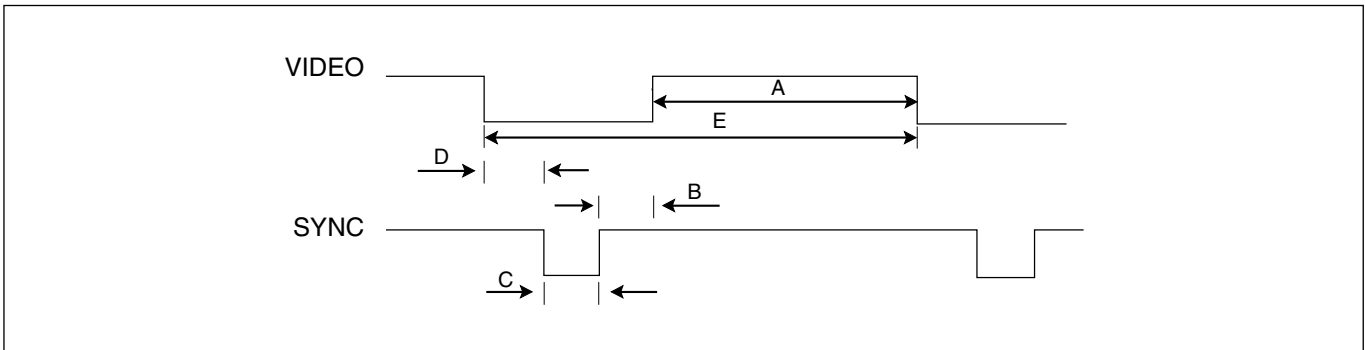

MODE	H / V	Sync Polarity	Dot Clock	Frequency	Total Period (E)	Video Active Time (A)	Sync Duration (D)	Front Porch (C)	Blanking Time (B)	Resolution
1	H(Pixels)	+	25.175	31.469	800	640	16	96	48	640 x 350
	V(Lines)	-		70.09	449	350	37	2	60	
2	H(Pixels)	-	28.321	31.468	900	720	18	108	54	720 X 400
	V(Lines)	+		70.08	449	400	12	2	35	
3	H(Pixels)	-	25.175	31.469	800	640	16	96	48	640 x 480
	V(Lines)	-		59.94	525	480	10	2	33	
4	H(Pixels)	-	31.5	37.5	840	640	16	64	120	640 x 480
	V(Lines)	-		75	500	480	1	3	16	
5	H(Pixels)	+	40.0	37.879	1056	800	40	128	88	800 x 600
	V(Lines)	+		60.317	628	600	1	4	23	
6	H(Pixels)	+	49.5	46.875	1056	800	16	80	160	800 x 600
	V(Lines)	+		75.0	625	600	1	3	21	
7	H(Pixels)	+/-	57.283	49.725	1152	832	32	64	224	832 x 624
	V(Lines)	+/-		74.55	667	624	1	3	39	
8	H(Pixels)	-	65.0	48.363	1344	1024	24	136	160	1024 x 768
	V(Lines)	-		60.0	806	768	3	6	29	
9	H(Pixels)	-	78.75	60.123	1312	1024	16	96	176	1024 x 768
	V(Lines)	-		75.029	800	768	1	3	28	
10	H(Pixels)	+/-	100.0	68.681	1456	1152	32	128	144	1152 x 870
	V(Lines)	+/-		75.062	915	870	3	3	39	
11	H(Pixels)	+/-	92.978	61.805	1504	1152	18	134	200	1152 x 900
	V(Lines)	+/-		65.96	937	900	2	4	31	
12	H(Pixels)	+	108.0	63.981	1688	1280	48	112	248	1280 x 1024
	V(Lines)	+		60.02	1066	1024	1	3	38	
13	H(Pixels)	+	135.0	79.976	1688	1280	16	144	248	1280 x 1024
	V(Lines)	+		75.035	1066	1024	1	3	38	

DISASSEMBLY-Set

1



Soft pad on the table.

2



Monitor on the pad.

3

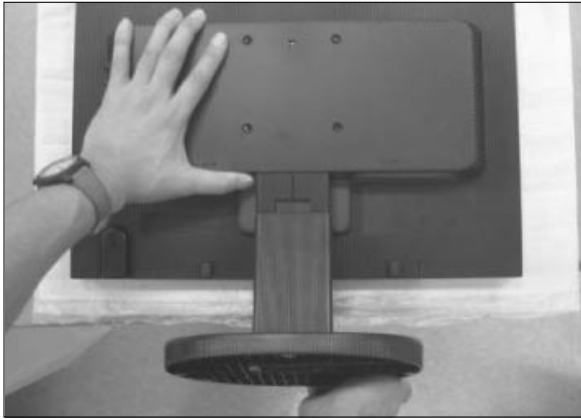

Pull up the stand part.

4-1

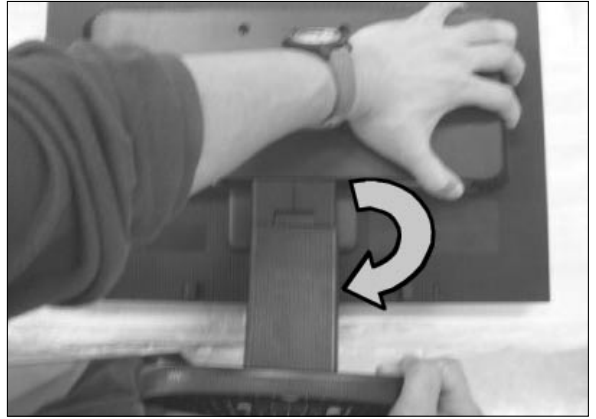

Hold the head & stand base and then
Twist Stand until "Click".

4-2

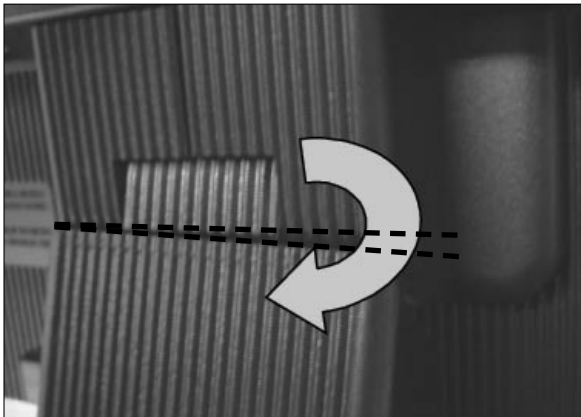

5



Separate head & stand

6

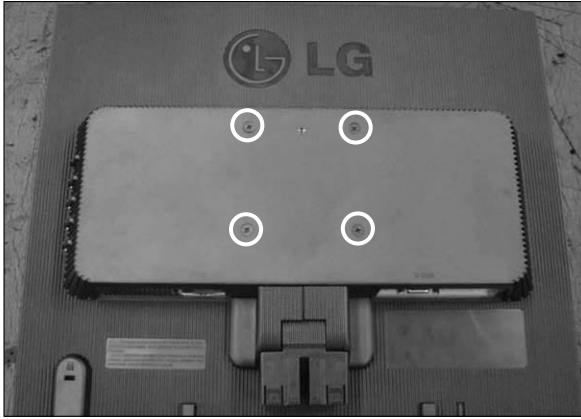

Remove the screws.

7



1. Pull the front cover upward.
2. Then, let the all latches are separated.(#3-1~3-2)
3. Put the front face down.

8



9

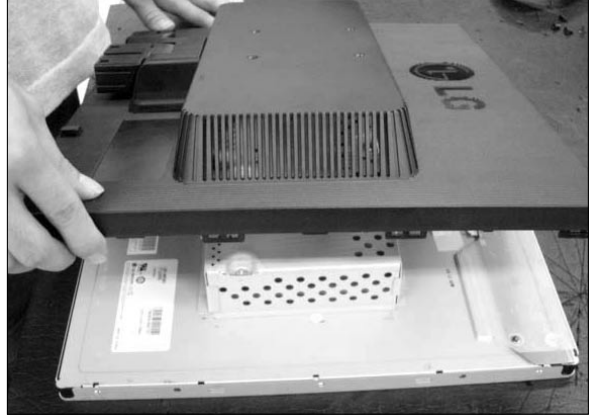

Disassemble back cover.

DISASSEMBLY-Stand

* In case of Latch 4.

1-1

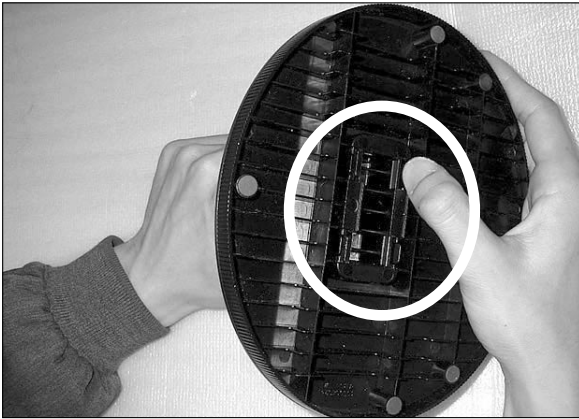

Push the four latches on the bottom to the outside and Separate Stand Body & Base.
(Reference the #1-2)

1-2

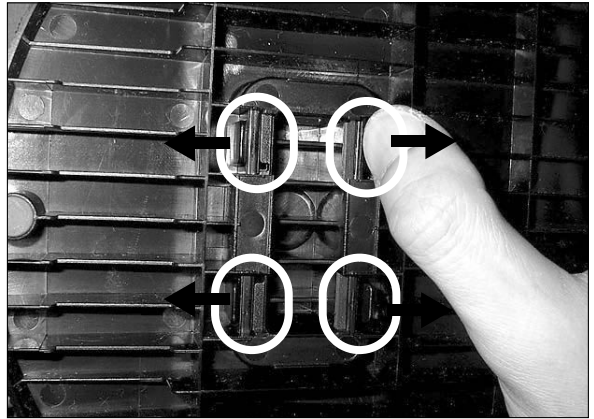

2

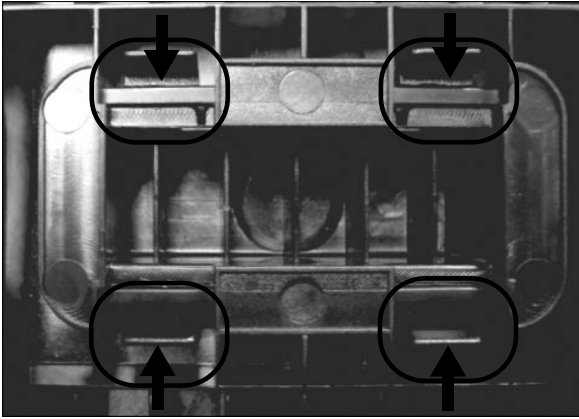

After finished repair, necessarily push 4ea Latches to inside for restoration.

3

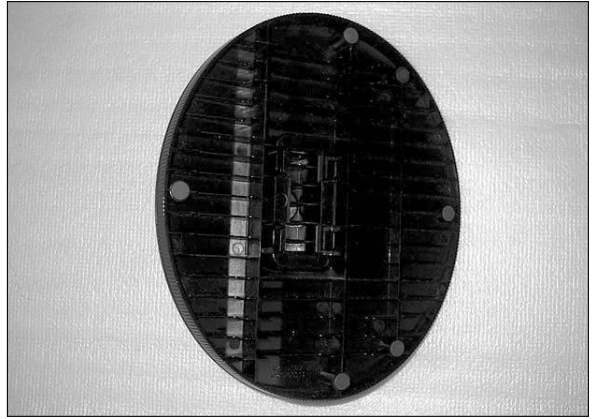

DISASSEMBLY-Stand

* In case of Latch 2.

1



Hold the stand body.

2

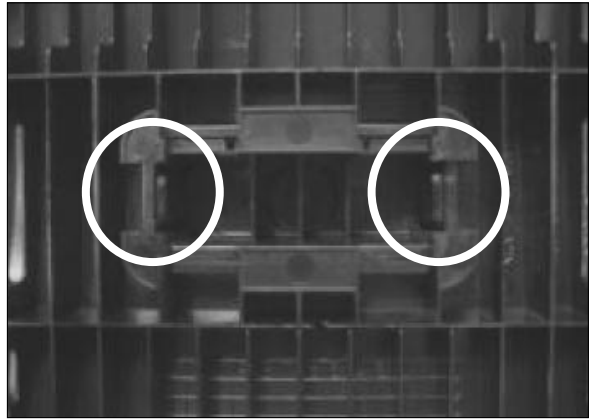

Confirm two latch of right and left.

3

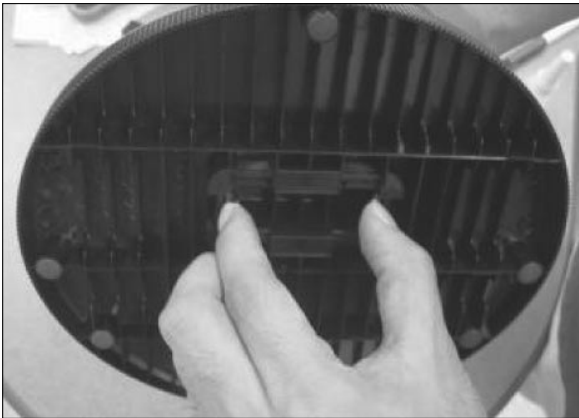

Push the latch to the inside.

4

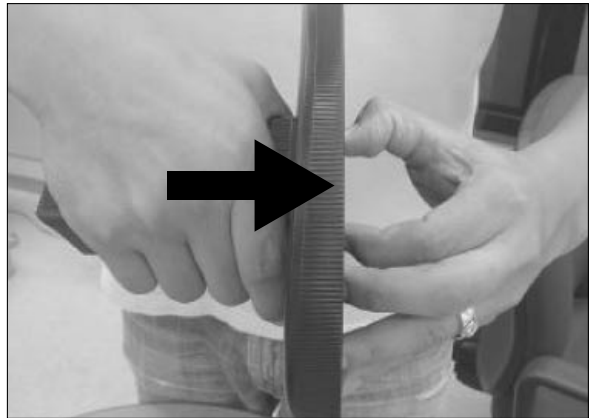

Push the base to the opposite direction.

5



Confirm the condition of separation.

BLOCK DIAGRAM

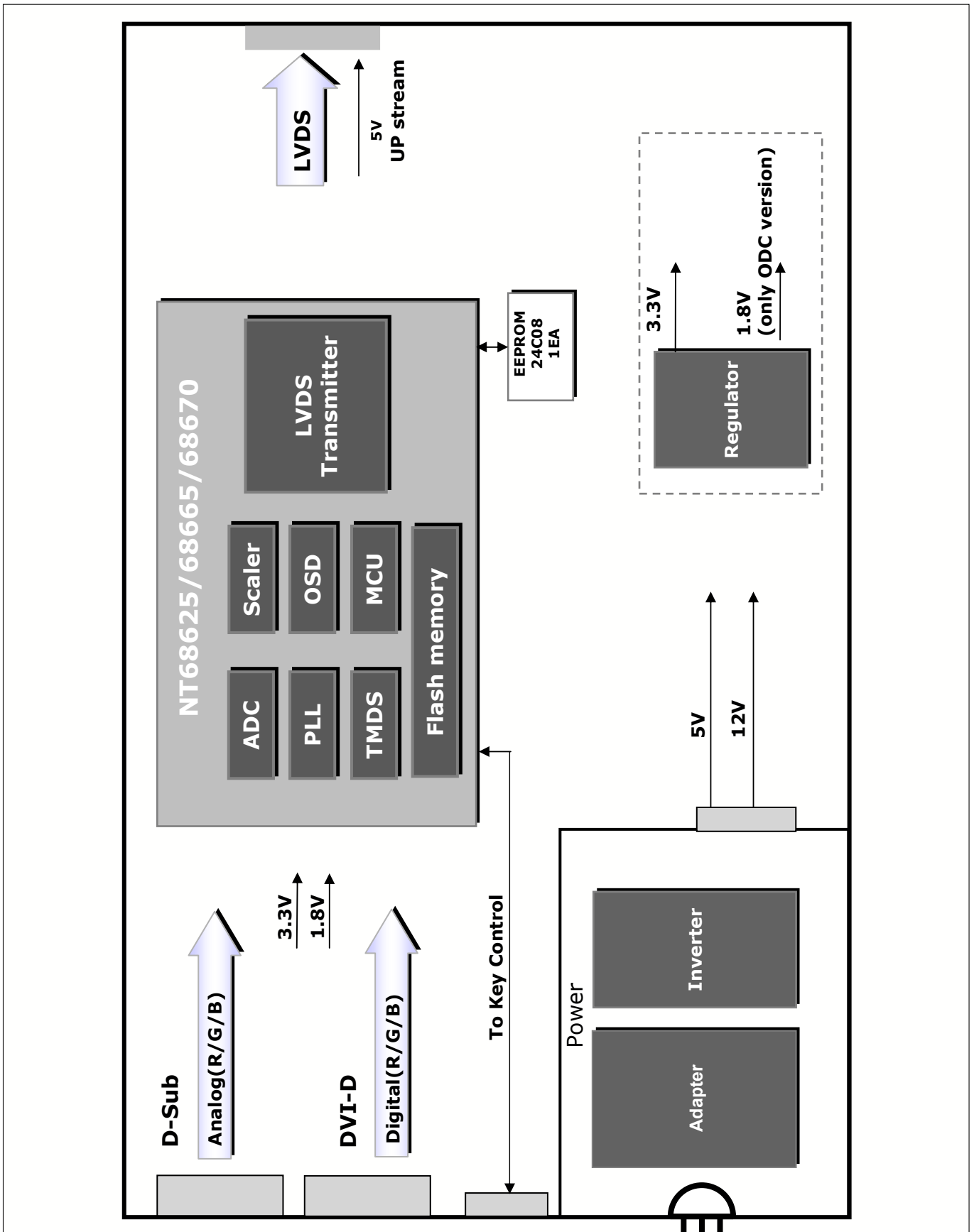

BLOCK DIAGRAM-POWER

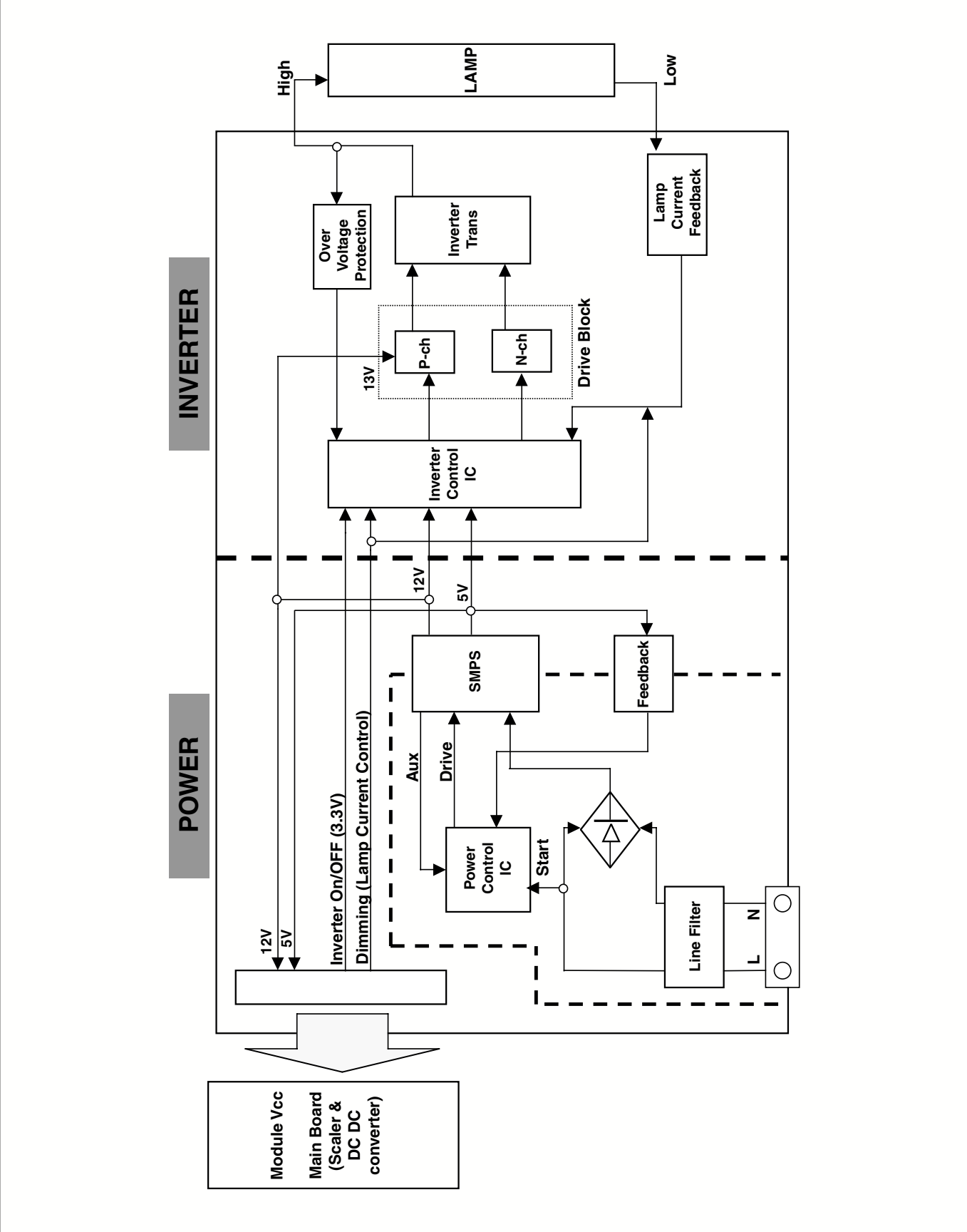

DESCRIPTION OF BLOCK DIAGRAM

1. Video Controller Part.

This part amplifies the level of video signal for the digital conversion and converts from the analog video signal to the digital video signal using a pixel clock.

The pixel clock for each mode is generated by the PLL.

The range of the pixel clock is from 25MHz to 135MHz.

This part consists of the Scaler, ADC convertor, TMDS receiver and LVDS transmitter.

The Scaler gets the video signal converted analog to digital, interpolates input to 1280 X 1024 resolution signal and outputs 8-bit R, G, B signal to transmitter.

2. Power Part.

This part consists of the one 3.3V, and one 1.8V regulators to convert power which is provided 5V in Power board.

12V is provided for inverter, 5V is provided for LCD panel.

Also, 5V is converted 3.3V and 1.8V by regulator. Converted power is provided for IC in the main board.

The inverter converts from DC12V to AC 700Vrms and operates back-light lamps of module.

3. MICOM Part.

This part is include video controller part. And this part consists of EEPROM IC which stores control data, Reset IC and the Micom.

The Micom distinguishes polarity and frequency of the H/V sync are supplied from signal cable.

The controlled data of each modes is stored in EEPROM.

LIPS Board Block Diagram

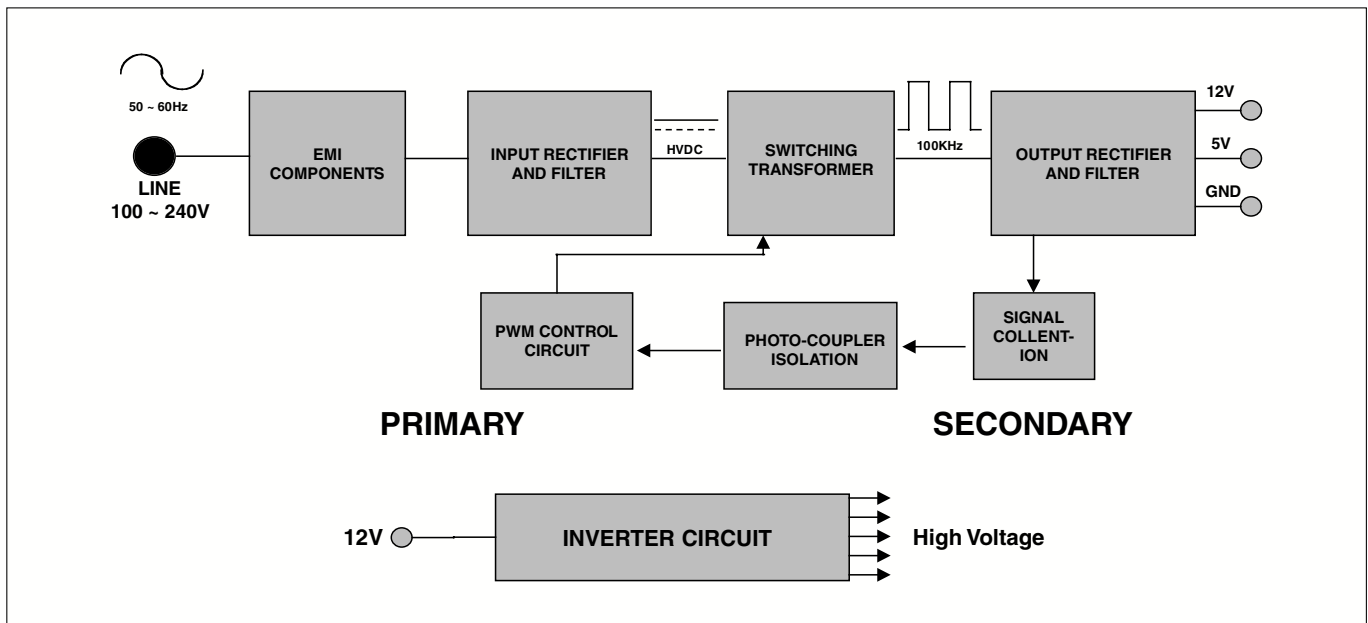

Operation description_LIPS

1. EMI components.

This part contains of EMI components to comply with global marketing EMI standards like FCC,VCCI CISPR, the circuit included a line-filter, across line capacitor and of course the primary protection fuse.

2. Input rectifier and filter.

This part function is for transfer the input AC voltage to a DC voltage through a bridge rectifier and a bulk capacitor.

3. Energy Transfer.

This part function is for transfer the primary energy to secondary through a power transformer.

4. Output rectifier and filter.

This part function is to make a pulse width modulation control and to provide the driver signal to power switch, to adjust the duty cycle during different AC input and output loading condition to achieve the dc output stabilized, and also the over power protection is also monitor by this part.

5. Photo-Coupler isolation.

This part function is to feed back the DC output changing status through a photo transistor to primary controller to achieve the stabilized DC output voltage.

6. Signal collection.

This part function is to collect the any change from the DC output and feed back to the primary through photo transistor.

ADJUSTMENT

Windows EDID V1.0 User Manual

Operating System: MS Windows 98, 2000, XP
 Port Setup: Windows 98 => Don't need setup
 Windows 2000, XP => Need to Port Setup.

This program is available to LCD Monitor only.

1. Port Setup

- a) Copy "UserPort.sys" file to "c:\WINNT\system32\drivers" folder
- b) Run Userport.exe

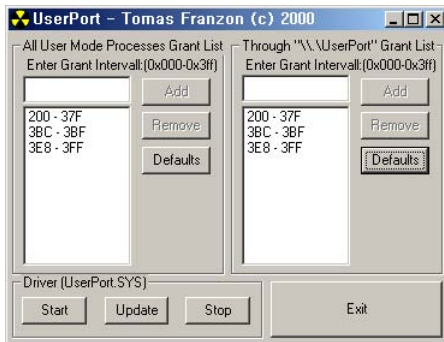

- c) Remove all default number
- d) Add 300-3FF

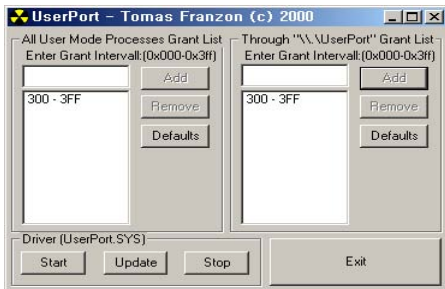

- e) Click Start button.
- f) Click Exit button.

2. EDID Read & Write

- 1) Run WinEDID.exe

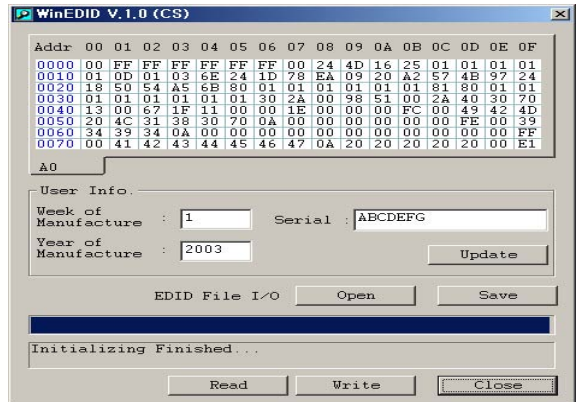

- 2) Edit Week of Manufacture, Year of Manufacture, Serial Number

- a) Input User Info Data
- b) Click "Update" button
- c) Click "Write" button

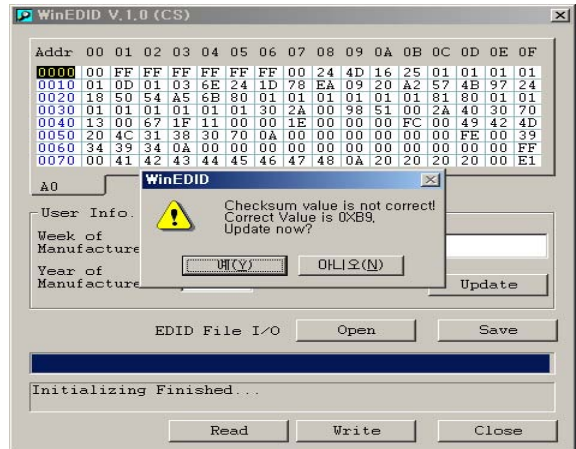

SERVICE OSD

- 1) Turn off the power switch at the front side of the display.
- 2) Wait for about 5 seconds and press MENU, POWER switch with 1 second interval.
- 3) The SVC OSD menu contains additional menus that the User OSD menu as described below.
 - a) Auto Color : W/B balance and Automatically sets the gain and offset value.
 - b) NVRAM INIT : EEPROM initialize.(24C08)
 - c) CLEAR ETI : To initialize using time.
 - d) AGING : Select Aging mode(on/off).
 - e) R/G/B-9300K : Allows you to set the R/G/B-9300K value manually.
 - f) R/G/B-6500K : Allows you to set the R/G/B-6500K value manually.
 - g) R/G/B-Offset : Allows you to set the R/G/B-Offset value manually.(Analog Only)
 - h) R/G/B-Gain : Allows you to set the R/G/B-Gain value manually.(Analog Only)
 - i) MODULE : To select applied module.

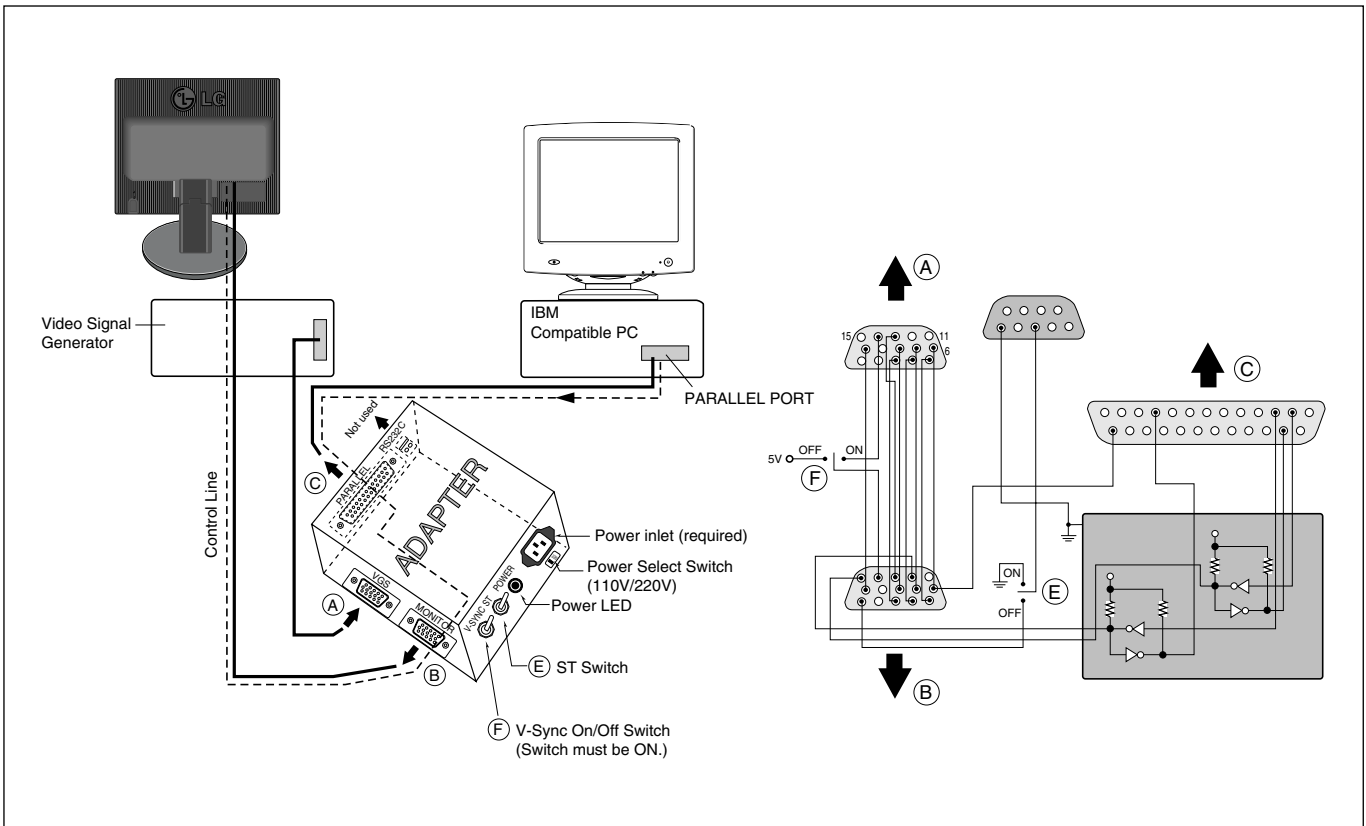
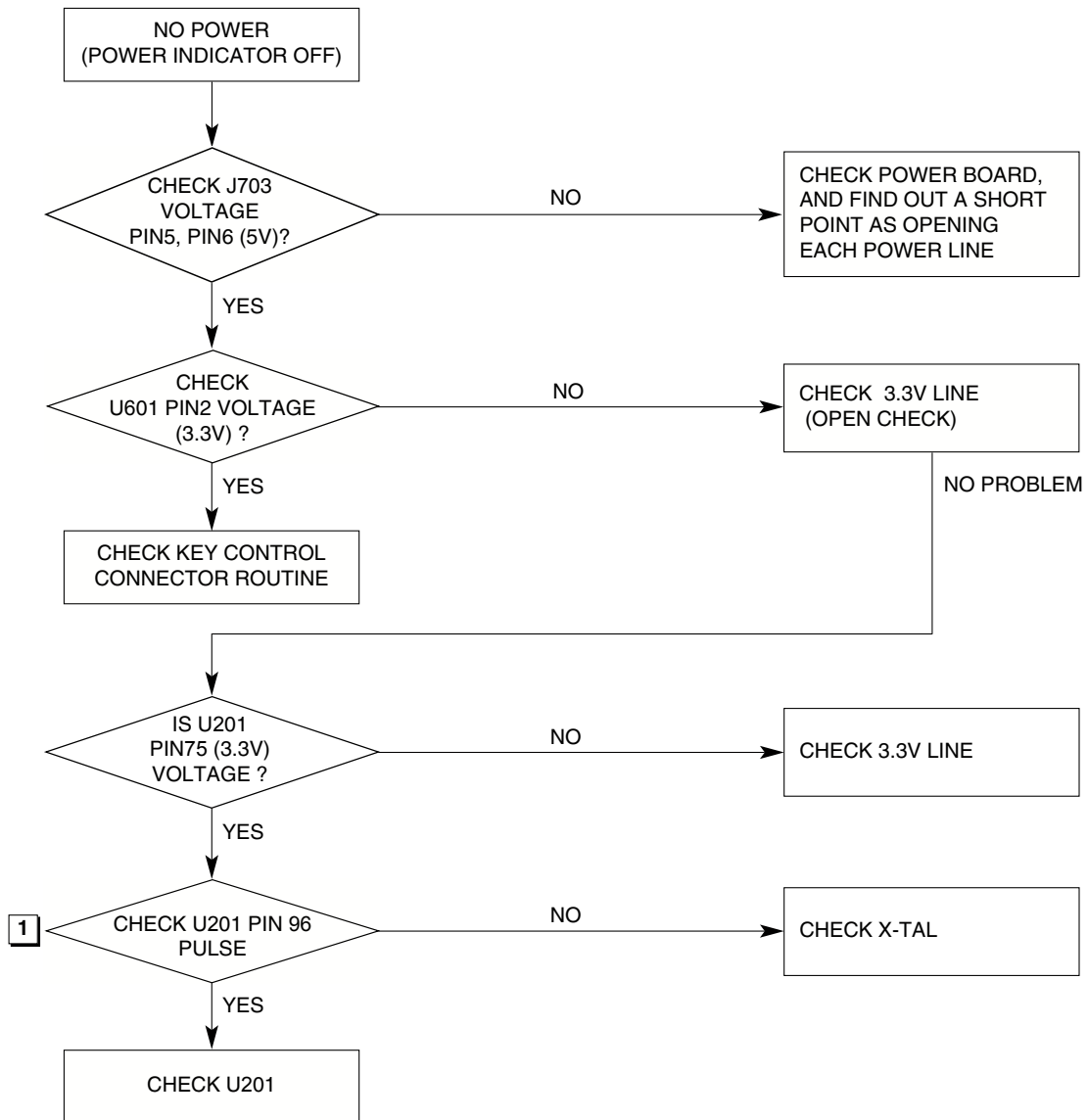

Figure 1. Cable Connection

TROUBLESHOOTING GUIDE

1. NO POWER



Waveforms

1 U201-#96

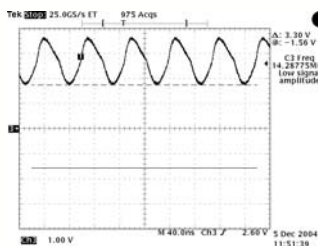

2. NO RASTER (OSD IS NOT DISPLAYED) – LIPS

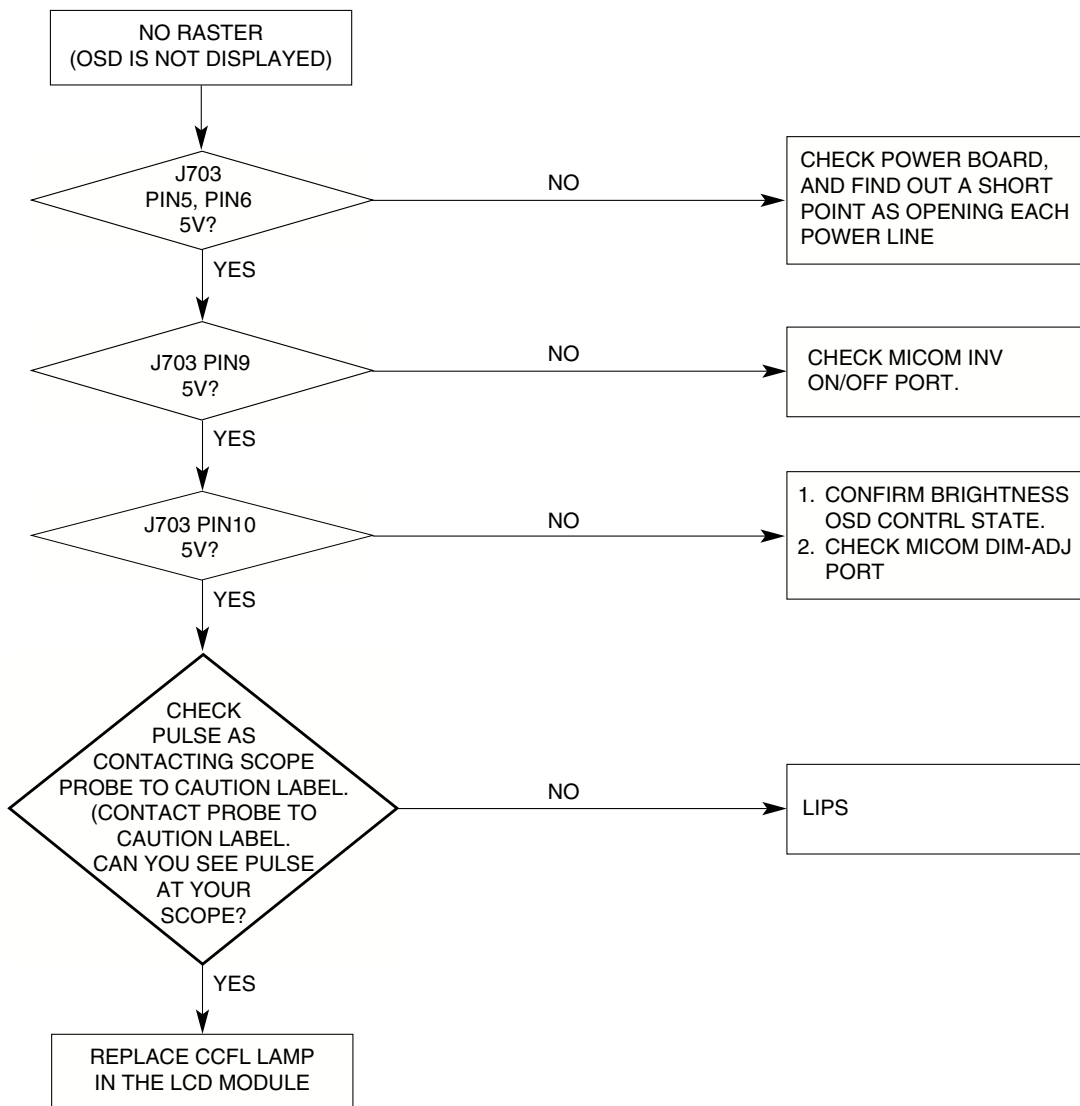

3. NO RASTER (OSD IS NOT DISPLAYED) – MSTAR

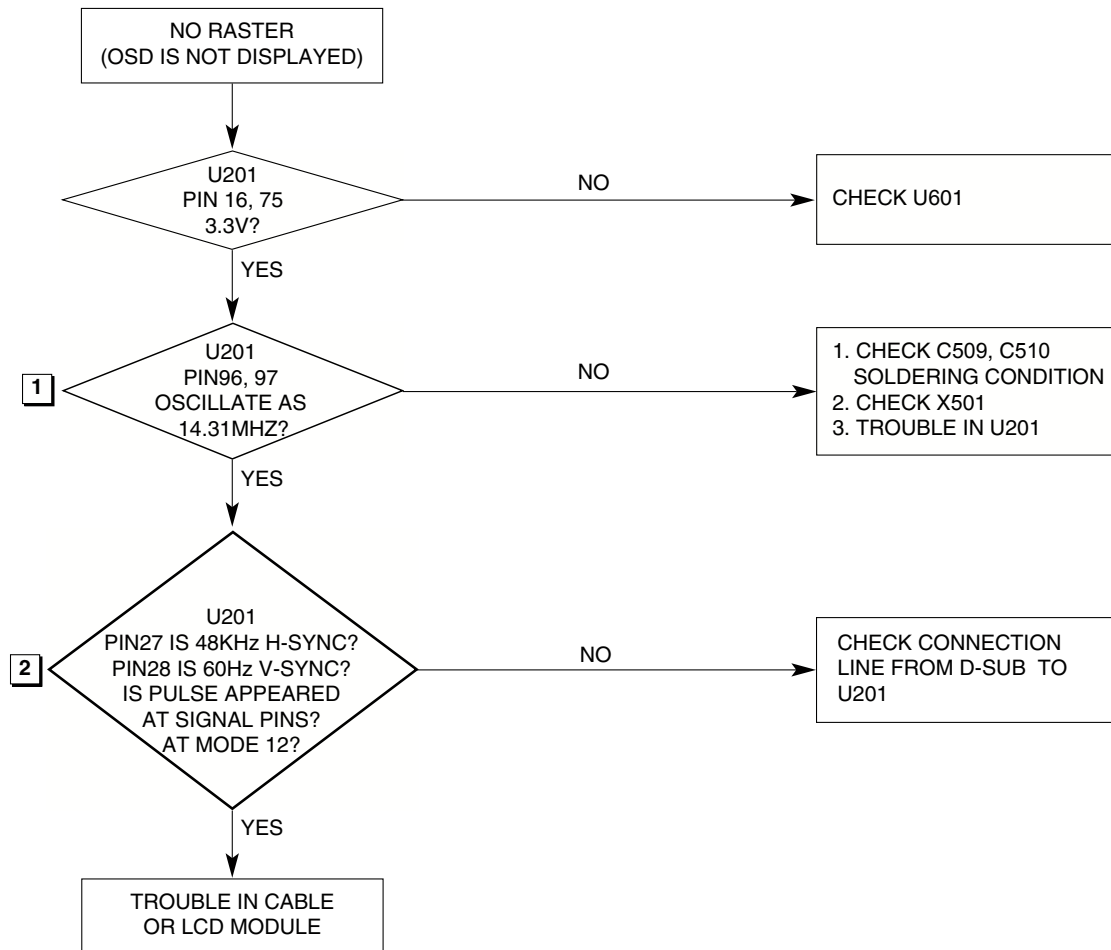

Waveforms

1 U201-#96, 97

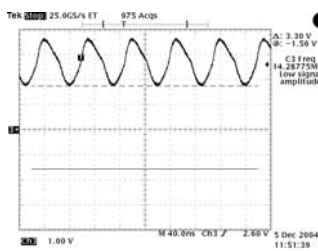

2 U201-#27 H-SYNC

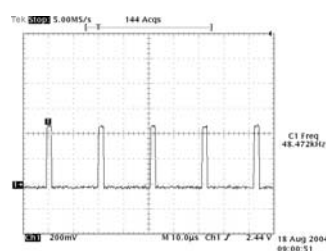

2 U201-#28 V-SYNC

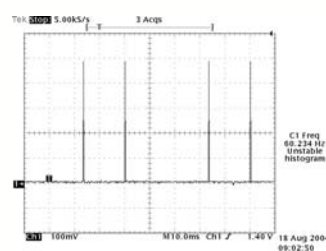

4. TROUBLE IN DPM

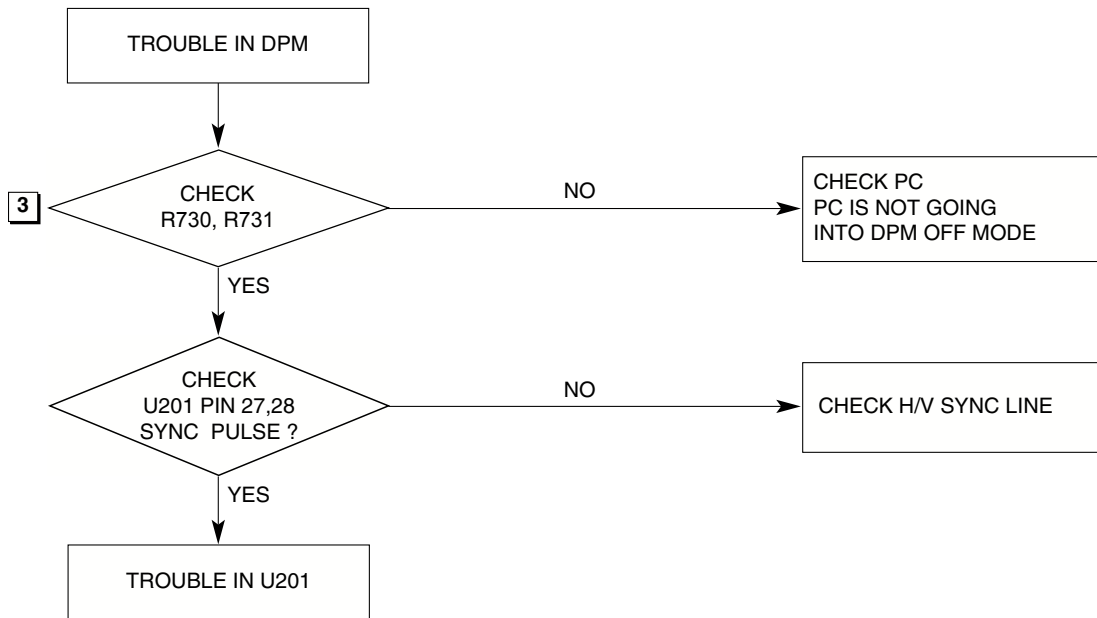

Waveforms

3 R442 H-Sync

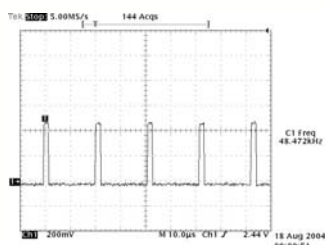

3 R443 V-Sync

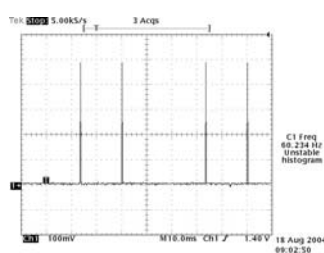

5. POWER

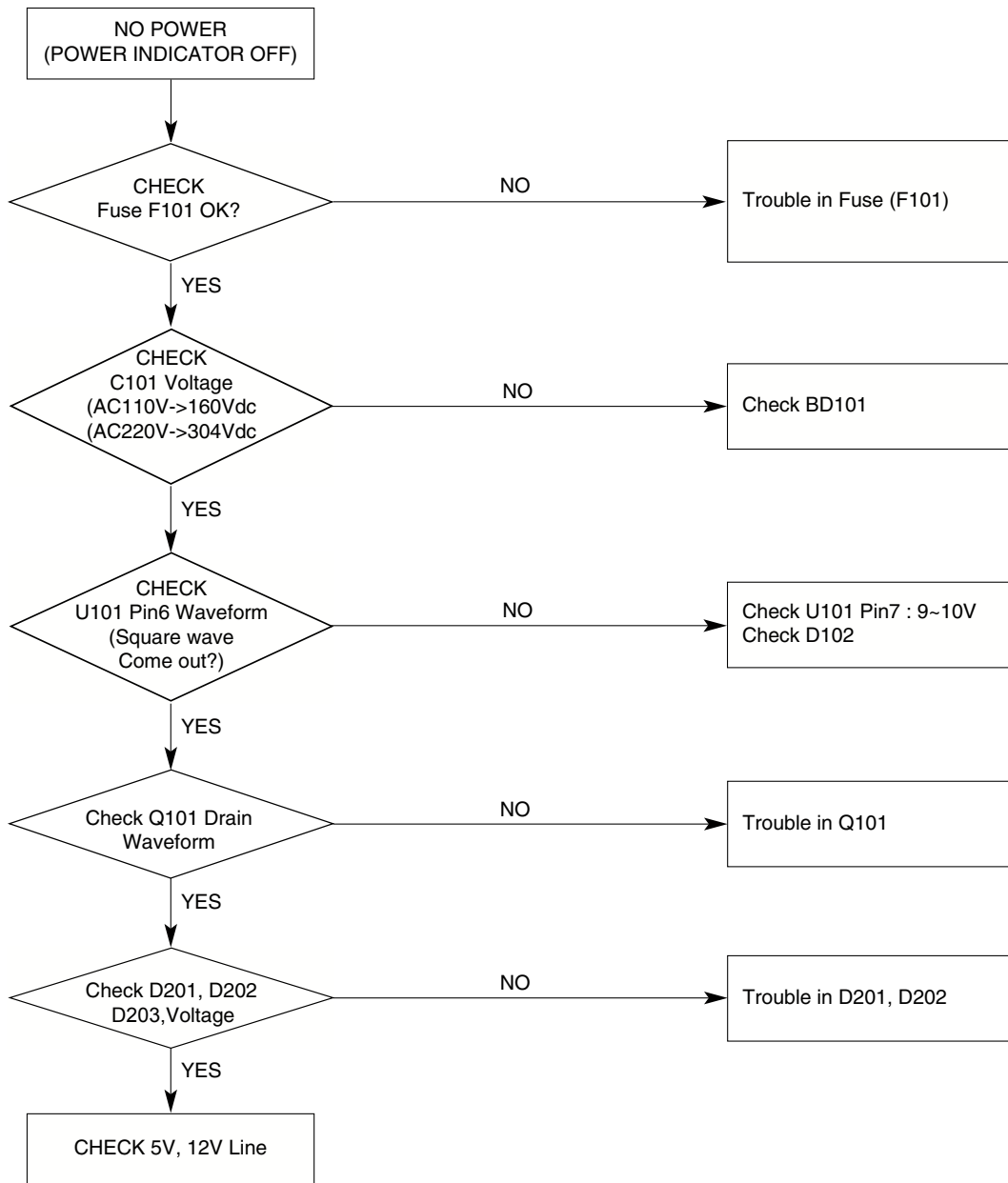

6. Raster

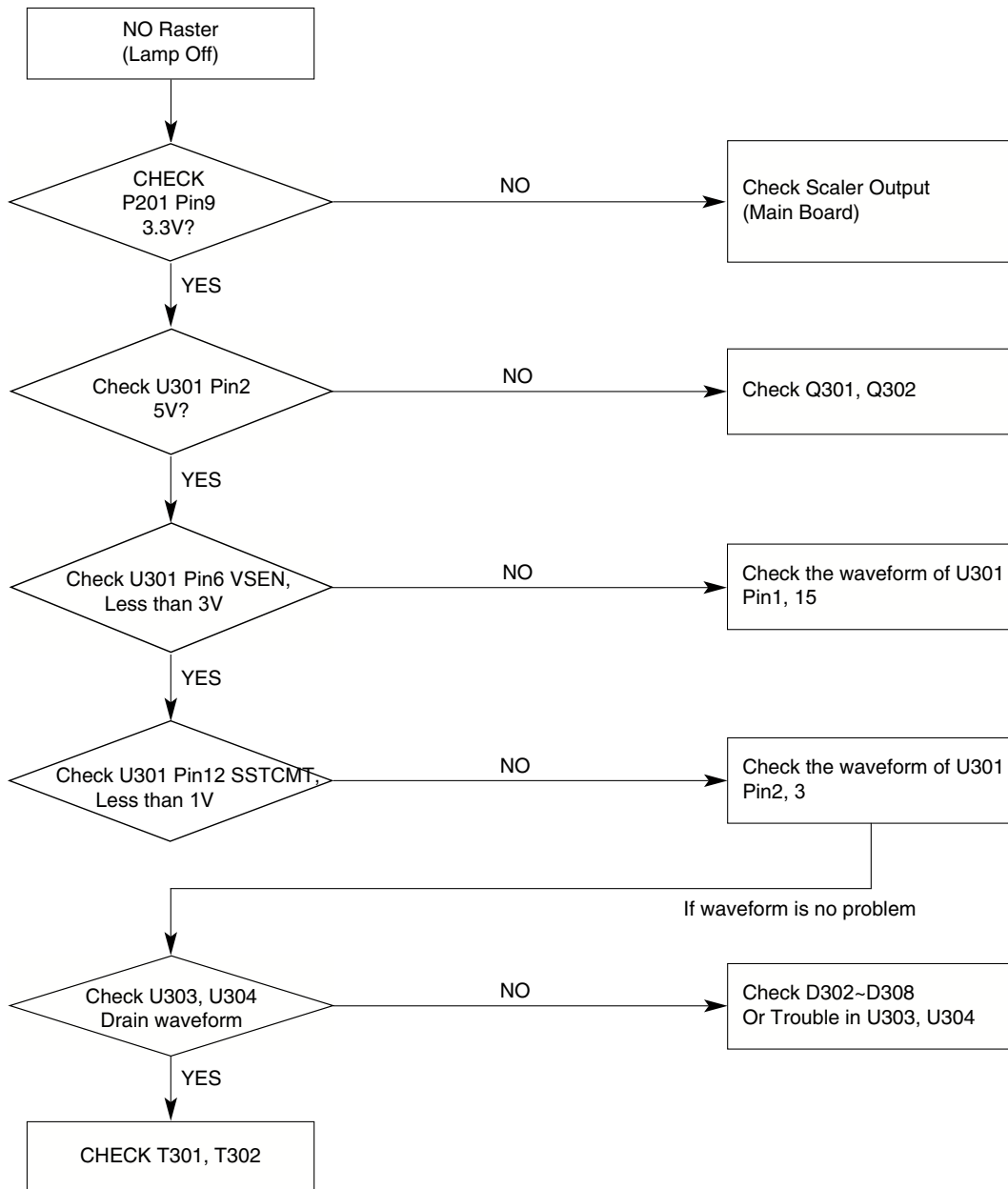

WIRING DIAGRAM

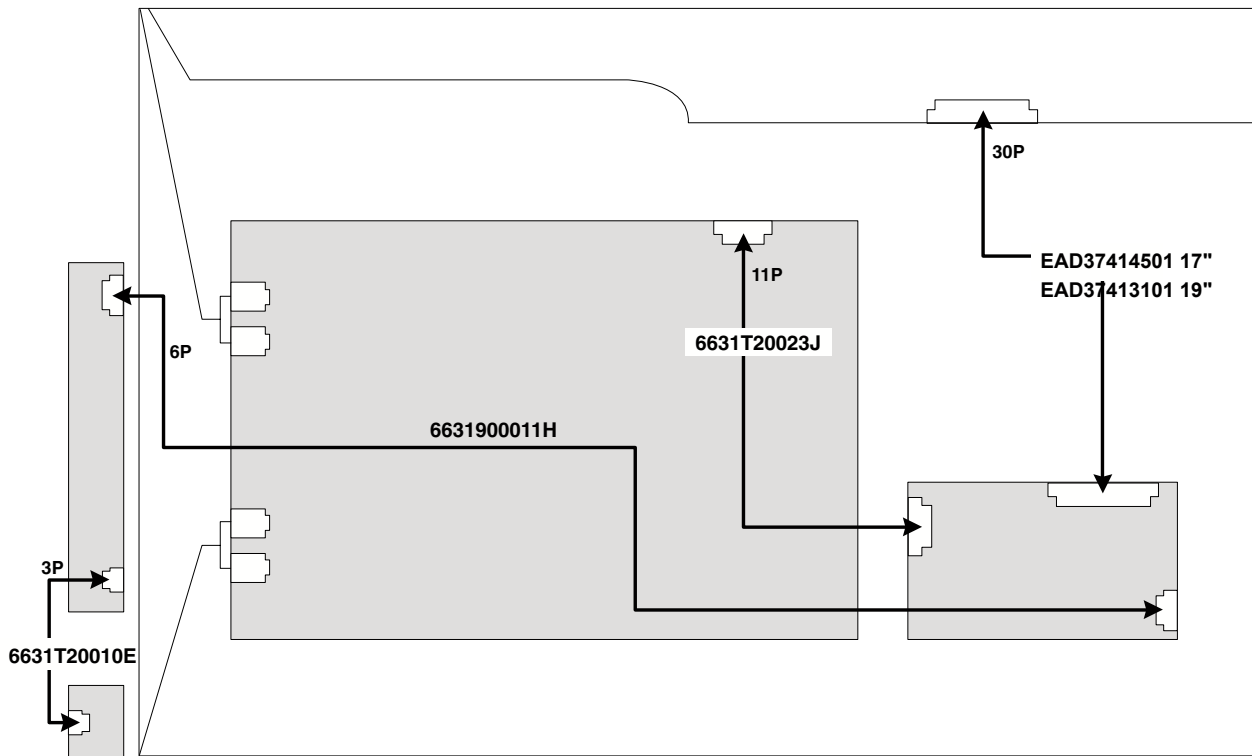



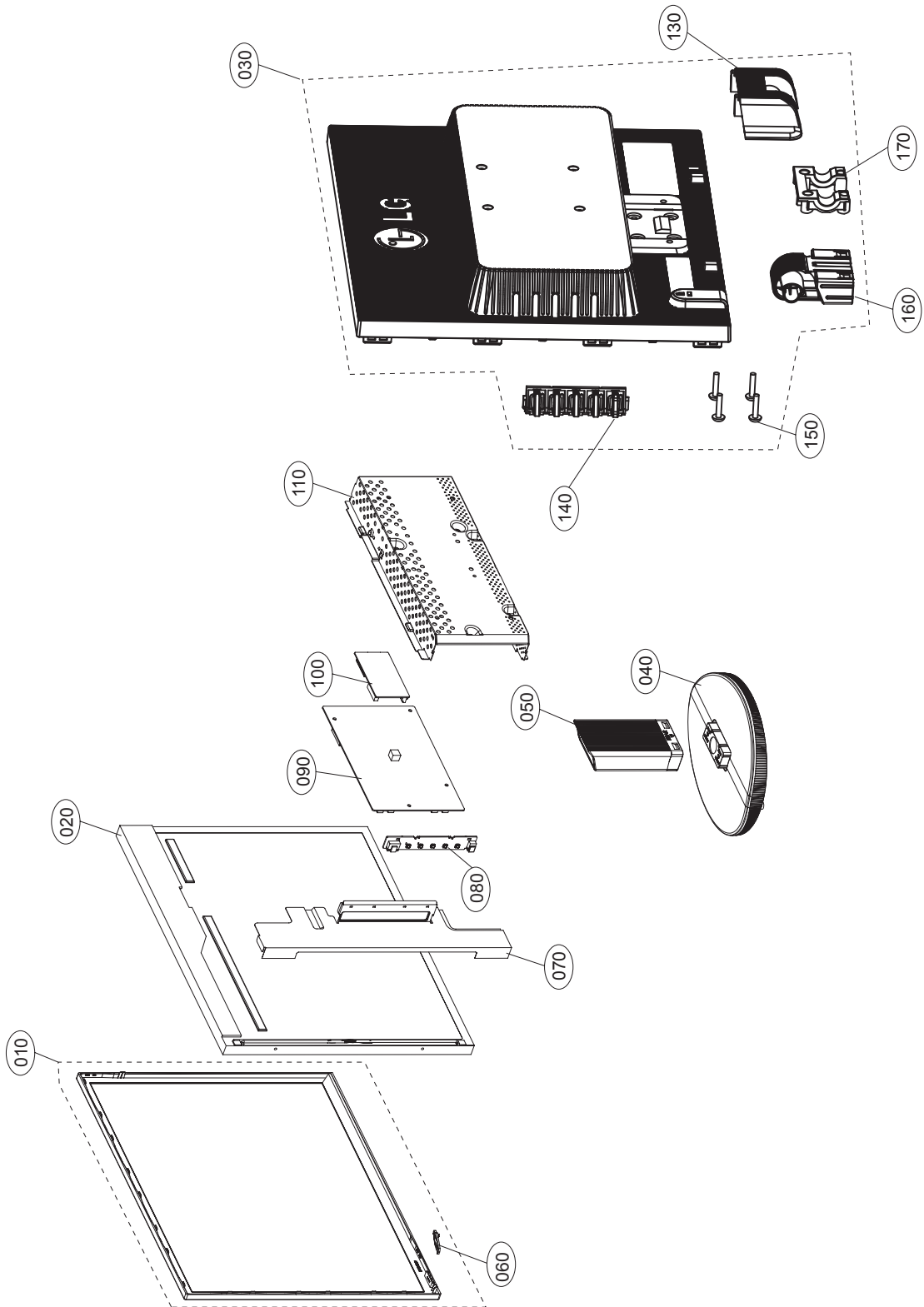



EXPLORE VIEW



EXPLODED VIEW PARTS LIST

L1753S







* Note: Safety mark 

Ref. No.		Part No.	Description
010		ABJ32220401	Cabinet Assembly,L1753 . 17" SILVER ANALOG WORLD WIDE -SILVER
		ABJ32220402	Cabinet Assembly,L1753 . 17" NEW PATTERN TEXTURE FOR 30919C0018B -BLACK
		ABJ32220444	Cabinet Assembly,L1753 . 17" NEW PATTERN TEXTURE FOR 30919C0029V -WHITE
020		EAJ34858001	LCD,Module-TFT,HT170E01-300 ZBD DRIVER 17.0INCH 1280X1024 300CD COLOR 72% 5/4 800:1 4MASK, 5ms, 160/160 BOE HYDIS TECHNOLOGY
		EAJ32176801	LCD,Module-TFT,M170EG01-VD ZBD DRIVER 17.0INCH 1280X1024 300CD COLOR 72% 5/4 800:1 5MS, 160/160, 2CH-LVDS, 4LAMP AU OPTRONICS CORP
		EAJ36378001	LCD,Module-TFT,LM170E03-TLL1 DRIVER 17.0INCH 1280X1024 300CD COLOR 72% 4/3 800:1 P5, 5ms, 160/160, TLI T-con, Lusem/Toshiba(Source/Gate), Diffuser*2+Prism*1, lamp wire 135mm LG PHILIPS LCD
		EAJ36379501	LCD,Module-TFT,LM170E03-TLL2 DRIVER 17.0INCH 1280X1024 300CD COLOR 72% 4/3 800:1 P6, 5ms, 160/160, TLI T-con, Lusem/Toshiba(Source/Gate), Diffuser x2+Prism x1, lamp(L1753T- FS.AWFOQ*N)
		EAJ36380701	LCD,Module-TFT,LM170E03-TLL3 DRIVER 17.0INCH 1280X1024 300CD COLOR 72% 4/3 800:1 P5, 5ms, 160/160, TLI T-con, Magna/Toshiba(Source/Gate), Diffuser x2+Prism x1, lamp wire 135mm LG PHILIPS LCD
		EAJ36720102	LCD,Module-TFT,CLAA170EA07P Non-ZBD DRIVER 17INCH 1280X1024 300CD COLOR 72% 4/3 700:1 5ms, 16.7M color depth, 160/160, lamp wire length 150mm CHUNGHWA PICTURE TUBES, LTD.
		EAJ36720101	LCD,Module-TFT,LM190E08-TLL2 DRIVER 19.0INCH 1280X1024 300CD COLOR 72% 4/3 800:1 P7, 5ms, 160/160, TLI T-con, Lusem/Toshiba(Source/Gate), lamp Heesung, Diffuser x2+P
030		ACQ33170001	Cover Assembly,L1753S Baikal CI model 17" Back Cover Assy Auo-VD+Analog NT Local
		ACQ33170003	Cover Assembly,L1753S Baikal CI model 17" Back Cover Assy LPL-TLL+Analog NT Local
		ACQ33170005	Cover Assembly,L1753S Baikal CI model 17" Back Cover Assy BOE 5MS-Analog NT Local
		ACQ33170008	Cover Assembly,L1753S Baikal CI model 17" L1753S Baikal CI model Back Cover Assy AUO 5ms+Analog SVC label
		ACQ33170010	Cover Assembly,L1753S Baikal CI model 17" L1753S Baikal CI model B/C ASSY LPL-TLL+Analog+SVC LABEL ND Local
		ACQ33170013	Cover Assembly,L1753S Baikal CI model 17" L1753S Baikal CI model Back Cover Assy BOE 5ms +SVC lable ND local
		ACQ33170015	Cover Assembly,L1753S Baikal CI model 17" L1753S Baikal CI model Back Cover Assy CPT 5ms +SVC lable ND local
		ACQ33170017	Cover Assembly,L1753S Baikal CI model 17" L1753S Baikal CI model Back Cover Assy CPT 5ms ND local
		ACQ33170019	Cover Assembly,L1753S Baikal CI model 17" L1753S Baikal Back Cover Assy LPL Plus White for Japan
040		AAN32608903	Base Assembly,ASSY Lx53 LM57B Lx53 PATTERN TEXTURE -WHITE
		AAN32608901	Base Assembly,ASSY Lx53 LM57B Lx53 PATTERN TEXTURE-W/W
		AAN32608906	Base Assembly,ASSY Lx53 LM57B Lx53 PATTERN TEXTURE-US
050		35509K0246D	Cover,MOLD ABS L1952 ABS L1952 NEW BODY
060		3520900038A	Indicator,LED&PRE AMP LX52 PMMA NON LED LENS
070		MGJ37924303	Plate,PRESS SPT 0.3 LAMP SPT SHIELD L1753 FOR LPL/AUO CI MODULE ND LOCCAL
080		EBR37002601	PCB Assembly,CONTROL A.I LM72A BAIKAL II 17-INCH BLUE RD 53 SERIAL
090		EBR36269401	PCB Assembly,Power,POWER T.T LM-57C BAIKAL II - -
100		EBR36999808	Main Total Assembly,MAIN M.I LM72B BAIKAL II MSTAR ANALOG RD BAIKAL II MSTAR ANALOG
110		MGJ37924107	Plate,PRESS SBHG 0.8 REAR SECC SHIELD LX53 FOR LPL/AUO CI MODULE Analog ND local
130		MCK37398801	Cover,MOLD ABS LX53 CI ABS Lx53 CI hinge cover.ND-local
140		4940900022A	Knob,MAIN 5KEY LX52 TACK KNOB
150		FAB30006311	Screw,1FTF0403321 TH + P 4MM 20MM MSWR3 FNM2
160		MCK37400101	Cover,MOLD POM Lx53 CI POM Lx53 CI hinge body,ND-local
170		MCK37399101	Cover,MOLD ABS Lx53 CI ABS Lx53 CI hinge support,ND-LOCAL

EXPLODED VIEW PARTS LIST

L1953S

* Note: Safety mark 

Ref. No.		Part No.	Description
010		ABJ32229401	Cabinet Assembly,L1953 . 19" NEW PATTERN TEXTURE FOR 30919C0019A -SILVER
		ABJ32229402	Cabinet Assembly,L1953 . 19" NEW PATTERN TEXTURE FOR 30919C0019B -BLACK
		ABJ32229443	Cabinet Assembly,L1953 . 19" NEW PATTERN TEXTURE FOR 30919C0030U -WHITE
020		EAJ36380901	LCD,Module-TFT,LM190E08-TLL2 DRIVER 19.0INCH 1280X1024 300CD COLOR 72% 4/3 800:1 P7, 5ms, 160/160, TLI T-con, Lusemi/Toshiba(Source/Gate), lamp:Heesung, Diffuser x2+Prism x1, lamp wire 160mm, depth 15.5T LG PHILIPS LCD
		or EAJ36380801	LCD,Module-TFT,LM190E08-TLL1 DRIVER 19.0INCH 1280X1024 300CD COLOR 72% 4/3 800:1 P4, 5ms, 160/160, TLI T-con, Lusemi/Toshiba(Source/Gate), lamp:Heesung, Diffuser x2+LC213x1, lamp wire 160mm, depth 15.5T LG PHILIPS LCD
		or EAJ36381001	LCD,Module-TFT,LM190E08-TLL3 DRIVER 19.0INCH 1280X1024 300CD COLOR 72% 4/3 800:1 P4, 5ms, 160/160, TLI T-con, Magnal/Toshiba(Source/Gate), lamp:Heesung, Diffuser x2+LC213 x1, lamp wire 160mm, depth 15.5T LG PHILIPS LCD
		6304FHS014C	LCD,Module-TFT,HSD190ME13-D10 DRIVER 19INCH 1280X1024 300CD COLOR 72% 4/3 700:1 - HANNSTAR DISPLAY CORPORATION
		or 6304FHS014B	LCD,Module-TFT,HSD190ME13-D10(700VS1) DRIVER 19INCH 1280X1024 300CD COLOR 72% 4/3 700:1 - HANNSTAR DISPLAY CORPORATION
		EAJ32176101	LCD,Module-TFT,M190EG02-V4 ZBD DRIVER 19.0INCH 1280X1024 300CD COLOR 72% 5/4 800 VS 1 5MS, 160/160, 2CH-LVDS, 4LAMP AU OPTRONICS CORP
		or EAJ32176102	LCD,Module-TFT,M190EG02-V4 NON-ZBD DRIVER 19.0INCH 1280X1024 300CD COLOR 72% 5/4 800 VS 1 5MS, 160/160, 2CH-LVDS, 4LAMP, NON-ZBD AU OPTRONICS CORP
030		ACQ33173101	Cover Assembly,L1953S Baikal CI model 19" Back Cover Assy Auo-V4-Analog NT
		ACQ33173103	Cover Assembly,L1953S Baikal CI model 19" Back Cover Assy LPL-TLL Analog NT
		ACQ33173107	Cover Assembly,L1953S Baikal CI model 19" L1953S Baikal CI Back Cover Assy HSD ND LOCAL
		ACQ33173109	Cover Assembly,L1953S Baikal CI model 19" L1953S Baikal CI Back Cover Assy AUO VD+SVC LABEL ND LOCAL
		ACQ33173111	Cover Assembly,L1953S Baikal CI model 19" L1953S Baikal CI Back Cover Assy LPL CI MODULE+ SVC LABLE ND LOCAL
		ACQ33173113	Cover Assembly,L1953S Baikal CI model 19" L1953S Baikal CI Back Cover Assy HSD +SVC LABLE ND LOCAL
		ACQ33173115	Cover Assembly,L1953S Baikal CI model 19" L1953S baikal Back Cover Assy LPL plus module White for Japan
040		AAN32608903	Base Assembly,ASSY Lx53 LM57B Lx53 PATTERN TEXTURE -WHITE
		AAN32608901	Base Assembly,ASSY Lx53 LM57B Lx53 PATTERN TEXTURE-W/W
		AAN32608906	Base Assembly,ASSY Lx53 LM57B Lx53 PATTERN TEXTURE-US
050		35509K0246D	Cover,MOLD ABS L1952 ABS L1952 NEW BODY
060		3520900038A	Indicator,LED&PRE AMP LX52 PMMA NON LED LENS
070		MGJ37924303	Plate,PRESS SPT 0.3 LAMP SPT SHIELD L1753 FOR LPL/AUO CI MODULE ND LOCCAL
080		EBR37002601	PCB Assembly,CONTROL A.I LM72A BAIKAL II 17-INCH BLUE RD 53 SERIAL
090		EBR36269401	PCB Assembly,Power,POWER T.T LM-57C BAIKAL II - -
100		EBR36999808	Main Total Assembly,MAIN M.I LM72B BAIKAL II MSTAR ANALOG RD BAIKAL II MSTAR ANALOG
110		MGJ37924107	Plate,PRESS SBHG 0.8 REAR SECC SHIELD LX53 FOR LPL/AUO CI MODULE Analog ND local
130		MCK37398801	Cover,MOLD ABS LX53 CI ABS Lx53 CI hinge cover.ND-local
140		4940900022A	Knob,MAIN 5KEY LX52 TACK KNOB
150		FAB30006311	Screw,1FTF0403321 TH + P 4MM 20MM MSWR3 FNM2
160		MCK37400101	Cover,MOLD POM Lx53 CI POM Lx53 CI hinge body,ND-local
170		MCK37399101	Cover,MOLD ABS Lx53 CI ABS Lx53 CI hinge support,ND-LOCAL

SCHEMATIC DIAGRAM

1. SCALER

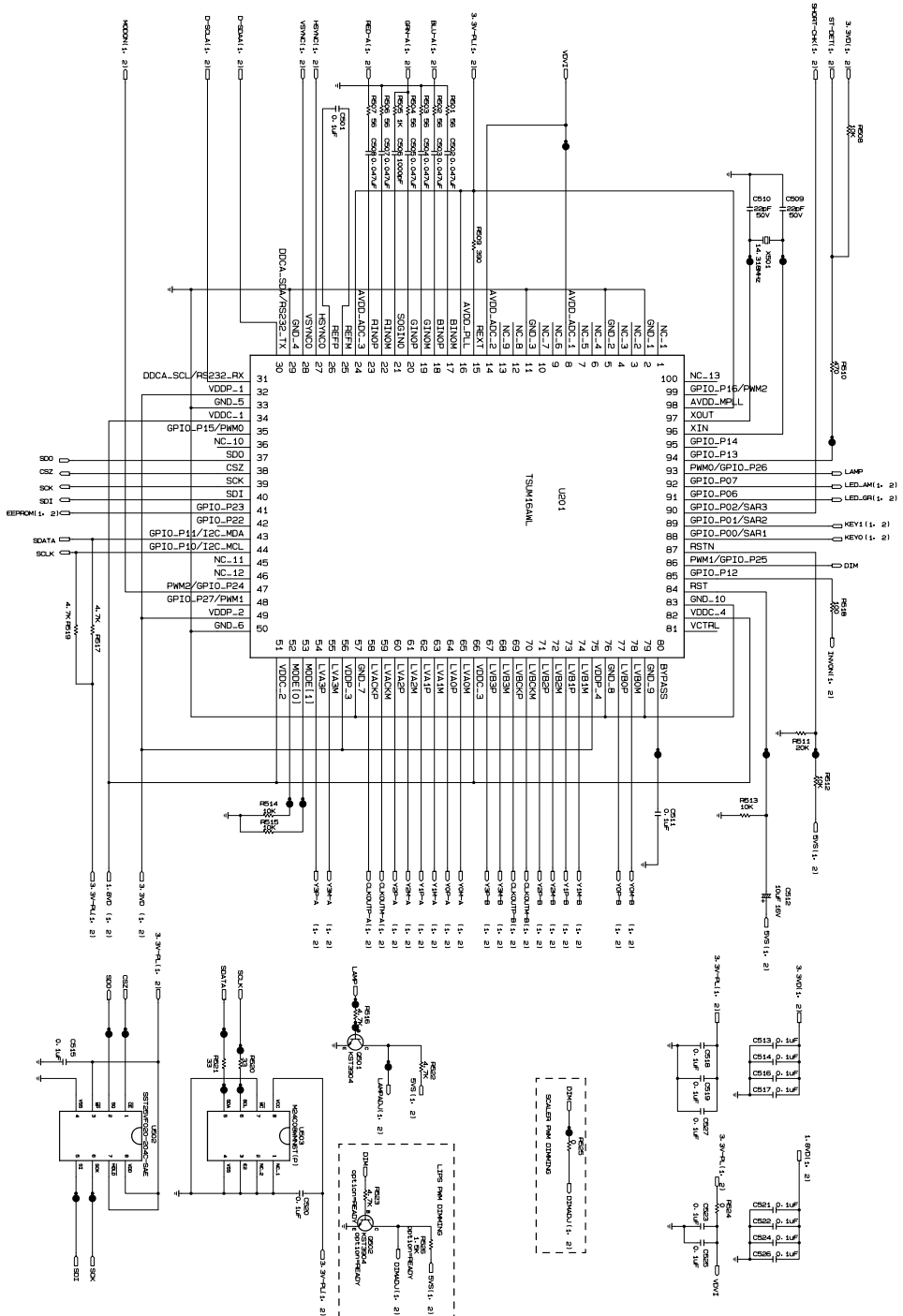

2. POWER & WAFER

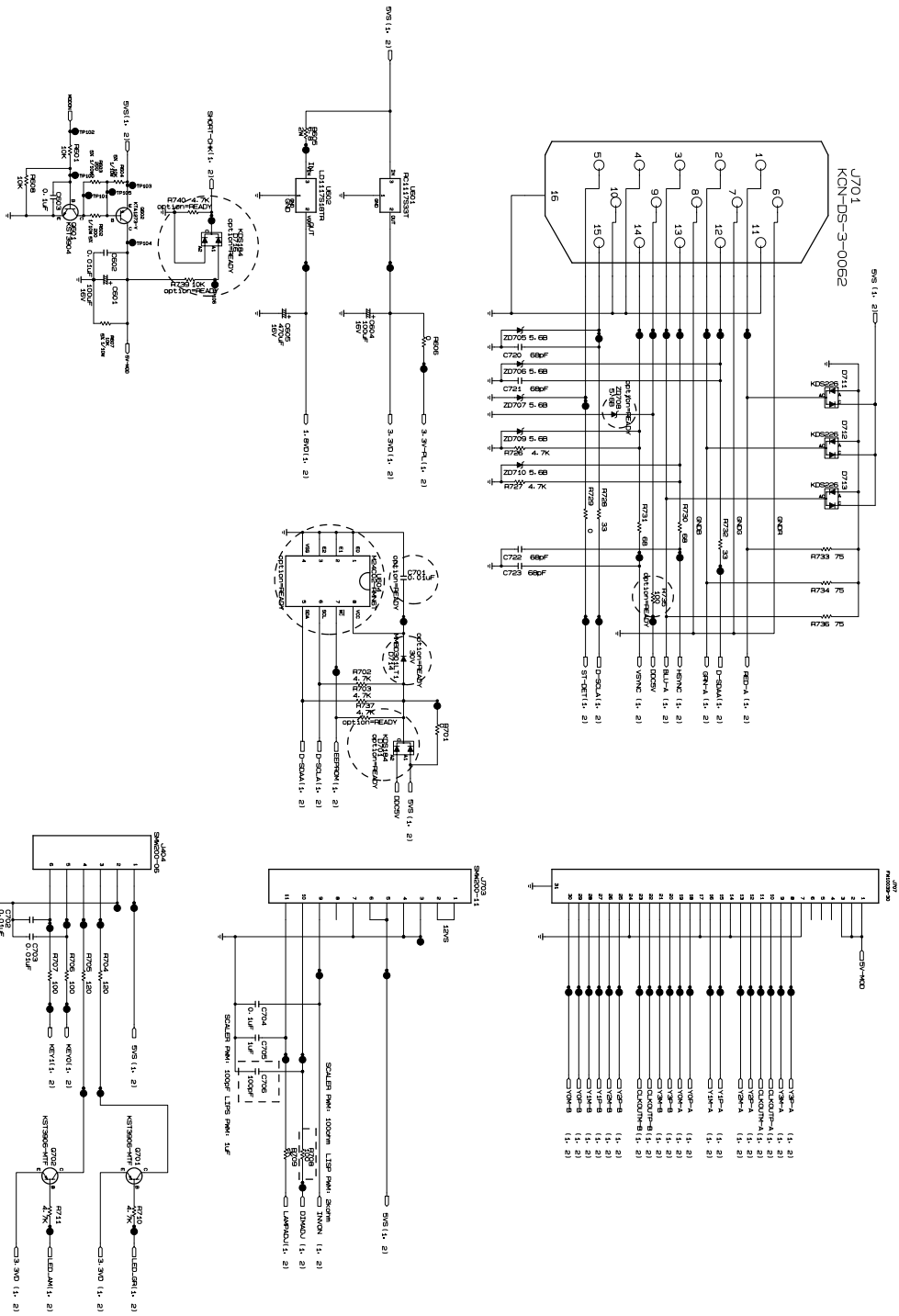

3. INVERTER

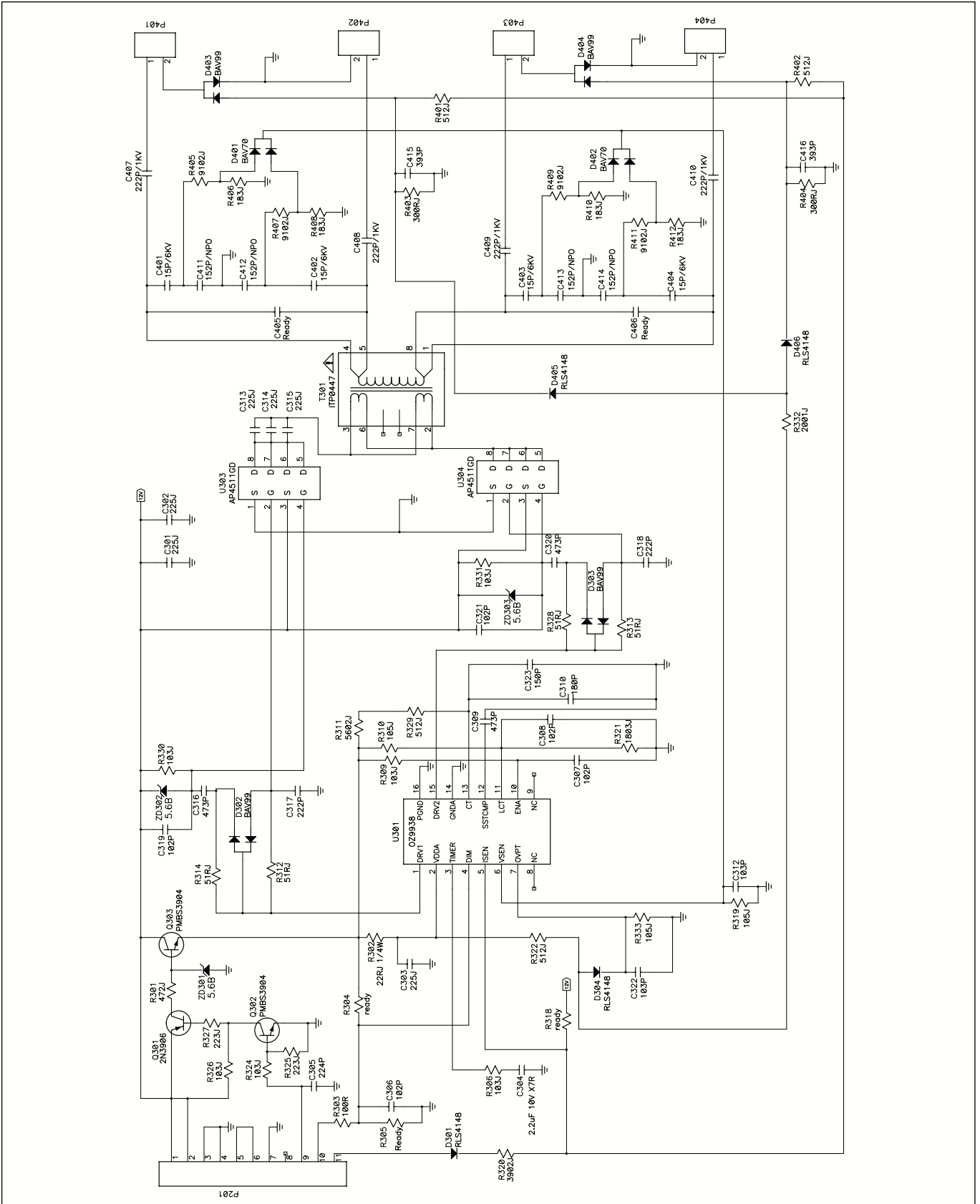

4. POWER

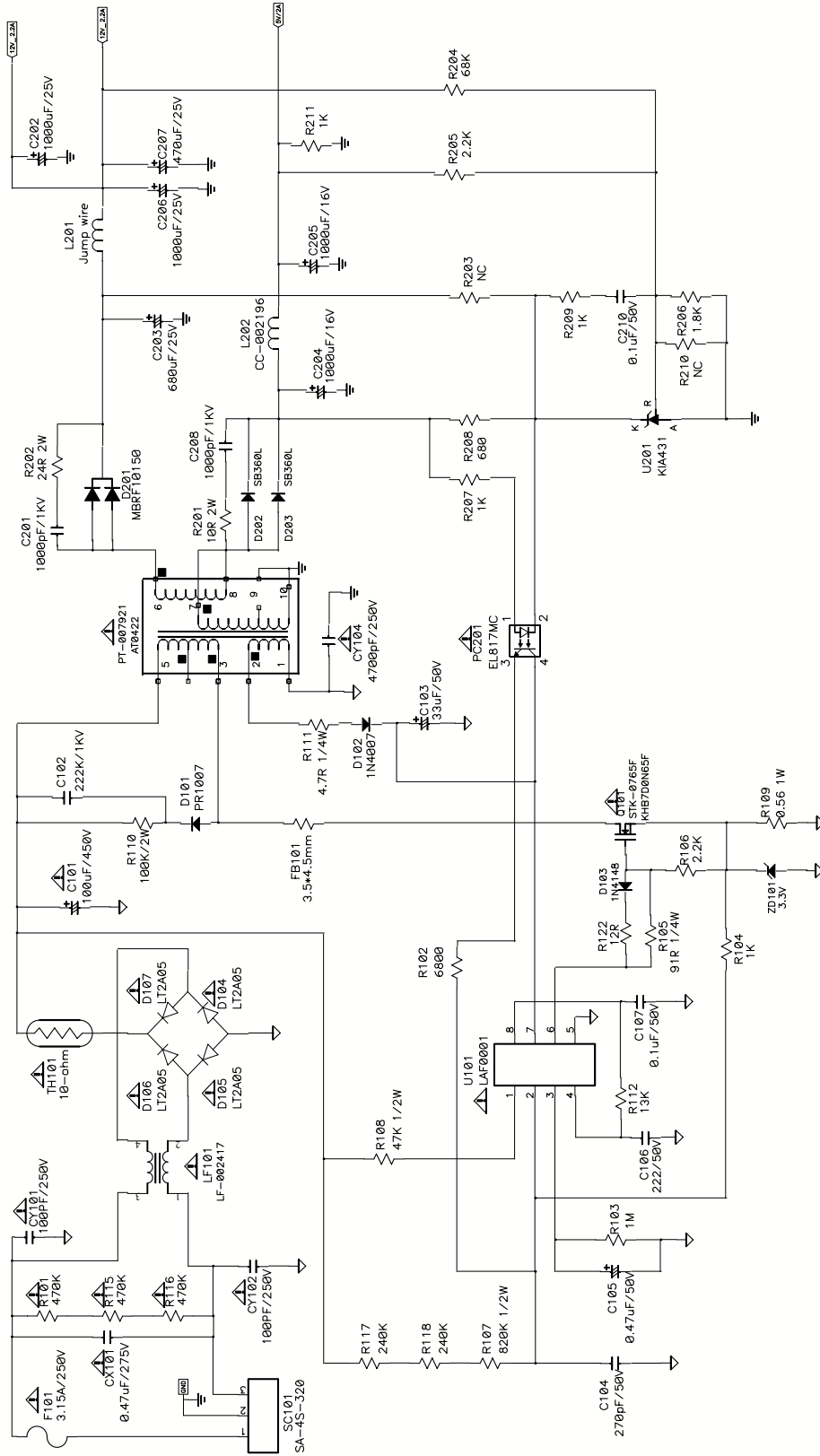



P/NO : MFL30290843

May. 2007
Printed in China