

Ultra High Speed Switching Application

- Low forward voltage : $V_{F(3)} = 0.92V$ (typ.)
- Fast reverse recovery time : $t_{rr} = 1.6ns$ (typ.)
- Small total capacitance : $C_T = 2.2pF$ (typ.)
- We declare that the material of product compliance with RoHS requirements.

L1SS181LT1G

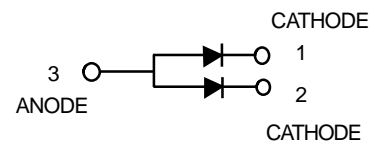
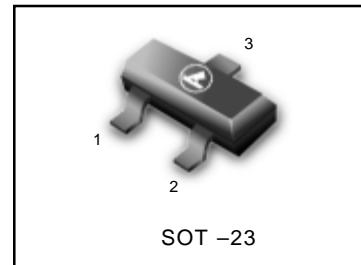

Driver Marking

L1SS181LT1G = A3

Maximum Ratings ($T_A = 25^\circ C$)

Characteristic	Symbol	Rating	Unit
Maximum (peak) reverse voltage	V_{RM}	85	V
Reverse voltage	V_R	80	V
Maximum (peak) forward current	I_{FM}	300 *	mA
Average forward current	I_O	100 *	mA
Surge current (10ms)	I_{FSM}	2 *	A
Power dissipation	P	150	mW
Junction temperature	T_j	125	$^\circ C$
Storage temperature range	T_{stg}	-55~+125	$^\circ C$

* : Unit rating. Total rating = Unit rating \times 1.5.

Electrical Characteristics ($T_A = 25^\circ C$)

Characteristic	Symbol	Test Circuit	Test Condition	Min	Typ.	Max	Unit
Forward voltage	$V_{F(1)}$	—	$I_F = 1mA$	—	0.61	—	V
	$V_{F(2)}$	—	$I_F = 10mA$	—	0.74	—	
	$V_{F(3)}$	—	$I_F = 100mA$	—	0.90	1.20	
Reverse current	$I_{R(1)}$	—	$V_R = 30V$	—	—	0.1	μA
	$I_{R(2)}$	—	$V_R = 80V$	—	—	0.5	
Total capacitance	C_T	—	$V_R = 0, f = 1MHz$	—	2.2	4.0	pF
Reverse recovery time	t_{rr}	—	$I_F = 10mA$ (Fig.5)	—	1.6	4.0	ns

Ordering Information

Device	Marking	Shipping
L1SS181LT1G	A3	3000/Tape&Reel
L1SS181LT3G	A3	10000/Tape&Reel

L1SS181LT1G

Electrical characteristic curves

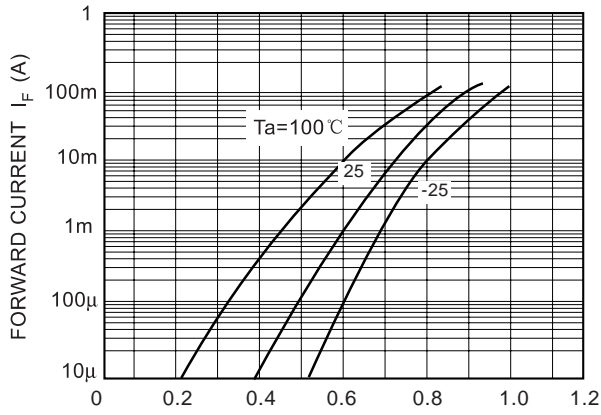

Fig.1 FORWARD VOLTAGE V_F (V)

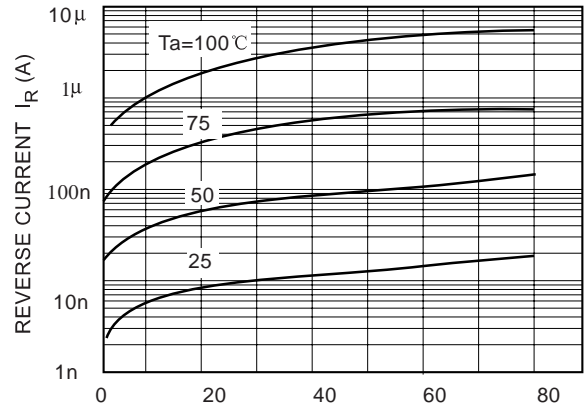

Fig.2 REVERSE VOLTAGE V_R (V)

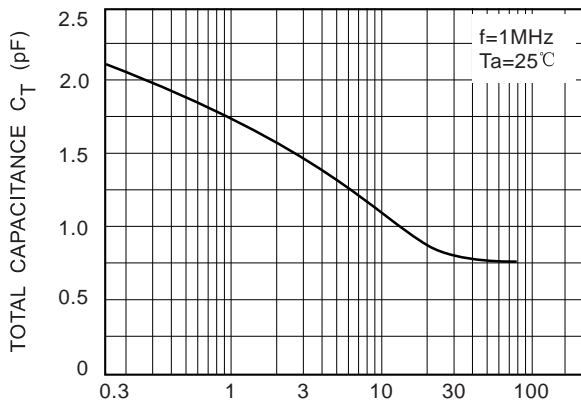

Fig.3 REVERSE VOLTAGE V_R (V)

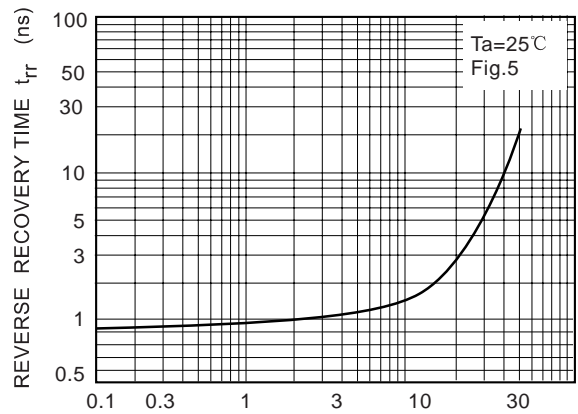

Fig.4 FORWARD CURRENT I_F (mA)

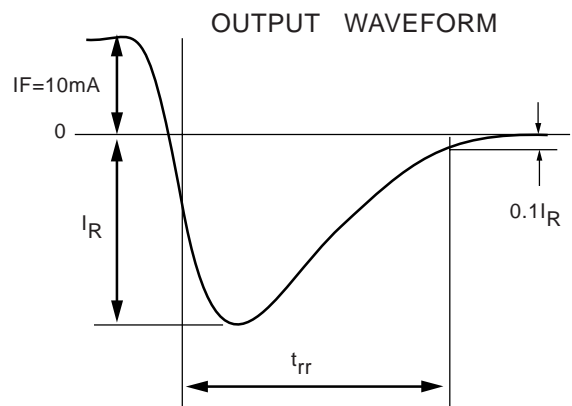
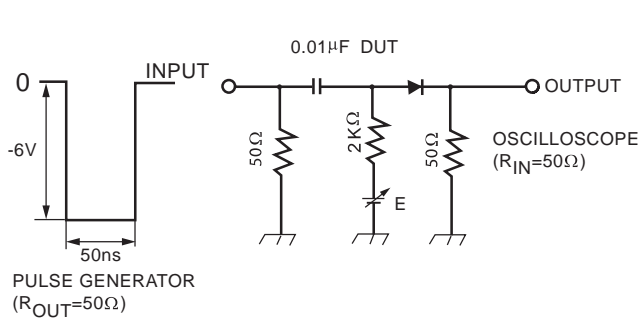

Fig.5 Reverse recovery time (t_{rr}) test circuit

L1SS181LT1G

SOT-23

NOTES:

1. DIMENSIONING AND TOLERANCING PER ANSI Y14.5M,1982
2. CONTROLLING DIMENSION: INCH.

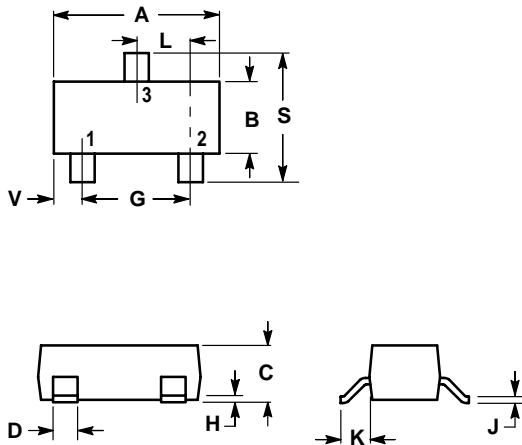

DIM	INCHES		MILLIMETERS	
	MIN	MAX	MIN	MAX
A	0.1102	0.1197	2.80	3.04
B	0.0472	0.0551	1.20	1.40
C	0.0350	0.0440	0.89	1.11
D	0.0150	0.0200	0.37	0.50
G	0.0701	0.0807	1.78	2.04
H	0.0005	0.0040	0.013	0.100
J	0.0034	0.0070	0.085	0.177
K	0.0140	0.0285	0.35	0.69
L	0.0350	0.0401	0.89	1.02
S	0.0830	0.1039	2.10	2.64
V	0.0177	0.0236	0.45	0.60

- PIN 1. BASE
 2. EMITTER
 3. COLLECTOR

