

# HAMAMATSU

PATENT

## SUPER-QUIET MERCURY-XENON LAMPS

DEEP UV LIGHT SOURCE  
FOR PRECISION MEASUREMENT



A Mercury-Xenon Lamp is a special lamp designed to provide high radiant energy in the ultraviolet region. Since an optimum mixture of mercury and xenon gas is enclosed, this lamp offers the characteristics of both Xenon lamps and super-high-pressure Mercury lamps. For example, the spectral distribution of a Mercury-Xenon Lamp includes a continuous spectrum from ultraviolet to infrared of the xenon gas and strong mercury line spectra in the ultraviolet to visible range. In comparison to super-high-pressure mercury lamps, the radiant spectrum in the ultraviolet region is higher in intensity and sharper in width. The Mercury-Xenon Lamp also features instantaneous starting and restarting, which are difficult with super-high-pressure mercury lamps, thus making them an excellent choice as ultraviolet light sources.

Conventional Mercury-Xenon Lamps have a shortcoming in that the arc point fluctuates and moves gradually with operating time as a result of the cathode erosion. Hamamatsu has used its many years of experience and expertise in the fields of photonics to produce Super-Quiet (SQ) Mercury-Xenon Lamps. The Hamamatsu SQ Mercury-Xenon Lamps employ a specially developed cathode which has minimized the cathode erosion, thus allowing extremely high stability and long life.

### FEATURES

- **High stability**
  - Fluctuation (p-p) ..... 1.0 % (Typ.)  
2.0 % (Max.)
  - Drift .....  $\pm 0.5$  % /h (Typ.)
- **Long life**
  - Guaranteed life ..... 500 h to 1000 h
  - Average life ..... 1000 h to 2000 h
- **Virtually no arc point shift ..... 0.1 mm (Max.)**
- **Instantaneous starting and restarting**
- **High intensity in deep UV region**
- **Point light source, High luminance**

### APPLICATIONS

- **Wafer Inspection**
- **Semiconductor annealing**
- **Fluorescent microscope**
- **Blood analyzer**
- **UV curing for epoxies, etc.**
- **Interferometer, Refractometer**
- **Microfilm enlarger**

# SUPER-QUIET MERCURY-XENON LAMPS

## CONSTRUCTION AND OPERATION

Figure 1 shows the construction of the lamp. The lamp has same shape as that of the conventional Xenon short-arc lamp or super-high-pressure mercury lamp with two electrodes of cathode and anode. The electrodes face each other in an oval glass bulb which is filled with a certain amount of mercury and high purity xenon gas under several MPa of pressure.

Figure 1: Construction of Lamp

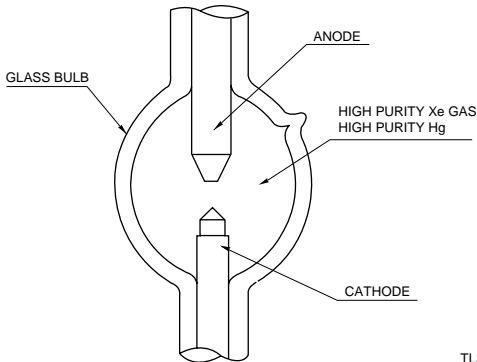

TLSXC0033EA

As for operation, Mercury-Xenon Lamps utilize the principle of light emission by arc discharge. This type of lamp must be installed either vertically with the anode above the cathode or horizontally. Initially an arc discharge triggers the lamp to start its emission. The lamp maintains stable operation via an applied dc voltage. The light emission from the arc discharge has strong line spectra ranging from ultraviolet to infrared radiation. After the lamp is switched on, emission of light from the xenon gas occurs. This is accompanied by efficient vaporization of the mercury, and emission of light for the mercury spectrum. It takes several minutes for the radiant intensity to reach the maximum value, as the gas pressure inside the bulb increases after the bulb is lit up until it reaches a thermal equilibrium. The gas pressure during operation is approximately 3 times higher than that when the lamp is not operated. Figure 2 shows the typical temperature distribution of a lamp bulb after thermal equilibrium.

Figure 2: Typical Temperature Distribution of a Lamp Bulb (at Vertical Operation)

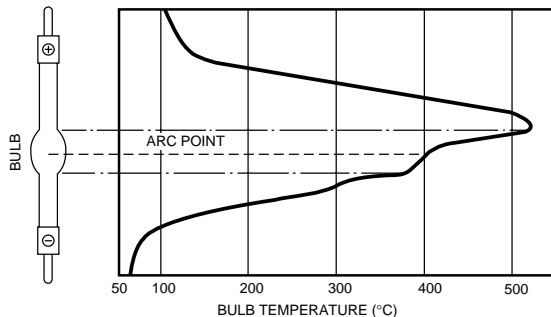

TLSXB0007EA

## STABILITY OF ARC (FLUCTUATION)

The elimination of arc fluctuation has been an important issue for Mercury-Xenon Lamp users in precision light measuring applications. Hamamatsu has studied this "fluctuation" carefully, and ascertained that it is mostly an irregular movement of the arc point caused by a lack of electrons emitted from the cathode. The Hamamatsu SQ Mercury-Xenon Lamp has solved this problem by incorporating a high-performance cathode especially developed for this purpose.

## MOVEMENT OF ARC POINT

Conventional Mercury-Xenon Lamps have a shortcoming in that their arc point can move gradually as a result of cathode erosion during normal operation. The SQ Mercury-Xenon Lamp uses a specially developed, durable cathode which shows negligible erosion with operating time. Therefore, once the optical system is set up, it is no more necessary to adjust it over the operating life of the lamp.

Figure 3: Comparison of Cathode Erosion

### Super-Quiet Mercury-Xenon Lamps

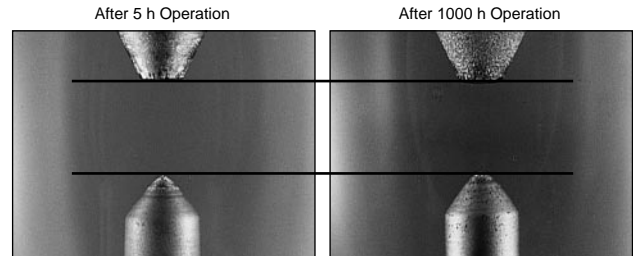

### Conventional Lamp

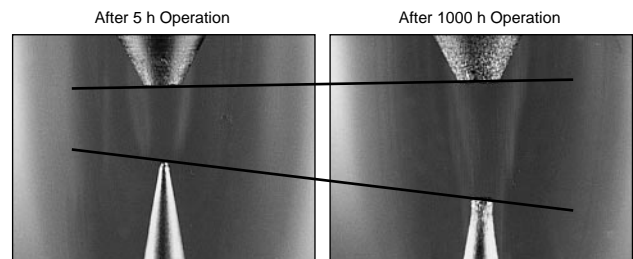

## POWER SUPPLY

Mercury-Xenon Lamps must have a stable light emission output to be used as light source for measuring purposes. Therefore, because the output radiant intensity is approximately in proportion to the current flowing into the lamp, a stabilized power supply should be provided for the lamp. Figure 4 shows a diagram of such a stabilized power supply consisting of a main power supply and a trigger power supply. Stabilized power supplies specifically designed for Hamamatsu SQ Mercury-Xenon Lamps are also available from Hamamatsu (See page 8).

Figure 4: Block Diagram of Stabilized Power Supply

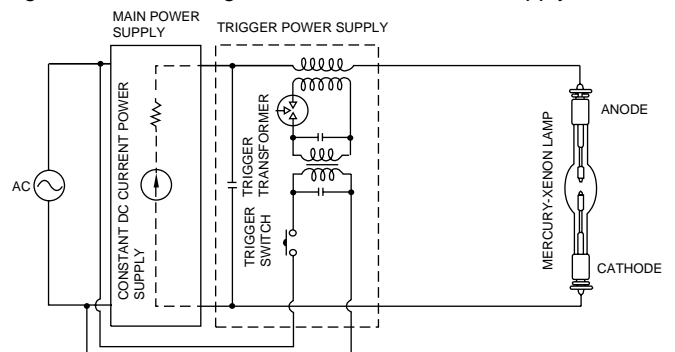

TLSXC0034EA

## 1) Main Power Supply

Besides supplying the lamp with stable dc power, the main power supply keeps the cathode at the optimal operating temperature with a specified current. The cathode temperature is very important for lamps: when too high, evaporation of the cathode materials is accelerated; when too low, work function becomes worse, causing cathode sputtering which greatly reduces the lamp's life.

The lamp current must be set within a specified range to ensure lamps to operate stably for a long time. For this reason, each wattage lamp has their respective operating lamp current values and ranges. Since the radiant intensity is approximately in proportion to the lamp current values (as agreed from Figure 9), the power supply must be designed with higher stability than is required from the lamp.

## 2) Trigger Power Supply

This is for starting the lamp to discharge. As shown in Figure 4, it gives a high frequency triggering pulse to the lamp load by inductive coupling. The lamp's initial discharge characteristic is that its starting voltage is approximately 10 kV. However, the characteristic fluctuates according to cathode fatigue or variations of the filled-in gas pressures. Therefore, in actual devices a triggering voltage of approximately 20 to 25 kV should be applied, taking safety margin into consideration as well.

## CHARACTERISTICS

With regard to data which differs with the wattage ratings, a typical example would be the use of a 200 W lamp (type L2423). The unspecified data that is given, applies to all the lamps irrespective of the wattage of lamp.

### 1) Spectral Distribution

The radiation spectrum of the lamp has strong brilliant line spectra from the ultraviolet to the visible range. Figure 5 shows the radiated spectral distribution, for Mercury-Xenon lamps and other lamps. This spectral distribution includes both the radiation spectrum of a Xenon lamp and brilliant mercury line spectra.

Figure 6 shows a comparison of the radiated spectral distribution of a Mercury-Xenon Lamp and a super-high-pressure mercury lamp. Compared to the super-high-pressure mercury lamp, the Mercury-Xenon Lamp provides greater radiation intensity in the deep UV range from 300 nm downward, and is characterized by sharp line spectra with high peak.

Figure 5: Spectral Distribution of Various Lamps

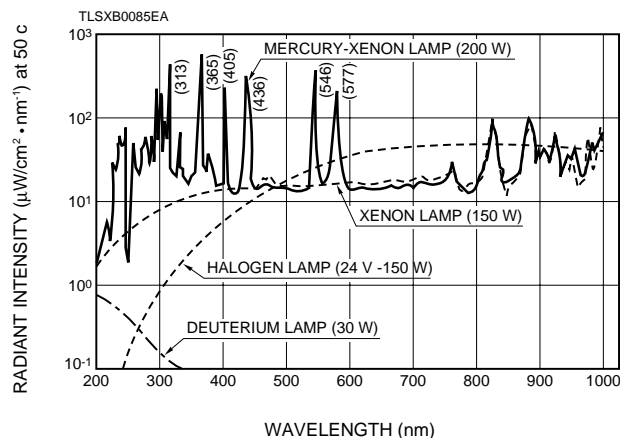
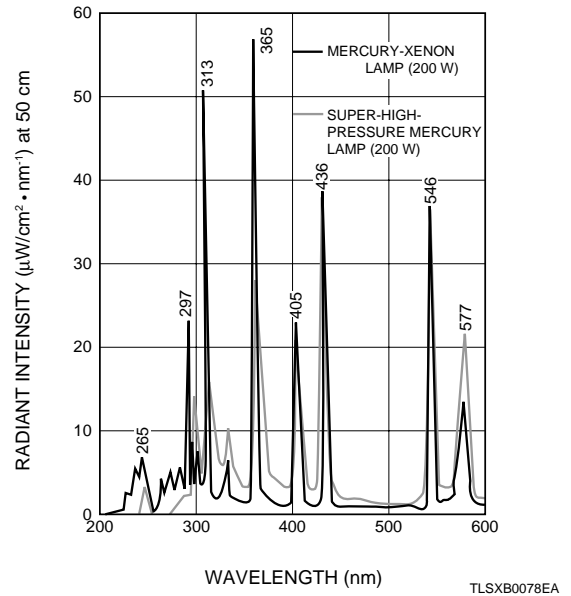

Figure 6: Comparison of Mercury-Xenon Lamp with Super-High-Pressure Mercury Lamp



### 2) Luminance Distribution

Maximum luminance is located nearby the cathode, and it decreases towards the anode. Figure 7 shows the luminance for a 200 W lamp distribution relative to the cathode area.

Figure 7: Luminance Distribution (200 W Lamp L2423)

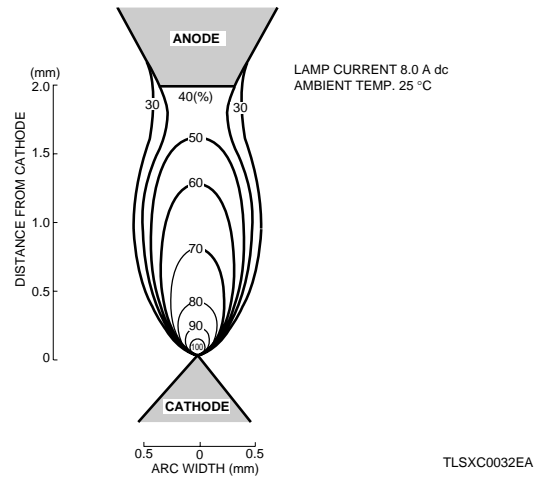

### 3) Flux Distribution

Figure 8 shows the flux distribution of the lamps. It has uniform distribution in the horizontal direction.

Figure 8: Flux Distribution (at Vertical Operation)

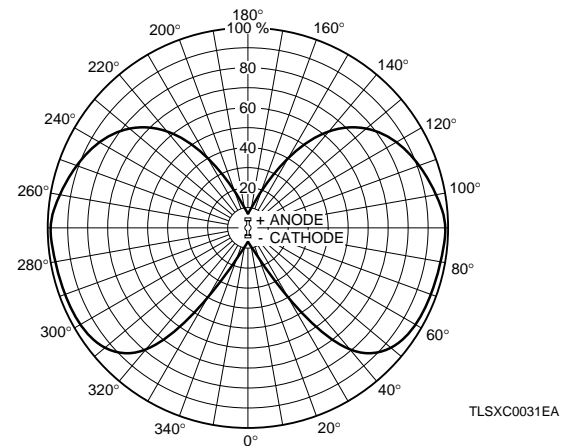

# SUPER-QUIET MERCURY-XENON LAMPS

## 4) Lamp Current and Lamp Voltage

Figure 9 shows the current-voltage characteristic. The lamp voltage slightly increases in accordance with the lamp current.

Figure 9: Current-Voltage Characteristic (200 W Lamp L2423)

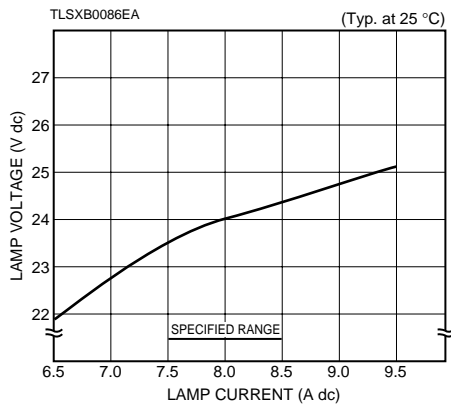

## 5) Stability of Radiant Intensity

### 5)-1 Radiant Intensity and Lamp Current

The output radiant intensity changes in proportion to the lamp current. Figure 10 shows their relation. Furthermore, compared to a super-high-pressure mercury lamp, the lamp reaches its maximum radiant intensity within a very short time. This is because the discharge through the enclosed xenon gas causes the mercury to be efficiently vaporized. This is shown in Figure 11.

Figure 10: Radiant Intensity vs. Lamp Current (200 W Lamp L2423)

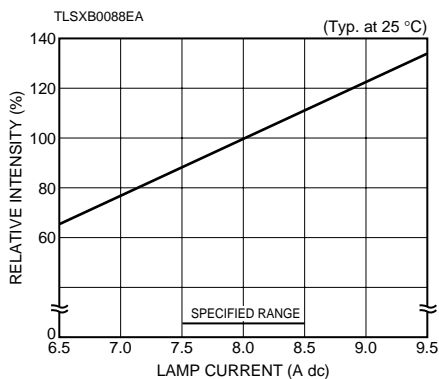
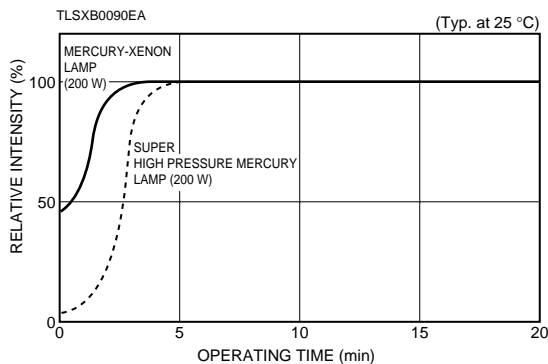

Figure 11: Radiant Intensity vs. Initial Operating Time (200 W Lamp L2423)



## LIFE

### 1) Radiant Intensity and Operating Time

The light output intensity decreases with operating time. This is due to a loss of glass transmittance caused by blackening the bulb wall. This is due to evaporation of the cathode material, and partly by solarization effects from ultraviolet radiation on the bulb glass crystals. Figure 12 shows the change of radiant intensity as a function of the operating time.

Figure 12: Radiant Intensity vs. Operating Time (200 W Lamp L2423)

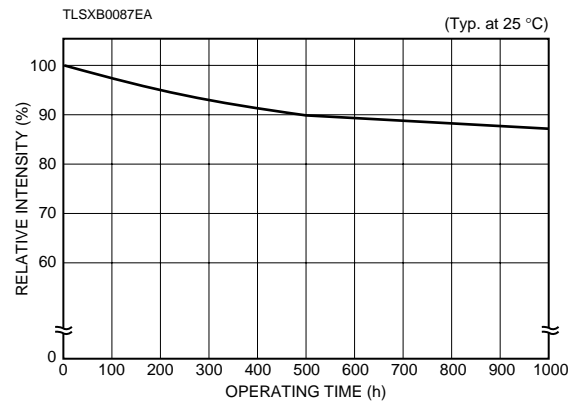

### 2) Lamp Voltage and Operating Time

The electrode distance in conventional lamps is gradually increased due to sputtering phenomenon, resulting in increased lamp voltage. Contrary to it, the SQ Mercury-Xenon Lamp exhibits negligible electrode sputtering and therefore, the lamp voltage is almost constant over a long period of operation. Figure 13 shows the change of the lamp voltage vs. operating time.

Figure 13: Lamp Voltage vs. Operating Time (200 W Lamp L2423)

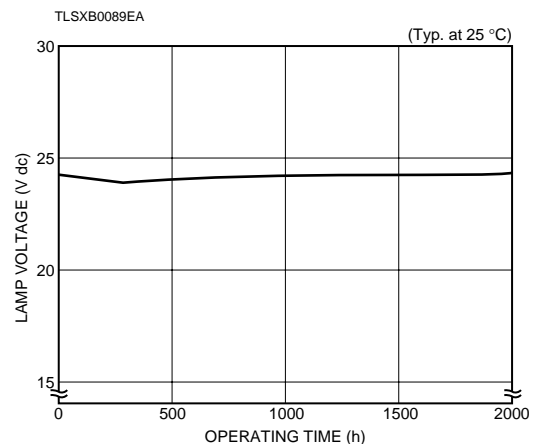

### 3) Fluctuation and Operating Time

As has been stated, the radiant intensity decreases with operating time. No conspicuous change in fluctuation, however, occurs with the elapsing of operating time. Figure 15 a) - d) show the change in fluctuation according to the elapsed operating time and Figure 14 shows the block diagram for fluctuation measurement.

Figure 14: Block Diagram for Fluctuation Measurement

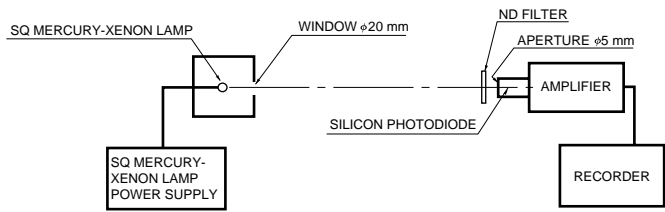

TLSXC0030EA

Figure 15: Fluctuation vs. Operating Time

a) After 5 h operation

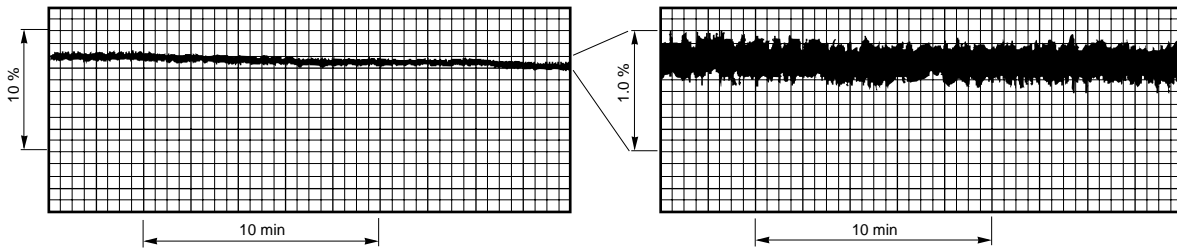

b) After 500 h operation

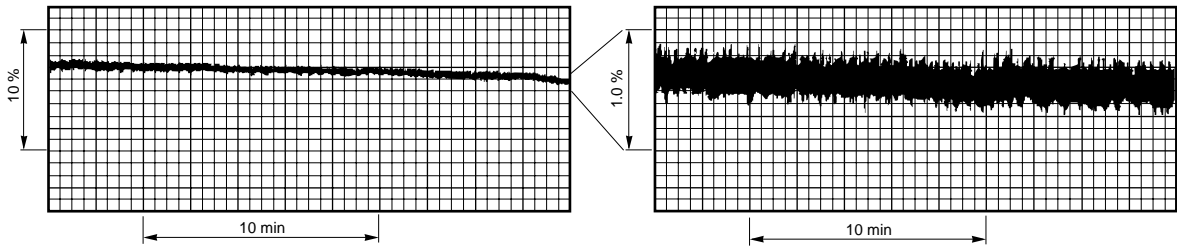

c) After 1000 h operation

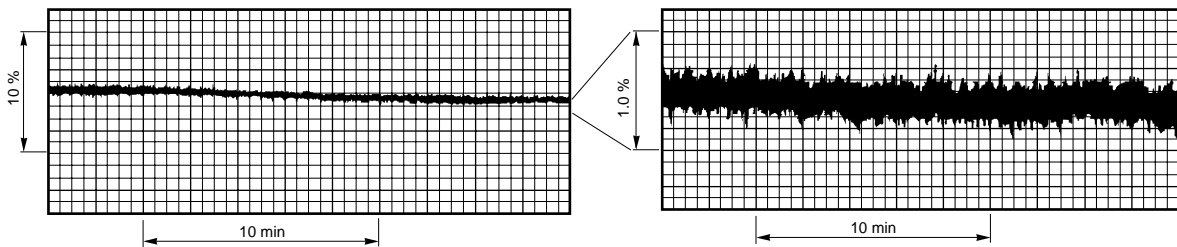

d) After 1500 h operation

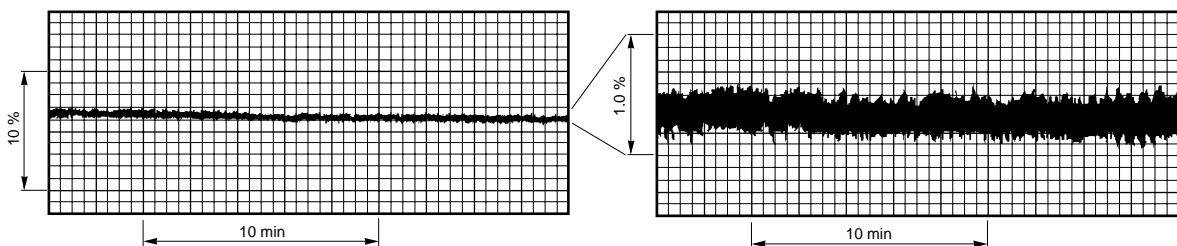

TLSXB0091EA

# SUPER-QUIET MERCURY-XENON LAMPS

Type No.	Remarks	Power Consumption (W)	Arc Length (mm)	Outline	Window Material	Lamp Current (A dc)	Lamp Voltage (V dc)	Supply Voltage <sup>Ⓐ</sup> Typ. (V dc)	Trigger Voltage (kV)
L2421	50 W, Cathode Metal Base $\phi$ 7.5 mm	50	1.0	①	Fused Silica	3.5 $\pm$ 0.5	14	50	15
L2481	75 W, Cathode Metal Base $\phi$ 9 mm	75	1.0	②	Fused Silica	5.4 $\pm$ 0.5	14	50	15
L2481-01	75 W, Cathode Metal Base $\phi$ 7.5 mm			③					
L2481-02	75 W, Metal Base with Screw			④					
L2422	100 W, Cathode Metal Base $\phi$ 9 mm	100	1.3	⑤	Fused Silica	5.5 $\pm$ 0.5	18	50	15
L2422-01	100 W, Cathode Metal Base $\phi$ 7.5 mm			⑥					
L2422-02	100 W, Metal Base with Screw			⑦					
L7046	100 W, Ozone-free Silica Bulb, Metal Base $\phi$ 9 mm			⑧					
L2482	150 W, Metal Base with Screw	150	1.7	⑧	Fused Silica	7.5 $\pm$ 0.5	20	65	20
L7047	150 W, Ozone-free Silica Bulb, Metal Base with Screw			Ozone-free Silica					
L2423	200 W, Metal Base with Screw	200	2.0	⑨	Fused Silica	8.0 $\pm$ 0.5	24	65	20
L2423-01	200 W, Metal Base $\phi$ 12.7 mm			⑩					
L2570	200 W, Ozone-free Silica Bulb, Metal Base with Screw			⑨	Ozone-free Silica				
L2570-01	200 W, Ozone-free Silica Bulb, Metal Base $\phi$ 12.7 mm			⑪					
L2483	350 W, Metal Base with Screw	350	2.5	⑪	Fused Silica	14.0 $\pm$ 1.0	25	70	30
L2917	350 W, Ozone-free Silica Bulb, Metal Base with Screw			Ozone-free Silica					
L2424	500 W, Metal Base with Screw	500	3.0	⑫	Fused Silica	20.0 $\pm$ 1.0	25	70	30

NOTE: Ⓐ Open-circuit voltages necessary for certain lighting of lamps.

Ⓑ The life end is defined as the time when the radiant intensity falls to 50 % of its initial value or when the output fluctuation exceeds  $\pm 1$  %.

① L2421

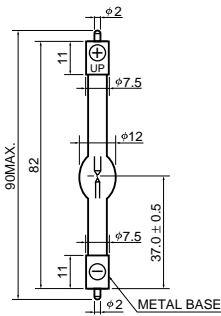

TLSXA0045EB

② L2481

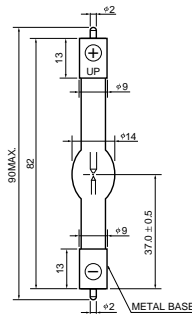

TLSXA0005EB

③ L2481-01

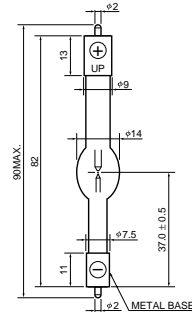

TLSXA0006EB

④ L2481-02

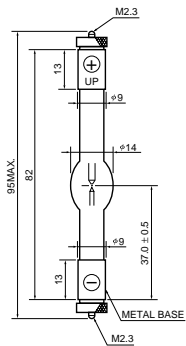

TLSXA0007EB

⑤ L2422, L7046

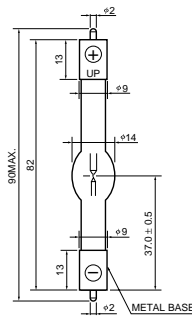

TLSXA0005EB

⑥ L2422-01

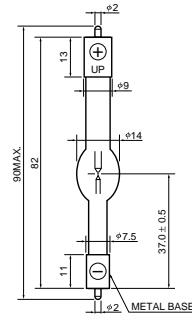

TLSXA0006EB

Output Stability		Life		Orientation (degree)	Cooling	Weight (g)	HAMAMATSU® Power Supply Type No.	Type No.
Drift Typ. (%)	Fluctuation (p-p) Max. (%)	Guar- anteed Life (h)	Aver- age Life (h)					
±0.5	2.0	500	1000	Vertical ±15 or Horizontal ±15	Not required	10	C6979, C2577	L2421
±0.5	2.0	500	1000	Vertical ±15 or Horizontal ±15	Not required	14	C6979 C2577	L2481
						18		L2481-01 L2481-02
±0.5	2.0	500	1000	Vertical ±15 or Horizontal ±15	Not required	15	C6979 C2577	L2422
						18		L2422-01 L2422-02
						15		L7046
±0.5	2.0	1000	2000	Vertical ±15 or Horizontal ±15	Not required	43	C7535 C2577	L2482 L7047
±0.5	2.0	1000	2000	Vertical ±15 or Horizontal ±15	Not required	45	C7535 C2577	L2423
						55		L2423-01
						45		L2570
						55		L2570-01
±0.5	2.0	500	1000	Vertical ±15	Forced Air Cooling	70	C4338 C2578	L2483 L2917
±0.5	2.0	500	1000	Vertical ±15	Forced Air Cooling	80	C2578	L2424

© These dropper type power supplies need trigger unit. Please refer the page 8.

Unit: mm

**7 L2422-02**

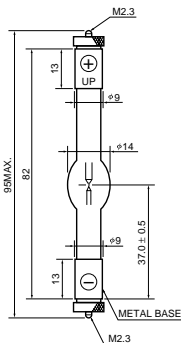

TLSXA0007EB

**8 L2482, L7047**

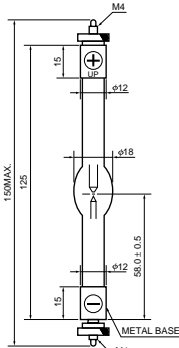

TLSXA0055EC

**9 L2423, L2570**

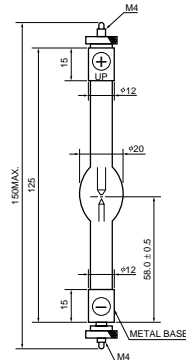

TLSXA0008EB

**10 L2423-01, L2570-01**

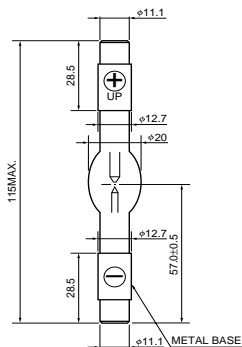

TLSXA0046EB

**11 L2483, L2917**

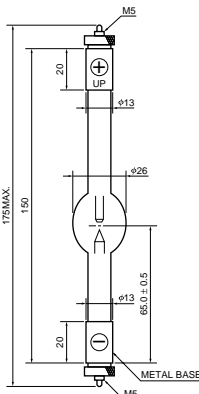

TLSXA0009EB

**12 L2424**

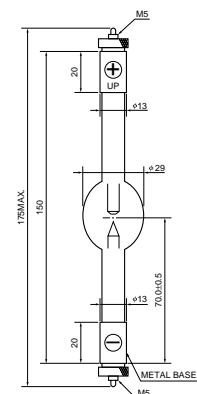

TLSXA0047EB



# ACCESSORIES

## LAMP POWER SUPPLIES

Using Mercury-Xenon lamps in photometric applications requires an extremely stable power supply. We recommend using Hamamatsu power supplies to obtain full performance from super-quiet Mercury-Xenon lamps. Hamamatsu provides two types of power supplies: dropper type and switching type. Dropper type power supplies feature extremely high stability. Switching type power supplies have less stability but offer advantages such as light weight and high cost performance. Select the type that meets your application.

Hamamatsu also manufactures various types of OEM power supplies. Please feel free to consult us with your specific needs.



▲ C6979

Type No.	Control Method	Suitable Lamps (W)	Input (V ac)	Discharge Current Stability (at +25 °C)		Dimensions <sup>Ⓐ</sup> (mm)	Weight (kg)	Trigger Unit <sup>Ⓑ</sup>	Start Method	NOTE
				Ripple (p-p) Max. (%)	Drift Max. (%/h)					
C6979	Dropper Type	50/75/100	100/118	0.1	±0.1	144 × 176 × 280	10	C4251	Manual <sup>Ⓒ</sup>	High stability, with time counter
C7535		150/200	200/230							
C4338		350	100/118							
C2577	Switching Type	50/75/100/150/200	100/118	5	±4	150 × 180 × 280	4	—	Manual	Light weight, for general purpose
C2578		350/500	200/230							

NOTE: ⒶExcluding projection parts.

ⒷThe dropper type power supplies are used in conjunction with the C4251 or C4339 Trigger Unit (option).

ⒸAuto-start type power supplies are also available upon request.

These power supplies use a trigger mode in which a positive high voltage is applied to the anode; so use care concerning the insulation for the anode.

### ● Block Diagram for Dropper Type

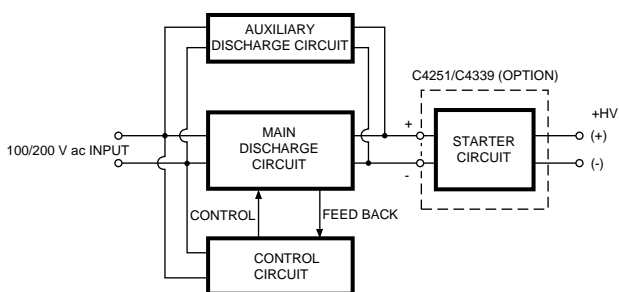

TLSXC0009EB

### ● Block Diagram for Switching Type

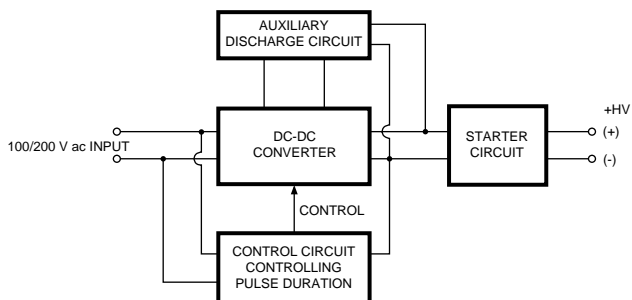

TLSXC0010EB



## ELLIPSE REFLECTORS

Hamamatsu also provides the Ellipse Reflectors developed for SQ Xenon/SQ Mercury-Xenon lamp (cartridge type). Stable light output will be obtained without any adjustment of the optical axis till the end of lamp life. The arc point of Hamamatsu SQ Xenon/SQ Mercury-Xenon lamps has excellent stability. Therefore, cartridge type SQ lamps (trouble-free optical axis for lamp exchange) can be employed. It will be able to be applicable for wide variations like UV curing and etc. Hamamatsu can offer wide variation in its options for your applications.

When a lamp is used with an elliptic reflector, a different type of power supply may be required. Please consult our sales office for a suitable power supply.



▲ E4169 / E4168

## LAMP HOUSINGS

For simple and safe use of lamps, Hamamatsu provides lamp housings that give optimal performance in terms of light output stability, efficiency and life.

There are three types of lamp housings: the E7536 (for 150 W and 200 W lamps) is designed to improve handling, while the E2419 (for 75 W and 100 W lamps) and E2420 (for 150 W and 200 W lamps) feature simplified configurations.

The E7536 ensures excellent lamp stability and high output of collimated light by means of the built-in reflecting mirror and exit lens. A built-in interlock function, lamp starter and air cooling fan enhance operator safety. The temperature within the lamp housing is held below 40 °C. Moreover, 3-axis adjusting screws are provided on the outside of the housing to allow simple optical-axis alignment, making it really easy to use. Simplified type E2419 and E2420 lamp housings are compact and ideal for experimental setups. These lamp housings can be readily mounted on a commercially available optical stand.



▲ E7536

Unit: mm

**E7536 (For 150 W, 200 W Lamps)**

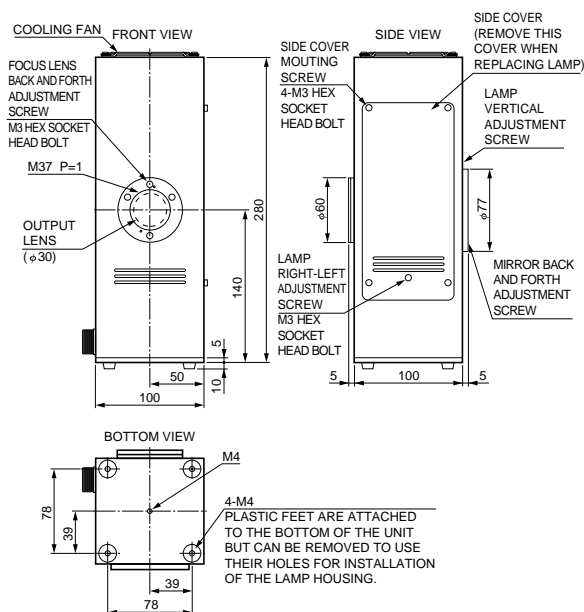

TLXA0083EA

**E2419 (For 75 W, 100 W Lamps), E2420 (For 150 W, 200 W Lamps)**

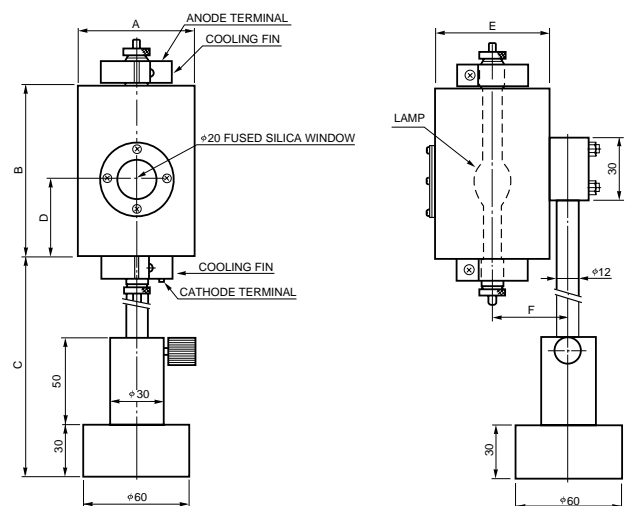

	A	B	C	D	E	F	Weight
E2419	50	56	110 to 140	24	50	35	1.1 kg
E2420	65	95	90 to 120	43	65	42.5	1.2 kg

TLXA0011EA

# HANDLING PRECAUTIONS

## HANDLING PRECAUTIONS (Read before using)

### Installation Precautions

#### 1. Always handle the lamp with protective cover in place.

High pressure gas (approx. 1 MPa at room temperature, approx. 4 MPa during operation) is contained in the lamps. Inflicting strong shocks to the lamp or scratching of the surface of the glass bulb may cause the bulb to burst, causing danger from flying glass fragments.

When handling lamps, always wear a long sleeved shirt and gloves for protection as well as a face protector.

This protective cover is also necessary when replacing lamps; so store it for future use. (Refer to item 8.)

#### 2. Never touch the glass portion of a lamp with bare hands.

Lighting a lamp with dust or fingerprints on it causes print marks and loss of bulb transmittance, thus lowering the light output and the mechanical strength of the glass bulb. To remove dust and fingerprints, wipe the bulb off using cotton or gauze moistened with high-quality alcohol or acetone, and thoroughly wrung out. Use care not to apply and strong shocks.

#### 3. Install the lamp correctly.

(A) Correct polarity of the lamp is important. Even momentary reversal of the polarity will damage the cathode, causing failure of the lamp and will void the warranty. When installing the lamp vertical to the ground, insure that the indication marking which denotes "UP" is in the proper position. This indication marking can be found on the anode side of the metal base, and also on the plastic lamp protector.

(B) When installing the lamp in the horizontal position make sure the "tip-off" is parallel to the ground. Adjust the arc point of the lamp so that the discharge stays along the center line of both electrodes. This can be accomplished by the use of a magnetic field.

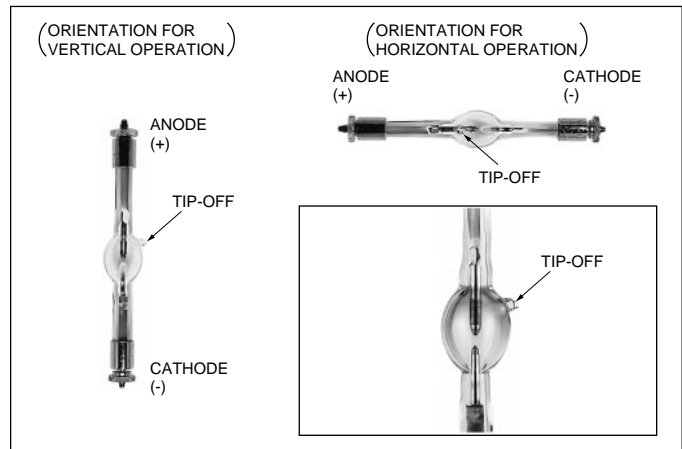

It is necessary to use an adequate magnet and set it at correct position in order to get the best performance of lamps, according to the following table.

Type	Surface Magnetic Flux Density (10 <sup>-3</sup> Tesla)	Distance (mm)	Position (Direction)	Magnet Example
75 W 100 W	9.5 to 10.5	38±1.0	See Fig. 1	TDK Co. FB3G D10-5 (10 mm dia. 5 mm thickness)
150 W 200 W	12 to 12.5	55±1.0	See Fig. 2	TDK Co. FB3G D15-7 (15 mm dia. 7 mm thickness)

NOTE : "DISTANCE" in the table defines the distance between the center of arc and the surface of a magnet.

Fig.1

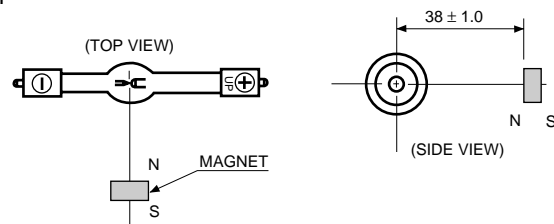

Unit: mm

TLSXC0011EA

Fig.2

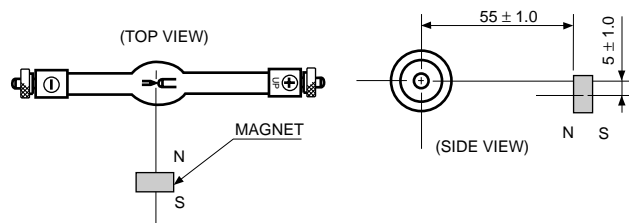

Unit: mm

TLSXC0012EA

## Operational Precautions

### 4. Use caution concerning the high temperature and high voltage.

These lamps start discharge at high triggering voltage of 20 kV. Be sure insulation is sufficient to prevent danger of electrical shock. During operation and immediately after, the lamp is extremely hot, so never touch with the hands or place them close to highly combustible material.

### 5. Caution concerning ultraviolet radiation.

These lamps radiate ultraviolet rays which are harmful to the eyes and skin. Avoid looking directly at a lamp or allowing its light to fall directly on the skin, as there is danger of burning injury.

### 6. Always observe the rated values.

The rated operating current for these lamps is specified (refer to pages 6, 7.). If used outside the specified range, operation will become unstable and the life will be shortened drastically. Operation outside the rated values will void the Hamamatsu warranty. The 350 W type and 500 W type requires forced air cooling.

### 7. Replace the lamp after the total number hours of operation exceeds the average life plus 500 h, or when the inner walls of the bulb become extremely blackened.

When the total number of hours operation has exceeded the average life plus 500 h, vaporization of the electrodes and sputtering on the bulb causes progressive darkening, lowering the lamp's heat radiation and increasing the interior temperature and pressure of the lamp to dangerous levels that could lead to breakage. Thus, when either condition is observed, replace the lamp immediately.

## Removal Precautions

### 8. Handle used lamps with the protective cover.

When removing a lamp from the lamp housing, wait until cools. Since high-pressure gas is contained in the lamp, rough handling can cause the lamp to shatter; therefore handle used lamps as carefully as new lamps. Then enclose it to the protective cover as it was.

The Mercury-Xenon Lamp should be discarded through an approved waste disposal company, or should be returned to any Hamamatsu sales representative with repacked in its original packing (or in an equivalent secure package).

## CONCERNING LAMP HOUSINGS

### Consider The Following Points When Designing A Lamp Housing

#### A. A lamp housing should always have a sturdy cover.

High pressure gas (approx. 1 MPa at room temperature, approx. 4 MPa during operation) is contained in the lamps. Lamp housings should always have a sturdy cover in anticipation of the possibility of the lamp shattering for any reason.

#### B. Do not fasten lamps at both ends when installing.

The glass bulbs of lamps expand from heat during operation. Use a flexible fitting at one end (normally the anode side) and construction that can absorb the heat expansion.

#### C. When focusing the light, take care to avoid excessively high internal lamp operating temperatures.

When focusing the light from a lamp with a mirror, etc., the lamp operating temperature can become extremely high if there is a focal point on the bulb wall or electrode. Use care concerning operating temperature when using such a mirrors, etc.

#### D. Use caution concerning high operating temperatures.

Maintain the lamp surface temperature at less than 750 °C (1382 °F) and the metal base surface temperature (anode side) at less than 200 °C (392 °F). (The temperature at the anode is normally higher than at the cathode.)

If the lamp operating temperature exceeds these upper limits, oxidation of the electrode wire as well as excessive consumption of electrodes and filled gas occur and greatly shorten the lamp life. The pressure inside the lamp may also increase excessively and cause the lamp to shatter. Leave allowance for the heat capacity of the lamp housing for efficient heat radiation.

Forced air cooling with a fan is necessary for the 350 W and 500 W lamps, so take care to ensure that the fan does not stop during operation and for 3 to 5 minutes after turning the lamp off. Convection currents in the xenon gas filled in the lamps increase considerably when a strong breeze from a fan blows directly on a lamp, lowering the light output stability, so position the fan carefully.

## E. Install sufficient high voltage insulation to avoid leakage of trigger high voltage.

Use high quality insulation materials and maintain adequate insulating distances since the trigger voltage reaches 20 kV to 30 kV upon start-up. A 1 cm (3/8") air gap will withstand only about 10 kV before arc discharge occurs. The power supply output should be delivered with a high-voltage (more than a few tens kV) and heat resistant, non-flammable cable, which should be as short as possible. Make sure there is no contact between the power supply cable and the metal chassis of the lamp housing. Whenever the possibility of contact exists, a high quality silicon insulating material should be employed.

## F. Ensure the lamp holder is not oxidized.

Ensure the lamp holder is not oxidized. If it is oxidized, there will be heating in the lamp holder and the radiant intensity may become unstable due to the lack of contact. When it is oxidized, the lamp holder should be replaced or the oxide should be removed.

### WARNING



- Do not look at the lamp without proper eye protection while in operation.
  - UV (ultraviolet) rays can damage the eyes and permanently may impair eyesight.

- The lamp radiates UV rays which are harmful to your skin.
  - UV ray may injure skin exposed to it.



- Do not place flammable material near the lamp when in operation.
  - Placing the operating lamp near flammable materials may cause a fire.

- The lamp reaches high temperature while in operation, and shortly after turn-off, use care when touching the lamp.
  - High temperature lamps will cause burns.



- The lamp has high internal gas pressure, do not subject it to shock, stress or scratches. These stresses may result in the explosion of the envelope.

- The lamp must be installed in proper housing before operation.
  - If broken, flying glass fragments may cause injury.



- The power supply to the lamp must be turned off before installation or removal, or any maintenance.
  - Failure to do this may result in electrical shocks, damage to eyesight or skin burns, etc.

### CAUTION



- Observe the installation direction and polarity of lamps.
  - Incorrect installation may damage the lamp.

- Be sure to use a power supply that provides an optimal current value for the lamp.
  - Use of an improper power supply may cause overheating or damage the lamp.



- Do not use the lamp in damp locations subject to high humidity, precipitation, or condensation.
  - Operating the lamp in high humidity may result in electrical shocks or damage to the lamp.



- Always wear a protective mask and garment when installing or removing the lamp.
  - If broken, exploding glass fragments may cause injury.

## WARRANTY

The warranty period will be one year after shipment or specified life time comes first. The area of warranty is limited to replacement of the faulty lamp. Faults resulting from natural disasters and incorrect usage will also be excluded from warranty.

## RELATED LAMPS

### Metal Halide Lamps

Since Metal Halide Lamps have a flash efficiency approx. 4 times higher than halogen lamps and xenon lamps, they can produce an output 4 times higher if power consumption is same. In addition, the short-arc type is similar to a point light source, making optical design easy. The short life problem caused by the short arc has also been solved, thereby achieving a long life of more than 3000 h in the case of the 575 W type. As their color temperature characteristics are similar to daylight color, exact colors (RGB) can be reproduced.

Metal Halide Lamps are suitable in applications such as overhead projectors and liquid crystal projectors.

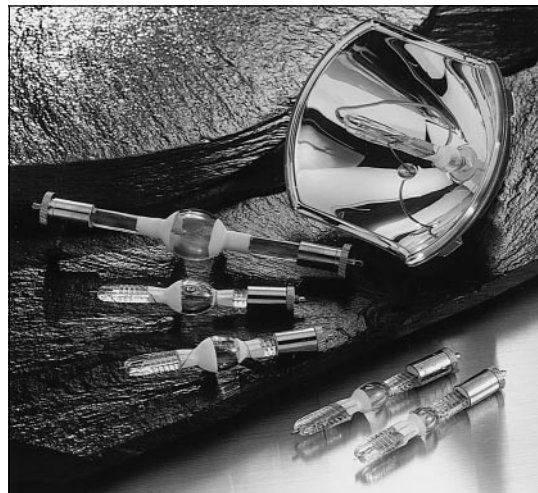

### Super-Quiet Xenon Lamps

Hamamatsu is producing Super-Quiet Xenon Lamps as continuous spectrum light sources. The radiation spectral distribution is continuous over the ultraviolet, visible and infrared ranges, so these lamps are ideal as light sources for all kinds of photometric purposes such as spectrophotometers and so on. Depending on the application, various types of lamps are available from 35 W to 300 W.



### Super-Quiet Xenon Flash Lamps

The Super-Quiet Xenon Lamp lineup also includes flash mode models having compact, small heat generation and good arc stability. It has the good features for high precision photometry in better stability of 5 times and longer lifetime of 10 times than conventional lamps.

Depending on the applications. Hamamatsu can offer SQ type having excellent stability, built-in reflector type with high output power and HQ type for general use.

They are also applicable for the light source in high speed camera operation and strobe light source.

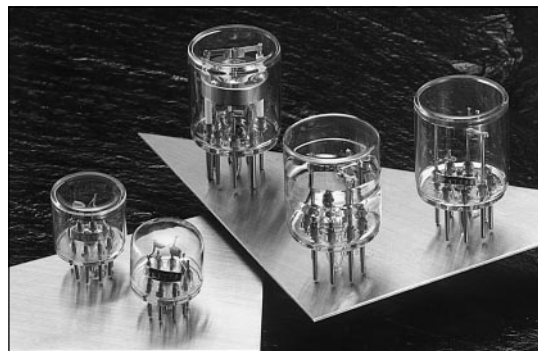

For details, refer to the catalogs which are available from our sales offices.

\*PATENT : JAPAN Pat. No. 1508827

# HAMAMATSU

HOME PAGE URL <http://www.hamamatsu.com>

HAMAMATSU PHOTONICS K.K., Electron Tube Center

314-5, Shimokanzo, Toyooka-village, Iwata-gun, Shizuoka-ken, 438-0193, Japan, Telephone: (81)539/62-5248, Fax: (81)539/62-2205

U.S.A.: Hamamatsu Corporation: 360 Foothill Road, P. O. Box 6910, Bridgewater, N.J. 08807-0910, U.S.A., Telephone: (1)908-231-0960, Fax: (1)908-231-1218

Germany: Hamamatsu Photonics Deutschland GmbH: Arzbergerstr. 10, D-82211 Herrsching am Ammersee, Germany, Telephone: (49)8152-375-0, Fax: (49)8152-2658

France: Hamamatsu Photonics France S.A.R.L.: 8, Rue du Saule Trapu, Parc du Moulin de Massy, 91882 Massy Cedex, France, Telephone: (33)1 69 53 71 00, Fax: (33)1 69 53 71 10

United Kingdom: Hamamatsu Photonics UK Limited: Lough Point, 2 Gladbeck Way, Windmill Hill, Enfield, Middlesex EN2 7JA, United Kingdom, Telephone: 44(20)8-367-3560, Fax: 44(20)8-367-6384

North Europe: Hamamatsu Photonics Norden AB: Smidesvägen 12, SE-171-41 SOLNA, Sweden, Telephone: (46)8-509-031-00, Fax: (46)8-509-031-01

Italy: Hamamatsu Photonics Italia: S.R.L.: Strada della Moia, 1/E, 20020 Arese, (Milano), Italy, Telephone: (39)02-935 81 733, Fax: (39)02-935 81 741

TLSX1009E07  
MAR. 2000 IP  
Printed in Japan (1000)