

General Purpose Transistors

PNP Silicon

- We declare that the material of product compliance with RoHS requirements.
- S- Prefix for Automotive and Other Applications Requiring Unique Site and Control Change Requirements; AEC-Q101 Qualified and PPAP Capable.

● DEVICE MARKING AND ORDERING INFORMATION

Device	Marking	Shipping
L2SA1774QT1G S-L2SA1774QT1G	FQ	3000/Tape&Reel
L2SA1774QT3G S-L2SA1774QT3G	FQ	10000/Tape&Reel
L2SA1774RT1G S-L2SA1774RT1G	FR	3000/Tape&Reel
L2SA1774RT3G S-L2SA1774RT3G	FR	10000/Tape&Reel
L2SA1774ST1G S-L2SA1774ST1G	FS	3000/Tape&Reel
L2SA1774ST3G S-L2SA1774ST3G	FS	10000/Tape&Reel

L2SA1774QT1G
Series
S-L2SA1774QT1G
Series

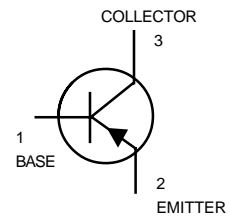
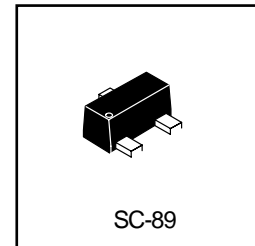

● Absolute maximum ratings (Ta=25°C)

Parameter	Symbol	Limits	Unit
Collector-base voltage	V _{CB0}	-60	V
Collector-emitter voltage	V _{CEO}	-50	V
Emitter-base voltage	V _{EB0}	-6	V
Collector current	I _c	-0.15	A (DC)
Collector power dissipation	P _c	0.15	W
Junction temperature	T _j	150	°C
Storage temperature	T _{stg}	-55~+150	°C

● Electrical characteristics (Ta=25°C)

Parameter	Symbol	Min.	Typ.	Max.	Unit	Conditions
Collector-base breakdown voltage	BV _{CB0}	-60	-	-	V	I _c =-50μA
Collector-emitter breakdown voltage	BV _{CEO}	-50	-	-	V	I _c =-1μA
Emitter-base breakdown voltage	BV _{EB0}	-6	-	-	V	I _E =-50μA
Collector cutoff current	I _{CB0}	-	-	-0.1	μA	V _{CB} =-60V
Emitter cutoff current	I _{EB0}	-	-	-0.1	μA	V _{EB} =-6V
Collector-emitter saturation voltage	V _{CE(sat)}	-	-	-0.5	V	I _c /I _E =-50mA/-5mA
DC current transfer ratio	h _{FE}	120	-	560	-	V _{CE} =-6V, I _c =-1mA
Transition frequency	f _T	-	140	-	MHz	V _{CE} =-12V, I _E =2mA, f=30MHz
Output capacitance	C _{ob}	-	4.0	5.0	pF	V _{CB} =-12V, I _E =0A, f=1MHz

- h_{FE} values are classified as follows:

Item	Q	R	S
h _{FE}	120~270	180~390	270~560

L2SA1774QT1G
Series
S-L2SA1774QT1G
Series

●Electrical characteristic curves

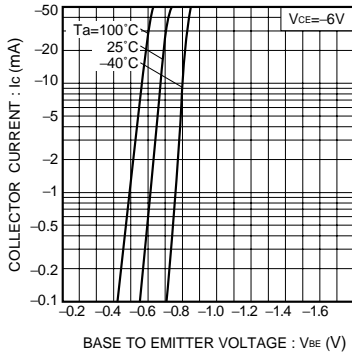

Fig.1 Grounded emitter propagation characteristics

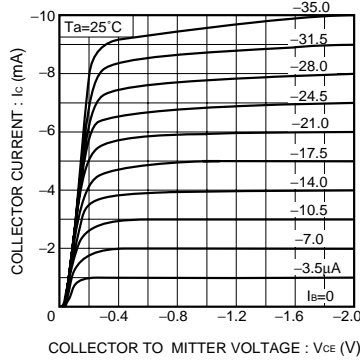

Fig.2 Grounded emitter output characteristics (I)

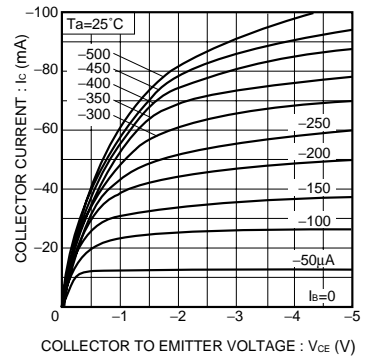

Fig.3 Grounded emitter output characteristics (II)

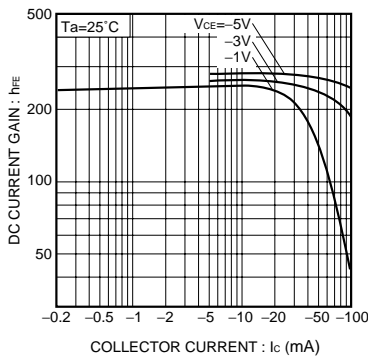

Fig.4 DC current gain vs. collector current (I)

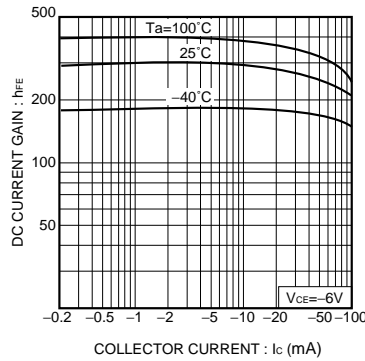

Fig.5 DC current gain vs. collector current (II)

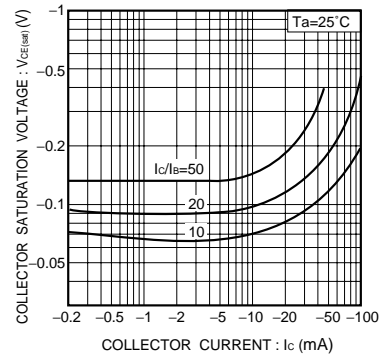

Fig.6 Collector-emitter saturation voltage vs. collector current (I)

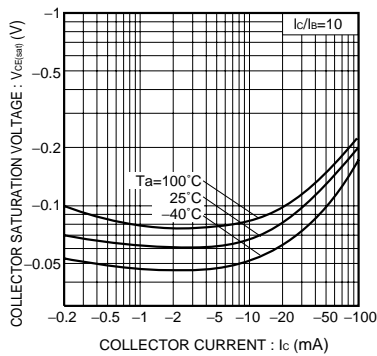

Fig.7 Collector-emitter saturation voltage vs. collector current (II)

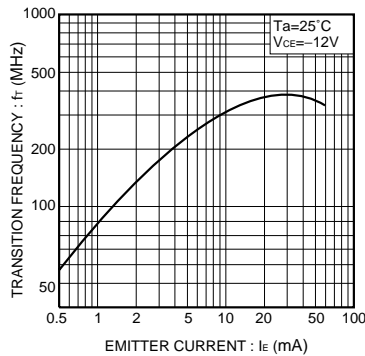

Fig.8 Gain bandwidth product vs. emitter current

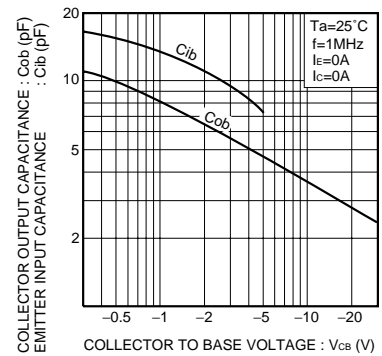
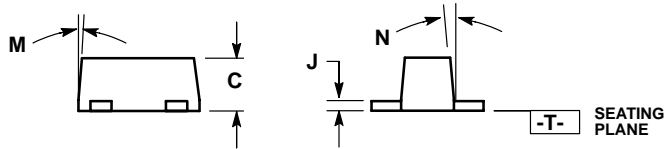
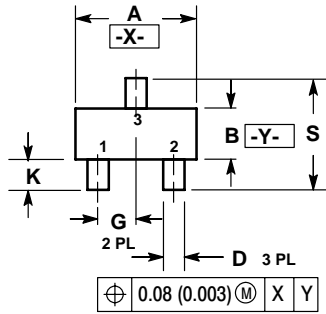

Fig.9 Collector output capacitance vs. collector-base voltage
Emitter input capacitance vs. emitter-base voltage

L2SA1774QT1G

Series
S-L2SA1774QT1G
Series

SC-89



NOTES:

1. DIMENSIONING AND TOLERANCING PER ANSI Y14.5M, 1982.
2. CONTROLLING DIMENSION: MILLIMETERS
3. MAXIMUM LEAD THICKNESS INCLUDES LEAD FINISH THICKNESS. MINIMUM LEAD THICKNESS IS THE MINIMUM THICKNESS OF BASE MATERIAL.
4. 463C-01 OBSOLETE, NEW STANDARD 463C-02.

DIM	MILLIMETERS			INCHES		
	MIN	NOM	MAX	MIN	NOM	MAX
A	1.50	1.60	1.70	0.059	0.063	0.067
B	0.75	0.85	0.95	0.030	0.034	0.040
C	0.60	0.70	0.80	0.024	0.028	0.031
D	0.23	0.28	0.33	0.009	0.011	0.013
G	0.50 BSC			0.020 BSC		
H	0.53 REF			0.021 REF		
J	0.10	0.15	0.20	0.004	0.006	0.008
K	0.30	0.40	0.50	0.012	0.016	0.020
L	1.10 REF			0.043 REF		
M	---	---	10 °	---	---	10 °
N	---	---	10 °	---	---	10 °
S	1.50	1.60	1.70	0.059	0.063	0.067

