



Website:<http://biz.LGservice.com>
E-mail:<http://www.LGservice.com/techsup.html>

COLOR MONITOR

SERVICE MANUAL

CHASSIS NO. : CL-70

MODEL: FLATRON L3200A (L3200AC.ALA)**
FLATRON L3200A (L3200ATC.ALA)**
FLATRON L3200A (L3200AFC.ALA)**
FLATRON L3200A (L3200AKC.ALA)**
() **Same model for Service

CAUTION

BEFORE SERVICING THE UNIT,
READ THE **SAFETY PRECAUTIONS** IN THIS MANUAL.



CONTENTS

SPECIFICATIONS	2	SERVICE OSD	13
PRECAUTIONS	3	TROUBLESHOOTING GUIDE	14
TIMING CHART	7	WIRING DIAGRAM	21
BLOCK DIAGRAM	9	EXPLODED VIEW	22
DESCRIPTION OF BLOCK DIAGRAM.....	10	REPLACEMENT PARTS LIST	24
ADJUSTMENT	11	SCHEMATIC DIAGRAM.....	34

SPECIFICATIONS

1. LCD CHARACTERISTICS

Type : TFT Color LCD Module
 Active Display Area : 31.51inches(800.4mm)diagonal
 Pixel Pitch : 170.25um x 510.75um x RGB
 Color Depth : 8-bit, 16,777,216 colors
 Electrical Interface : LVDS
 Size : 760mm (H) x 450 (D)x48 (D)mm
 Surface Treatment : Anti-Glare, Hard Coating(3H)
 Operating Mode : Normally Black
 Backlight Unit : 20-EEFL

2. OPTICAL CHARACTERISTICS

2-1. Viewing Angle by Contrast Ratio ≥ 10
 Left : -85° min., -88°(Typ) Right : +85° min., +88°(Typ)
 Top : +85° min., +88°(Typ) Bottom : -85° min., -88°(Typ)

2-2. Luminance : 400(min), 500(Typ)

2-3. Contrast Ratio : 400(min), 600(Typ)

3. SIGNAL (Refer to the Timing Chart)

3-1. PC & Video Input
 1)Input Form : AV, SVIDEO, Component1, Component2, RGB PC, DVI PC
 2)Resolution(max) : Analog -1600 x 1200@60Hz
 Digital -1280 x 1024@60Hz

3-2. Sync Input
 Horizontal : 30 ~ 83kHz(Digital: 30~72kHz)
 Vertical : 56 ~ 85Hz
 Input Form : Separate, TTL, Positive/Negative Digital

4. SPECIAL FUNCTION

4-1. Audio
 1)Output Rating : 10W + 10W(Rated Output $\pm 10\%$)
 2)Freq. Character : 100Hz~10KHz Range(-3dB)
 3)T. H. D : Within 10%
 4)Input Sensitivity : 0.700Vrms

4-2. Speaker
 1)TYPE : Detachable
 2)Impedance : 8 Ω
 3)Input : Max : 15W, Normal : 10W

4-2. AV
 1)Video Level : Input : 0.7V
 2)Sync Level : Input : 0.286V
 3)Color Burst : Input : 0.214V
 4)Audio Level : NTSC Input : 0.40V
 PAL Input : 0.5V
 PC Input : 0.7V
 5)Video Cross Talk : 43dB

5. POWER SUPPLY

5-1. Power Adaptor
 Input : AC 100~240V, 50/60Hz , 2.8A

5-2. Power Consumption

MODE	H/V SYNC	VIDEO	POWER CONSUMPTION	LED COLOR
POWER ON (NORMAL)	ON/ON	ACTIVE	less than 160 W	GREEN
STAND-BY	OFF/ON	OFF	less than 4 W	AMBER
SUSPEND	ON/OFF	OFF	less than 4 W	AMBER
DPM OFF	OFF/OFF	OFF	less than 4 W	AMBER
POWER OFF	-	-	less than 2 W	OFF

6. ENVIRONMENT

6-1. Operating Temperature: 10°C~35°C
 6-2. Operating Humidity : 10%~80%
 6-3. MTBF : 50,000 HRS with 90% Confidence level
 Lamp Life : 50,000 Hours(Min.)

7. DIMENSIONS

L3200AC/L3200AKC
 Width : 803 mm (31.61")
 Depth : 99.9 mm (3.93")
 Height : 493 mm (19.41")

L3200ATC(with Stand)
 Width : 803 mm (31.61")
 Depth : 180 mm (7.09")
 Height : 540 mm (21.26")

L3200AFC(with Speaker/Stand)
 Width : 964 mm (37.96")
 Depth : 180 mm (7.09")
 Height : 540 mm (21.26")

8. WEIGHT

L3200AC/L3200AKC
 Net. Weight : 16 kg (35.28 lbs)
 Gross Weight : 20.9 kg (46.08 lbs)

L3200ATC/L3200AFC(with Speaker/Stand)
 Net. Weight : 21.1 kg (46.52 lbs)
 Gross Weight : 26 kg (57.33 lbs)

PRECAUTION

WARNING FOR THE SAFETY-RELATED COMPONENT.

- There are some special components used in LCD monitor that are important for safety. **These parts are marked \triangle on the schematic diagram and the replacement parts list.** It is essential that these critical parts should be replaced with the manufacturer's specified parts to prevent electric shock, fire or other hazard.
- Do not modify original design without obtaining written permission from manufacturer or you will void the original parts and labor guarantee.

TAKE CARE DURING HANDLING THE LCD MODULE WITH BACKLIGHT UNIT.

- Must mount the module using mounting holes arranged in four corners.
- Do not press on the panel, edge of the frame strongly or electric shock as this will result in damage to the screen.
- Do not scratch or press on the panel with any sharp objects, such as pencil or pen as this may result in damage to the panel.
- Protect the module from the ESD as it may damage the electronic circuit (C-MOS).
- Make certain that treatment person's body are grounded through wrist band.
- Do not leave the module in high temperature and in areas of high humidity for a long time.
- The module not be exposed to the direct sunlight.
- Avoid contact with water as it may a short circuit within the module.
- If the surface of panel become dirty, please wipe it off with a softmaterial. (Cleaning with a dirty or rough cloth may damage the panel.)

\triangle CAUTION

Please use only a plastic screwdriver to protect yourself from shock hazard during service operation.

\triangle WARNING

BE CAREFUL ELECTRIC SHOCK !

- If you want to replace with the new backlight (CCFL) or inverter circuit, must disconnect the AC adapter because high voltage appears at inverter circuit about 650Vrms.
- Handle with care wires or connectors of the inverter circuit. If the wires are pressed cause short and may burn or take fire.

Leakage Current Hot Check Circuit

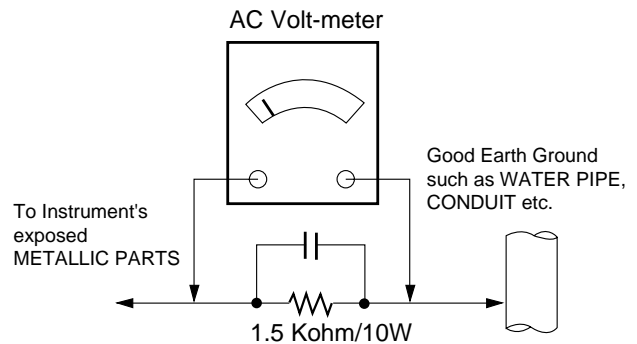

SERVICING PRECAUTIONS

CAUTION: Before servicing receivers covered by this service manual and its supplements and addenda, read and follow the **SAFETY PRECAUTIONS** on page 3 of this publication.

NOTE: If unforeseen circumstances create conflict between the following servicing precautions and any of the safety precautions on page 3 of this publication, always follow the safety precautions. Remember: Safety First.

General Servicing Precautions

1. Always unplug the receiver AC power cord from the AC power source before;
 - a. Removing or reinstalling any component, circuit board module or any other receiver assembly.
 - b. Disconnecting or reconnecting any receiver electrical plug or other electrical connection.
 - c. Connecting a test substitute in parallel with an electrolytic capacitor in the receiver.

CAUTION: A wrong part substitution or incorrect polarity installation of electrolytic capacitors may result in an explosion hazard.

- d. Discharging the picture tube anode.
2. Test high voltage only by measuring it with an appropriate high voltage meter or other voltage measuring device (DVM, FETVOM, etc) equipped with a suitable high voltage probe.
Do not test high voltage by "drawing an arc".
 3. Discharge the picture tube anode only by (a) first connecting one end of an insulated clip lead to the degaussing or kine aquadag grounding system shield at the point where the picture tube socket ground lead is connected, and then (b) touch the other end of the insulated clip lead to the picture tube anode button, using an insulating handle to avoid personal contact with high voltage.
 4. Do not spray chemicals on or near this receiver or any of its assemblies.
 5. Unless specified otherwise in this service manual, clean electrical contacts only by applying the following mixture to the contacts with a pipe cleaner, cotton-tipped stick or comparable non-abrasive applicator; 10% (by volume) Acetone and 90% (by volume) isopropyl alcohol (90%-99% strength)

CAUTION: This is a flammable mixture.

Unless specified otherwise in this service manual, lubrication of contacts is not required.

6. Do not defeat any plug/socket B+ voltage interlocks with which receivers covered by this service manual might be equipped.
7. Do not apply AC power to this instrument and/or any of its electrical assemblies unless all solid-state device heat sinks are correctly installed.
8. Always connect the test receiver ground lead to the receiver chassis ground before connecting the test receiver positive lead.
Always remove the test receiver ground lead last.

9. Use with this receiver only the test fixtures specified in this service manual.

CAUTION: Do not connect the test fixture ground strap to any heat sink in this receiver.

Electrostatically Sensitive (ES) Devices

Some semiconductor (solid-state) devices can be damaged easily by static electricity. Such components commonly are called *Electrostatically Sensitive (ES) Devices*. Examples of typical ES devices are integrated circuits and some field-effect transistors and semiconductor "chip" components. The following techniques should be used to help reduce the incidence of component damage caused by static by static electricity.

1. Immediately before handling any semiconductor component or semiconductor-equipped assembly, drain off any electrostatic charge on your body by touching a known earth ground. Alternatively, obtain and wear a commercially available discharging wrist strap device, which should be removed to prevent potential shock reasons prior to applying power to the unit under test.
2. After removing an electrical assembly equipped with ES devices, place the assembly on a conductive surface such as aluminum foil, to prevent electrostatic charge buildup or exposure of the assembly.
3. Use only a grounded-tip soldering iron to solder or unsolder ES devices.
4. Use only an anti-static type solder removal device. —Some solder removal devices not classified as "anti-static" can generate electrical charges sufficient to damage ES devices.
5. Do not use freon-propelled chemicals. These can generate electrical charges sufficient to damage ES devices.
6. Do not remove a replacement ES device from its protective package until immediately before you are ready to install it. (Most replacement ES devices are packaged with leads electrically shorted together by conductive foam, aluminum foil or comparable conductive material).
7. Immediately before removing the protective material from the leads of a replacement ES device, touch the protective material to the chassis or circuit assembly into which the device will be installed.
CAUTION: Be sure no power is applied to the chassis or circuit, and observe all other safety precautions.
8. Minimize bodily motions when handling unpackaged replacement ES devices. (Otherwise harmless motion such as the brushing together of your clothes fabric or the lifting of your foot from a carpeted floor can generate static electricity sufficient to damage an ES device.)

General Soldering Guidelines

1. Use a grounded-tip, low-wattage soldering iron and appropriate tip size and shape that will maintain tip temperature within the range of 500°F to 600°F.
2. Use an appropriate gauge of RMA resin-core solder composed of 60 parts tin/40 parts lead.
3. Keep the soldering iron tip clean and well tinned.
4. Thoroughly clean the surfaces to be soldered. Use a small wire-bristle (0.5 inch, or 1.25cm) brush with a metal handle.

Do not use freon-propelled spray-on cleaners.

5. Use the following unsoldering technique
 - a. Allow the soldering iron tip to reach normal temperature.
(500°F to 600°F)
 - b. Heat the component lead until the solder melts.
 - c. Quickly draw the melted solder with an anti-static, suction-type solder removal device or with solder braid.
6. Use the following soldering technique.
 - a. Allow the soldering iron tip to reach a normal temperature (500°F to 600°F)
 - b. First, hold the soldering iron tip and solder the strand against the component lead until the solder melts.

- c. Quickly move the soldering iron tip to the junction of the component lead and the printed circuit foil, and hold it there only until the solder flows onto and around both the component lead and the foil.

CAUTION: Work quickly to avoid overheating the circuit board printed foil.

- d. Closely inspect the solder area and remove any excess or splashed solder with a small wire-bristle brush.

IC Remove/Replacement

Some chassis circuit boards have slotted holes (oblong) through which the IC leads are inserted and then bent flat against the circuit foil. When holes are the slotted type, the following technique should be used to remove and replace the IC. When working with boards using the familiar round hole, use the standard technique as outlined in paragraphs 5 and 6 above.

Removal

1. Desolder and straighten each IC lead in one operation by gently prying up on the lead with the soldering iron tip as the solder melts.
2. Draw away the melted solder with an anti-static suction-type solder removal device (or with solder braid) before removing the IC.

Replacement

1. Carefully insert the replacement IC in the circuit board.
2. Carefully bend each IC lead against the circuit foil pad and solder it.
3. Clean the soldered areas with a small wire-bristle brush. (It is not necessary to reapply acrylic coating to the areas).

"Small-Signal" Discrete Transistor

Removal/Replacement

1. Remove the defective transistor by clipping its leads as close as possible to the component body.
2. Bend into a "U" shape the end of each of three leads remaining on the circuit board.
3. Bend into a "U" shape the replacement transistor leads.
4. Connect the replacement transistor leads to the corresponding leads extending from the circuit board and crimp the "U" with long nose pliers to insure metal to metal contact then solder each connection.

Power Output, Transistor Device

Removal/Replacement

1. Heat and remove all solder from around the transistor leads.
2. Remove the heat sink mounting screw (if so equipped).
3. Carefully remove the transistor from the heat sink of the circuit board.
4. Insert new transistor in the circuit board.
5. Solder each transistor lead, and clip off excess lead.
6. Replace heat sink.

Diode Removal/Replacement

1. Remove defective diode by clipping its leads as close as possible to diode body.
2. Bend the two remaining leads perpendicular y to the circuit board.
3. Observing diode polarity, wrap each lead of the new diode around the corresponding lead on the circuit board.
4. Securely crimp each connection and solder it.
5. Inspect (on the circuit board copper side) the solder joints of the two "original" leads. If they are not shiny, reheat them and if necessary, apply additional solder.

Fuse and Conventional Resistor

Removal/Replacement

1. Clip each fuse or resistor lead at top of the circuit board hollow stake.
2. Securely crimp the leads of replacement component around notch at stake top.
3. Solder the connections.

CAUTION: Maintain original spacing between the replaced component and adjacent components and the circuit board to prevent excessive component temperatures.

Circuit Board Foil Repair

Excessive heat applied to the copper foil of any printed circuit board will weaken the adhesive that bonds the foil to the circuit board causing the foil to separate from or "lift-off" the board. The following guidelines and procedures should be followed whenever this condition is encountered.

At IC Connections

To repair a defective copper pattern at IC connections use the following procedure to install a jumper wire on the copper pattern side of the circuit board. (Use this technique only on IC connections).

1. Carefully remove the damaged copper pattern with a sharp knife. (Remove only as much copper as absolutely necessary).
2. Carefully scratch away the solder resist and acrylic coating (if used) from the end of the remaining copper pattern.
3. Bend a small "U" in one end of a small gauge jumper wire and carefully crimp it around the IC pin. Solder the IC connection.
4. Route the jumper wire along the path of the out-away copper pattern and let it overlap the previously scraped end of the good copper pattern. Solder the overlapped area and clip off any excess jumper wire.

At Other Connections

Use the following technique to repair the defective copper pattern at connections other than IC Pins. This technique involves the installation of a jumper wire on the component side of the circuit board.

1. Remove the defective copper pattern with a sharp knife.
Remove at least 1/4 inch of copper, to ensure that a hazardous condition will not exist if the jumper wire opens.
2. Trace along the copper pattern from both sides of the pattern break and locate the nearest component that is directly connected to the affected copper pattern.
3. Connect insulated 20-gauge jumper wire from the lead of the nearest component on one side of the pattern break to the lead of the nearest component on the other side.

Carefully crimp and solder the connections.

CAUTION: Be sure the insulated jumper wire is dressed so the it does not touch components or sharp edges.

TIMING CHART

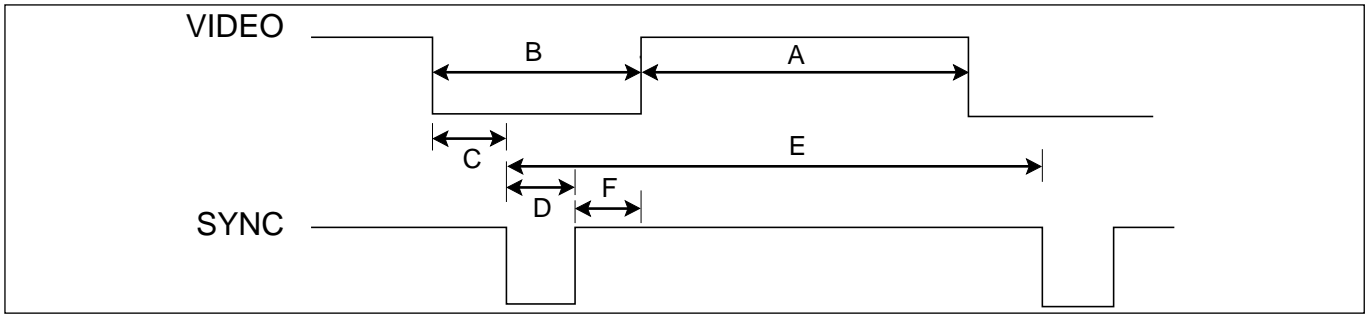

<< Dot Clock (MHz), Horizontal Frequency (kHz), Vertical Frequency (Hz), Horizontal etc... (μs), Vertical etc... (ms) >>

1) PC Mode

MODE	H / V	Sync Polarity	Dot Clock	Frequency	Total Period (E)	Video Active Time (A)	Front Porch (C)	Sync Duration (D)	Back Porch (F)	Resolution
1	H(Pixels)	+	25.175	31.469	800	640	16	96	48	640 x 350
	V(Lines)	-		70.8	449	350	37	2	60	
2	H(Pixels)	-	28.321	31.468	900	720	18	108	54	720 X 400
	V(Lines)	+		70.8	449	400	12	2	35	
3	H(Pixels)	-	25.175	31.469	800	640	16	96	48	640 x 480
	V(Lines)	-		59.94	525	480	10	2	33	
4	H(Pixels)	-	31.5	37.5	840	640	16	64	120	640 x 480
	V(Lines)	-		75	500	480	1	3	16	
5	H(Pixels)	-	36.0	43.269	832	640	56	56	80	640 x 480
	V(Lines)	-		85.0	509	480	1	3	25	
6	H(Pixels)	+	40.0	37.879	1056	800	40	128	88	800 x 600
	V(Lines)	+		60.317	628	600	1	4	23	
7	H(Pixels)	+	49.5	46.875	1056	800	16	80	160	800 x 600
	V(Lines)	+		75.0	625	600	1	3	21	
8	H(Pixels)	+	56.25	53.674	1048	800	32	64	152	800 x 600
	V(Lines)	+		85.061	631	600	1	3	27	
9	H(Pixels)	+/-	57.283	49.725	1152	832	32	64	224	832 x 624
	V(Lines)	+/-		74.55	667	624	1	3	39	
10	H(Pixels)	-	65.0	48.363	1344	1024	24	136	160	1024 x 768
	V(Lines)	-		60.0	806	768	3	6	29	
11	H(Pixels)	-	78.75	60.123	1312	1024	16	96	176	1024 x 768
	V(Lines)	-		75.029	800	768	1	3	28	
12	H(Pixels)	+	94.5	68.68	1376	1024	48	96	208	1024 x 768
	V(Lines)	+		85.00	808	768	1	3	36	
13	H(Pixels)	+	74.5	44.772	1664	1280	64	128	192	1280 x 720
	V(Lines)	+		59.855	748	720	3	5	20	
14	H(Pixels)	+	84.75	47.72	1776	1360	72	136	208	1360 x 768
	V(Lines)	+		59.799	798	768	3	5	22	
15	H(Pixels)	+	108.0	63.981	1688	1280	48	112	248	1280 x 1024
	V(Lines)	+		60.02	1066	1024	1	3	38	
16	H(Pixels)	+	135.00	79.98	1688	1280	16	144	248	1280 x 1024
	V(Lines)	+		75.02	1066	1024	1	3	38	
17	H(Pixels)	+	162.00	75.00	2160	1600	90	30	88	1600 x 1200
	V(Lines)	+		60	1250	1200	1	3	46	

※ 1~17 : D-SUB, 1~17 : DVI-D : 1~15

2) Component Video Mode(Y/Pb/Pr)

MODE	H / V	Sync Polarity	Dot Clock	Frequency	Total Period (E)	Video Active Time (A)	Front Porch (C)	Sync Duration (D)	Back Porch (F)	Resolution
1	H(Pixels)	-	25.175	31.469	800	640	16	96	48	SDTV
	V(Lines)	-		59.94	525	480	10	2	33	480P
2	H(Pixels)	-	27.027	31.5	858	720	16	62	60	HDTV
	V(Lines)	-		60	525	480	10	2	33	720P(HDCP)
3	H(Pixels)	-	74.176	44.955	1650	1280	70	40	260	HDTV
	V(Lines)	-		59.94	750	720	5	5	60	720P(HDCP)
4	H(Pixels)	-	74.250	33.750	2200	1920	44	44	192	HDTV
	V(Lines)	-		60.053	562	540	2	5	15	1080I(HDCP)
5	H(Pixels)	-	74.176	33.716	2200	1920	44	44	192	HTDV
	V(Lines)	-		59.994	562	540	2	5	15	1080I(HDCP)

BLOCK DIAGRAM(uPD64011+gm1501H)

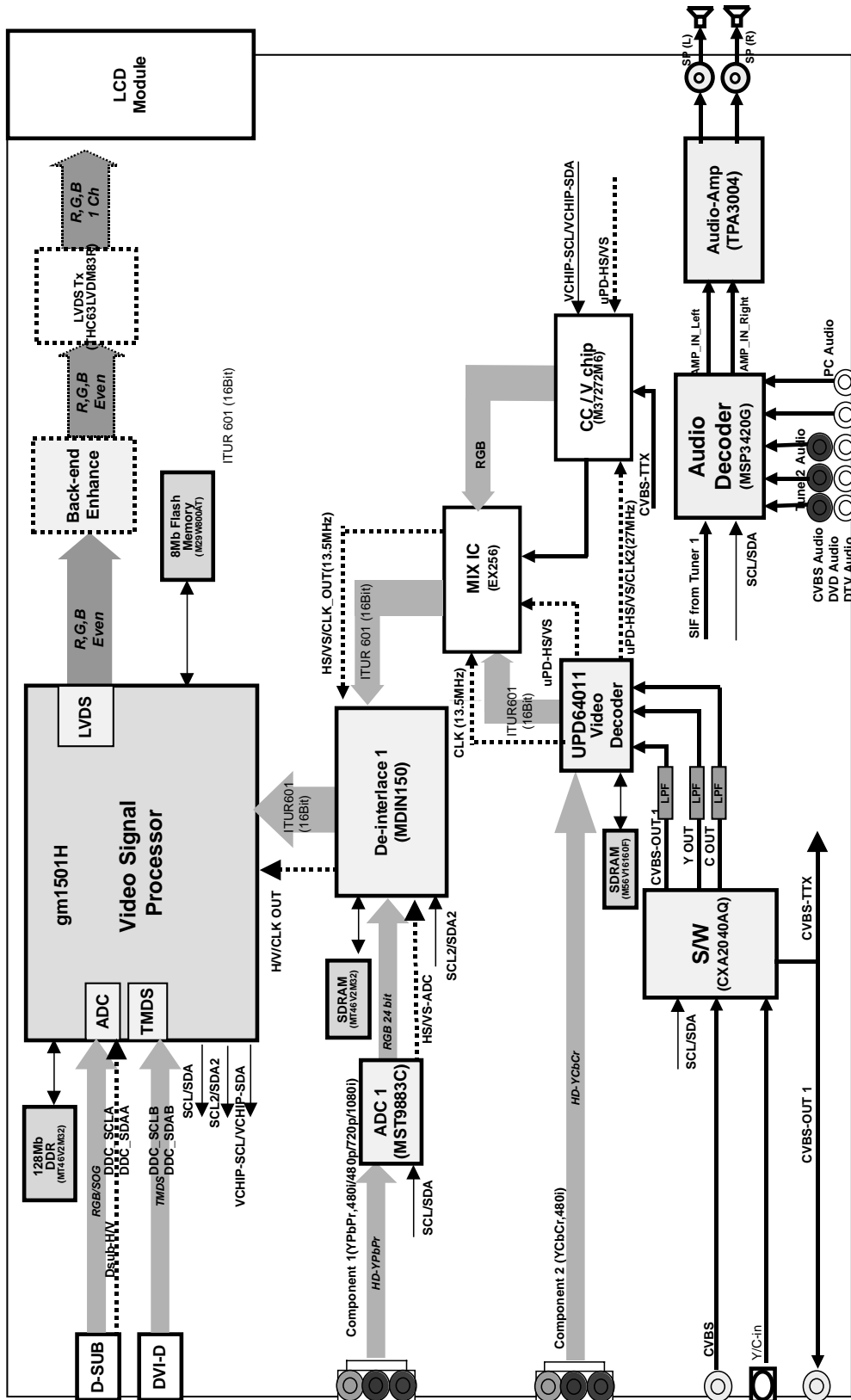

DESCRIPTION OF BLOCK DIAGRAM

1. Input Selection Circuit

1) PC Input Selection

This block is composed of GM1501(U402) and peripheral devices.

2) Video Input Selection

This block is composed of video S/W IC (CXA2040Q, U201) and peripheral devices. There are two inputs in CXA2040Q IC(Video input CVBS, S-video signal). One selected video signal is transmitted a video decoder IC (UPD64011, U904)

2. DDC controller

This block is composed of GM1501(U402) and peripheral EEPROM IC(U114,U115). GM1501(U402) controls peripheral devices through IIC line.

Major functions are (1) to control Flash memory through DDC-SCLA, DDC-SDAA of D-sub and (2) to store EDID data in the EEPROM (U114,U115).

3. Video Decoder

This block is composed of UPD64011 (U904) and peripheral devices.

GM 1501 controls this IC through IIC Line.

This IC analyzes input signal of CVBS, Y/C and output analyzed signal (16bit interlace signal) to De-interlace block.

Analyzed signal has video control signals like Contrast, Brightness, Sharpness, Color, tint signals Including Adaptive Comb Filter.

4. Audio Decoder

This block is composed of MSP3420G (U501) and peripheral devices.

GM 1501 controls this IC through IIC Line.

This IC analyzes audio input signal through A/V Jack and PC audio.

The analyzed signals transmitted to audio amplifier (TPA3004, U502).

5. Audio Amplifier

This block is composed of TPA3004 (U502) and peripheral devices.

The function of the audio amplifier is that to amplify audio L/R signal transmitted from audio decoder. The audio signal is amplified according to pre-defined DC volume control curve.

6. De-interlacer

This block is composed of MDIN150(U901) and peripheral devices.

GM1501 (U402) controls this IC through IIC Line.

And this IC converts 16 Bit Interlaced Y/UV signal to De-interlaced signal.

It output converted signal to Format Converter IC(GM 1501, U402).

7. Format Converter

This block is composed of GM 1501(U402) and peripheral devices. GM 1501(Scaler,U402) contains MICOM.

1) This IC contain A/D converter, Pre-amp and PLL circuit that converting analog video signal(0.7Vp-p) through D-sub(J101) Pin to digital signal.

2) This IC Decode TMDS signals of 8 line from DVI-D Pin (J102) and transmit to LVDS Transmitter.

GM 1501 is Format Converter IC that receives Digital signal and outputs proper frame signal to LCD Module Timing(1366x768,WXGA).

8. DC/DC Converter block

DC/DC Converter convert the input 12V, 24V to proper 2.5V, 3.3V, 5V, 1.8V for main control system.

For shooting heat trouble, we use the DC/DC converting IC.

9. Caption/V-CHIP block -Only U.S.A

This block is composed of M37272(U1001) and peripheral devices. M37272 IC is useful for channel selection system for TV with a closed caption decoder.

10. Power Supply Block

This Block generates DC Voltages(12V, 24V) to Main Control system from AC Power(100-240 V, 50/60 Hz, 2.8 A).

This Circuit contains PFC(Power Factor correction) circuit.

The Minimum of Power efficiency is about 75%.

ADJUSTMENT

All adjustment are thoroughly checked and corrected when the monitor leaves the factory, but sometimes several minor adjustment may be required. Adjustment should be following procedure and after warming up for a minimum of 30 minutes.

- Alignment appliances and tools.
 - IBM compatible PC
 - Programmable Signal Generator. (eg. VG-819 made by Astrodesign Co.)
 - Oscilloscope.
 - White Balance Meter. (CA-110)

1. DDC Data Write Procedure-Analog

- 1) Use this procedure only when there is some problem on Analog EDID data.
- 2) Run alignment program for L3200TC on the IBM compatible PC.
- 3) Select EEPROM → Analog EDID write command and Enter.
- 4) This will write the Analog EDID data to EEPROM.

2. DDC Data Write Procedure-Digital

- 1) Use this procedure only when there is some problem on Digital EDID data.
- 2) Run alignment program for L3200TC on the IBM compatible PC.
- 3) Select EEPROM → Digital EDID write command and Enter.
- 4) This will write the Digital EDID data to EEPROM.

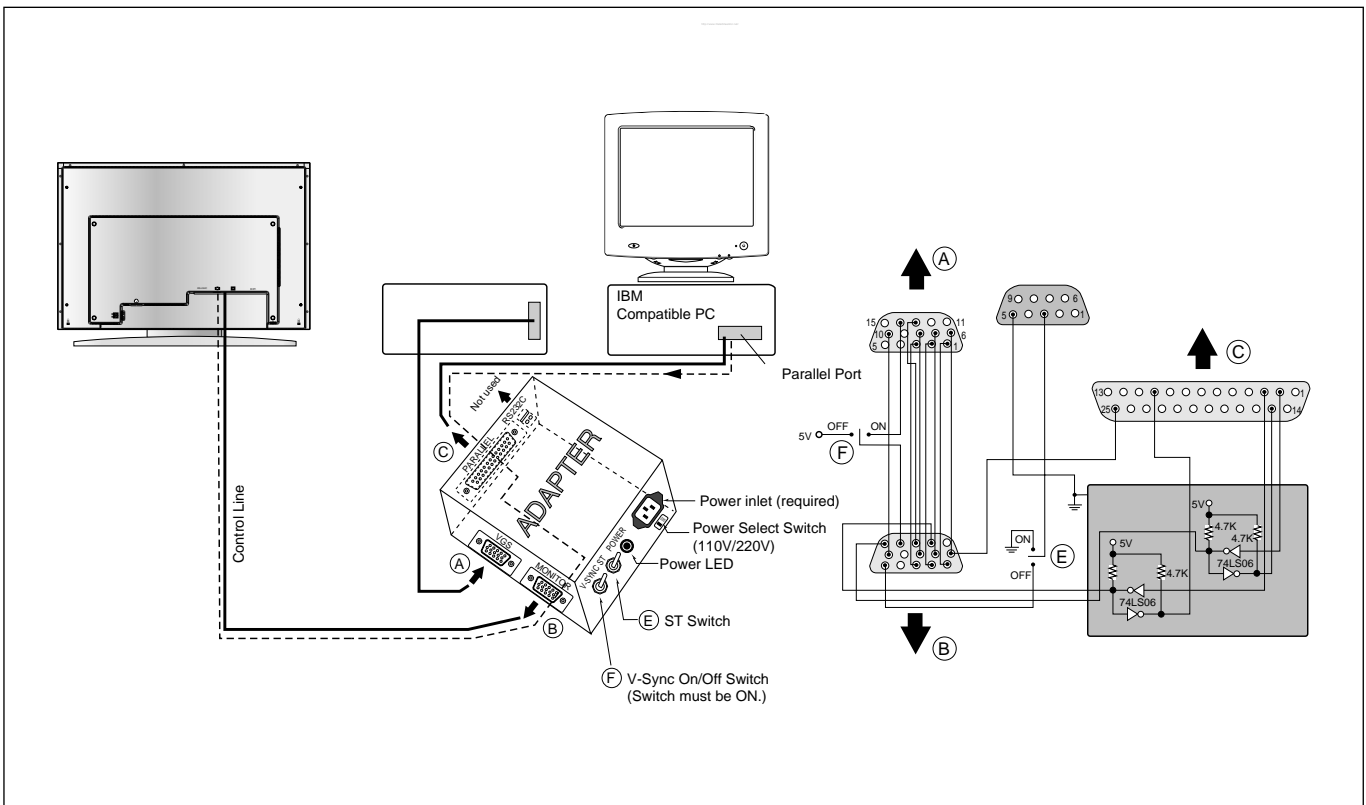

Figure 1. Cable Connection

Windows EDID V1.0 User Manual

Operating System: MS Windows 98, 2000, XP
 Port Setup: Windows 98 => Don't need setup
 Windows 2000, XP => Need to Port Setup.
 This program is available to LCD Monitor only.

1. Port Setup

- a) Copy "UserPort.sys" file to "c:\WINNT\system32\drivers" folder
- b) Run Userport.exe

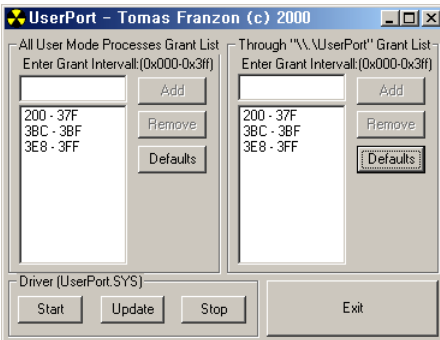

- c) Remove all default number
- d) Add 300-3FF

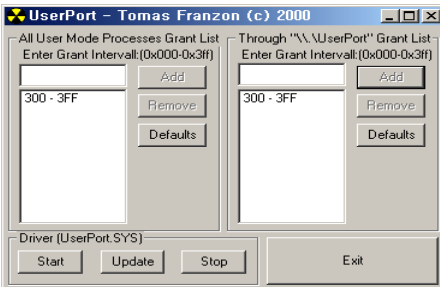

- e) Click Start button.
- f) Click Exit button.

2. EDID Read & Write

1) Run WinEDID.exe

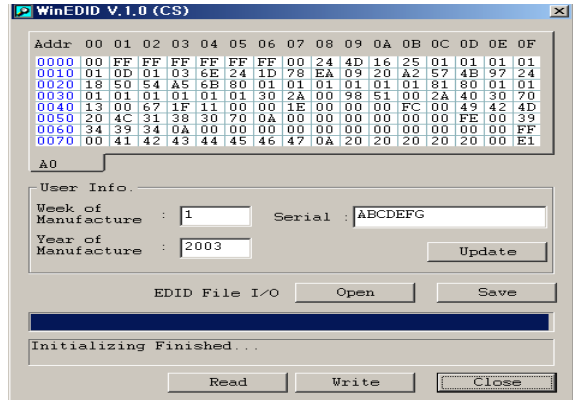

2) Edit Week of Manufacture, Year of Manufacture, Serial Number

- a) Input User Info Data
- b) Click "Update" button
- c) Click "Write" button

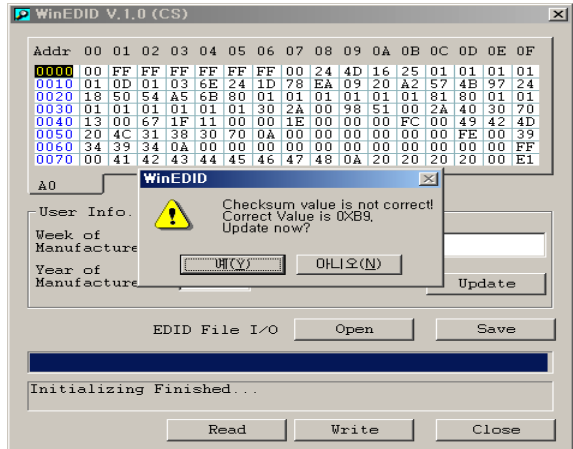

SERVICE OSD

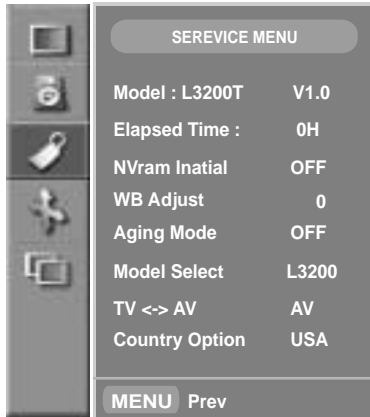

- Service Menu
 - Model : Model or Micom Version
 - Elapsed time : Time used for panel
 - Nvram Initial : EEPROM reset and use Default Data
 - WB Adjust : Adjusts the white balance
 - Aging Mode : Sets the aging mode (User : OFF)
 - Model Select : Use the sizes Model change
 - TV <-> AV : TV Model, AV Model change
 - Contry Option : Chooses a country

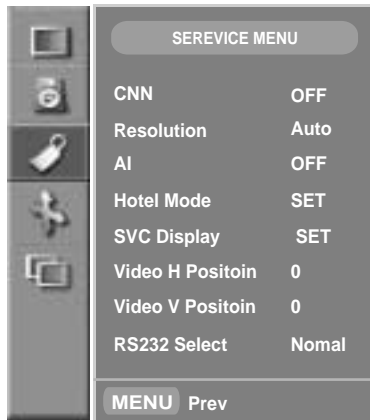

- CNN : Use the CNN Option (only CNN version ON)
- Resolution : Adjusts the picture resolution
- AI : Function built in panel
- Hotel Mode : Enters with the menu which sets a hotel mode
- SVC Display : Color of video input at regulation hour use
- Video H Position : Horizontality position of video input at the change
- Video V Position : Verticality position of video input at the change
- RS232 Select : Change RS232 Protocol

TROUBLESHOOTING GUIDE

1. NO POWER

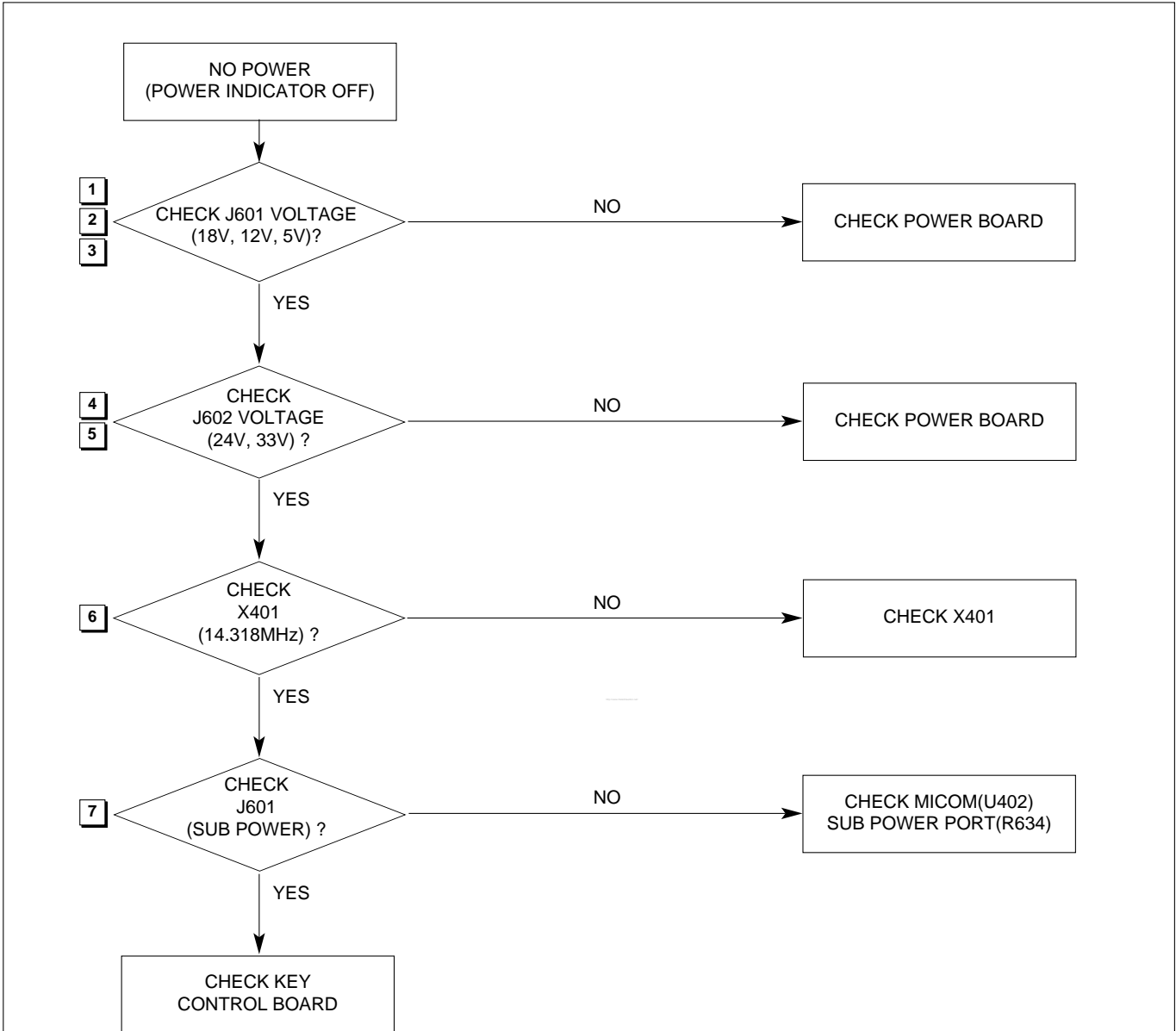

Waveforms

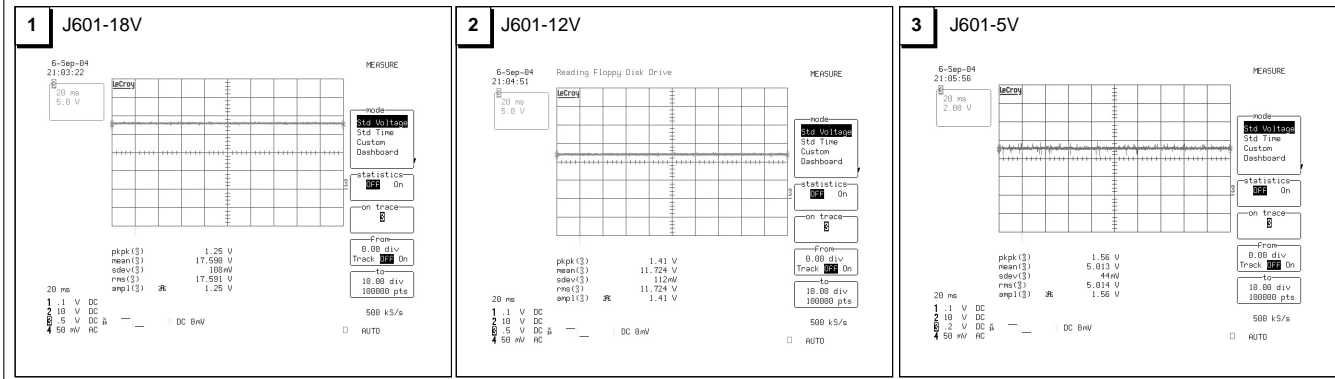

Waveforms

4 J602-24V

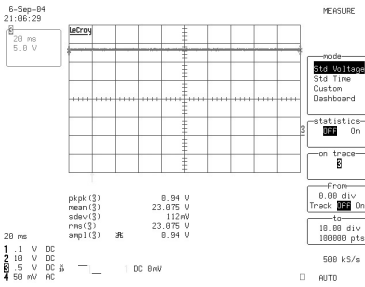

5 J602-33V

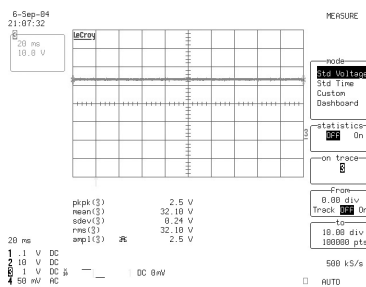

6 X401-14.318MHz

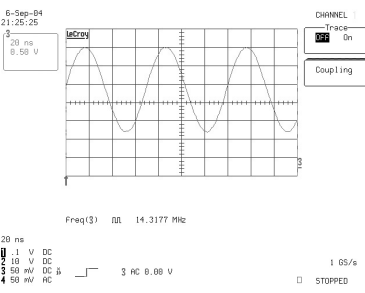

7 J601

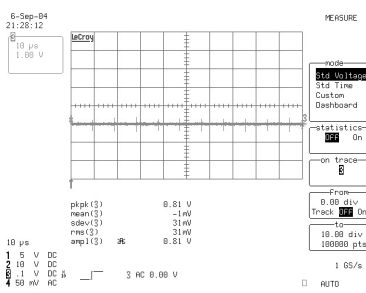

2. NO RASTER(OSD IS NOT DISPLAYED)

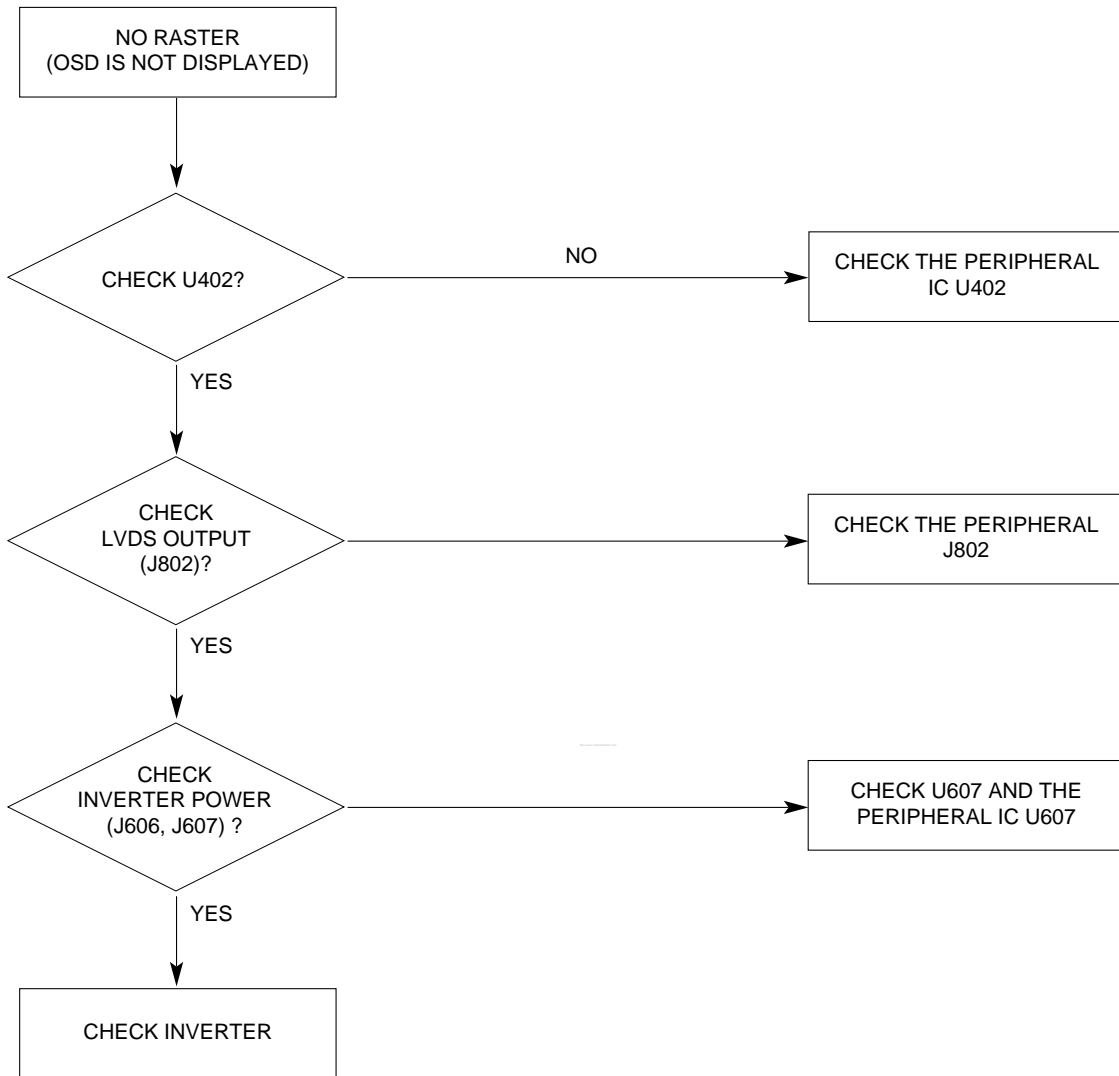

3. NO RASTER ON VIDEO SIGNAL INPUT

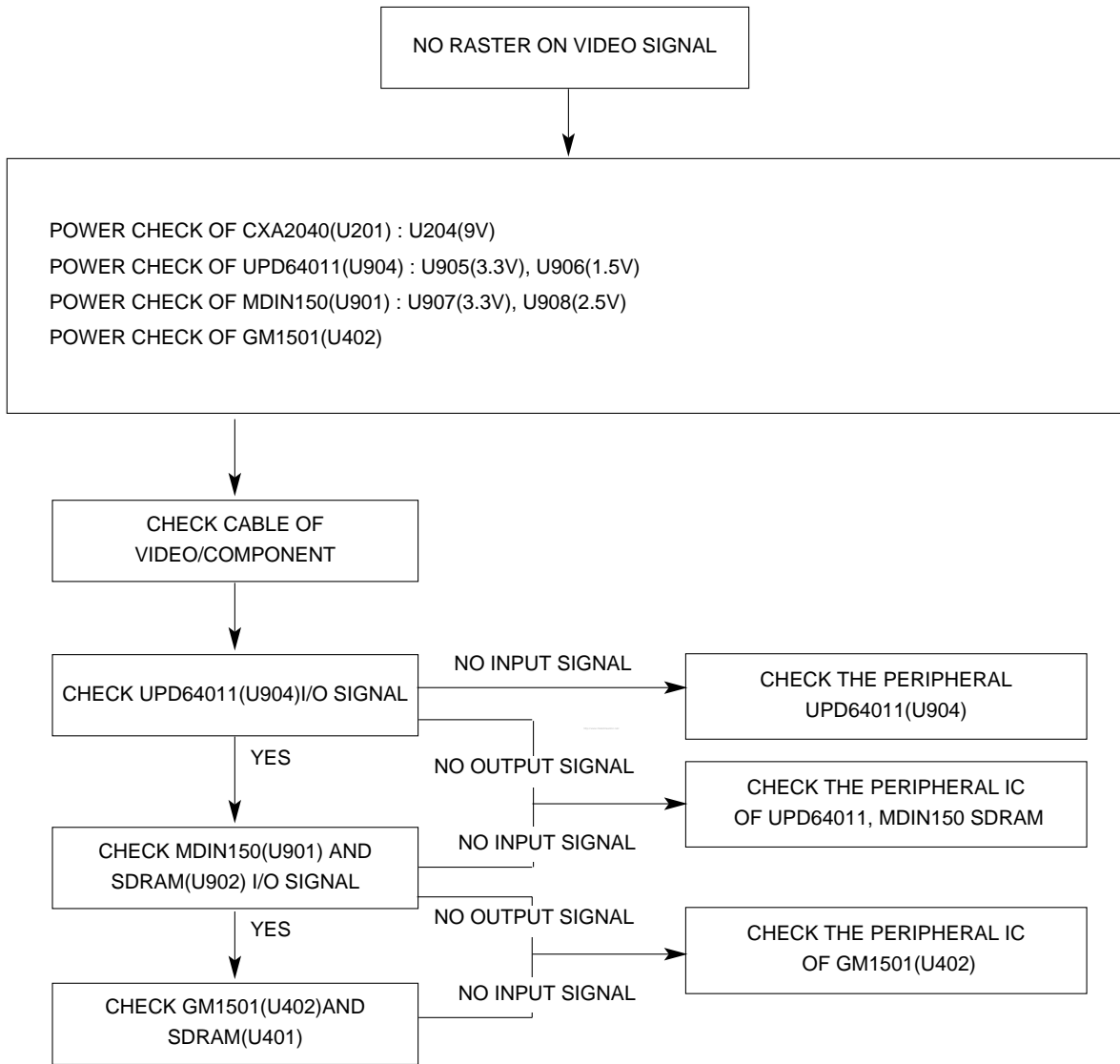

4. SOUND TROUBLE SHOOTING

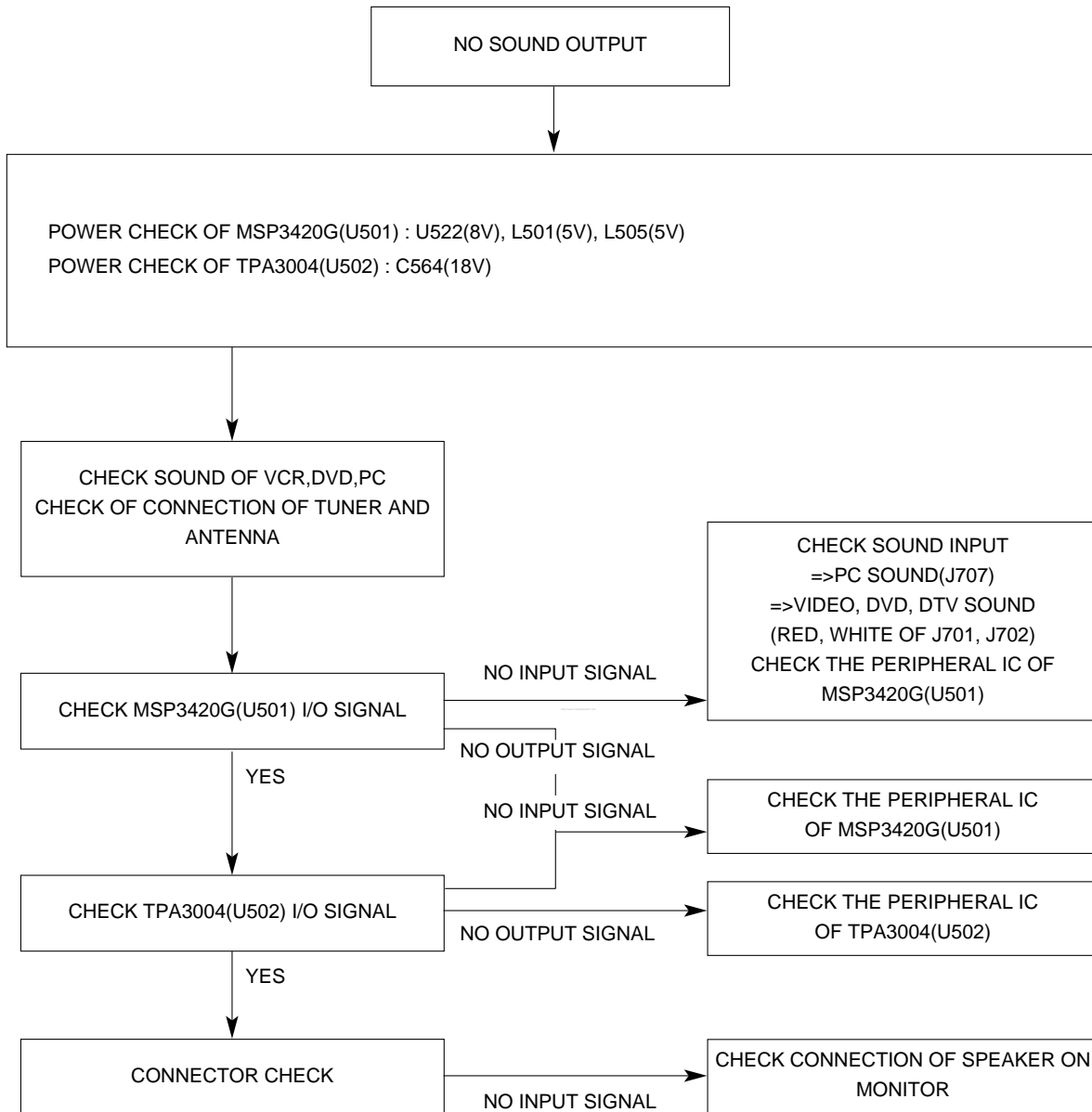

5. NO RASTER STATE ON ANALOG SIGNAL

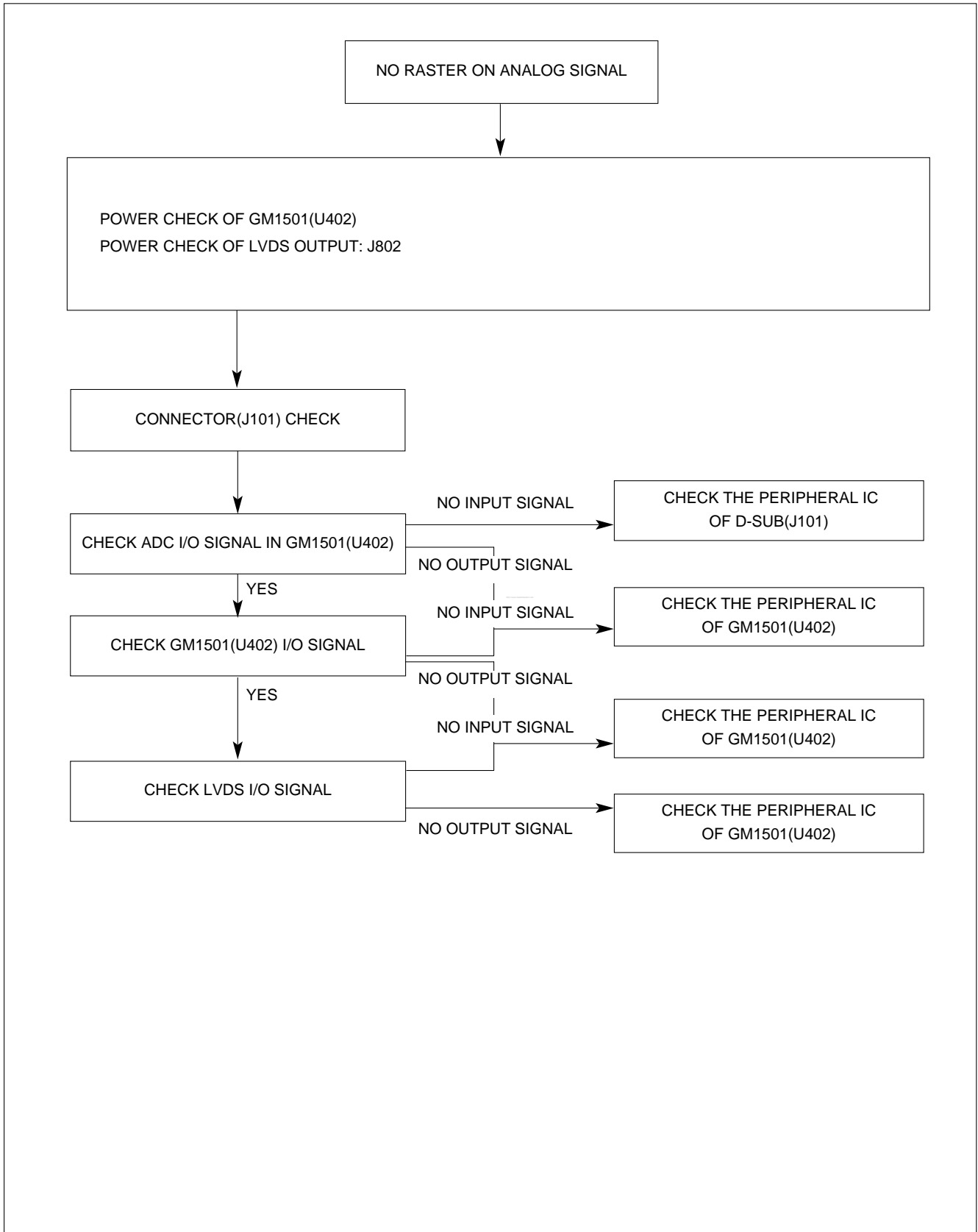

6. NO RASTER STATE ON DIGITAL SIGNAL

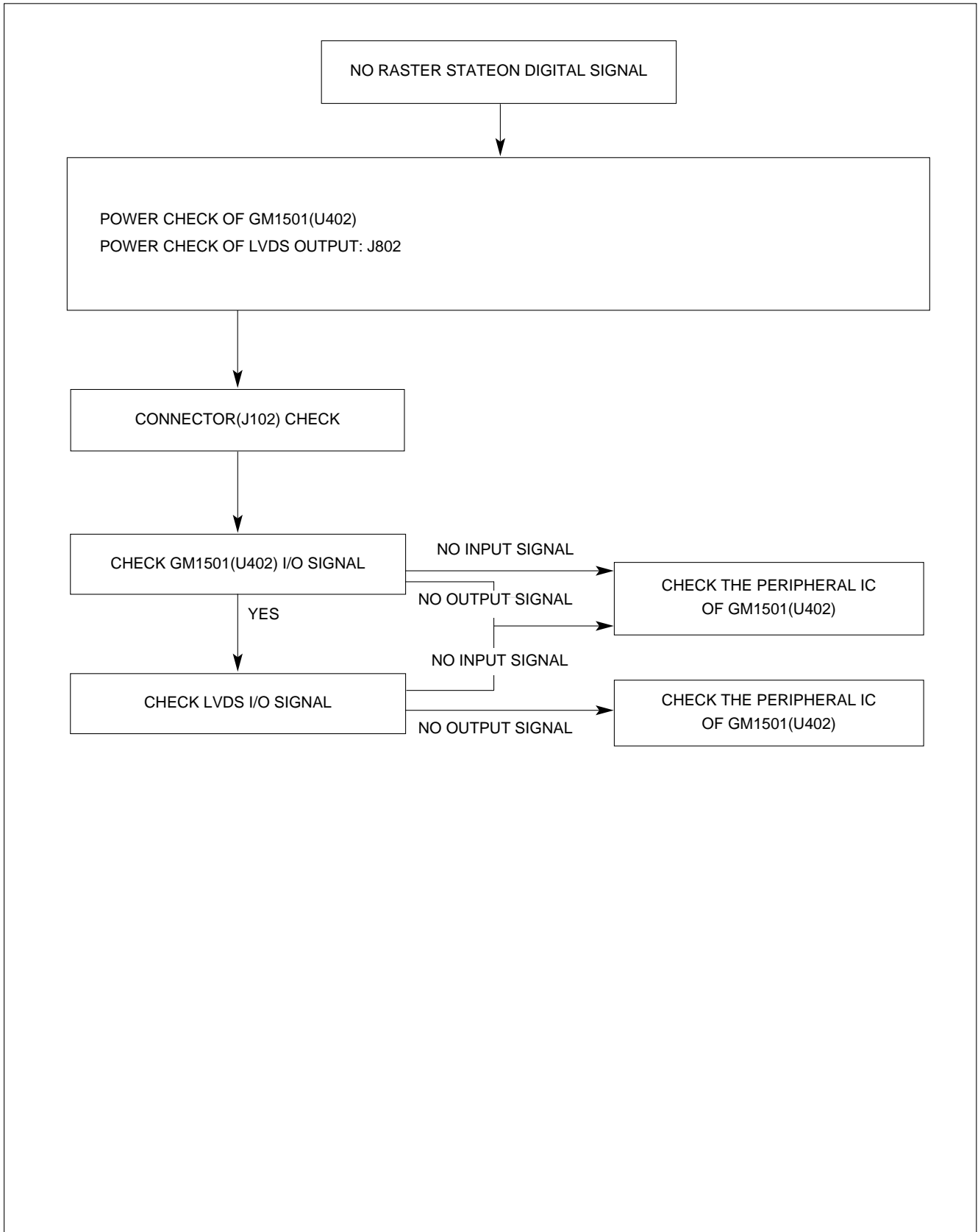

WIRING DIAGRAM

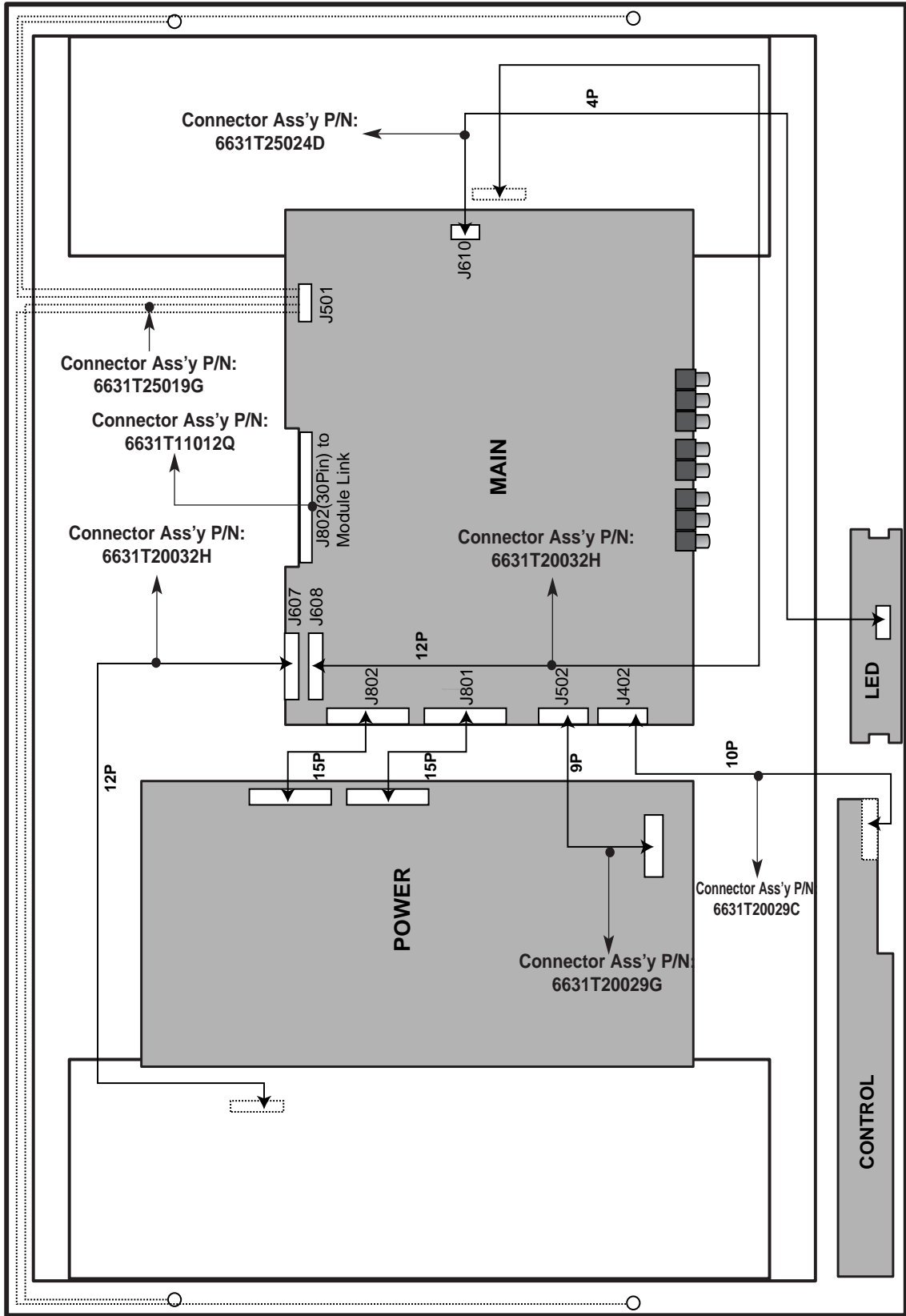

EXPLODED VIEW

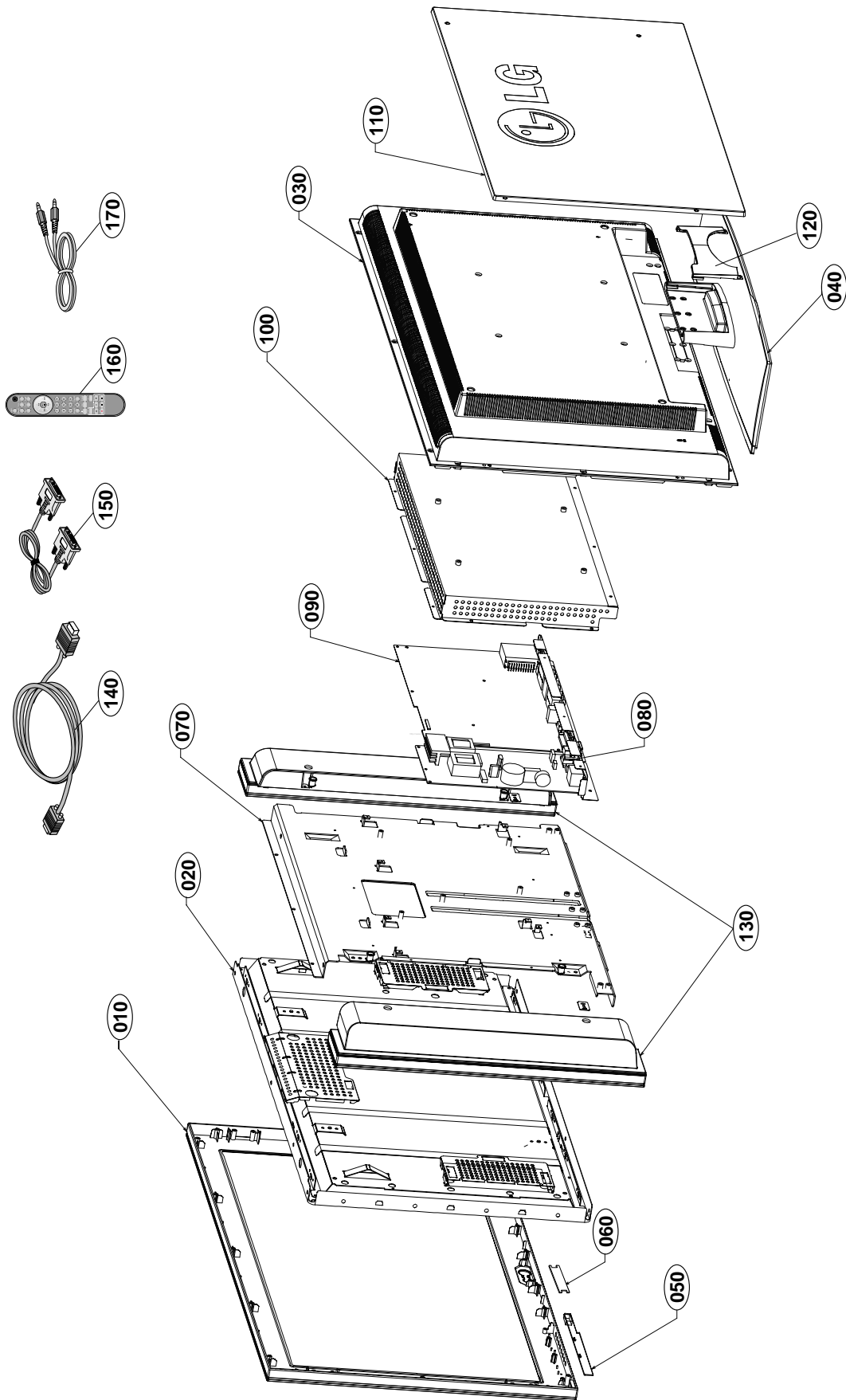

EXPLODED VIEW PARTS LIST

Ref. No.	Part No.	Description
010	3091TKE022C	CABINET ASSEMBLY, L3200A BRAND 3090TKE018 -AV- SILVER
	3091TKE022H	CABINET ASSEMBLY, L3200A BRAND 3090TKE018 -AV- BLACK
020	6304FLP163A	LCD(LIQUID CRYSTAL DISPLAY), LC320W01-A6 LG PHILIPS TFT COLOR WXGA, 16:9, 500NITS, 16MS, 8BIT, LVDS
	or 6304FLP215A	LCD(LIQUID CRYSTAL DISPLAY), LC320W01-A6K4 LG PHILIPS TFT COLOR LEAD FREE
030	3809TKE021C	BACK COVER ASSEMBLY, L3200A 3808TKE019 -AV
040	3043TKK213A	TILT SWIVEL ASSEMBLY, L3200A 4950TKK983 STAND- Only L3200ATC,L3200AFC
050	6871TST481D	PWB(PCB) ASSEMBLY,SUB, L3200TC CONTROL TOTAL BRAND CL-70 (WITHOUT COIL - FOR CHAMELEON)
060	6871TST786A	PWB(PCB) ASSEMBLY,SUB, L3200TFC LED & P/SW TOTAL BRAND LED (LOGO)
070	4951TKS198C	METAL ASSEMBLY, FRAME LPL-MAIN-L3200A
080	6871TPT298A	PWB(PCB) ASSEMBLY,POWER, L3200AC POWER TOTAL BRAND MFM POWER(YU YANG) FOR LPL
090	3313TL3018A	MAIN TOTAL ASSEMBLY, L3200AC AV BRAND CL-70
100	4814TKK286A	SHIELD, REAR _SHIELD_L3200A
110	3551TKK548A	COVER ASSEMBLY, L3200A REAR 3550TKK632 DECO COVER- Only L3200ATC,L3200AFC
120	3550TKK635A	COVER, L3200A STAND REAR- Only L3200ATC,L3200AFC
130	3551TKS056A	COVER ASSEMBLY, L3200A SPEAKER 3550TKS103 32INCH SPEAKER- Only L3200AFC
140	6850TD9001J	CABLE,D-SUB, UL 2990-9C(7.5) DT 1870MM PEARL WH T541K DM-SILVER- SILVER
	or 6850TD9007E	CABLE,D-SUB, UL20276-9C(5.8MM) DT L1800,CORE POS400,,S/HEADMM GRAY(85964) BRAND DM
	6850TD9001K	CABLE,D-SUB, UL 2990-9C(7.5) DT 1870MM STEALTH BLACK T541 DM
150	6866TDV004R	CABLE,DVI, UL20276(7.5MM) DT 2000MM GRAY(85964) 20 MODEL DM- SILVER
	6866TDV004J	CABLE,DVI, UL20276 DT 2000MM BLACK (9930) LG883D DM
160	6710T00003G	REMOTE CONTROLLER, L3020AL ALUST NTSC 30" AV/TV
	or 6710T00003B	REMOTE CONTROLLER, L2320A OVERSEAS NTSC NTSC REMOTE CONTROLLER
170	6852TAZ006J	CORD,A/V, A/V KHC-LG-3-0010 UL 2851 #28-2C 1500MM BLACK(9930) KSD WITH CORE LM295B

REPLACEMENT PARTS LIST

CAUTION: BEFORE REPLACING ANY OF THESE COMPONENTS,
 READ CAREFULLY THE **SAFETY PRECAUTIONS** IN THIS MANUAL.

* NOTE : **S** SAFETY Mark
AL ALTERNATIVE PARTS

DATE: 2005. 05. 19.				
*S	*AL	LOC. NO.	PART NO.	DESCRIPTION / SPECIFICATION
MAIN BOARD				
CAPACITORS				
			C1007	0CK104CK56A 0.1UF 1608 50V 10% R/TP X7R
			C1008	0CC101CK41A 100PF 1608 50V 5% R/TP NP0
			C1009	0CC101CK41A 100PF 1608 50V 5% R/TP NP0
			C1014	0CH3105H946 "1UF 25V 80%,-20% F(Y5V) 2012"
			C1015	0CH6102K406 1000PF 50V J SL 2012 R/TP
			C1016	0CK104CK56A 0.1UF 1608 50V 10% R/TP X7R
			C1017	0CH6221K416 220PF 50V J NP0 2012 R/TP
			C1018	0CC471CK41A 470PF 1608 50V 5% R/TP NP0
			C1019	0CH3103K516 10000PF 50V 10% B(Y5P) 2012
			C1020	0CC180CK41A 18PF 1608 50V 5% R/TP NP0
			C1021	0CC180CK41A 18PF 1608 50V 5% R/TP NP0
			C1022	0CE107WF6DC 100UF MVK 16V 20% R/TP(SMD)
			C1026	0CE107WF6DC 100UF MVK 16V 20% R/TP(SMD)
			C1027	0CH3103K516 10000PF 50V 10% B(Y5P) 2012
			C1049	0CH3104K566 0.1UF 50V 10% X7R 2012 R/TP
			C1050	0CH3104K566 0.1UF 50V 10% X7R 2012 R/TP
			C1052	0CH8106F691 10UF 16V 20% 105STD (CYL) R/
			C1055	0CH3104K566 0.1UF 50V 10% X7R 2012 R/TP
			C1056	0CK104CK56A 0.1UF 1608 50V 10% R/TP X7R
			C1059	0CH3104K566 0.1UF 50V 10% X7R 2012 R/TP
			C1060	0CH3104K566 0.1UF 50V 10% X7R 2012 R/TP
			C1061	0CH8106F691 10UF 16V 20% 105STD (CYL) R/
			C1062	0CH3104K566 0.1UF 50V 10% X7R 2012 R/TP
			C1063	0CK104CK56A 0.1UF 1608 50V 10% R/TP X7R
			C108	0CK103CK51A 0.01UF 1608 50V 10% R/TP B(Y
			C109	0CK103CK51A 0.01UF 1608 50V 10% R/TP B(Y
			C112	0CC101CK41A 100PF 1608 50V 5% R/TP NP0
			C113	0CK104CK56A 0.1UF 1608 50V 10% R/TP X7R
			C115	0CK103CK51A 0.01UF 1608 50V 10% R/TP B(Y
			C117	0CC101CK41A 100PF 1608 50V 5% R/TP NP0
			C123	0CC101CK41A 100PF 1608 50V 5% R/TP NP0
			C125	0CC270CK41A 27PF 1608 50V 5% R/TP NP0
			C126	0CC270CK41A 27PF 1608 50V 5% R/TP NP0
			C127	0CC270CK41A 27PF 1608 50V 5% R/TP NP0
			C128	0CK224CF56A 0.22UF 1608 16V 10% R/TP X7R
			C129	0CK224CF56A 0.22UF 1608 16V 10% R/TP X7R
			C130	0CK224CF56A 0.22UF 1608 16V 10% R/TP X7R
			C131	0CK224CF56A 0.22UF 1608 16V 10% R/TP X7R
			C134	0CK224CF56A 0.22UF 1608 16V 10% R/TP X7R
			C135	0CK224CF56A 0.22UF 1608 16V 10% R/TP X7R
			C137	0CK224CF56A 0.22UF 1608 16V 10% R/TP X7R
			C138	0CK224CF56A 0.22UF 1608 16V 10% R/TP X7R
			C140	0CC101CK41A 100PF 1608 50V 5% R/TP NP0
			C141	0CK104CK56A 0.1UF 1608 50V 10% R/TP X7R
			C142	0CK104CK56A 0.1UF 1608 50V 10% R/TP X7R
			C143	0CC101CK41A 100PF 1608 50V 5% R/TP NP0
			C144	0CK103CK51A 0.01UF 1608 50V 10% R/TP B(Y
			C201	0CH8106F691 10UF 16V 20% 105STD (CYL) R/
			C202	0CH3104K566 0.1UF 50V 10% X7R 2012 R/TP
			C203	0CK104CK56A 0.1UF 1608 50V 10% R/TP X7R
			C204	0CC151CK41A 150PF 1608 50V 5% NP0 R/TP
			C212	0CE225VK6DC 2.2UF MV 50V 20% R/TP(SMD) S

DATE: 2005. 05. 19.				
*S	*AL	LOC. NO.	PART NO.	DESCRIPTION / SPECIFICATION
			C222	0CE335VK6DC 3.3UF MV 50V 20% R/TP(SMD) S
			C225	0CH8336H611 33UF 25V M 85STD(CYL) R/TP
			C226	0CK103CK51A 0.01UF 1608 50V 10% R/TP B(Y
			C227	0CE225VK6DC 2.2UF MV 50V 20% R/TP(SMD) S
			C228	0CE225VK6DC 2.2UF MV 50V 20% R/TP(SMD) S
			C229	0CK104CK56A 0.1UF 1608 50V 10% R/TP X7R
			C231	0CH6680K416 68PF 50V J NP0 2012 R/TP
			C233	0CE227VF6DC 220UF MV 16V 20% R/TP(SMD) S
			C234	0CK103CK51A 0.01UF 1608 50V 10% R/TP B(Y
			C238	0CE227VF6DC 220UF MV 16V 20% R/TP(SMD) S
			C243	0CH3103K516 10000PF 50V 10% B(Y5P) 2012
			C244	0CH3104K566 0.1UF 50V 10% X7R 2012 R/TP
			C249	0CH3103K516 10000PF 50V 10% B(Y5P) 2012
			C256	0CE475VK6DC 4.7UF MV 50V 20% R/TP(SMD) S
			C257	0CE107WF6DC 100UF MVK 16V 20% R/TP(SMD)
			C269	0CC270DK41A 27PF 2012 50V 5% NP0 R/TP
			C270	0CC270DK41A 27PF 2012 50V 5% NP0 R/TP
			C288	0CH8226F691 22UF 16V 20% 105STD (CYL) R/
			C289	0CH3104K566 0.1UF 50V 10% X7R 2012 R/TP
			C290	0CH3104K566 0.1UF 50V 10% X7R 2012 R/TP
			C291	0CH8226F691 22UF 16V 20% 105STD (CYL) R/
			C292	0CH3104K566 0.1UF 50V 10% X7R 2012 R/TP
			C293	0CH3104K566 0.1UF 50V 10% X7R 2012 R/TP
			C294	0CH3103K516 10000PF 50V 10% B(Y5P) 2012
			C295	0CH3103K516 10000PF 50V 10% B(Y5P) 2012
			C298	0CH3103K516 10000PF 50V 10% B(Y5P) 2012
			C304	0CH8106F691 10UF 16V 20% 105STD (CYL) R/
			C316	0CK104CK56A 0.1UF 1608 50V 10% R/TP X7R
			C317	0CK104CK56A 0.1UF 1608 50V 10% R/TP X7R
			C318	0CK473CK56A 47000PF 1608 50V 10% R/TP X7
			C319	0CK473CK56A 47000PF 1608 50V 10% R/TP X7
			C320	0CH3104K566 0.1UF 50V 10% X7R 2012 R/TP
			C340	0CC102CK41A 1000PF 1608 50V 5% R/TP NP0
			C341	0CK473CK56A 47000PF 1608 50V 10% R/TP X7
			C342	0CK473CK56A 47000PF 1608 50V 10% R/TP X7
			C346	0CK104CK56A 0.1UF 1608 50V 10% R/TP X7R
			C347	0CK473CK56A 47000PF 1608 50V 10% R/TP X7
			C348	0CK473CK56A 47000PF 1608 50V 10% R/TP X7
			C349	0CH8106F691 10UF 16V 20% 105STD (CYL) R/
			C358	0CK104CK56A 0.1UF 1608 50V 10% R/TP X7R
			C360	0CK104CK56A 0.1UF 1608 50V 10% R/TP X7R
			C365	0CK104CK56A 0.1UF 1608 50V 10% R/TP X7R
			C366	0CH8106F691 10UF 16V 20% 105STD (CYL) R/
			C368	0CK104CK56A 0.1UF 1608 50V 10% R/TP X7R
			C369	0CH3104K566 0.1UF 50V 10% X7R 2012 R/TP
			C370	0CH3104K566 0.1UF 50V 10% X7R 2012 R/TP
			C373	0CH3104K566 0.1UF 50V 10% X7R 2012 R/TP
			C376	0CK104CK56A 0.1UF 1608 50V 10% R/TP X7R
			C377	0CH3104K566 0.1UF 50V 10% X7R 2012 R/TP
			C379	0CH3104K566 0.1UF 50V 10% X7R 2012 R/TP
			C381	0CK104CK56A 0.1UF 1608 50V 10% R/TP X7R
			C382	0CK104CK56A 0.1UF 1608 50V 10% R/TP X7R
			C401	0CH3104K566 0.1UF 50V 10% X7R 2012 R/TP
			C402	0CK104CK56A 0.1UF 1608 50V 10% R/TP X7R

DATE: 2005. 05. 19.				
*S	*AL	LOC. NO.	PART NO.	DESCRIPTION / SPECIFICATION
		C403	0CK103CK51A	0.01UF 1608 50V 10% R/TP B(Y
		C404	0CK103CK51A	0.01UF 1608 50V 10% R/TP B(Y
		C405	0CK103CK51A	0.01UF 1608 50V 10% R/TP B(Y
		C406	0CK104CK56A	0.1UF 1608 50V 10% R/TP X7R
		C407	0CH8226F69I	22UF 16V 20% 105STD (CYL) R/
		C408	0CH3104K566	0.1UF 50V 10% X7R 2012 R/TP
		C409	0CK104CK56A	0.1UF 1608 50V 10% R/TP X7R
		C410	0CE335VK6DC	3.3UF MV 50V 20% R/TP(SMD) S
		C4101	0CH3104K566	0.1UF 50V 10% X7R 2012 R/TP
		C411	0CK104CK56A	0.1UF 1608 50V 10% R/TP X7R
		C412	0CK104CK56A	0.1UF 1608 50V 10% R/TP X7R
		C413	0CK104CK56A	0.1UF 1608 50V 10% R/TP X7R
		C414	0CK104CK56A	0.1UF 1608 50V 10% R/TP X7R
		C415	0CK104CK56A	0.1UF 1608 50V 10% R/TP X7R
		C416	0CK104CK56A	0.1UF 1608 50V 10% R/TP X7R
		C417	0CK104CK56A	0.1UF 1608 50V 10% R/TP X7R
		C418	0CH3104K566	0.1UF 50V 10% X7R 2012 R/TP
		C420	0CK104CK56A	0.1UF 1608 50V 10% R/TP X7R
		C427	0CK104CK56A	0.1UF 1608 50V 10% R/TP X7R
		C428	0CK104CK56A	0.1UF 1608 50V 10% R/TP X7R
		C429	0CC150CK41A	15PF 1608 50V 5% R/TP NP0
		C435	0CK104CK56A	0.1UF 1608 50V 10% R/TP X7R
		C459	0CK104CK56A	0.1UF 1608 50V 10% R/TP X7R
		C460	0CK104CK56A	0.1UF 1608 50V 10% R/TP X7R
		C461	0CK104CK56A	0.1UF 1608 50V 10% R/TP X7R
		C462	0CK104CK56A	0.1UF 1608 50V 10% R/TP X7R
		C463	0CC220CK41A	22PF 1608 50V 5% R/TP NP0
		C464	0CC220CK41A	22PF 1608 50V 5% R/TP NP0
		C468	0CH3104K566	0.1UF 50V 10% X7R 2012 R/TP
		C469	0CH3104K566	0.1UF 50V 10% X7R 2012 R/TP
		C470	0CH3104K566	0.1UF 50V 10% X7R 2012 R/TP
		C471	0CH3104K566	0.1UF 50V 10% X7R 2012 R/TP
		C472	0CH3104K566	0.1UF 50V 10% X7R 2012 R/TP
		C473	0CH3104K566	0.1UF 50V 10% X7R 2012 R/TP
		C474	0CH3104K566	0.1UF 50V 10% X7R 2012 R/TP
		C475	0CH3104K566	0.1UF 50V 10% X7R 2012 R/TP
		C476	0CH3104K566	0.1UF 50V 10% X7R 2012 R/TP
		C477	0CH3104K566	0.1UF 50V 10% X7R 2012 R/TP
		C478	0CH3104K566	0.1UF 50V 10% X7R 2012 R/TP
		C479	0CH3104K566	0.1UF 50V 10% X7R 2012 R/TP
		C480	0CH3104K566	0.1UF 50V 10% X7R 2012 R/TP
		C481	0CH3104K566	0.1UF 50V 10% X7R 2012 R/TP
		C482	0CH3104K566	0.1UF 50V 10% X7R 2012 R/TP
		C483	0CH3104K566	0.1UF 50V 10% X7R 2012 R/TP
		C484	0CH3104K566	0.1UF 50V 10% X7R 2012 R/TP
		C487	0CH3104K566	0.1UF 50V 10% X7R 2012 R/TP
		C488	0CH3104K566	0.1UF 50V 10% X7R 2012 R/TP
		C489	0CH3104K566	0.1UF 50V 10% X7R 2012 R/TP
		C490	0CH3104K566	0.1UF 50V 10% X7R 2012 R/TP
		C491	0CH3104K566	0.1UF 50V 10% X7R 2012 R/TP
		C492	0CH3104K566	0.1UF 50V 10% X7R 2012 R/TP
		C493	0CH3104K566	0.1UF 50V 10% X7R 2012 R/TP
		C494	0CH3104K566	0.1UF 50V 10% X7R 2012 R/TP
		C495	0CH3104K566	0.1UF 50V 10% X7R 2012 R/TP
		C496	0CH3104K566	0.1UF 50V 10% X7R 2012 R/TP
		C497	0CH3104K566	0.1UF 50V 10% X7R 2012 R/TP
		C498	0CH3104K566	0.1UF 50V 10% X7R 2012 R/TP
		C499	0CH3104K566	0.1UF 50V 10% X7R 2012 R/TP
		C501	0CK224CF56A	0.22UF 1608 16V 10% R/TP X7R
		C5012	0CK474CH94A	"0.47UF 1608 25V 80%,-20% R/T"
		C5013	0CK474CH94A	"0.47UF 1608 25V 80%,-20% R/T"
		C5014	0CK474CH94A	"0.47UF 1608 25V 80%,-20% R/T"

DATE: 2005. 05. 19.				
*S	*AL	LOC. NO.	PART NO.	DESCRIPTION / SPECIFICATION
		C5015	0CH8106F69I	10UF 16V 20% 105STD (CYL) R/
		C5019	0CH8106F69I	10UF 16V 20% 105STD (CYL) R/
		C502	0CK224CF56A	0.22UF 1608 16V 10% R/TP X7R
		C5020	0CK103CK51A	0.01UF 1608 50V 10% R/TP B(Y
		C5022	0CK474CH94A	"0.47UF 1608 25V 80%,-20% R/T"
		C503	0CC102CK41A	1000PF 1608 50V 5% R/TP NP0
		C504	0CC102CK41A	1000PF 1608 50V 5% R/TP NP0
		C505	0CE227VF6DC	220UF MV 16V 20% R/TP(SMD) S
		C506	0CK224CF56A	0.22UF 1608 16V 10% R/TP X7R
		C507	0CH3104K566	0.1UF 50V 10% X7R 2012 R/TP
		C508	0CK224CF56A	0.22UF 1608 16V 10% R/TP X7R
		C509	0CK104CK56A	0.1UF 1608 50V 10% R/TP X7R
		C510	0CK104CK56A	0.1UF 1608 50V 10% R/TP X7R
		C511	0CK104CK56A	0.1UF 1608 50V 10% R/TP X7R
		C512	0CK104CK56A	0.1UF 1608 50V 10% R/TP X7R
		C513	0CK224CF56A	0.22UF 1608 16V 10% R/TP X7R
		C514	0CK224CF56A	0.22UF 1608 16V 10% R/TP X7R
		C515	0CK224CF56A	0.22UF 1608 16V 10% R/TP X7R
		C519	0CK224CF56A	0.22UF 1608 16V 10% R/TP X7R
		C524	0CH8106F69I	10UF 16V 20% 105STD (CYL) R/
		C525	0CH8106F69I	10UF 16V 20% 105STD (CYL) R/
		C526	0CH8106F69I	10UF 16V 20% 105STD (CYL) R/
		C527	0CE476WF6DC	47UF MVK 16V 20% R/TP(SMD) S
		C528	0CE475VK6DC	4.7UF MV 50V 20% R/TP(SMD) S
		C529	0CK103CK51A	0.01UF 1608 50V 10% R/TP B(Y
		C530	0CH3104K566	0.1UF 50V 10% X7R 2012 R/TP
		C531	0CH3104K566	0.1UF 50V 10% X7R 2012 R/TP
		C532	0CH3104K566	0.1UF 50V 10% X7R 2012 R/TP
		C533	0CK104CK56A	0.1UF 1608 50V 10% R/TP X7R
		C534	0CH8476K611	47UF 50V 20% 85STD (CYL) R/T
		C535	0CK103CK51A	0.01UF 1608 50V 10% R/TP B(Y
		C536	0CE107WF6DC	100UF MVK 16V 20% R/TP(SMD)
		C537	0CH3104K566	0.1UF 50V 10% X7R 2012 R/TP
		C538	0CH8476K611	47UF 50V 20% 85STD (CYL) R/T
		C539	0CC102CK41A	1000PF 1608 50V 5% R/TP NP0
		C540	0CC102CK41A	1000PF 1608 50V 5% R/TP NP0
		C541	0CC101CK41A	100PF 1608 50V 5% R/TP NP0
		C542	0CK474CH94A	"0.47UF 1608 25V 80%,-20% R/T"
		C543	0CK104CK56A	0.1UF 1608 50V 10% R/TP X7R
		C544	0CC560CK41A	56PF 1608 50V 5% R/TP NP0
		C545	0CK104CK56A	0.1UF 1608 50V 10% R/TP X7R
		C546	0CH6560K416	56PF 50V J NP0 2012 R/TP
		C547	0CH3105H946	"1UF 25V 80%,-20% F(Y5V) 2012"
		C548	0CH6560K416	56PF 50V J NP0 2012 R/TP
		C549	0CK474CH94A	"0.47UF 1608 25V 80%,-20% R/T"
		C550	0CK105CF94A	"1UF 1608 16V 80%,-20% R/TP F"
		C551	0CK474CH94A	"0.47UF 1608 25V 80%,-20% R/T"
		C552	0CC3R3CK01A	3.3PF 1608 50V 0.25 PF R/TP
		C553	0CK105CF94A	"1UF 1608 16V 80%,-20% R/TP F"
		C554	0CK105CF94A	"1UF 1608 16V 80%,-20% R/TP F"
		C555	0CK105CF94A	"1UF 1608 16V 80%,-20% R/TP F"
		C556	0CK105CF94A	"1UF 1608 16V 80%,-20% R/TP F"
		C557	0CK152CK51A	1500PF 1608 50V 10% R/TP B(Y
		C558	0CK474CH94A	"0.47UF 1608 25V 80%,-20% R/T"
		C559	0CK104CK56A	0.1UF 1608 50V 10% R/TP X7R
		C560	0CK152CK51A	1500PF 1608 50V 10% R/TP B(Y
		C561	0CC221CK41A	220PF 1608 50V 5% R/TP NP0
		C562	0CC3R3CK01A	3.3PF 1608 50V 0.25 PF R/TP
		C563	0CH3105H946	"1UF 25V 80%,-20% F(Y5V) 2012"
		C564	0CH8476K611	47UF 50V 20% 85STD (CYL) R/T
		C565	0CK104CK56A	0.1UF 1608 50V 10% R/TP X7R
		C566	0CK104CK56A	0.1UF 1608 50V 10% R/TP X7R

DATE: 2005. 05. 19.				
*S	*AL	LOC. NO.	PART NO.	DESCRIPTION / SPECIFICATION
			C567	0CK474CH94A "0.47UF 1608 25V 80%,-20% R/T"
			C568	0CK103CK51A 0.01UF 1608 50V 10% R/TP B(Y)
			C569	0CC102CK41A 1000PF 1608 50V 5% R/TP NP0
			C570	0CK474CH94A "0.47UF 1608 25V 80%,-20% R/T"
			C571	0CK474CH94A "0.47UF 1608 25V 80%,-20% R/T"
			C572	0CK103CK51A 0.01UF 1608 50V 10% R/TP B(Y)
			C573	0CC102CK41A 1000PF 1608 50V 5% R/TP NP0
			C574	0CK332CK51A 3300PF 1608 50V 10% R/TP B(Y)
			C575	0CK332CK51A 3300PF 1608 50V 10% R/TP B(Y)
			C576	0CK474CH94A "0.47UF 1608 25V 80%,-20% R/T"
			C577	0CE107WF6DC 100UF MVK 16V 20% R/TP(SMD)
			C578	0CH3103K516 10000PF 50V 10% B(Y5P) 2012
			C579	0CK104CK56A 0.1UF 1608 50V 10% R/TP X7R
			C580	0CK104CK56A 0.1UF 1608 50V 10% R/TP X7R
			C581	0CE107WF6DC 100UF MVK 16V 20% R/TP(SMD)
			C582	0CH3104K566 0.1UF 50V 10% X7R 2012 R/TP
			C603	0CE227WJ6DC 220UF MVK/RC 35V 20% SMD TAP
			C604	0CH3105H946 "1UF 25V 80%,-20% F(Y5V) 2012"
			C605	0CC102CK41A 1000PF 1608 50V 5% R/TP NP0
			C606	0CH3103K516 10000PF 50V 10% B(Y5P) 2012
			C607	0CK104CK56A 0.1UF 1608 50V 10% R/TP X7R
			C608	0CH8476K611 47UF 50V 20% 85STD (CYL) R/T
			C609	0CK104CK56A 0.1UF 1608 50V 10% R/TP X7R
			C610	0CK104CK56A 0.1UF 1608 50V 10% R/TP X7R
			C611	0CK103CK51A 0.01UF 1608 50V 10% R/TP B(Y)
			C612	0CE477EF638 470UF KMG 16V M FM5 TP 5
			C614	0CH3103K516 10000PF 50V 10% B(Y5P) 2012
			C615	0CK105CF94A "1UF 1608 16V 80%,-20% R/TP F"
			C616	0CE227VF6DC 220UF MV 16V 20% R/TP(SMD) S
			C617	0CK104CK56A 0.1UF 1608 50V 10% R/TP X7R
			C618	0CC102CK41A 1000PF 1608 50V 5% R/TP NP0
			C619	0CE477EF638 470UF KMG 16V M FM5 TP 5
			C620	0CH3103K516 10000PF 50V 10% B(Y5P) 2012
			C621	0CK104CK56A 0.1UF 1608 50V 10% R/TP X7R
			C622	0CK103CK51A 0.01UF 1608 50V 10% R/TP B(Y)
			C623	0CE477EF638 470UF KMG 16V M FM5 TP 5
			C624	0CH8226F691 22UF 16V 20% 105STD (CYL) R/
			C625	0CH3104K566 0.1UF 50V 10% X7R 2012 R/TP
			C627	0CH8476K611 47UF 50V 20% 85STD (CYL) R/T
			C628	0CH8476K611 47UF 50V 20% 85STD (CYL) R/T
			C629	0CH3103K516 10000PF 50V 10% B(Y5P) 2012
			C630	0CH3103K516 10000PF 50V 10% B(Y5P) 2012
			C632	0CE227VF6DC 220UF MV 16V 20% R/TP(SMD) S
			C633	0CH3104K566 0.1UF 50V 10% X7R 2012 R/TP
			C636	0CC102CK41A 1000PF 1608 50V 5% R/TP NP0
			C637	0CE227VF6DC 220UF MV 16V 20% R/TP(SMD) S
			C638	0CE227VF6DC 220UF MV 16V 20% R/TP(SMD) S
			C639	0CK104CK56A 0.1UF 1608 50V 10% R/TP X7R
			C640	0CH3104K566 0.1UF 50V 10% X7R 2012 R/TP
			C642	0CE107WF6DC 100UF MVK 16V 20% R/TP(SMD)
			C643	0CK104CK56A 0.1UF 1608 50V 10% R/TP X7R
			C645	0CH3104K566 0.1UF 50V 10% X7R 2012 R/TP
			C646	0CH8226F691 22UF 16V 20% 105STD (CYL) R/
			C648	0CH3104K566 0.1UF 50V 10% X7R 2012 R/TP
			C650	0CH3104K566 0.1UF 50V 10% X7R 2012 R/TP
			C651	0CE227VF6DC 220UF MV 16V 20% R/TP(SMD) S
			C652	0CE107WF6DC 100UF MVK 16V 20% R/TP(SMD)
			C654	0CK104CK56A 0.1UF 1608 50V 10% R/TP X7R
			C655	0CH3104K566 0.1UF 50V 10% X7R 2012 R/TP
			C659	0CE227VF6DC 220UF MV 16V 20% R/TP(SMD) S
			C664	0CK104CK56A 0.1UF 1608 50V 10% R/TP X7R
			C666	0CH8226F691 22UF 16V 20% 105STD (CYL) R/

DATE: 2005. 05. 19.				
*S	*AL	LOC. NO.	PART NO.	DESCRIPTION / SPECIFICATION
			C667	0CH8226F691 22UF 16V 20% 105STD (CYL) R/
			C669	0CH3104K566 0.1UF 50V 10% X7R 2012 R/TP
			C671	0CE107WF6DC 100UF MVK 16V 20% R/TP(SMD)
			C672	0CE227VF6DC 220UF MV 16V 20% R/TP(SMD) S
			C673	0CH3104K566 0.1UF 50V 10% X7R 2012 R/TP
			C677	0CH3103K516 10000PF 50V 10% B(Y5P) 2012
			C678	0CH8106F691 10UF 16V 20% 105STD (CYL) R/
			C679	0CH3103K516 10000PF 50V 10% B(Y5P) 2012
			C680	0CE477EF638 470UF KMG 16V M FM5 TP 5
			C681	0CE477EF638 470UF KMG 16V M FM5 TP 5
			C682	0CH3104K566 0.1UF 50V 10% X7R 2012 R/TP
			C702	0CC471CK41A 470PF 1608 50V 5% R/TP NP0
			C704	0CC471CK41A 470PF 1608 50V 5% R/TP NP0
			C706	0CC471CK41A 470PF 1608 50V 5% R/TP NP0
			C708	0CC471CK41A 470PF 1608 50V 5% R/TP NP0
			C713	0CC471CK41A 470PF 1608 50V 5% R/TP NP0
			C714	0CC471CK41A 470PF 1608 50V 5% R/TP NP0
			C720	0CC331CK41A 330PF 1608 50V 5% R/TP NP0
			C725	0CH6101K416 100PF 50V J NP0 2012 R/TP
			C726	0CH6471K416 470F 50V J NP0 2012 R/TP
			C727	0CH6101K416 100PF 50V J NP0 2012 R/TP
			C728	0CH6471K416 470F 50V J NP0 2012 R/TP
			C730	0CC471CK41A 470PF 1608 50V 5% R/TP NP0
			C732	0CC471CK41A 470PF 1608 50V 5% R/TP NP0
			C733	0CE107WF6DC 100UF MVK 16V 20% R/TP(SMD)
			C734	0CE107WF6DC 100UF MVK 16V 20% R/TP(SMD)
			C735	0CE227VF6DC 220UF MV 16V 20% R/TP(SMD) S
			C835	0CE107WF6DC 100UF MVK 16V 20% R/TP(SMD)
			C836	0CK104CK56A 0.1UF 1608 50V 10% R/TP X7R
			C9001	0CK473CK56A 47000PF 1608 50V 10% R/TP X7
			C9002	0CH3104K566 0.1UF 50V 10% X7R 2012 R/TP
			C9003	0CH3104K566 0.1UF 50V 10% X7R 2012 R/TP
			C9004	0CH3104K566 0.1UF 50V 10% X7R 2012 R/TP
			C9005	0CH3104K566 0.1UF 50V 10% X7R 2012 R/TP
			C9006	0CH3104K566 0.1UF 50V 10% X7R 2012 R/TP
			C9007	0CH3104K566 0.1UF 50V 10% X7R 2012 R/TP
			C901	0CC3R3CK01A 3.3PF 1608 50V 0.25 PF R/TP
			C9010	0CK104CK56A 0.1UF 1608 50V 10% R/TP X7R
			C9011	0CK104CK56A 0.1UF 1608 50V 10% R/TP X7R
			C9012	0CC821CK41A 820PF 1608 50V 5% R/TP NP0
			C9013	0CK106EF566 10UF 3216 16V 10% X7R R/TP
			C9014	0CH3104K566 0.1UF 50V 10% X7R 2012 R/TP
			C9015	0CH3104K566 0.1UF 50V 10% X7R 2012 R/TP
			C9016	0CE335VK6DC 3.3UF MV 50V 20% R/TP(SMD) S
			C9017	0CE335VK6DC 3.3UF MV 50V 20% R/TP(SMD) S
			C9018	0CE335VK6DC 3.3UF MV 50V 20% R/TP(SMD) S
			C9019	0CE335VK6DC 3.3UF MV 50V 20% R/TP(SMD) S
			C902	0CC3R3CK01A 3.3PF 1608 50V 0.25 PF R/TP
			C9020	0CE335VK6DC 3.3UF MV 50V 20% R/TP(SMD) S
			C903	0CE227VF6DC 220UF MV 16V 20% R/TP(SMD) S
			C904	0CH8226F691 22UF 16V 20% 105STD (CYL) R/
			C905	0CK104CK56A 0.1UF 1608 50V 10% R/TP X7R
			C906	0CK104CK56A 0.1UF 1608 50V 10% R/TP X7R
			C907	0CH3104K566 0.1UF 50V 10% X7R 2012 R/TP
			C908	0CH3104K566 0.1UF 50V 10% X7R 2012 R/TP
			C909	0CK104CK56A 0.1UF 1608 50V 10% R/TP X7R
			C910	0CH3104K566 0.1UF 50V 10% X7R 2012 R/TP
			C911	0CH3104K566 0.1UF 50V 10% X7R 2012 R/TP
			C912	0CK104CK56A 0.1UF 1608 50V 10% R/TP X7R
			C913	0CH3104K566 0.1UF 50V 10% X7R 2012 R/TP
			C914	0CE227VF6DC 220UF MV 16V 20% R/TP(SMD) S
			C915	0CE227VF6DC 220UF MV 16V 20% R/TP(SMD) S

DATE: 2005. 05. 19.				
*S	*AL	LOC. NO.	PART NO.	DESCRIPTION / SPECIFICATION
		C916	0CH8226F691	22UF 16V 20% 105STD (CYL) R/
		C917	0CH3104K566	0.1UF 50V 10% X7R 2012 R/TP
		C918	0CK104CK56A	0.1UF 1608 50V 10% R/TP X7R
		C919	0CH3104K566	0.1UF 50V 10% X7R 2012 R/TP
		C920	0CH3104K566	0.1UF 50V 10% X7R 2012 R/TP
		C921	0CK104CK56A	0.1UF 1608 50V 10% R/TP X7R
		C922	0CK104CK56A	0.1UF 50V 10% X7R 2012 R/TP
		C923	0CH3104K566	0.1UF 50V 10% X7R 2012 R/TP
		C924	0CH3104K566	0.1UF 50V 10% X7R 2012 R/TP
		C925	0CH8226F691	22UF 16V 20% 105STD (CYL) R/
		C926	0CK104CK56A	0.1UF 1608 50V 10% R/TP X7R
		C927	0CH3104K566	0.1UF 50V 10% X7R 2012 R/TP
		C928	0CH3104K566	0.1UF 50V 10% X7R 2012 R/TP
		C929	0CH3104K566	0.1UF 50V 10% X7R 2012 R/TP
		C930	0CH3104K566	0.1UF 50V 10% X7R 2012 R/TP
		C931	0CH8226F691	22UF 16V 20% 105STD (CYL) R/
		C932	0CH3104K566	0.1UF 50V 10% X7R 2012 R/TP
		C933	0CH3104K566	0.1UF 50V 10% X7R 2012 R/TP
		C934	0CK104CK56A	0.1UF 1608 50V 10% R/TP X7R
		C935	0CK104CK56A	0.1UF 1608 50V 10% R/TP X7R
		C936	0CH8226F691	22UF 16V 20% 105STD (CYL) R/
		C937	0CK104CK56A	0.1UF 1608 50V 10% R/TP X7R
		C938	0CK104CK56A	0.1UF 1608 50V 10% R/TP X7R
		C939	0CK104CK56A	0.1UF 1608 50V 10% R/TP X7R
		C940	0CH3104K566	0.1UF 50V 10% X7R 2012 R/TP
		C941	0CH3104K566	0.1UF 50V 10% X7R 2012 R/TP
		C942	0CH3104K566	0.1UF 50V 10% X7R 2012 R/TP
		C943	0CH3104K566	0.1UF 50V 10% X7R 2012 R/TP
		C944	0CH3104K566	0.1UF 50V 10% X7R 2012 R/TP
		C945	0CH3104K566	0.1UF 50V 10% X7R 2012 R/TP
		C946	0CK104CK56A	0.1UF 1608 50V 10% R/TP X7R
		C948	0CC821CK41A	820PF 1608 50V 5% R/TP NP0
		C949	0CH3104K566	0.1UF 50V 10% X7R 2012 R/TP
		C950	0CH3104K566	0.1UF 50V 10% X7R 2012 R/TP
		C951	0CH3104K566	0.1UF 50V 10% X7R 2012 R/TP
		C952	0CK104CK56A	0.1UF 1608 50V 10% R/TP X7R
		C953	0CE107WF6DC	100UF MVK 16V 20% R/TP(SMD)
		C954	0CH3104K566	0.1UF 50V 10% X7R 2012 R/TP
		C955	0CK104CK56A	0.1UF 1608 50V 10% R/TP X7R
		C956	0CH3104K566	0.1UF 50V 10% X7R 2012 R/TP
		C957	0CH3104K566	0.1UF 50V 10% X7R 2012 R/TP
		C958	0CH3104K566	0.1UF 50V 10% X7R 2012 R/TP
		C961	0CH3104K566	0.1UF 50V 10% X7R 2012 R/TP
		C962	0CH3104K566	0.1UF 50V 10% X7R 2012 R/TP
		C963	0CK104CK56A	0.1UF 1608 50V 10% R/TP X7R
		C964	0CK104CK56A	0.1UF 1608 50V 10% R/TP X7R
		C965	0CC270CK41A	27PF 1608 50V 5% R/TP NP0
		C966	0CC270CK41A	27PF 1608 50V 5% R/TP NP0
		C967	0CE227VF6DC	220UF MV 16V 20% R/TP(SMD) S
		C968	0CH8105K691	1UF 50V 20% 105STD (CYL) R/T
		C969	0CH3104K566	0.1UF 50V 10% X7R 2012 R/TP
		C970	0CH3104K566	0.1UF 50V 10% X7R 2012 R/TP
		C971	0CH3104K566	0.1UF 50V 10% X7R 2012 R/TP
		C972	0CH3104K566	0.1UF 50V 10% X7R 2012 R/TP
		C973	0CH3104K566	0.1UF 50V 10% X7R 2012 R/TP
		C974	0CK104CK56A	0.1UF 1608 50V 10% R/TP X7R
		C975	0CH3104K566	0.1UF 50V 10% X7R 2012 R/TP
		C977	0CK104CK56A	0.1UF 1608 50V 10% R/TP X7R
		C978	0CH8226F691	22UF 16V 20% 105STD (CYL) R/
		C979	0CK104CK56A	0.1UF 1608 50V 10% R/TP X7R
		C980	0CH3104K566	0.1UF 50V 10% X7R 2012 R/TP
		C981	0CH3104K566	0.1UF 50V 10% X7R 2012 R/TP

DATE: 2005. 05. 19.				
*S	*AL	LOC. NO.	PART NO.	DESCRIPTION / SPECIFICATION
		C982	0CE337WF6DC	330UF MVK 16V 20% R/TP(SMD)
		C983	0CH3104K566	0.1UF 50V 10% X7R 2012 R/TP
		C984	0CH3104K566	0.1UF 50V 10% X7R 2012 R/TP
		C985	0CK104CK56A	0.1UF 1608 50V 10% R/TP X7R
		C986	0CH3104K566	0.1UF 50V 10% X7R 2012 R/TP
		C987	0CH3104K566	0.1UF 50V 10% X7R 2012 R/TP
		C988	0CH3104K566	0.1UF 50V 10% X7R 2012 R/TP
		C989	0CH3104K566	0.1UF 50V 10% X7R 2012 R/TP
		C990	0CH3104K566	0.1UF 50V 10% X7R 2012 R/TP
		C991	0CH3104K566	0.1UF 50V 10% X7R 2012 R/TP
		C992	0CH3104K566	0.1UF 50V 10% X7R 2012 R/TP
		C993	0CH3104K566	0.1UF 50V 10% X7R 2012 R/TP
		C994	0CH3104K566	0.1UF 50V 10% X7R 2012 R/TP
		C995	0CC221CK41A	220PF 1608 50V 5% R/TP NP0
		C996	0CC331CK41A	330PF 1608 50V 5% R/TP NP0
		C997	0CK473CK56A	47000PF 1608 50V 10% R/TP X7
		C998	0CC101CK41A	100PF 1608 50V 5% R/TP NP0
		C999	0CC151CK41A	150PF 1608 50V 5% NP0 R/TP
DIODEs				
		D101	0DS226009AA	KDS226 TP KEC - 80V -- 4NSE
		D102	0DS226009AA	KDS226 TP KEC - 80V -- 4NSE
		D103	0DS226009AA	KDS226 TP KEC - 80V -- 4NSE
		D104	0DS226009AA	KDS226 TP KEC - 80V -- 4NSE
		D105	0DS226009AA	KDS226 TP KEC - 80V -- 4NSE
		D106	0DSON00138A	"MMBD301LT1G,LF ON SEMI R/TP"
		D107	0DSON00138A	"MMBD301LT1G,LF ON SEMI R/TP"
		D108	0DSON00138A	"MMBD301LT1G,LF ON SEMI R/TP"
		D109	0DSON00138A	"MMBD301LT1G,LF ON SEMI R/TP"
		D505	0DSON00138A	"MMBD301LT1G,LF ON SEMI R/TP"
		D506	0DSON00138A	"MMBD301LT1G,LF ON SEMI R/TP"
		D507	0DSON00138A	"MMBD301LT1G,LF ON SEMI R/TP"
		D508	0DSON00138A	"MMBD301LT1G,LF ON SEMI R/TP"
		D601	0DS226009AA	KDS226 TP KEC - 80V -- 4NSE
		D603	0DS226009AA	KDS226 TP KEC - 80V -- 4NSE
		D604	0DS226009AA	KDS226 TP KEC - 80V -- 4NSE
		U102	0DRCE00018A	"PACDN004SR,LF CAMD R/TP SOT1"
		U103	0DRCE00018A	"PACDN004SR,LF CAMD R/TP SOT1"
		U105	0DRCE00018A	"PACDN004SR,LF CAMD R/TP SOT1"
		U106	0DRCE00018A	"PACDN004SR,LF CAMD R/TP SOT1"
		U108	0DRCE00018A	"PACDN004SR,LF CAMD R/TP SOT1"
		U109	0DRCE00018A	"PACDN004SR,LF CAMD R/TP SOT1"
		U110	0DRCE00018A	"PACDN004SR,LF CAMD R/TP SOT1"
		U111	0DRCE00018A	"PACDN004SR,LF CAMD R/TP SOT1"
		ZD101	0DZ560009DA	UDZ S 5.6B TP ROHM-K SOD323
		ZD102	0DZ560009DA	UDZ S 5.6B TP ROHM-K SOD323
		ZD103	0DZ560009DA	UDZ S 5.6B TP ROHM-K SOD323
		ZD104	0DZ560009DA	UDZ S 5.6B TP ROHM-K SOD323
		ZD105	0DZ560009DA	UDZ S 5.6B TP ROHM-K SOD323
		ZD106	0DZ560009DA	UDZ S 5.6B TP ROHM-K SOD323
		ZD107	0DZ560009DA	UDZ S 5.6B TP ROHM-K SOD323
		ZD108	0DZ560009DA	UDZ S 5.6B TP ROHM-K SOD323
		ZD401	0DZ910009FE	UDZS 9.1B TP ROHM -- 9.1V -
		ZD402	0DZ910009FE	UDZS 9.1B TP ROHM -- 9.1V -
		ZD403	0DZ910009FE	UDZS 9.1B TP ROHM -- 9.1V -
		ZD501	0DZ560009DA	UDZ S 5.6B TP ROHM-K SOD323
		ZD502	0DZ560009DA	UDZ S 5.6B TP ROHM-K SOD323
		ZD503	0DZ560009DA	UDZ S 5.6B TP ROHM-K SOD323
		ZD504	0DZ560009DA	UDZ S 5.6B TP ROHM-K SOD323
		ZD505	0DZ560009DA	UDZ S 5.6B TP ROHM-K SOD323
		ZD601	0DZ560009DA	UDZ S 5.6B TP ROHM-K SOD323

DATE: 2005. 05. 19.				
*S	*AL	LOC. NO.	PART NO.	DESCRIPTION / SPECIFICATION
		ZD602	0DZ330009DF	MTZJ33B TP ROHM-K DO34 0.5W
		ZD701	0DZ560009DA	UDZ S 5.6B TP ROHM-K SOD323
		ZD704	0DZ560009DA	UDZ S 5.6B TP ROHM-K SOD323
		ZD705	0DZ560009DA	UDZ S 5.6B TP ROHM-K SOD323
		ZD706	0DZ560009DA	UDZ S 5.6B TP ROHM-K SOD323
		ZD707	0DZ560009DA	UDZ S 5.6B TP ROHM-K SOD323
		ZD708	0DZ560009DA	UDZ S 5.6B TP ROHM-K SOD323
		ZD709	0DZ560009DA	UDZ S 5.6B TP ROHM-K SOD323
		ZD710	0DZ560009DA	UDZ S 5.6B TP ROHM-K SOD323
		ZD711	0DZ560009DA	UDZ S 5.6B TP ROHM-K SOD323
		ZD712	0DZ560009DA	UDZ S 5.6B TP ROHM-K SOD323
		ZD713	0DZ560009DA	UDZ S 5.6B TP ROHM-K SOD323
		ZD714	0DZ560009DA	UDZ S 5.6B TP ROHM-K SOD323
		ZD715	0DZ560009DA	UDZ S 5.6B TP ROHM-K SOD323
		ZD716	0DZ560009DA	UDZ S 5.6B TP ROHM-K SOD323
		ZD719	0DZ560009DA	UDZ S 5.6B TP ROHM-K SOD323
		ZD720	0DZ560009DA	UDZ S 5.6B TP ROHM-K SOD323
		ZD721	0DZ560009DA	UDZ S 5.6B TP ROHM-K SOD323
		ZD722	0DZ560009DA	UDZ S 5.6B TP ROHM-K SOD323
		ZD723	0DZ560009DA	UDZ S 5.6B TP ROHM-K SOD323
		ZD724	0DZ560009DA	UDZ S 5.6B TP ROHM-K SOD323
ICs				
		Q404	0IKE704200J	KIA7042AF SOT-89 TP 4.2V VOL
		Q506	0IKE704200J	KIA7042AF SOT-89 TP 4.2V VOL
		U1003	0IFA754207A	"KA75420ZTA(KA7542ZTA) 3P,TO-"
		U1004	0ISTLFA094A	"FSTD3306MTC FAIRCHILD 8P,TSS"
		U1012	0IPRPAJ001A	"EX128-FTQ100PJ85,NTSC ACTEL"
		U114	0ISS524202B	"S524A40X21-SCT0, LF SAMSUNG"
		U115	0ISS524202B	"S524A40X21-SCT0, LF SAMSUNG"
		U201	0ISO204000A	"CXA2040AQ 32P,QFP BK IIC BUS"
		U203	0ISS780500H	"KA78M05-R 3P,D-PAK TP 5V 0.5"
		U204	0IPMGKE036A	KIA78DL09F KEC DPARK R/TP 9V
		U303	0IPRPM3002B	"MST9883C-110 MSTAR 80P,LQFP"
		U401	0IMMRHY051A	"HY5DU283222AQ-4 HYNIX 100P,L"
		U402	0IPRPGN011D	GM1501H-CF(HDCP)BRAND GENESI
		U403	0IZZTSZ707A	L3700AC AV 48P AV ONLY
		U404	0IMMRSS040C	"S524A60X51-SC70,LF SAMSUNG E"
		U407	0ISTLFA058A	"74F14SCX FAIRCHILD 14P,SOIC"
		U501	0IPRPMN001C	MSP3420G-C12-100 MICRONAS 80
		U502	0IPRPTI036A	TPA3004D2PHPR TEXAS INSTRUME
		U503	0IPRPJR017A	"NJU26901E2 JRC 8P,EMP R/TP D"
		U504	0IPMGFA003B	RC1117S-2.5 FAIRCHILD SOT-22
		U505	0IMX232162A	MAX232ACSE 16NARROW-SO RS232
		U506	0ISTLFA092B	74VHC157MX_NL FAIRCHILD 16PI
		U522	0ISS780800J	"KA78M08R 3P,D-PAK TP VOL. RE"
		U609	0IPMGSG020A	"LD1117DT18TR,LF SGS-THOMSON"
		U612	0IPMGFA003B	RC1117S-2.5 FAIRCHILD SOT-22
		U614	0IPMGNS001E	"LM1117MPX-3.3,NOPB NATIONAL"
		U616	0IPMGNS001E	"LM1117MPX-3.3,NOPB NATIONAL"
		U621	0IPMGNS001E	"LM1117MPX-3.3,NOPB NATIONAL"
		U901	0IPRPM7001A	"MDIN-150 MIT 256PIN,QFP TRAY"
		U902	0IMMRSS037E	K4S643232H-TC60 SAMSUNG ELEC
		U903	0IMMR0K005A	"MSM56V16160F-7 OKI TSSOP,50P"
		U904	0IPRPN008A	"UPD64011BGM-8ED-A NEC 160,LQ"
		U905	0IPMGNS001E	"LM1117MPX-3.3,NOPB NATIONAL"
		U906	0IPMGRH001D	"BA15BC0FP-E2 ROHM 3P,TO252 R"
		U907	0IPMGNS001E	"LM1117MPX-3.3,NOPB NATIONAL"
		U908	0IPMGFA003B	RC1117S-2.5 FAIRCHILD SOT-22
COILs & COREs & FILTERs				
		L511	6140TBZ007E	"SLF12575T-330M3R2,TDK SMD CH"

DATE: 2005. 05. 19.				
*S	*AL	LOC. NO.	PART NO.	DESCRIPTION / SPECIFICATION
		L512	6140TBZ007E	"SLF12575T-330M3R2,TDK SMD CH"
		L513	6140TBZ007E	"SLF12575T-330M3R2,TDK SMD CH"
		L514	6140TBZ007E	"SLF12575T-330M3R2,TDK SMD CH"
		L22	6210TCE001P	HB-1S2012-121JT CERATECH 201
		L23	6210TCE001P	HB-1S2012-121JT CERATECH 201
		L401	6210TCE001H	HB-1T2012-301JT CERATEC 2012
		L402	6210TCE001H	HB-1T2012-301JT CERATEC 2012
		L403	6210TCE001H	HB-1T2012-301JT CERATEC 2012
		L404	6210TCE001H	HB-1T2012-301JT CERATEC 2012
		L405	6210TCE001H	HB-1T2012-301JT CERATEC 2012
		L406	6210TCE001H	HB-1T2012-301JT CERATEC 2012
		L407	6210TCE001H	HB-1T2012-301JT CERATEC 2012
		L408	6210TCE001H	HB-1T2012-301JT CERATEC 2012
		L611	6210TCE001H	HB-1T2012-301JT CERATEC 2012
		L613	6210TCE001H	HB-1T2012-301JT CERATEC 2012
		L701	6210TCE001P	HB-1S2012-121JT CERATECH 201
		L702	6210TCE001P	HB-1S2012-121JT CERATECH 201
		L704	6210TCE001P	HB-1S2012-121JT CERATECH 201
		L705	6210TCE001P	HB-1S2012-121JT CERATECH 201
		L706	6210TCE001P	HB-1S2012-121JT CERATECH 201
		L707	6210TCE001P	HB-1S2012-121JT CERATECH 201
		L710	6210TCE001F	HB-1S2012-800JT CERATEC 2012
		L711	6210TCE001F	HB-1S2012-800JT CERATEC 2012
		L712	6210TCE001H	HB-1T2012-301JT CERATEC 2012
		L713	6210TCE001H	HB-1T2012-301JT CERATEC 2012
		L920	6210TCE001P	HB-1S2012-121JT CERATECH 201
		L1001	6210TCE001G	HH-1M3216-501 CERATEC 3216MM
		L1002	6210TCE001G	HH-1M3216-501 CERATEC 3216MM
		L101	6210TCE001A	HB-1S2012-080JT CERATEC 2012
		L1010	6210TCE001S	HU-1M2012-121 CERATECH 2012M
		L1011	6210TCE001S	HU-1M2012-121 CERATECH 2012M
		L103	6210TCE001Y	HB-1H2012-320JT CERATEC 2012
		L104	6210TCE001Y	HB-1H2012-320JT CERATEC 2012
		L107	6210TCE001Y	HB-1H2012-320JT CERATEC 2012
		L201	6210TCE001G	HH-1M3216-501 CERATEC 3216MM
		L202	6210TCE001S	HU-1M2012-121 CERATECH 2012M
		L203	6200J00011A	H354LAI-K5202 TOKO R/TP BAND
		L213	6210TCE001G	HH-1M3216-501 CERATEC 3216MM
		L215	6210TCE001S	HU-1M2012-121 CERATECH 2012M
		L216	6210TCE001S	HU-1M2012-121 CERATECH 2012M
		L217	6200J00011A	H354LAI-K5202 TOKO R/TP BAND
		L218	6200J00011A	H354LAI-K5202 TOKO R/TP BAND
		L219	6210TCE001G	HH-1M3216-501 CERATEC 3216MM
		L220	6210TCE001G	HH-1M3216-501 CERATEC 3216MM
		L221	6210TCE001G	HH-1M3216-501 CERATEC 3216MM
		L222	6210TCE001S	HU-1M2012-121 CERATECH 2012M
		L223	6210TCE001S	HU-1M2012-121 CERATECH 2012M
		L307	6210TCE001S	HU-1M2012-121 CERATECH 2012M
		L308	6210TCE001S	HU-1M2012-121 CERATECH 2012M
		L309	6210TCE001S	HU-1M2012-121 CERATECH 2012M
		L501	6210TCE001G	HH-1M3216-501 CERATEC 3216MM
		L502	6210TCE001G	HH-1M3216-501 CERATEC 3216MM
		L503	6210TCE001G	HH-1M3216-501 CERATEC 3216MM
		L504	6210TCE001G	HH-1M3216-501 CERATEC 3216MM
		L505	6210TCE001G	HH-1M3216-501 CERATEC 3216MM
		L506	6210TCE001S	HU-1M2012-121 CERATECH 2012M
		L507	6210TCE001S	HU-1M2012-121 CERATECH 2012M
		L508	6210TCE001S	HU-1M2012-121 CERATECH 2012M
		L509	6210TCE001S	HU-1M2012-121 CERATECH 2012M
		L510	6210TCE001G	HH-1M3216-501 CERATEC 3216MM
		L601	6210TCE001G	HH-1M3216-501 CERATEC 3216MM
		L602	6210TCE001G	HH-1M3216-501 CERATEC 3216MM

DATE: 2005. 05. 19.				
*S	*AL	LOC. NO.	PART NO.	DESCRIPTION / SPECIFICATION
		L603	6210TCE001G	HH-1M3216-501 CERATEC 3216MM
		L604	6210TCE001G	HH-1M3216-501 CERATEC 3216MM
		L605	6210TCE001G	HH-1M3216-501 CERATEC 3216MM
		L606	6210TCE001G	HH-1M3216-501 CERATEC 3216MM
		L609	6210TCE001G	HH-1M3216-501 CERATEC 3216MM
		L610	6210TCE001G	HH-1M3216-501 CERATEC 3216MM
		L614	6210TCE001G	HH-1M3216-501 CERATEC 3216MM
		L615	6210TCE001G	HH-1M3216-501 CERATEC 3216MM
		L616	6210TCE001G	HH-1M3216-501 CERATEC 3216MM
		L617	6210TCE001G	HH-1M3216-501 CERATEC 3216MM
		L618	6210TCE001G	HH-1M3216-501 CERATEC 3216MM
		L619	6210TCE001G	HH-1M3216-501 CERATEC 3216MM
		L620	6210TCE001G	HH-1M3216-501 CERATEC 3216MM
		L621	6210TCE001G	HH-1M3216-501 CERATEC 3216MM
		L622	6210TCE001G	HH-1M3216-501 CERATEC 3216MM
		L623	6210TCE001G	HH-1M3216-501 CERATEC 3216MM
		L901	6210TCE001G	HH-1M3216-501 CERATEC 3216MM
		L902	6210TCE001G	HH-1M3216-501 CERATEC 3216MM
		L903	6210TCE001G	HH-1M3216-501 CERATEC 3216MM
		L904	6210TCE001G	HH-1M3216-501 CERATEC 3216MM
		L905	6210TCE001G	HH-1M3216-501 CERATEC 3216MM
		L906	6210TCE001S	HU-1M2012-121 CERATECH 2012M
		L907	6210TCE001S	HU-1M2012-121 CERATECH 2012M
		L909	6200J00011A	H354LAI-K5202 TOKO R/TP BAND
		L913	6210TCE001S	HU-1M2012-121 CERATECH 2012M
		L914	6210TCE001G	HH-1M3216-501 CERATEC 3216MM
		L915	6210TCE001G	HH-1M3216-501 CERATEC 3216MM
		L916	6210TCE001G	HH-1M3216-501 CERATEC 3216MM
		L917	6210TCE001G	HH-1M3216-501 CERATEC 3216MM
		L918	6210TCE001G	HH-1M3216-501 CERATEC 3216MM
		L919	6210TCE001S	HU-1M2012-121 CERATECH 2012M
		R905	6210TCE001R	HB-1S2012-400JT CERATECH 201
TRANSISTOR				
		Q201	0TR387500AA	CHIP 2SC3875S(ALY) BK KEC -
		Q202	0TR150400BA	CHIP 2SA1504S(ASY) BK KEC -
		Q203	0TR390409AE	FAIRCHILD KST3904(LGEMTF) TP
		Q204	0TR390409AE	FAIRCHILD KST3904(LGEMTF) TP
		Q206	0TR387500AA	CHIP 2SC3875S(ALY) BK KEC -
		Q209	0TR387500AA	CHIP 2SC3875S(ALY) BK KEC -
		Q210	0TR150400BA	CHIP 2SA1504S(ASY) BK KEC -
		Q211	0TR387500AA	CHIP 2SC3875S(ALY) BK KEC -
		Q212	0TR150400BA	CHIP 2SA1504S(ASY) BK KEC -
		Q401	0TR162309CA	KSC1623 TP SAMSUNG SOT23 NP
		Q402	0TR162309CA	KSC1623 TP SAMSUNG SOT23 NP
		Q403	0TR162309CA	KSC1623 TP SAMSUNG SOT23 NP
		Q405	0TR162309CA	KSC1623 TP SAMSUNG SOT23 NP
		Q406	0TR162309CA	KSC1623 TP SAMSUNG SOT23 NP
		Q407	0TR162309CA	KSC1623 TP SAMSUNG SOT23 NP
		Q501	0TR162309CA	KSC1623 TP SAMSUNG SOT23 NP
		Q502	0TR162309CA	KSC1623 TP SAMSUNG SOT23 NP
		Q503	0TR162309CA	KSC1623 TP SAMSUNG SOT23 NP
		Q504	0TR162309CA	KSC1623 TP SAMSUNG SOT23 NP
		Q505	0TR162309CA	KSC1623 TP SAMSUNG SOT23 NP
		Q510	0TR390609FA	KST3906-MTF TP SAMSUNG SOT2
		Q601	0TR162309CA	KSC1623 TP SAMSUNG SOT23 NP
		Q602	0TR162309CA	KSC1623 TP SAMSUNG SOT23 NP
		Q901	0TR387500AA	CHIP 2SC3875S(ALY) BK KEC -
		Q902	0TR150400BA	CHIP 2SA1504S(ASY) BK KEC -
		Q903	0TR150400BA	CHIP 2SA1504S(ASY) BK KEC -
		Q904	0TR150400BA	CHIP 2SA1504S(ASY) BK KEC -

DATE: 2005. 05. 19.				
*S	*AL	LOC. NO.	PART NO.	DESCRIPTION / SPECIFICATION
		U601	0TFVI80023A	VISHAY SI3865DV R/TP TSOP-6
		U602	0TFVI80023A	VISHAY SI3865DV R/TP TSOP-6
		U603	0TFIR80009B	IRF7316 INTERNATIONAL RECTIF
		U607	0TFFC80009A	FAIRCHILD FDC6326L R/TP SOT-
RESISTORS				
		L708	0RH0000D622	0 OHM 1 / 10 W 2012 5.00% D
		L709	0RH0000D622	0 OHM 1 / 10 W 2012 5.00% D
		R1008	0RJ0000D677	0 OHM 1/10 W 5% 1608 R/TP
		R1009	0RJ0000D677	0 OHM 1/10 W 5% 1608 R/TP
		R1010	0RJ0000D677	0 OHM 1/10 W 5% 1608 R/TP
		R1011	0RJ0000D677	100 OHM 1/10 W 5% 1608 R/TP
		R1012	0RJ0000D677	0 OHM 1/10 W 5% 1608 R/TP
		R1013	0RJ0000D677	0 OHM 1/10 W 5% 1608 R/TP
		R1014	0RJ0000D677	0 OHM 1/10 W 5% 1608 R/TP
		R1015	0RH0000D622	0 OHM 1 / 10 W 2012 5.00% D
		R1016	0RJ0000D677	0 OHM 1/10 W 5% 1608 R/TP
		R1017	0RJ0000D677	0 OHM 1/10 W 5% 1608 R/TP
		R1018	0RH0222D622	22 OHM 1 / 10 W 2012 5.00% D
		R102	0RJ0752D677	75 OHM 1/10 W 5% 1608 R/TP
		R1020	0RH0222D622	22 OHM 1 / 10 W 2012 5.00% D
		R1021	0RJ1001D677	1K OHM 1/10 W 5% 1608 R/TP
		R1022	0RH4701D622	4.7K OHM 1 / 10 W 2012 5.00%
		R1024	0RH4701D622	4.7K OHM 1 / 10 W 2012 5.00%
		R1027	0RH1001D622	1K OHM 1 / 10 W 2012 5.00% D
		R1028	0RH0000D622	0 OHM 1 / 10 W 2012 5.00% D
		R1029	0RJ0000D677	0 OHM 1/10 W 5% 1608 R/TP
		R103	0RJ0752D677	75 OHM 1/10 W 5% 1608 R/TP
		R1030	0RJ4700D677	470 OHM 1/10 W 5% 1608 R/TP
		R1032	0RJ4701D677	4.7K OHM 1/10 W 5% 1608 R/TP
		R1033	0RJ1004D677	1000000 OHM 1/10 W 5% 1608 R
		R1035	0RJ0000D677	0 OHM 1/10 W 5% 1608 R/TP
		R1037	0RJ0000D677	0 OHM 1/10 W 5% 1608 R/TP
		R104	0RJ0752D677	75 OHM 1/10 W 5% 1608 R/TP
		R1041	0RH0000D622	0 OHM 1 / 10 W 2012 5.00% D
		R1043	0RJ4701D677	4.7K OHM 1/10 W 5% 1608 R/TP
		R1044	0RJ4701D677	4.7K OHM 1/10 W 5% 1608 R/TP
		R1045	0RJ4701D677	4.7K OHM 1/10 W 5% 1608 R/TP
		R1046	0RJ4701D677	4.7K OHM 1/10 W 5% 1608 R/TP
		R1049	0RJ0000D677	0 OHM 1/10 W 5% 1608 R/TP
		R105	0RJ0222D677	22 OHM 1/10 W 5% 1608 R/TP
		R1051	0RJ0000D677	0 OHM 1/10 W 5% 1608 R/TP
		R1052	0RJ0000D677	0 OHM 1/10 W 5% 1608 R/TP
		R1053	0RJ0000D677	0 OHM 1/10 W 5% 1608 R/TP
		R1054	0RJ0000D677	0 OHM 1/10 W 5% 1608 R/TP
		R106	0RJ0222D677	22 OHM 1/10 W 5% 1608 R/TP
		R1063	0RH0000D622	0 OHM 1 / 10 W 2012 5.00% D
		R1064	0RJ0000D677	0 OHM 1/10 W 5% 1608 R/TP
		R1070	0RH0000D622	0 OHM 1 / 10 W 2012 5.00% D
		R1072	0RH0000D622	0 OHM 1 / 10 W 2012 5.00% D
		R1073	0RJ0000D677	0 OHM 1/10 W 5% 1608 R/TP
		R1074	0RJ0000D677	0 OHM 1/10 W 5% 1608 R/TP
		R108	0RJ4701D677	4.7K OHM 1/10 W 5% 1608 R/TP
		R109	0RJ0000D677	0 OHM 1/10 W 5% 1608 R/TP
		R110	0RJ0222D677	22 OHM 1/10 W 5% 1608 R/TP
		R111	0RJ0562D677	56 OHM 1/10 W 5% 1608 R/TP
		R112	0RJ0562D677	56 OHM 1/10 W 5% 1608 R/TP
		R113	0RJ0000D677	0 OHM 1/10 W 5% 1608 R/TP
		R114	0RJ1002D677	10K OHM 1/10 W 5% 1608 R/TP
		R115	0RJ0562D677	56 OHM 1/10 W 5% 1608 R/TP
		R116	0RJ0000D677	0 OHM 1/10 W 5% 1608 R/TP

DATE: 2005. 05. 19.				
*S	*AL	LOC. NO.	PART NO.	DESCRIPTION / SPECIFICATION
		R118	0RJ1002D677	10K OHM 1/10 W 5% 1608 R/TP
		R119	0RJ0472D677	47 OHM 1/10 W 5% 1608 R/TP
		R120	0RJ0222D677	22 OHM 1/10 W 5% 1608 R/TP
		R122	0RJ0222D677	22 OHM 1/10 W 5% 1608 R/TP
		R124	0RJ0222D677	22 OHM 1/10 W 5% 1608 R/TP
		R126	0RJ0222D677	22 OHM 1/10 W 5% 1608 R/TP
		R128	0RJ0222D677	22 OHM 1/10 W 5% 1608 R/TP
		R130	0RJ0222D677	22 OHM 1/10 W 5% 1608 R/TP
		R132	0RJ0222D677	22 OHM 1/10 W 5% 1608 R/TP
		R134	0RJ0222D677	22 OHM 1/10 W 5% 1608 R/TP
		R136	0RJ4701D677	4.7K OHM 1/10 W 5% 1608 R/TP
		R137	0RJ4701D677	4.7K OHM 1/10 W 5% 1608 R/TP
		R138	0RJ4701D677	4.7K OHM 1/10 W 5% 1608 R/TP
		R139	0RJ4701D677	4.7K OHM 1/10 W 5% 1608 R/TP
		R140	0RJ4701D677	4.7K OHM 1/10 W 5% 1608 R/TP
		R141	0RJ4701D677	4.7K OHM 1/10 W 5% 1608 R/TP
		R142	0RJ4701D677	4.7K OHM 1/10 W 5% 1608 R/TP
		R143	0RJ4701D677	4.7K OHM 1/10 W 5% 1608 R/TP
		R144	0RJ0000D677	0 OHM 1/10 W 5% 1608 R/TP
		R145	0RJ0000D677	0 OHM 1/10 W 5% 1608 R/TP
		R146	0RJ1002D677	10K OHM 1/10 W 5% 1608 R/TP
		R147	0RJ1002D677	10K OHM 1/10 W 5% 1608 R/TP
		R148	0RJ1002D677	10K OHM 1/10 W 5% 1608 R/TP
		R149	0RJ1002D677	10K OHM 1/10 W 5% 1608 R/TP
		R150	0RJ4701D677	4.7K OHM 1/10 W 5% 1608 R/TP
		R151	0RJ1002D677	10K OHM 1/10 W 5% 1608 R/TP
		R152	0RJ8200D677	820 OHM 1/10 W 5% 1608 R/TP
		R153	0RJ0332D677	33 OHM 1/10 W 5% 1608 R/TP
		R154	0RJ0332D677	33 OHM 1/10 W 5% 1608 R/TP
		R155	0RJ0332D677	33 OHM 1/10 W 5% 1608 R/TP
		R156	0RJ0332D677	33 OHM 1/10 W 5% 1608 R/TP
		R158	0RH0000D622	0 OHM 1 / 10 W 2012 5.00% D
		R160	0RH0000D622	0 OHM 1 / 10 W 2012 5.00% D
		R201	0RJ1002D677	10K OHM 1/10 W 5% 1608 R/TP
		R202	0RJ1000D677	100 OHM 1/10 W 5% 1608 R/TP
		R203	0RJ1502D677	15K OHM 1/10 W 5% 1608 R/TP
		R204	0RJ2000D677	200 OHM 1/10 W 5% 1608 R/TP
		R205	0RJ3000D677	300 OHM 1/10 W 5% 1608 R/TP
		R206	0RJ2200D677	220 OHM 1/10 W 5% 1608 R/TP
		R207	0RJ4700D677	470 OHM 1/10 W 5% 1608 R/TP
		R208	0RJ1001D677	1K OHM 1/10 W 5% 1608 R/TP
		R210	0RJ5601D477	5.6K OHM 1/10 W 1% 1608 R/TP
		R215	0RJ3000D677	300 OHM 1/10 W 5% 1608 R/TP
		R217	0RJ3000D677	300 OHM 1/10 W 5% 1608 R/TP
		R218	0RJ2200D677	220 OHM 1/10 W 5% 1608 R/TP
		R221	0RJ2200D677	220 OHM 1/10 W 5% 1608 R/TP
		R223	0RJ2200D677	220 OHM 1/10 W 5% 1608 R/TP
		R227	0RJ6802D677	68K OHM 1/10 W 5% 1608 R/TP
		R228	0RJ1000D677	100 OHM 1/10 W 5% 1608 R/TP
		R229	0RJ1000D677	100 OHM 1/10 W 5% 1608 R/TP
		R239	0RJ2000D677	200 OHM 1/10 W 5% 1608 R/TP
		R243	0RJ3000D677	300 OHM 1/10 W 5% 1608 R/TP
		R253	0RH0102D622	10 OHM 1 / 10 W 2012 5.00% D
		R255	0RH1000D622	100 OHM 1 / 10 W 2012 5.00% D
		R256	0RH0000D622	0 OHM 1 / 10 W 2012 5.00% D
		R257	0RH1001D622	1K OHM 1 / 10 W 2012 5.00% D
		R259	0RH1000D622	100 OHM 1 / 10 W 2012 5.00%
		R260	0RH1000D622	100 OHM 1 / 10 W 2012 5.00%
		R261	0RH1000D622	100 OHM 1 / 10 W 2012 5.00%
		R270	0RJ2000D677	200 OHM 1/10 W 5% 1608 R/TP
		R271	0RJ3000D677	300 OHM 1/10 W 5% 1608 R/TP
		R272	0RJ1002D677	10K OHM 1/10 W 5% 1608 R/TP

DATE: 2005. 05. 19.				
*S	*AL	LOC. NO.	PART NO.	DESCRIPTION / SPECIFICATION
		R273	0RJ1000D677	100 OHM 1/10 W 5% 1608 R/TP
		R274	0RJ1002D677	10K OHM 1/10 W 5% 1608 R/TP
		R275	0RJ1000D677	100 OHM 1/10 W 5% 1608 R/TP
		R276	0RJ4700D677	470 OHM 1/10 W 5% 1608 R/TP
		R277	0RJ4700D677	470 OHM 1/10 W 5% 1608 R/TP
		R278	0RJ1001D677	1K OHM 1/10 W 5% 1608 R/TP
		R279	0RJ5601D477	5.6K OHM 1/10 W 1% 1608 R/TP
		R280	0RJ1002D677	10K OHM 1/10 W 5% 1608 R/TP
		R281	0RJ1000D677	100 OHM 1/10 W 5% 1608 R/TP
		R282	0RJ1002D677	10K OHM 1/10 W 5% 1608 R/TP
		R283	0RJ1000D677	100 OHM 1/10 W 5% 1608 R/TP
		R284	0RJ4700D677	470 OHM 1/10 W 5% 1608 R/TP
		R285	0RJ4700D677	470 OHM 1/10 W 5% 1608 R/TP
		R286	0RJ1001D677	1K OHM 1/10 W 5% 1608 R/TP
		R287	0RJ5601D477	5.6K OHM 1/10 W 1% 1608 R/TP
		R317	0RJ1500D677	150 OHM 1/10 W 5% 1608 R/TP
		R318	0RJ0752D677	75 OHM 1/10 W 5% 1608 R/TP
		R319	0RJ1500D677	150 OHM 1/10 W 5% 1608 R/TP
		R320	0RJ0752D677	75 OHM 1/10 W 5% 1608 R/TP
		R322	0RJ0752D677	75 OHM 1/10 W 5% 1608 R/TP
		R323	0RJ1500D677	150 OHM 1/10 W 5% 1608 R/TP
		R325	0RJ0222D677	22 OHM 1/10 W 5% 1608 R/TP
		R326	0RJ0222D677	22 OHM 1/10 W 5% 1608 R/TP
		R327	0RJ1001D677	1K OHM 1/10 W 5% 1608 R/TP
		R328	0RJ1001D677	1K OHM 1/10 W 5% 1608 R/TP
		R332	0RJ1001D677	1K OHM 1/10 W 5% 1608 R/TP
		R333	0RJ1001D677	1K OHM 1/10 W 5% 1608 R/TP
		R334	0RJ1001D677	1K OHM 1/10 W 5% 1608 R/TP
		R344	0RJ0000D677	0 OHM 1/10 W 5% 1608 R/TP
		R346	0RJ0000D677	0 OHM 1/10 W 5% 1608 R/TP
		R347	0RH0000D622	0 OHM 1 / 10 W 2012 5.00% D
		R400	0RJ1000D677	100 OHM 1/10 W 5% 1608 R/TP
		R401	0RJ1002D477	10K OHM 1/10 W 1% 1608 R/TP
		R402	0RJ1002D477	10K OHM 1/10 W 1% 1608 R/TP
		R403	0RJ1500D677	150 OHM 1/10 W 5% 1608 R/TP
		R408	0RJ2202D677	22K OHM 1/10 W 5% 1608 R/TP
		R409	0RH0000D622	0 OHM 1 / 10 W 2012 5.00% D
		R410	0RJ2700D477	270 OHM 1/10 W 1% 1608 R/TP
		R411	0RJ0222D677	22 OHM 1/10 W 5% 1608 R/TP
		R412	0RJ0222D677	22 OHM 1/10 W 5% 1608 R/TP
		R413	0RJ0222D677	22 OHM 1/10 W 5% 1608 R/TP
		R414	0RJ0000D677	0 OHM 1/10 W 5% 1608 R/TP
		R416	0RJ1000D677	100 OHM 1/10 W 5% 1608 R/TP
		R417	0RJ1000D677	100 OHM 1/10 W 5% 1608 R/TP
		R418	0RJ0000D677	0 OHM 1/10 W 5% 1608 R/TP
		R419	0RH0000D622	0 OHM 1 / 10 W 2012 5.00% D
		R420	0RJ0000D677	0 OHM 1/10 W 5% 1608 R/TP
		R421	0RH0000D622	0 OHM 1 / 10 W 2012 5.00% D
		R422	0RJ0000D677	0 OHM 1/10 W 5% 1608 R/TP
		R423	0RJ1002D677	10K OHM 1/10 W 5% 1608 R/TP
		R424	0RJ1002D677	10K OHM 1/10 W 5% 1608 R/TP
		R425	0RJ1002D677	10K OHM 1/10 W 5% 1608 R/TP
		R426	0RH2701D622	2.7K OHM 1 / 10 W 2012 5.00%
		R427	0RJ0000D677	0 OHM 1/10 W 5% 1608 R/TP
		R428	0RJ0000D677	0 OHM 1/10 W 5% 1608 R/TP
		R430	0RH1002D622	10K OHM 1 / 10 W 2012 5.00%
		R431	0RH3301D622	3.3K OHM 1 / 10 W 2012 5.00%
		R432	0RJ1002D677	10K OHM 1/10 W 5% 1608 R/TP
		R433	0RJ1001D677	1K OHM 1/10 W 5% 1608 R/TP
		R434	0RJ0000D677	0 OHM 1/10 W 5% 1608 R/TP
		R435	0RJ0000D677	0 OHM 1/10 W 5% 1608 R/TP
		R436	0RJ0000D677	0 OHM 1/10 W 5% 1608 R/TP

DATE: 2005. 05. 19.				
*S	*AL	LOC. NO.	PART NO.	DESCRIPTION / SPECIFICATION
		R437	0RJ0000D677	0 OHM 1/10 W 5% 1608 R/TP
		R438	0RJ0000D677	0 OHM 1/10 W 5% 1608 R/TP
		R440	0RH3301D622	3.3K OHM 1 / 10 W 2012 5.00%
		R441	0RJ1002D677	10K OHM 1/10 W 5% 1608 R/TP
		R442	0RJ1001D677	1K OHM 1/10 W 5% 1608 R/TP
		R443	0RJ4700D677	470 OHM 1/10 W 5% 1608 R/TP
		R444	0RH0000D622	0 OHM 1 / 10 W 2012 5.00% D
		R446	0RJ2202D677	22K OHM 1/10 W 5% 1608 R/TP
		R447	0RJ1002D677	10K OHM 1/10 W 5% 1608 R/TP
		R448	0RJ1002D677	10K OHM 1/10 W 5% 1608 R/TP
		R450	0RJ4700D677	470 OHM 1/10 W 5% 1608 R/TP
		R451	0RJ0000D677	0 OHM 1/10 W 5% 1608 R/TP
		R452	0RJ0000D677	0 OHM 1/10 W 5% 1608 R/TP
		R453	0RJ4700D677	470 OHM 1/10 W 5% 1608 R/TP
		R454	0RH0000D622	0 OHM 1 / 10 W 2012 5.00% D
		R455	0RH0000D622	0 OHM 1 / 10 W 2012 5.00% D
		R456	0RH2201D622	2.2K OHM 1 / 10 W 2012 5.00%
		R457	0RJ3302D677	33K OHM 1/10 W 5% 1608 R/TP
		R459	0RH2201D622	2.2K OHM 1 / 10 W 2012 5.00%
		R460	0RJ2201D677	2200 OHM 1/10 W 5% 1608 R/TP
		R461	0RJ2201D677	2200 OHM 1/10 W 5% 1608 R/TP
		R463	0RJ0332D677	33 OHM 1/10 W 5% 1608 R/TP
		R464	0RJ3301D677	3.3K OHM 1/10 W 5% 1608 R/TP
		R466	0RH4701D622	4.7K OHM 1 / 10 W 2012 5.00%
		R469	0RH0000D622	0 OHM 1 / 10 W 2012 5.00% D
		R470	0RH0000D622	0 OHM 1 / 10 W 2012 5.00% D
		R471	0RJ0000D677	0 OHM 1/10 W 5% 1608 R/TP
		R473	0RJ4700D677	470 OHM 1/10 W 5% 1608 R/TP
		R478	0RH0000D622	0 OHM 1 / 10 W 2012 5.00% D
		R479	0RJ0000D677	0 OHM 1/10 W 5% 1608 R/TP
		R480	0RJ0000D677	0 OHM 1/10 W 5% 1608 R/TP
		R481	0RJ0000D677	0 OHM 1/10 W 5% 1608 R/TP
		R482	0RJ1000D677	100 OHM 1/10 W 5% 1608 R/TP
		R483	0RJ0000D677	0 OHM 1/10 W 5% 1608 R/TP
		R488	0RJ0000D677	0 OHM 1/10 W 5% 1608 R/TP
		R489	0RH0000D622	0 OHM 1 / 10 W 2012 5.00% D
		R494	0RJ1000D677	100 OHM 1/10 W 5% 1608 R/TP
		R495	0RJ1000D677	100 OHM 1/10 W 5% 1608 R/TP
		R496	0RJ2201D677	2200 OHM 1/10 W 5% 1608 R/TP
		R497	0RJ2201D677	2200 OHM 1/10 W 5% 1608 R/TP
		R5001	0RJ4701D677	4.7K OHM 1/10 W 5% 1608 R/TP
		R5002	0RJ4701D677	4.7K OHM 1/10 W 5% 1608 R/TP
		R5003	0RJ0000D677	0 OHM 1/10 W 5% 1608 R/TP
		R5004	0RJ0000D677	0 OHM 1/10 W 5% 1608 R/TP
		R5005	0RJ4701D677	4.7K OHM 1/10 W 5% 1608 R/TP
		R5006	0RJ1001D677	1K OHM 1/10 W 5% 1608 R/TP
		R5007	0RJ1001D677	1K OHM 1/10 W 5% 1608 R/TP
		R5008	0RJ0000D677	0 OHM 1/10 W 5% 1608 R/TP
		R501	0RJ1001D677	1K OHM 1/10 W 5% 1608 R/TP
		R5010	0RJ0000D677	0 OHM 1/10 W 5% 1608 R/TP
		R5011	0RJ0000D677	0 OHM 1/10 W 5% 1608 R/TP
		R5013	0RJ0000D677	0 OHM 1/10 W 5% 1608 R/TP
		R5014	0RJ0000D677	0 OHM 1/10 W 5% 1608 R/TP
		R5015	0RJ1002D677	10K OHM 1/10 W 5% 1608 R/TP
		R502	0RJ1001D677	1K OHM 1/10 W 5% 1608 R/TP
		R503	0RJ1001D677	1K OHM 1/10 W 5% 1608 R/TP
		R504	0RJ1001D677	1K OHM 1/10 W 5% 1608 R/TP
		R505	0RJ1001D677	1K OHM 1/10 W 5% 1608 R/TP
		R506	0RJ1001D677	1K OHM 1/10 W 5% 1608 R/TP
		R508	0RJ3301D677	3.3K OHM 1/10 W 5% 1608 R/TP
		R509	0RJ1001D677	1K OHM 1/10 W 5% 1608 R/TP
		R510	0RJ1000D677	100 OHM 1/10 W 5% 1608 R/TP

DATE: 2005. 05. 19.				
*S	*AL	LOC. NO.	PART NO.	DESCRIPTION / SPECIFICATION
		R511	0RJ1000D677	100 OHM 1/10 W 5% 1608 R/TP
		R512	0RJ1001D677	1K OHM 1/10 W 5% 1608 R/TP
		R514	0RJ1001D677	1K OHM 1/10 W 5% 1608 R/TP
		R519	0RJ0000D677	0 OHM 1/10 W 5% 1608 R/TP
		R521	0RJ3302D677	33K OHM 1/10 W 5% 1608 R/TP
		R522	0RJ1001D677	1K OHM 1/10 W 5% 1608 R/TP
		R523	0RJ2002D677	20000 OHM 1/10 W 5% 1608 R/T
		R524	0RJ3302D677	33K OHM 1/10 W 5% 1608 R/TP
		R526	0RJ2002D677	20000 OHM 1/10 W 5% 1608 R/T
		R527	0RJ1203D677	120K OHM 1/10 W 5% 1608 R/TP
		R528	0RJ1203D677	120K OHM 1/10 W 5% 1608 R/TP
		R529	0RJ1002D677	10K OHM 1/10 W 5% 1608 R/TP
		R530	0RJ1001D677	1K OHM 1/10 W 5% 1608 R/TP
		R531	0RJ1001D677	1K OHM 1/10 W 5% 1608 R/TP
		R534	0RJ2402D677	24K OHM 1/10 W 5% 1608 R/TP
		R535	0RJ2002D477	20K OHM 1/10 W 1% 1608 R/TP
		R536	0RJ0000D677	0 OHM 1/10 W 5% 1608 R/TP
		R537	0RJ2402D677	24K OHM 1/10 W 5% 1608 R/TP
		R538	0RJ2402D677	24K OHM 1/10 W 5% 1608 R/TP
		R539	0RJ3302D477	33K OHM 1/10 W 1% 1608 R/TP
		R540	0RH0000D622	0 OHM 1 / 10 W 2012 5.00% D
		R541	0RJ1000D677	100 OHM 1/10 W 5% 1608 R/TP
		R542	0RH0000D622	0 OHM 1 / 10 W 2012 5.00% D
		R543	0RH0000D622	0 OHM 1 / 10 W 2012 5.00% D
		R544	0RJ1000D677	100 OHM 1/10 W 5% 1608 R/TP
		R545	0RJ3302D677	33K OHM 1/10 W 5% 1608 R/TP
		R546	0RH0000D622	0 OHM 1 / 10 W 2012 5.00% D
		R550	0RJ2002D677	20000 OHM 1/10 W 5% 1608 R/T
		R551	0RJ3302D677	33K OHM 1/10 W 5% 1608 R/TP
		R552	0RJ2702D677	27K OHM 1/10 W 5% 1608 R/TP
		R554	0RJ2002D677	20000 OHM 1/10 W 5% 1608 R/T
		R556	0RJ1001D677	1K OHM 1/10 W 5% 1608 R/TP
		R557	0RJ1001D677	1K OHM 1/10 W 5% 1608 R/TP
		R558	0RJ1000D677	100 OHM 1/10 W 5% 1608 R/TP
		R559	0RJ1000D677	100 OHM 1/10 W 5% 1608 R/TP
		R560	0RJ1000D677	100 OHM 1/10 W 5% 1608 R/TP
		R561	0RJ1000D677	100 OHM 1/10 W 5% 1608 R/TP
		R562	0RJ0000D677	0 OHM 1/10 W 5% 1608 R/TP
		R565	0RJ0000D677	0 OHM 1/10 W 5% 1608 R/TP
		R579	0RJ1002D677	10K OHM 1/10 W 5% 1608 R/TP
		R580	0RJ1002D677	10K OHM 1/10 W 5% 1608 R/TP
		R581	0RJ1002D677	10K OHM 1/10 W 5% 1608 R/TP
		R583	0RJ1002D677	10K OHM 1/10 W 5% 1608 R/TP
		R585	0RJ1002D677	10K OHM 1/10 W 5% 1608 R/TP
		R586	0RJ1002D677	10K OHM 1/10 W 5% 1608 R/TP
		R587	0RJ1002D677	10K OHM 1/10 W 5% 1608 R/TP
		R588	0RJ1002D677	10K OHM 1/10 W 5% 1608 R/TP
		R592	0RJ1002D677	10K OHM 1/10 W 5% 1608 R/TP
		R593	0RJ1002D677	10K OHM 1/10 W 5% 1608 R/TP
		R595	0RJ1002D677	10K OHM 1/10 W 5% 1608 R/TP
		R597	0RJ1002D677	10K OHM 1/10 W 5% 1608 R/TP
		R603	0RJ3301D677	3.3K OHM 1/10 W 5% 1608 R/TP
		R604	0RJ1002D677	10K OHM 1/10 W 5% 1608 R/TP
		R605	0RJ2201D677	2200 OHM 1/10 W 5% 1608 R/TP
		R608	0RJ1802D677	18K OHM 1/10 W 5% 1608 R/TP
		R609	0RJ1802D677	18K OHM 1/10 W 5% 1608 R/TP
		R610	0RJ1802D677	18K OHM 1/10 W 5% 1608 R/TP
		R611	0RJ1802D677	18K OHM 1/10 W 5% 1608 R/TP
		R612	0RJ1802D677	18K OHM 1/10 W 5% 1608 R/TP
		R613	0RJ2202D677	22K OHM 1/10 W 5% 1608 R/TP
		R615	0RJ1500D677	150 OHM 1/10 W 5% 1608 R/TP
		R624	0RJ0222D677	22 OHM 1/10 W 5% 1608 R/TP

DATE: 2005. 05. 19.				
*S	*AL	LOC. NO.	PART NO.	DESCRIPTION / SPECIFICATION
		R625	0RJ4701D677	4.7K OHM 1/10 W 5% 1608 R/TP
		R627	0RJ0222D677	22 OHM 1/10 W 5% 1608 R/TP
		R634	0RJ1001D677	1K OHM 1/10 W 5% 1608 R/TP
		R635	0RJ0000D677	0 OHM 1/10 W 5% 1608 R/TP
		R636	0RJ1000D677	100 OHM 1/10 W 5% 1608 R/TP
		R638	0RJ0000D677	0 OHM 1/10 W 5% 1608 R/TP
		R639	0RJ2202D677	22K OHM 1/10 W 5% 1608 R/TP
		R640	0RJ5600D677	560 OHM 1/10 W 5% 1608 R/TP
		R641	0RJ2202D677	22K OHM 1/10 W 5% 1608 R/TP
		R642	0RJ5600D677	560 OHM 1/10 W 5% 1608 R/TP
		R701	0RJ0000D677	0 OHM 1/10 W 5% 1608 R/TP
		R702	0RJ4703D677	470K OHM 1/10 W 5% 1608 R/TP
		R703	0RJ4703D677	470K OHM 1/10 W 5% 1608 R/TP
		R704	0RJ0000D677	0 OHM 1/10 W 5% 1608 R/TP
		R705	0RJ4703D677	470K OHM 1/10 W 5% 1608 R/TP
		R706	0RJ4703D677	470K OHM 1/10 W 5% 1608 R/TP
		R707	0RJ0752D677	75 OHM 1/10 W 5% 1608 R/TP
		R708	0RJ0752D677	75 OHM 1/10 W 5% 1608 R/TP
		R709	0RJ4703D677	470K OHM 1/10 W 5% 1608 R/TP
		R710	0RJ4703D677	470K OHM 1/10 W 5% 1608 R/TP
		R711	0RJ0752D677	75 OHM 1/10 W 5% 1608 R/TP
		R712	0RJ0822D677	82 OHM 1/10 W 5% 1608 R/TP
		R713	0RJ0752D677	75 OHM 1/10 W 5% 1608 R/TP
		R714	0RJ0472D677	47 OHM 1/10 W 5% 1608 R/TP
		R715	0RJ0822D677	82 OHM 1/10 W 5% 1608 R/TP
		R716	0RJ0752D677	75 OHM 1/10 W 5% 1608 R/TP
		R717	0RJ0752D677	75 OHM 1/10 W 5% 1608 R/TP
		R718	0RJ0752D677	75 OHM 1/10 W 5% 1608 R/TP
		R719	0RJ0822D677	82 OHM 1/10 W 5% 1608 R/TP
		R720	0RJ0752D677	75 OHM 1/10 W 5% 1608 R/TP
		R721	0RJ0222D677	22 OHM 1/10 W 5% 1608 R/TP
		R722	0RJ0752D677	75 OHM 1/10 W 5% 1608 R/TP
		R723	0RJ0752D677	75 OHM 1/10 W 5% 1608 R/TP
		R724	0RJ0752D677	75 OHM 1/10 W 5% 1608 R/TP
		R725	0RJ0222D677	22 OHM 1/10 W 5% 1608 R/TP
		R726	0RJ0222D677	22 OHM 1/10 W 5% 1608 R/TP
		R727	0RH1001D622	1K OHM 1 / 10 W 2012 5.00% D
		R728	0RH1001D622	1K OHM 1 / 10 W 2012 5.00% D
		R729	0RJ5600D677	560 OHM 1/10 W 5% 1608 R/TP
		R730	0RJ5600D677	560 OHM 1/10 W 5% 1608 R/TP
		R731	0RJ5600D677	560 OHM 1/10 W 5% 1608 R/TP
		R733	0RJ1002D677	10K OHM 1/10 W 5% 1608 R/TP
		R734	0RJ1002D677	10K OHM 1/10 W 5% 1608 R/TP
		R735	0RJ0752D677	75 OHM 1/10 W 5% 1608 R/TP
		R836	0RJ0000D677	0 OHM 1/10 W 5% 1608 R/TP
		R838	0RJ0000D677	0 OHM 1/10 W 5% 1608 R/TP
		R901	0RJ0222D677	22 OHM 1/10 W 5% 1608 R/TP
		R903	0RH0000D622	0 OHM 1 / 10 W 2012 5.00% D
		R906	0RJ0222D677	22 OHM 1/10 W 5% 1608 R/TP
		R907	0RJ0222D677	22 OHM 1/10 W 5% 1608 R/TP
		R908	0RJ0332D677	33 OHM 1/10 W 5% 1608 R/TP
		R909	0RJ4701D677	4.7K OHM 1/10 W 5% 1608 R/TP
		R910	0RJ4701D677	4.7K OHM 1/10 W 5% 1608 R/TP
		R911	0RJ4701D677	4.7K OHM 1/10 W 5% 1608 R/TP
		R912	0RJ1001D677	1K OHM 1/10 W 5% 1608 R/TP
		R913	0RH1000D622	100 OHM 1 / 10 W 2012 5.00%
		R914	0RH1000D622	100 OHM 1 / 10 W 2012 5.00%
		R915	0RJ3300D677	330 OHM 1/10 W 5% 1608 R/TP
		R916	0RJ3300D677	330 OHM 1/10 W 5% 1608 R/TP
		R917	0RJ3300D677	330 OHM 1/10 W 5% 1608 R/TP
		R918	0RJ3300D677	330 OHM 1/10 W 5% 1608 R/TP
		R919	0RJ3300D677	330 OHM 1/10 W 5% 1608 R/TP

DATE: 2005. 05. 19.				
*S	*AL	LOC. NO.	PART NO.	DESCRIPTION / SPECIFICATION
		R920	0RJ4700D677	470 OHM 1/10 W 5% 1608 R/TP
		R924	0RJ1000D677	100 OHM 1/10 W 5% 1608 R/TP
		R925	0RJ1000D677	100 OHM 1/10 W 5% 1608 R/TP
		R926	0RJ1000D677	100 OHM 1/10 W 5% 1608 R/TP
		R927	0RJ1000D677	100 OHM 1/10 W 5% 1608 R/TP
		R928	0RH0000D622	0 OHM 1 / 10 W 2012 5.00% D
		R931	0RH0000D622	0 OHM 1 / 10 W 2012 5.00% D
		R932	0RH0000D622	0 OHM 1 / 10 W 2012 5.00% D
		R933	0RJ0000D677	0 OHM 1/10 W 5% 1608 R/TP
		R934	0RJ0000D677	0 OHM 1/10 W 5% 1608 R/TP
		R935	0RJ1000D677	100 OHM 1/10 W 5% 1608 R/TP
		R936	0RJ5601D477	5.6K OHM 1/10 W 1% 1608 R/TP
		R937	0RJ1001D677	1K OHM 1/10 W 5% 1608 R/TP
		R938	0RH0000D622	0 OHM 1 / 10 W 2012 5.00% D
		R939	0RJ2200D677	220 OHM 1/10 W 5% 1608 R/TP
		R940	0RJ3600D477	360 OHM 1/10 W 1% 1608 R/TP
		R941	0RJ1000D677	100 OHM 1/10 W 5% 1608 R/TP
		R944	0RJ1000D677	100 OHM 1/10 W 5% 1608 R/TP
		R945	0RJ2200D677	220 OHM 1/10 W 5% 1608 R/TP
		R946	0RJ1000D677	100 OHM 1/10 W 5% 1608 R/TP
		R947	0RJ1002D677	10K OHM 1/10 W 5% 1608 R/TP
		R948	0RJ1002D677	10K OHM 1/10 W 5% 1608 R/TP
		R949	0RJ4700D677	470 OHM 1/10 W 5% 1608 R/TP
		R950	0RJ3600D477	360 OHM 1/10 W 1% 1608 R/TP
		R952	0RJ0000D677	0 OHM 1/10 W 5% 1608 R/TP
		R953	0RJ0000D677	0 OHM 1/10 W 5% 1608 R/TP
		R955	0RJ0000D677	0 OHM 1/10 W 5% 1608 R/TP
		R960	0RJ3300D677	330 OHM 1/10 W 5% 1608 R/TP
		R961	0RH3300D622	330 OHM 1 / 10 W 2012 5.00%
		R962	0RJ1000D677	100 OHM 1/10 W 5% 1608 R/TP
		R963	0RJ1005D677	10M OHM 1/10 W 5% 1608 R/TP
		R965	0RJ1000D677	100 OHM 1/10 W 5% 1608 R/TP
		R966	0RJ3300D677	330 OHM 1/10 W 5% 1608 R/TP
		RA1007	0RHZTCZ001A	RCA SMART 100OHM 1/16 W 5% 3
		RA1008	0RHZTCZ001A	RCA SMART 100OHM 1/16 W 5% 3
		RA1009	0RHZTCZ001A	RCA SMART 100OHM 1/16 W 5% 3
		RA1010	0RHZTCZ001A	RCA SMART 100OHM 1/16 W 5% 3
		RA301	0RHZTCZ001D	RCA SMART 22OHM 1/16 W 5% 32
		RA305	0RHZTCZ001D	RCA SMART 22OHM 1/16 W 5% 32
		RA307	0RHZTCZ001D	RCA SMART 22OHM 1/16 W 5% 32
		RA308	0RHZTCZ001D	RCA SMART 22OHM 1/16 W 5% 32
		RA309	0RHZTCZ001D	RCA SMART 22OHM 1/16 W 5% 32
		RA325	0RHZTCZ001D	RCA SMART 22OHM 1/16 W 5% 32
		RA401	0RHZTCZ001D	RCA SMART 22OHM 1/16 W 5% 32
		RA402	0RHZTCZ001D	RCA SMART 22OHM 1/16 W 5% 32
		RA403	0RHZTCZ001D	RCA SMART 22OHM 1/16 W 5% 32
		RA404	0RHZTCZ001D	RCA SMART 22OHM 1/16 W 5% 32
		RA405	0RHZTCZ001D	RCA SMART 22OHM 1/16 W 5% 32
		RA406	0RHZTCZ001D	RCA SMART 22OHM 1/16 W 5% 32
		RA407	0RHZTCZ001D	RCA SMART 22OHM 1/16 W 5% 32
		RA408	0RHZTCZ001D	RCA SMART 22OHM 1/16 W 5% 32
		RA409	0RHZTCZ001D	RCA SMART 22OHM 1/16 W 5% 32
		RA410	0RHZTCZ001D	RCA SMART 22OHM 1/16 W 5% 32
		RA411	0RHZTCZ001D	RCA SMART 22OHM 1/16 W 5% 32
		RA412	0RHZTCZ001G	RCA SMART 00HM 1/16 W 5% 321
		RA413	0RHZTCZ001G	RCA SMART 00HM 1/16 W 5% 321
		RA414	0RHZTCZ001G	RCA SMART 00HM 1/16 W 5% 321
		RA901	0RHZTCZ001D	RCA SMART 22OHM 1/16 W 5% 32
		RA902	0RHZTCZ001D	RCA SMART 22OHM 1/16 W 5% 32
		RA903	0RHZTCZ001D	RCA SMART 22OHM 1/16 W 5% 32
		RA904	0RHZTCZ001D	RCA SMART 22OHM 1/16 W 5% 32
		RA905	0RHZTCZ001D	RCA SMART 22OHM 1/16 W 5% 32

DATE: 2005. 05. 19.				
*S	*AL	LOC. NO.	PART NO.	DESCRIPTION / SPECIFICATION
		RA906	0RHZTCZ001D	RCA SMART 220OHM 1/16 W 5% 32
		RA907	0RHZTCZ001D	RCA SMART 220OHM 1/16 W 5% 32
		RA908	0RHZTCZ001D	RCA SMART 220OHM 1/16 W 5% 32
		RA909	0RHZTCZ001D	RCA SMART 220OHM 1/16 W 5% 32
		RA910	0RHZTCZ001D	RCA SMART 220OHM 1/16 W 5% 32
		RA911	0RHZTCZ001D	RCA SMART 220OHM 1/16 W 5% 32
		RA912	0RHZTCZ001D	RCA SMART 220OHM 1/16 W 5% 32
		RA913	0RHZTCZ001D	RCA SMART 220OHM 1/16 W 5% 32
		RA914	0RHZTCZ001D	RCA SMART 220OHM 1/16 W 5% 32
		RA915	0RHZTCZ001D	RCA SMART 220OHM 1/16 W 5% 32
		RA916	0RHZTCZ001A	RCA SMART 100OHM 1/16 W 5% 3
		RA917	0RHZTCZ001A	RCA SMART 100OHM 1/16 W 5% 3
		RA918	0RHZTCZ001A	RCA SMART 100OHM 1/16 W 5% 3
		RA919	0RHZTCZ001A	RCA SMART 100OHM 1/16 W 5% 3
		RA920	0RHZTCZ001A	RCA SMART 100OHM 1/16 W 5% 3
		RA921	0RHZTCZ001A	RCA SMART 100OHM 1/16 W 5% 3
		RA922	0RHZTCZ001A	RCA SMART 100OHM 1/16 W 5% 3
		RA923	0RHZTCZ001A	RCA SMART 100OHM 1/16 W 5% 3
		RA924	0RHZTCZ001A	RCA SMART 100OHM 1/16 W 5% 3
		RA925	0RHZTCZ001A	RCA SMART 100OHM 1/16 W 5% 3
		RA926	0RHZTCZ001A	RCA SMART 100OHM 1/16 W 5% 3
		RA927	0RHZTCZ001A	RCA SMART 100OHM 1/16 W 5% 3
		RA928	0RHZTCZ001A	RCA SMART 100OHM 1/16 W 5% 3
		RA929	0RHZTCZ001A	RCA SMART 100OHM 1/16 W 5% 3
OTHERs				
		L703	0LC2000005D	"F1-B2012-332KJT,3.3 UH CERAT"
		L910	0LC1532101A	15UH 10% 3216 R/TC FI-C3216-
		L912	0LCTA00006E	"LEM2520T390J, 39UH TAIYOYUDE"
		X1001	6202TTT001A	"HC-49/U, SUNNY RADIAL 800000"
		X401	6202TST001A	"SX-1 SUNNY ,SMS, 14.31818MHZ"
		X516	6202TST003B	HC-49/SM5H KONY CHIP 18.432M
		X901	6202TST001H	SX-1 SUNNY 27MHZ +/- 30 PPM
		X902	6212AB2806A	SX-1 SUNNY 24.576MHZ +/- 50
CONTROL BOARD				
		LED1	0DLLT0089AA	LITEON LTL-1BEDJ-0C2 TP GREE
		SW1	140-058B	EVQ PB2 05K MATUSHITA NON 12
		SW2	140-058B	EVQ PB2 05K MATUSHITA NON 12
		SW3	140-058B	EVQ PB2 05K MATUSHITA NON 12
		SW4	140-058B	EVQ PB2 05K MATUSHITA NON 12
		SW5	140-058B	EVQ PB2 05K MATUSHITA NON 12
		SW6	140-058B	EVQ PB2 05K MATUSHITA NON 12
		SW7	140-058B	EVQ PB2 05K MATUSHITA NON 12
		SW8	140-058B	EVQ PB2 05K MATUSHITA NON 12
		C2	0CK105CF94A	"1UF 1608 16V 80%,-20% R/TP F"
		C3	0CK105CF94A	"1UF 1608 16V 80%,-20% R/TP F"
		C4	0CK104CK56A	0.1UF 1608 50V 10% R/TP X7R
		C5	0CK104CK56A	0.1UF 1608 50V 10% R/TP X7R
		ZD1	0DZ560009DA	UDZ S 5.6B TP ROHM-K SOD323
		ZD2	0DZ560009DA	UDZ S 5.6B TP ROHM-K SOD323
		ZD4	0DZ560009DA	UDZ S 5.6B TP ROHM-K SOD323
		ZD5	0DZ560009DA	UDZ S 5.6B TP ROHM-K SOD323
		L1	0RH1000D622	100 OHM 1 / 10 W 2012 5.00%
		R1	0RJ0562D677	56 OHM 1/10 W 5% 1608 R/TP
		R10	0RJ2001D677	2K OHM 1/10 W 5% 1608 R/TP
		R2	0RJ0562D677	56 OHM 1/10 W 5% 1608 R/TP
		R3	0RJ4701D677	4.7K OHM 1/10 W 5% 1608 R/TP
		R4	0RJ4701D677	4.7K OHM 1/10 W 5% 1608 R/TP
		R5	0RJ8200D677	820 OHM 1/10 W 5% 1608 R/TP

DATE: 2005. 05. 19.				
*S	*AL	LOC. NO.	PART NO.	DESCRIPTION / SPECIFICATION
		R6	0RJ8200D677	820 OHM 1/10 W 5% 1608 R/TP
		R7	0RJ1501D677	1.5K OHM 1/10 W 5% 1608 R/TP
		R8	0RJ1501D677	1.5K OHM 1/10 W 5% 1608 R/TP
		R9	0RJ2001D677	2K OHM 1/10 W 5% 1608 R/TP
LED & POWER BOARD				
		ZD801	0DZ560009DA	UDZ S 5.6B TP ROHM-K SOD323
		Q801	0TR390409AE	FAIRCHILD KST3904(LGEMTF) TP
		Q802	0TR390609FA	KST3906-MTF TP SAMSUNG SOT2
		Q803	0TR390609FA	KST3906-MTF TP SAMSUNG SOT2
		R801	0RH1002D622	10K OHM 1 / 10 W 2012 5.00%
		R802	0RH4701D622	4.7K OHM 1 / 10 W 2012 5.00%
		R803	0RH4701D622	4.7K OHM 1 / 10 W 2012 5.00%
		R804	0RH5100D622	510 OHM 1 / 10 W 2012 5.00%
		R805	0RH5100D622	510 OHM 1 / 10 W 2012 5.00%
		R806	0RH5100D622	510 OHM 1 / 10 W 2012 5.00%
		R807	0RH5100D622	510 OHM 1 / 10 W 2012 5.00%
		R808	0RH5100D622	510 OHM 1 / 10 W 2012 5.00%
		R809	0RH5100D622	510 OHM 1 / 10 W 2012 5.00%
		R810	0RH5100D622	510 OHM 1 / 10 W 2012 5.00%
		R811	0RH5100D622	510 OHM 1 / 10 W 2012 5.00%
		R812	0RH5100D622	510 OHM 1 / 10 W 2012 5.00%
		R813	0RH5100D622	510 OHM 1 / 10 W 2012 5.00%
		R814	0RH5100D622	510 OHM 1 / 10 W 2012 5.00%
		R815	0RH5100D622	510 OHM 1 / 10 W 2012 5.00%
		R816	0RH5100D622	510 OHM 1 / 10 W 2012 5.00%
		R817	0RH5100D622	510 OHM 1 / 10 W 2012 5.00%
		R818	0RH5100D622	510 OHM 1 / 10 W 2012 5.00%
		R819	0RH5100D622	510 OHM 1 / 10 W 2012 5.00%
		R820	0RH5100D622	510 OHM 1 / 10 W 2012 5.00%
		R821	0RH5100D622	510 OHM 1 / 10 W 2012 5.00%
		R822	0RH5100D622	510 OHM 1 / 10 W 2012 5.00%
		R823	0RH5100D622	510 OHM 1 / 10 W 2012 5.00%
		R824	0RH5100D622	510 OHM 1 / 10 W 2012 5.00%
		R825	0RH5100D622	510 OHM 1 / 10 W 2012 5.00%
		R826	0RH5100D622	510 OHM 1 / 10 W 2012 5.00%
		R827	0RH5100D622	510 OHM 1 / 10 W 2012 5.00%
		U1	6726TV0001A	TSOP4838SO1 VISHAY 38.0KHZ L
		LED801	0DLNC0058AA	NICHIA NSCW215T R/TP WHITE 6
		LED802	0DLNC0058AA	NICHIA NSCW215T R/TP WHITE 6
		LED803	0DLNC0058AA	NICHIA NSCW215T R/TP WHITE 6
		LED804	0DLNC0058AA	NICHIA NSCW215T R/TP WHITE 6
		LED805	0DLNC0058AA	NICHIA NSCW215T R/TP WHITE 6
		LED806	0DLNC0058AA	NICHIA NSCW215T R/TP WHITE 6
		LED807	0DLNC0058AA	NICHIA NSCW215T R/TP WHITE 6
		LED808	0DLNC0058AA	NICHIA NSCW215T R/TP WHITE 6
		LED809	0DLNC0058AA	NICHIA NSCW215T R/TP WHITE 6
		LED810	0DLNC0058AA	NICHIA NSCW215T R/TP WHITE 6
		LED811	0DLNC0058AA	NICHIA NSCW215T R/TP WHITE 6
		LED812	0DLNC0058AA	NICHIA NSCW215T R/TP WHITE 6

SCHEMATIC DIAGRAM

1. D-SUB/DVI-D INPUT

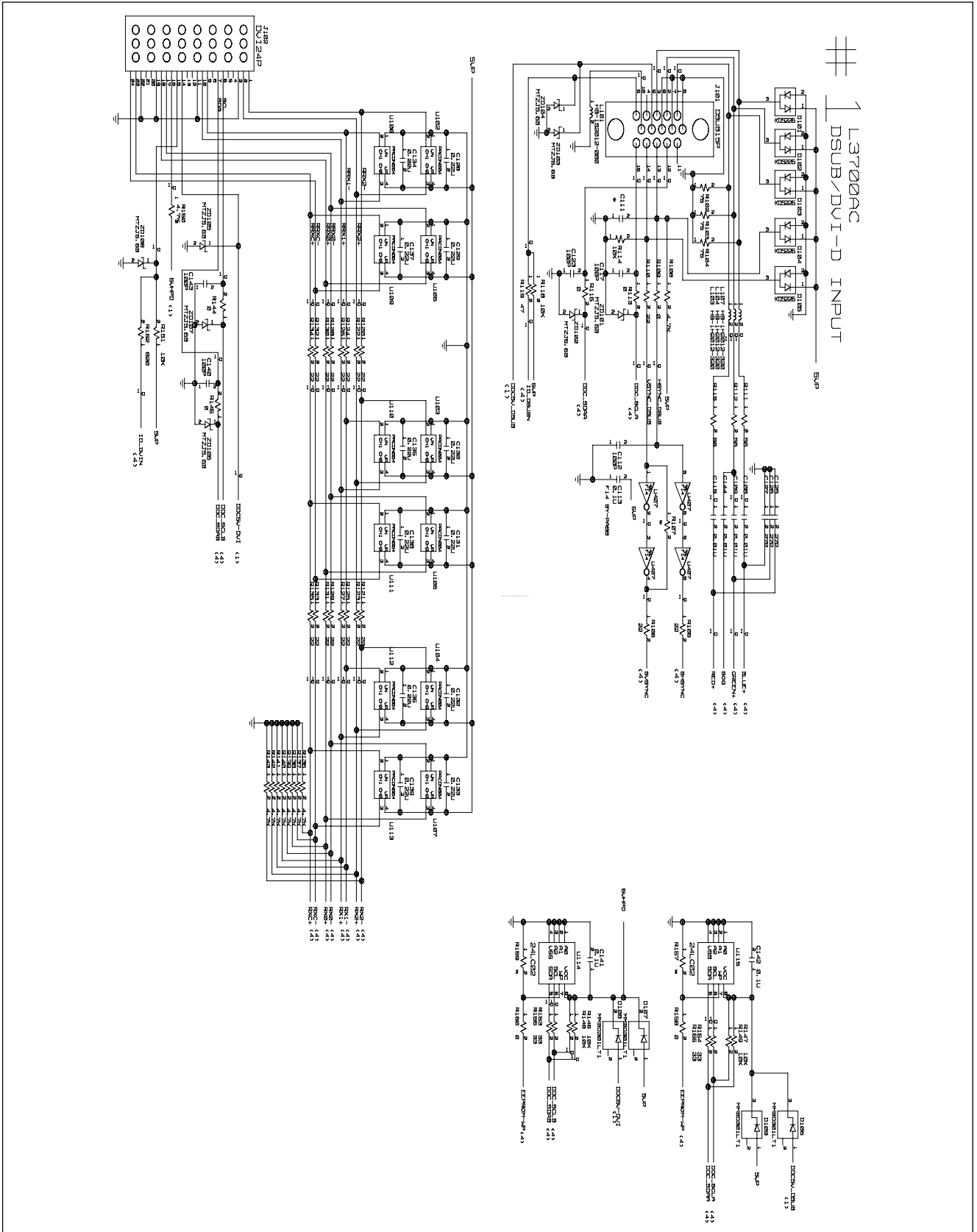

2. VIDEO SWITCH (CXA2040) / TUNER (TV OPTION)

#2 L370DAC DEC(UCT49X11) / TUNER

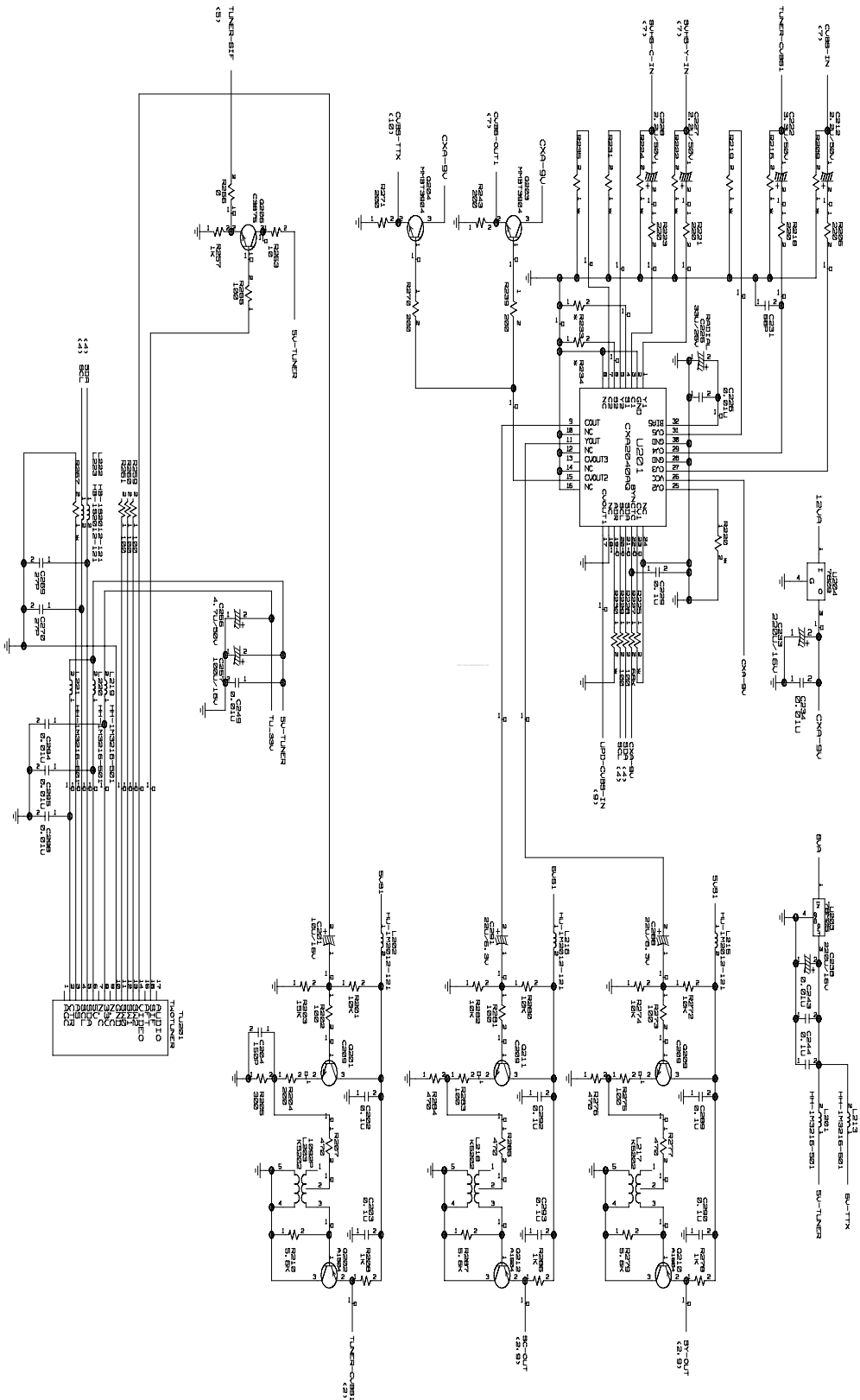

3. MST9883

3 L3700AC
MST9883

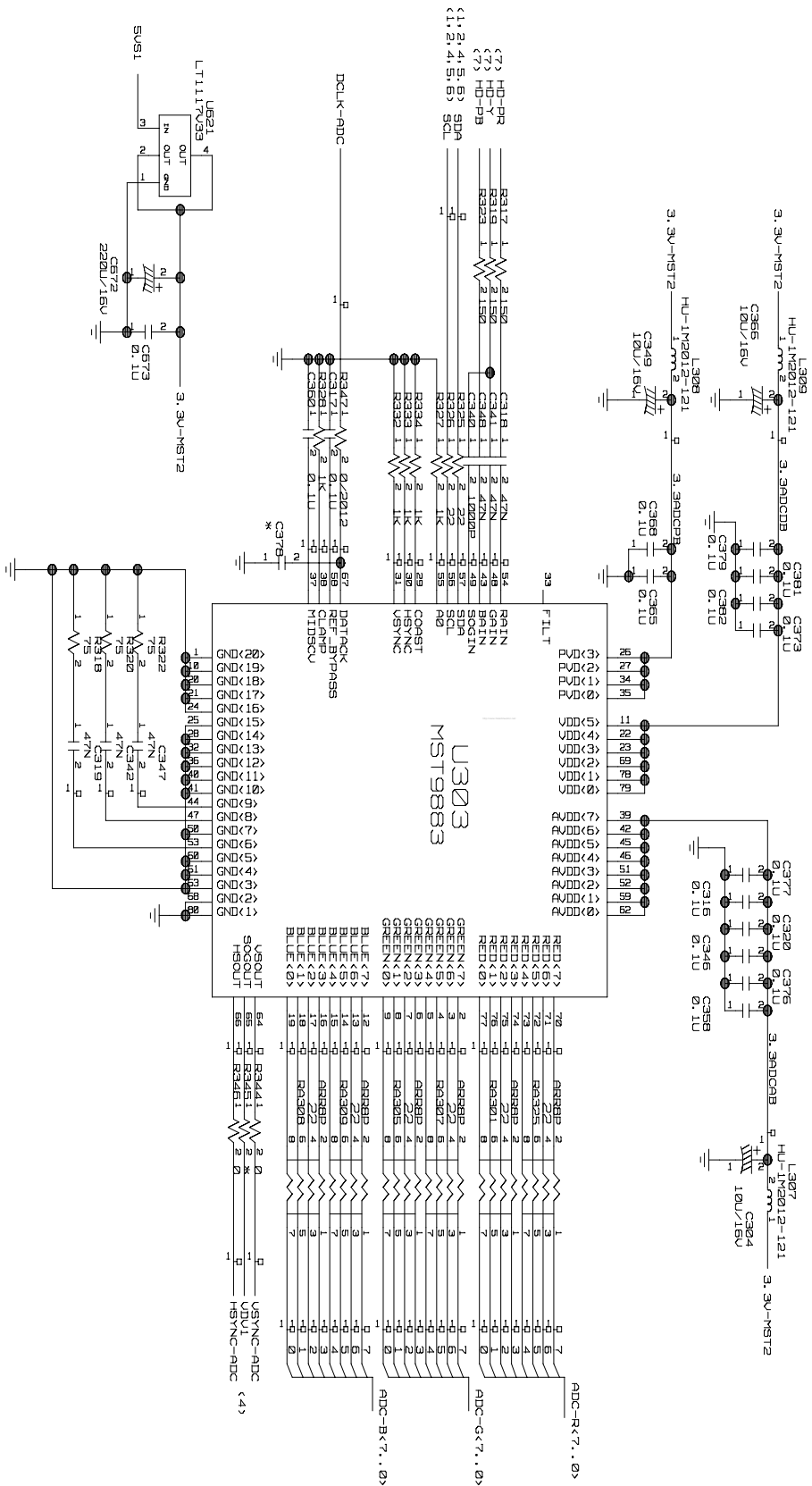

4. SCALER(GM1601)

4 L37090C
SCALER(GM1601)

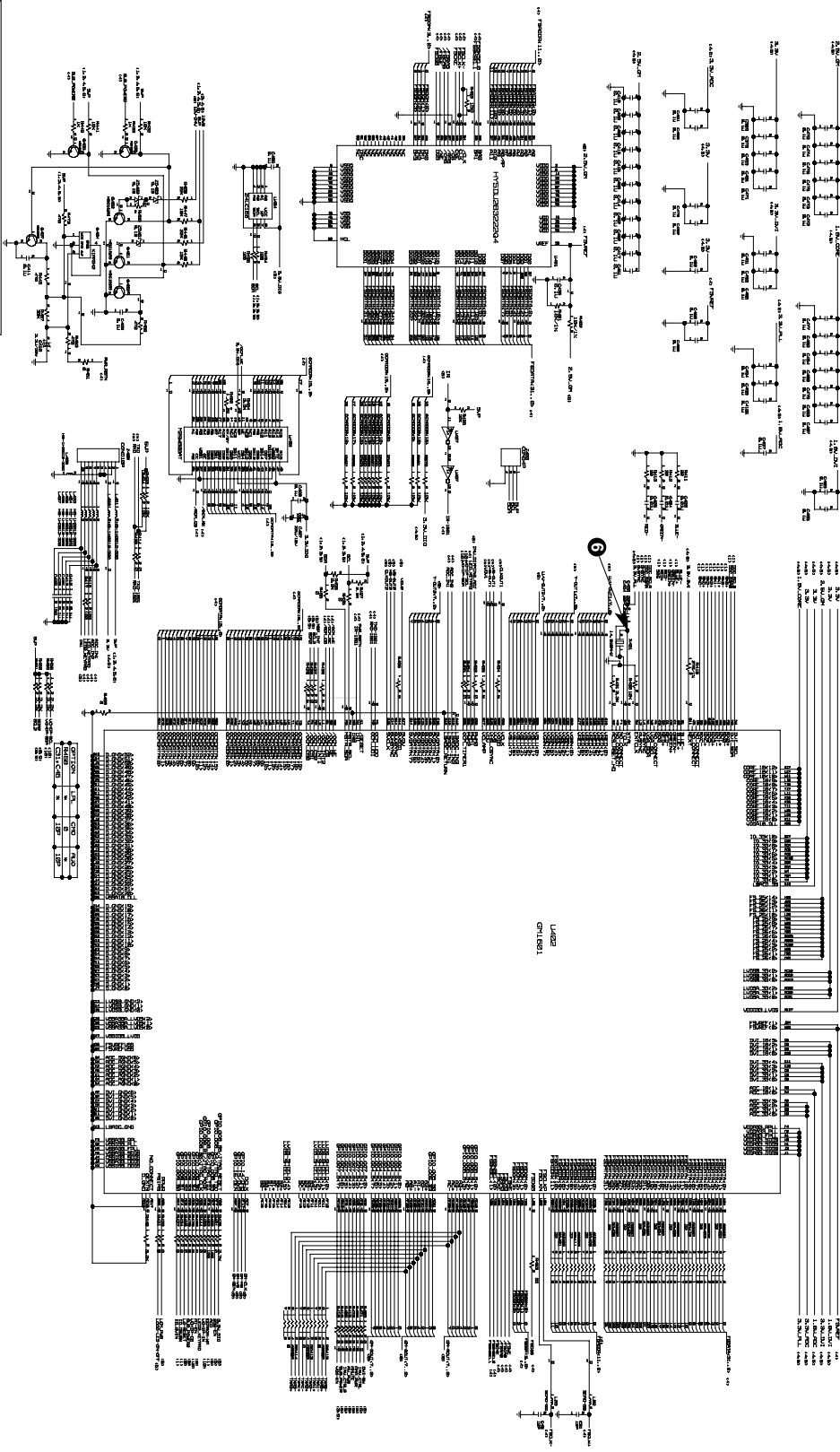

6 X401

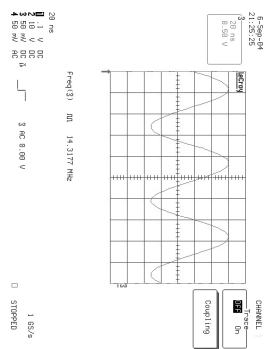

5. AUDIO CTL/AMP/RS232/TUNER

L3720RC
AUDIO CTL / AMP / RS232 / TUNER

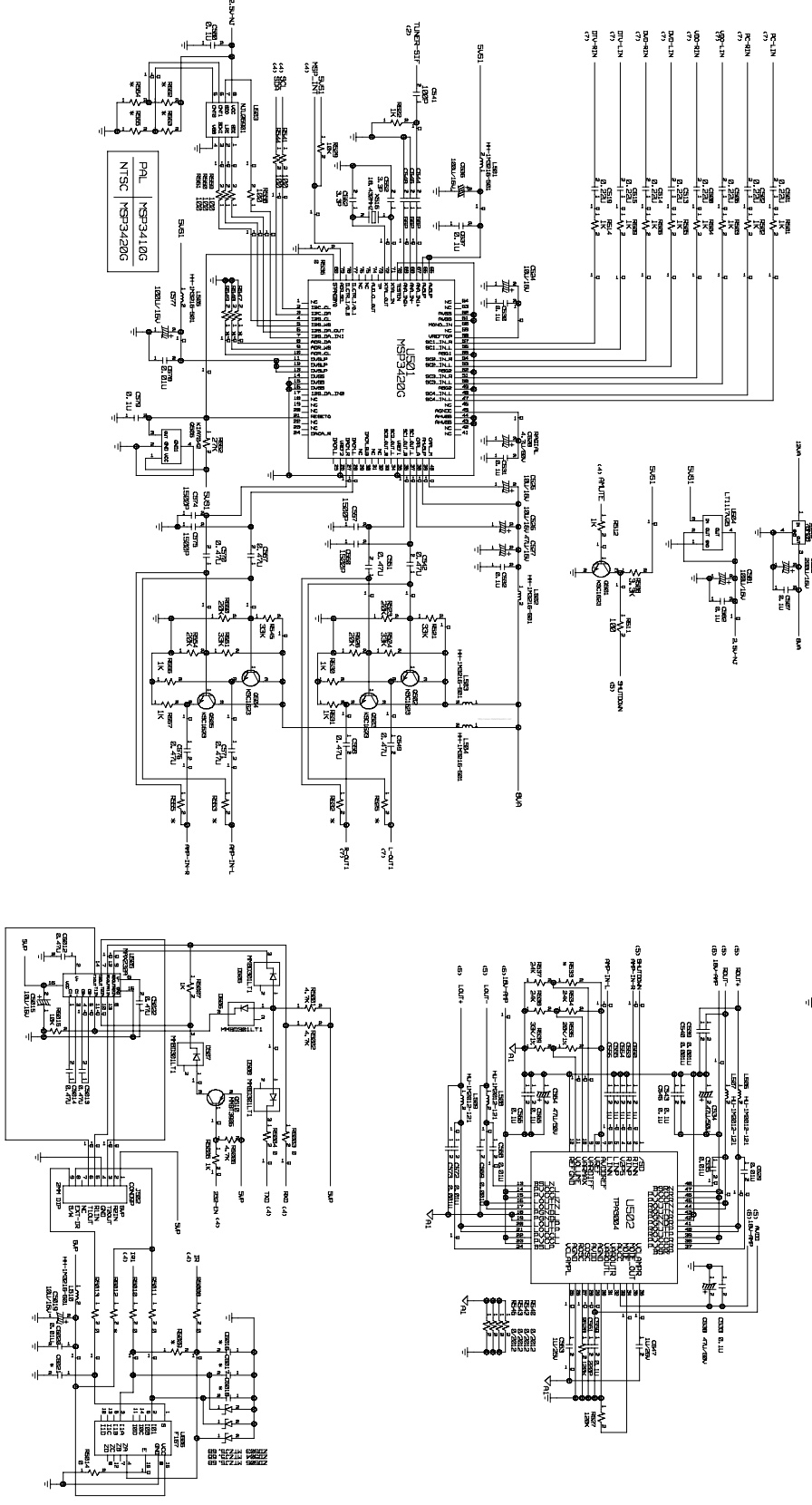

6. POWER/CONNECTOR

L3700AC POWER/CONNECTOR

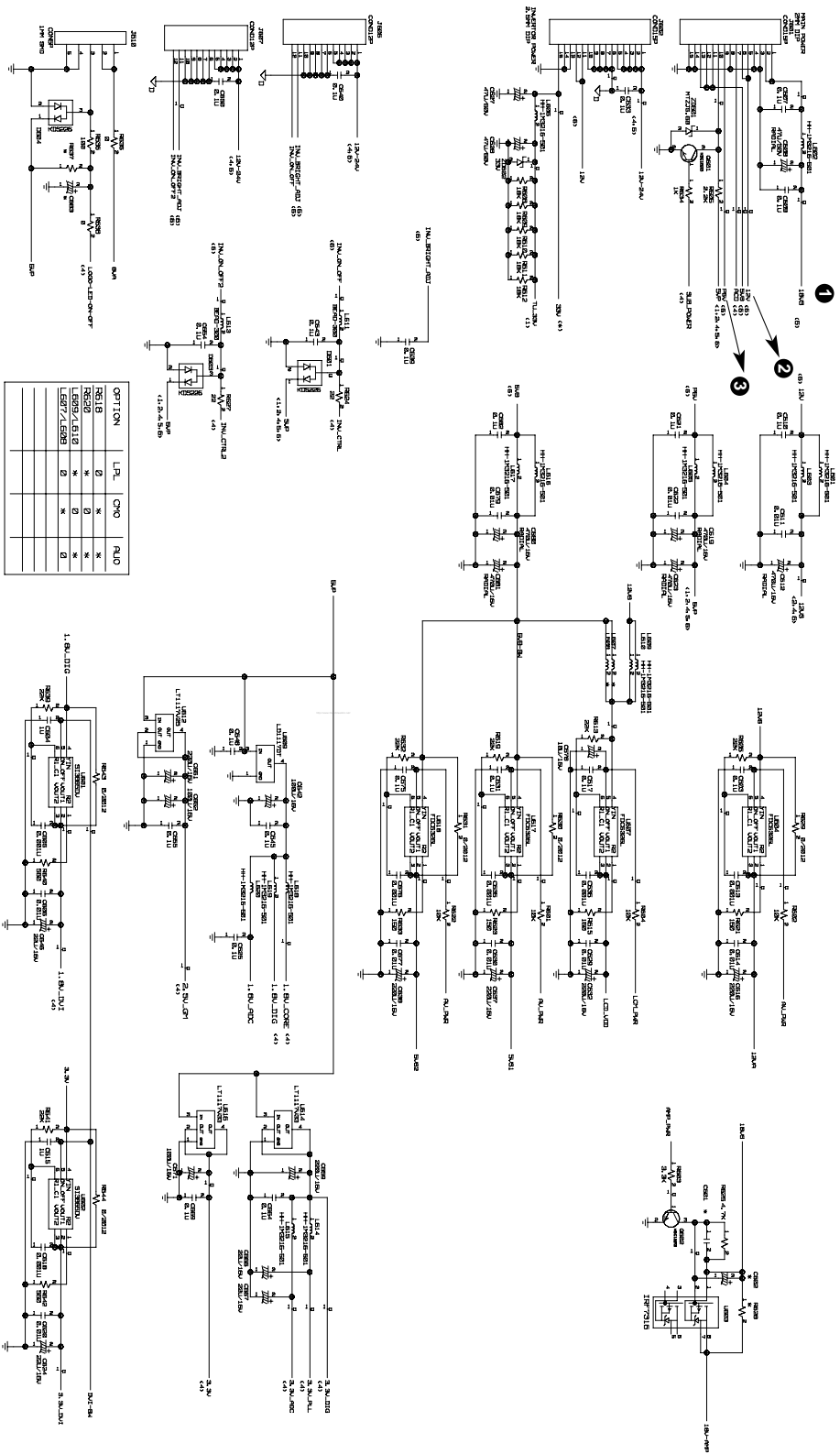

1 J601-18V

6-Sense-24
20 ne
5.0 V
1.8 V DC

PH1K(1) 1.20 V
PH2K(1) 1.180 V
PH3K(1) 1.150 V
PH13(1) 1.25 V

500 15.5

DC SW

2 J601-12V

6-Sense-24
21.04(5)
5.0 V
1.5 V DC

PH1K(1) 1.41 V
PH2K(1) 1.170 V
PH3K(1) 1.120 V
PH13(1) 1.24 V

500 15.5

DC SW

3 J601-5V

6-Sense-24
21.05(5)
2.00 V
1.1 V DC

PH1K(1) 1.50 V
PH2K(1) 6.412 V
PH3K(1) 5.814 V
PH13(1) 1.50 V

500 15.5

DC SW

6. POWER/CONNECTOR

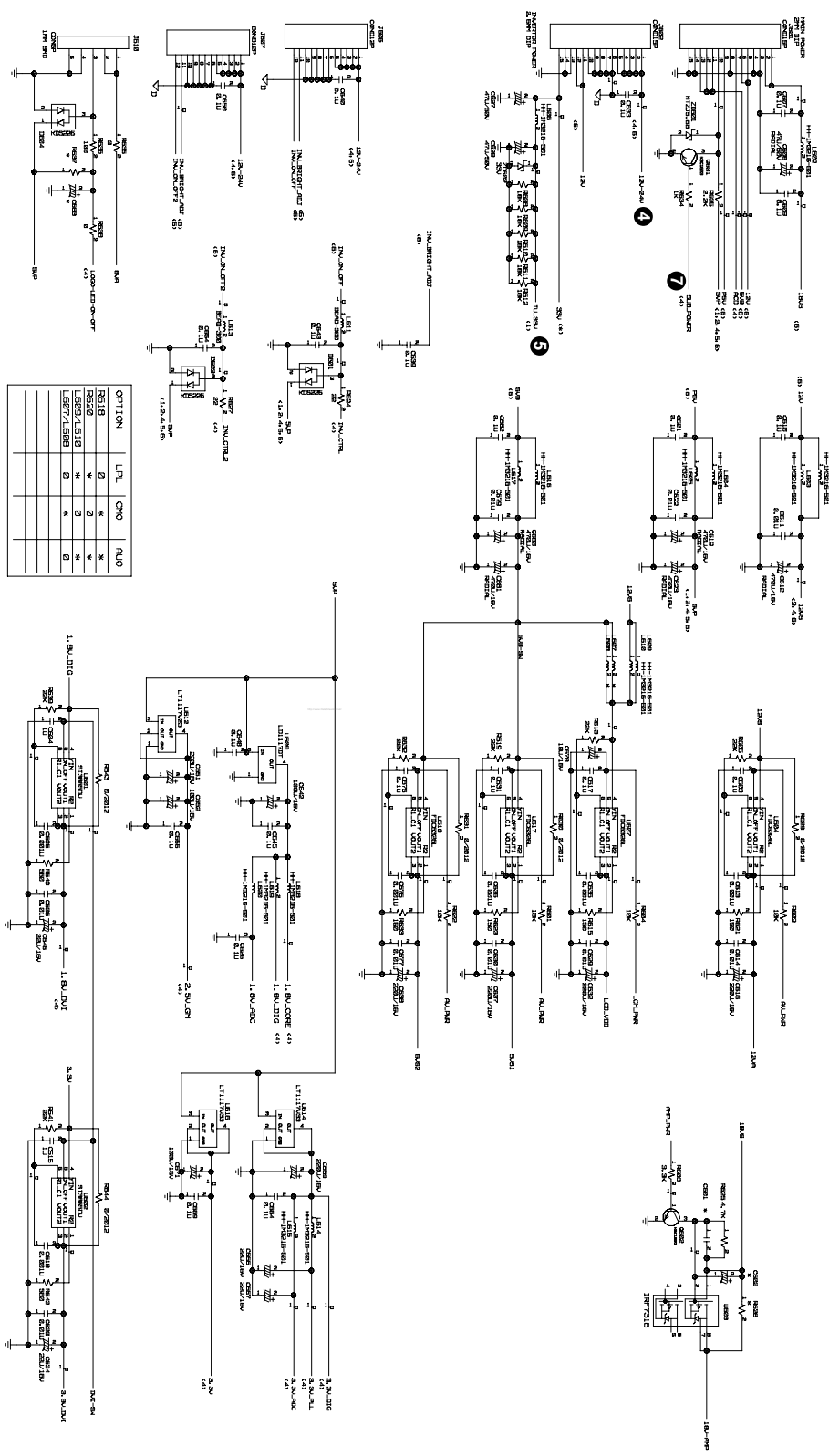

OPTION	LP	CMO	PAIO
R3C02	Q	V	V
R3C03	K	Q	K
L3B7 / L3B8	Q	K	Q

4 J602-24V

5-596-04
21.087.29
0.0 V

PH4(13) 0.84 V
PH4(12) 23.120 V
PH4(11) 23.875 V
PH4(10) 23.875 V
PH4(9) 18.000 V
PH4(8) 18.000 V
PH4(7) 18.000 V
PH4(6) 500.15/5

20 ns
1.5 V DC
50 mV DC

5 J602-33V

5-596-04
21.017.22
0.0 V

PH4(13) 2.5 V
PH4(12) 32.00 V
PH4(11) 32.210 V
PH4(10) 32.210 V
PH4(9) 18.000 V
PH4(8) 18.000 V
PH4(7) 18.000 V
PH4(6) 500.15/5

20 ns
1.5 V DC
50 mV DC

7 J601

5-596-04
21.283.12
1.00 V

PH4(13) 0.81 V
PH4(12) 2.000 V
PH4(11) 31V
PH4(10) 0.21 V
PH4(9) 18.000 V
PH4(8) 18.000 V
PH4(7) 18.000 V
PH4(6) 1.52/5

10 ns
1.5 V DC
50 mV DC

7. AV IN/OUT JACK

L3700AC
AV IN/OUT JACK

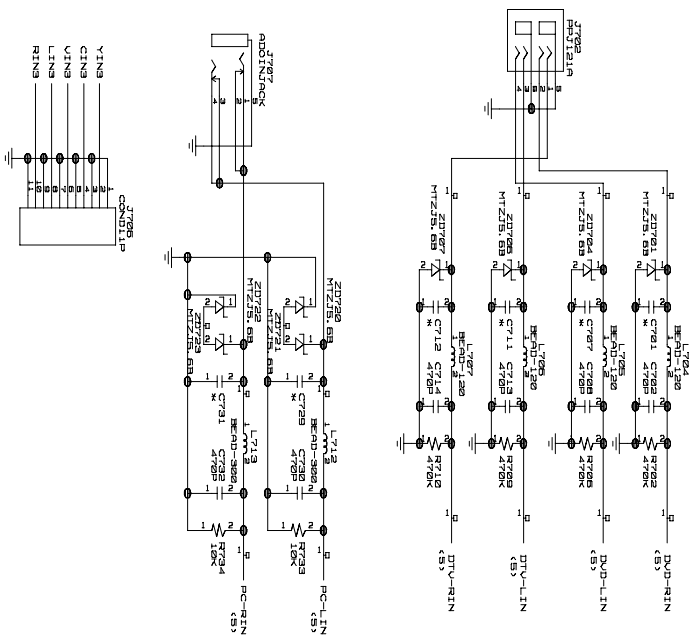
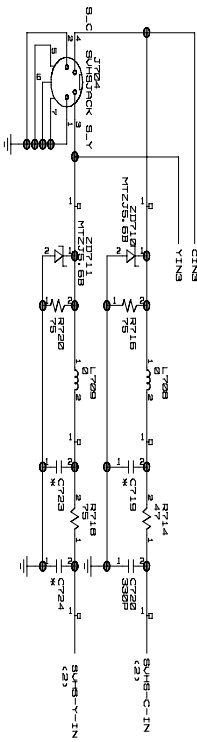
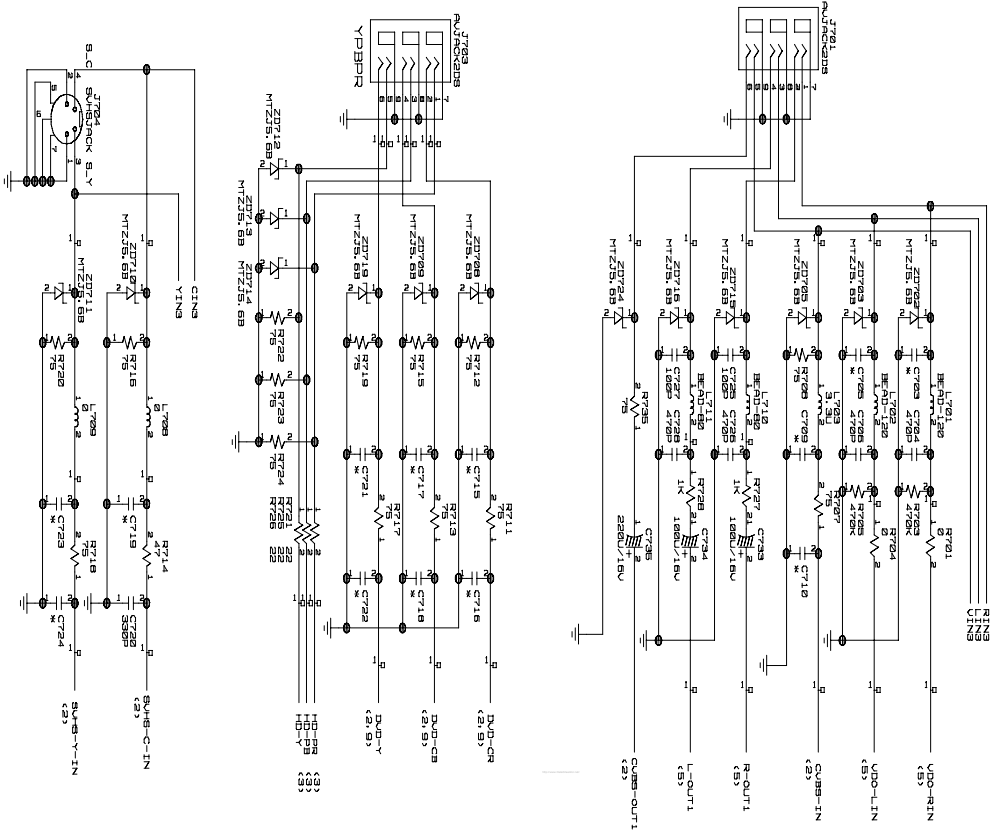

8. MDIN150/UPD64011A/MEMORY

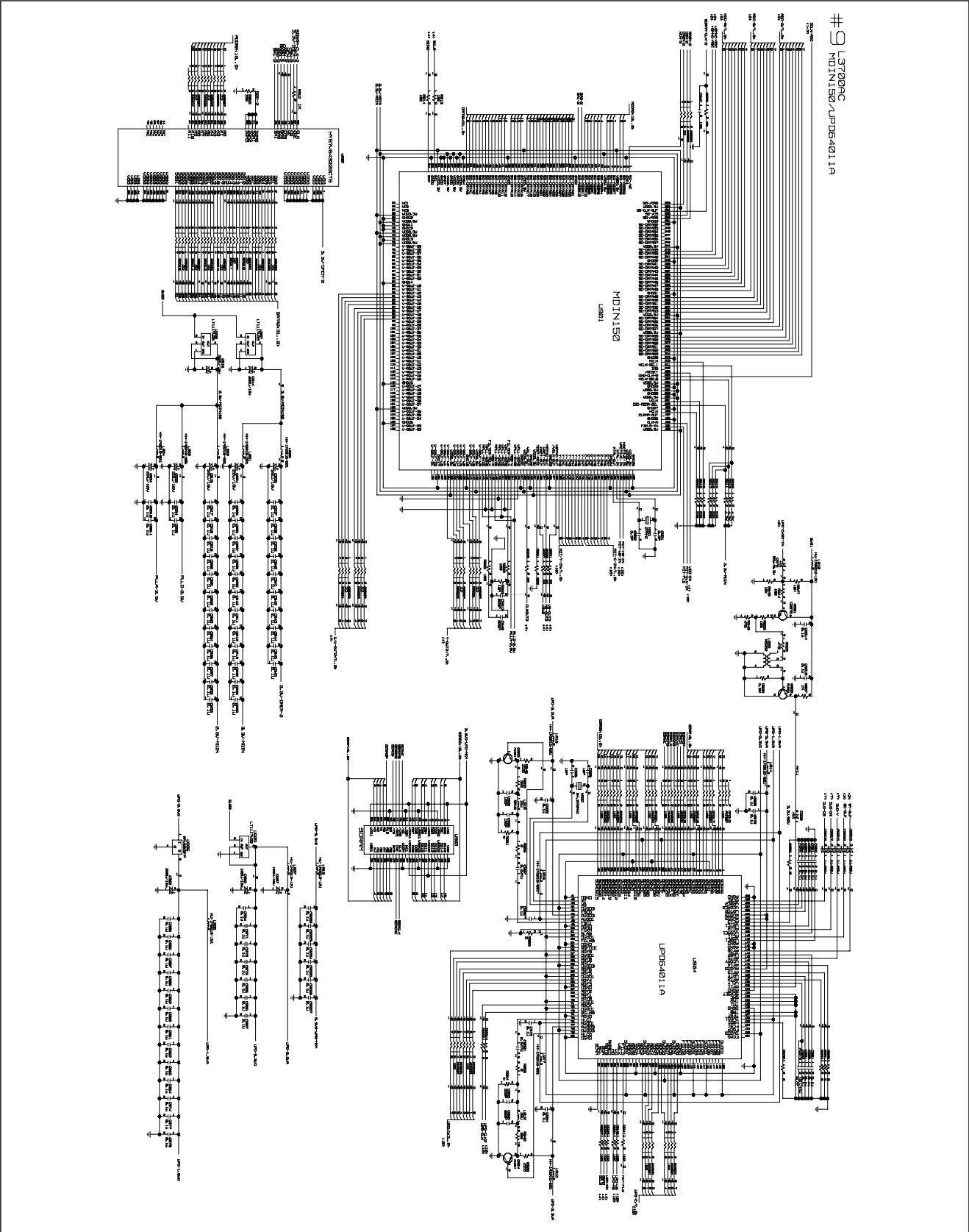

9. EX256/V-CHIP(M37272M6)

1  L3700AC
EX256/V-CHIP (M37272M6)

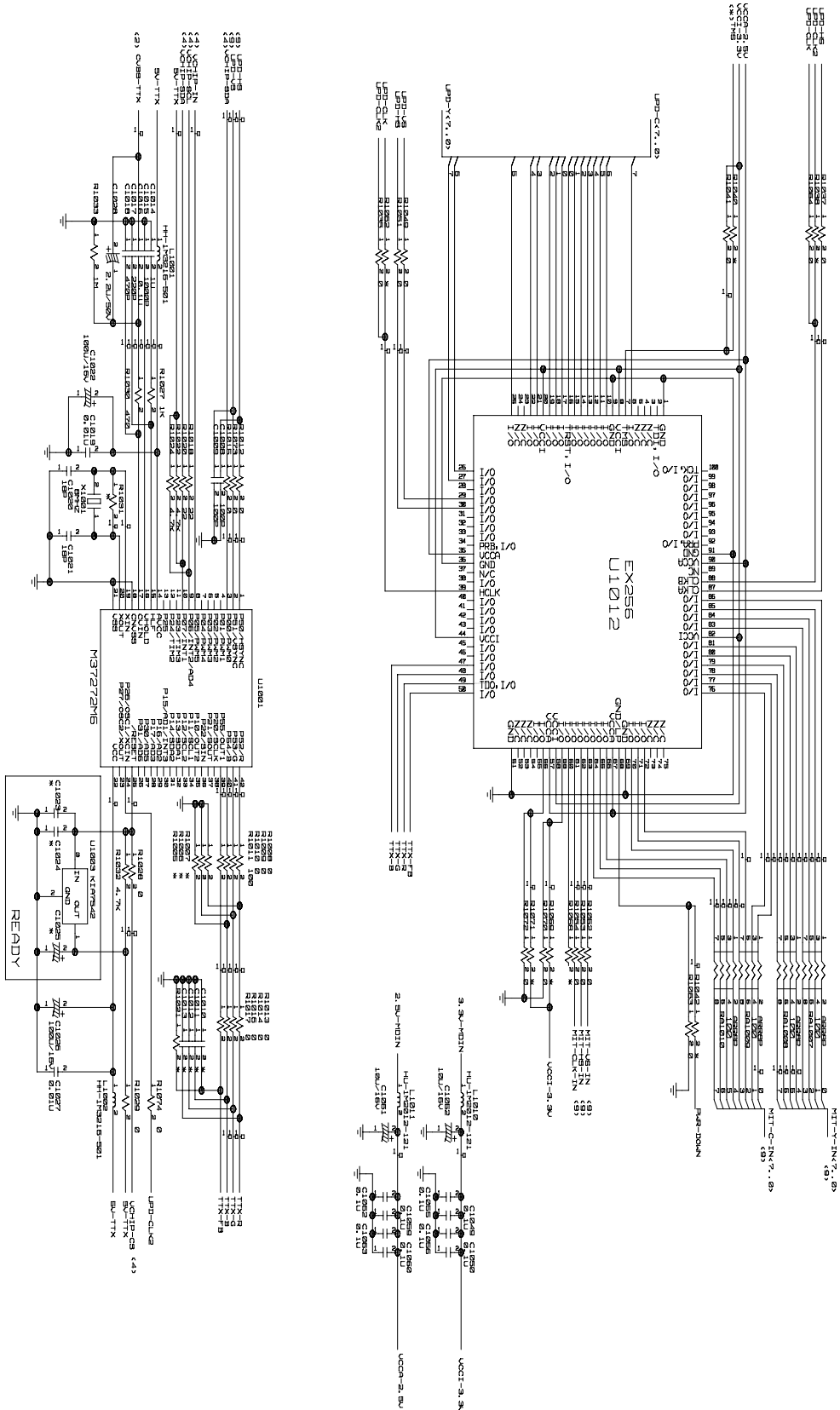



P/NO : 3828TSL093P

May. 2005
Printed in Korea