

Automotive 5 V low dropout voltage regulator

Datasheet - production data



- Very low consumption mode
- Precision output voltage 5 V +/- 2 %
- Thermal shutdown and short-circuit protection
- Wide temperature range ($T_j = -40\text{ }^{\circ}\text{C}$ to $150\text{ }^{\circ}\text{C}$)
- Enable input for enabling / disabling the voltage regulator

Description

L5300EPT is a low dropout linear regulator with ON/OFF control. In addition, only low value ceramic capacitor is required for stability (above or equal 220 nF).

Typical quiescent current is 55 μA in light load conditions. It drops to 5 μA in "not enabled" mode.

On-chip trimming results in high output voltage accuracy ($\pm 2\%$). Accuracy is kept over wide temperature range, line and load variations.

The maximum input voltage is 40 V. The max output current is internally limited. Internal temperature protection disables the voltage regulator output.

Features

Max DC supply voltage	V_S	40V
Max output voltage tolerance	ΔV_O	$\pm 2\%$
Max dropout voltage	V_{dp}	500 mV
Output current	I_o	300 mA
Quiescent current	I_{qn}	5 $\mu\text{A}^{(1)}$
		55 $\mu\text{A}^{(2)}$

1. Typical value with regulator disabled.
2. Typical value with regulator enabled.

- AEC-Q100 qualified
- Operating DC supply voltage range 5.6 V to 40 V
- Low dropout voltage
- 300 mA current capability
- Low quiescent current



Table 1. Device summary

Package	Order codes	
	Tube	Tape and reel
PPAK	L5300EPT	L5300EPTTR

Contents

- 1 Block diagram and pins description 5**

- 2 Electrical specifications 7**
 - 2.1 Absolute maximum ratings 7
 - 2.2 Thermal data 7
 - 2.3 Electrical characteristics 8
 - 2.4 Electrical characteristics curves 10

- 3 Application information 13**
 - 3.1 Voltage regulator 13
 - 3.2 Enable 15

- 4 Package and PCB thermal data 16**

- 5 Package and packing information 19**
 - 5.1 ECOPACK® 19
 - 5.2 PPAK mechanical data 20
 - 5.3 PPAK packing information 22

- 6 Revision history 23**

List of tables

Table 1.	Device summary	1
Table 2.	Pins description	6
Table 3.	Absolute maximum ratings	7
Table 4.	Thermal data	7
Table 5.	General	8
Table 6.	Enable.	9
Table 7.	PPAK thermal parameter	18
Table 8.	PPAK mechanical data	21
Table 9.	Document revision history	23

List of figures

Figure 1.	Block diagram	5
Figure 2.	Configuration diagram (top view)	5
Figure 3.	Output voltage vs T_j	10
Figure 4.	Output voltage vs V_S	10
Figure 5.	Output voltage vs V_{En}	10
Figure 6.	Drop voltage vs output current	10
Figure 7.	Current consumption vs output current	10
Figure 8.	Current consumption vs output current (at light load condition)	10
Figure 9.	Current consumption vs input voltage ($I_o = 0.1$ mA)	11
Figure 10.	Current consumption vs input voltage ($I_o = 100$ mA)	11
Figure 11.	Current limitation vs T_j	11
Figure 12.	Current limitation vs input voltage	11
Figure 13.	Short-circuit current vs T_j	11
Figure 14.	Short-circuit current vs input voltage	11
Figure 15.	V_{En_high} vs T_j	12
Figure 16.	V_{En_low} vs T_j	12
Figure 17.	Application schematic	13
Figure 18.	Stability region	14
Figure 19.	Maximum load variation response	14
Figure 20.	PPAK PC board	16
Figure 21.	R_{thj_amb} vs PCB copper area in open box free air condition	16
Figure 22.	PPAK thermal impedance junction ambient single pulse	17
Figure 23.	Thermal fitting model of a Vreg in PPAK	17
Figure 24.	PPAK dimension	20
Figure 25.	PPAK suggested pad layout and tube shipment (no suffix)	22
Figure 26.	PPAK tape and reel shipment (suffix "TR")	22

1 Block diagram and pins description

Figure 1. Block diagram

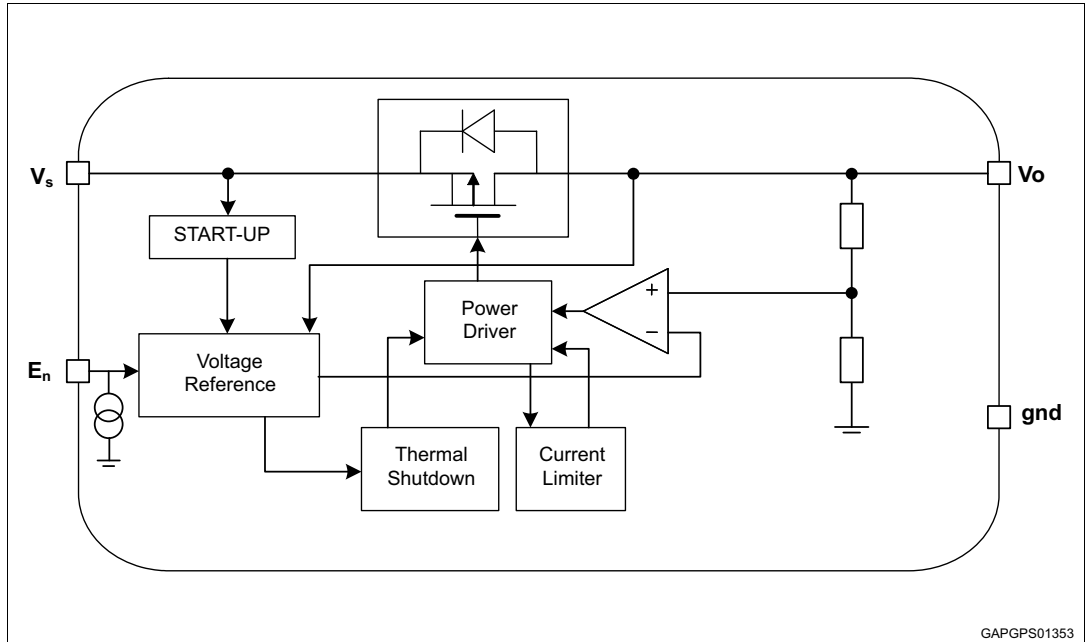

Figure 2. Configuration diagram (top view)

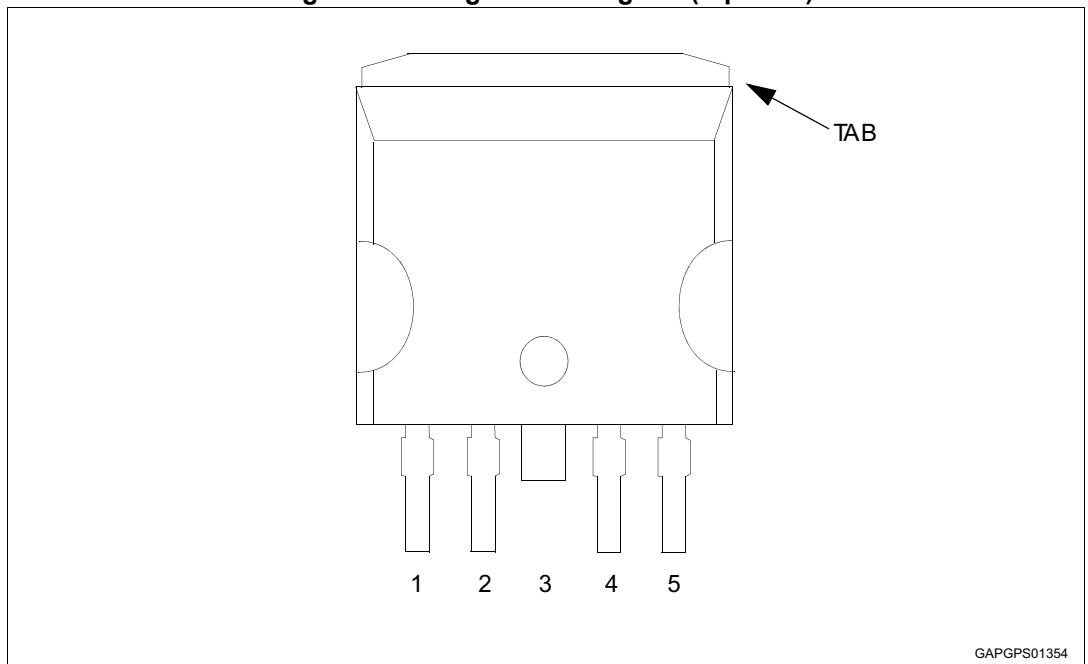

Table 2. Pins description

N°	Name	Function
1	V_S	Supply voltage, block directly to GND on the IC with a capacitor.
2	E_n	Enable input. A high signal switches the regulator on. Connect to V_S if not needed.
3	GND	Ground is internally electrically connected to TAB.
4	N_c	Not connected
5	V_o	5 V regulated output. Block to GND with a ceramic capacitor (≥ 220 nF for regulator stability).

2 Electrical specifications

2.1 Absolute maximum ratings

Stressing the device above the rating listed in the [Table 3: Absolute maximum ratings](#) may cause permanent damage to the device. These are stress ratings only and operation of the device at these or any other conditions above those indicated in the operating sections of this specification is not implied. Exposure to absolute maximum rating conditions for extended periods may affect device reliability. Refer also to the STMicroelectronics SURE program and other relevant quality documents.

Table 3. Absolute maximum ratings

Symbol	Parameter	Value	Unit
V_{sdc}	DC supply voltage	-0.3 to 40	V
I_{sdc}	Input current	Internally limited	
V_{odc}	DC output voltage	-0.3 to 6	V
I_{odc}	DC output current	Internally limited	
V_{En}	Enable input	-0.3 to 40	V
T_j	Junction temperature	-40 to 150	°C
$V_{ESD\ HBM}$	ESD HBM voltage level (HBM-MIL STD 883C)	+/- 2	kV
$V_{ESD\ CDM}$	ESD CDM voltage level (CDM- AEC-Q100-011)	+/- 750	V

2.2 Thermal data

Table 4. Thermal data

Symbol	Parameter	Value	Unit
$R_{thj-case}$	Thermal resistance junction to case	5	°C/W
$R_{thj-amb}$	Thermal resistance junction to ambient	45.5	°C/W

2.3 Electrical characteristics

Values specified in this section are for $V_S = 5.6\text{ V to }31\text{ V}$, $T_j = -40\text{ °C to }+150\text{ °C}$ unless otherwise stated.

Table 5. General

Pin	Symbol	Parameter	Test condition	Min.	Typ.	Max.	Unit
V_o	V_{o_ref}	Output voltage	$V_S = 8\text{ V to }18\text{ V}$ $I_o = 8\text{ mA to }300\text{ mA}$	4.9	5.0	5.1	V
V_o	V_{o_ref}	Output voltage	$V_S = 5.6\text{ V to }31\text{ V}$ $I_o = 8\text{ mA to }300\text{ mA}$	4.85	5.0	5.15	V
V_o	V_{o_ref}	Output voltage	$V_S = 5.6\text{ V to }31\text{ V}$ $I_o = 0.1\text{ mA to }8\text{ mA}$	4.75	5.0	5.25	V
V_o	I_{short}	Short-circuit current	$V_S = 13.5\text{ V}$	0.8	1.8	2.6	A
V_o	I_{lim}	Output current capability ⁽¹⁾	$V_S = 13.5\text{ V}$	0.6	1.6	2.5	A
V_S, V_o	V_{line}	Line regulation voltage	$V_S = 6\text{ V to }28\text{ V}$ $I_o = 50\text{ mA}$			40	mV
V_o	V_{load}	Load regulation voltage	$V_S = 13.5\text{ V}$ $I_o = 8\text{ mA to }300\text{ mA}$ $T_j = 25\text{ °C}$			40	mV
			$V_S = 8\text{ V to }18\text{ V}$ $I_o = 8\text{ mA to }300\text{ mA}$			55	
V_S, V_o	V_{dp}	Drop voltage ⁽²⁾	$I_o = 300\text{ mA}$			500	mV
V_S, V_o	SVR	Ripple rejection	$f_r = 100\text{ Hz}$ ⁽³⁾		60		dB
V_o	I_{oth_H}	Normal consumption mode output current	$V_S = 8\text{ V to }18\text{ V}$	8			mA
V_o	I_{oth_L}	Very low consumption mode output current	$V_S = 8\text{ V to }18\text{ V}$			1.1	mA
V_o	I_{oth_Hyst}	Output current switching threshold hysteresis	$V_S = 13.5\text{ V}; T_j = 25\text{ °C}$		0.8		mA
V_S, V_o	I_{qs}	Current consumption with regulator disabled $I_{qs} = I_{V_S} - I_o$	$V_S = 13.5\text{ V}; E_n = \text{low}$		5	10	μA
V_S, V_o	I_{qn_1}	Current consumption with regulator enabled $I_{qn_1} = I_{V_S} - I_o$	$V_S = 13.5\text{ V},$ $I_o = 0.1\text{ mA to }1\text{ mA},$ $E_n = \text{high}$		55	80	μA
V_S, V_o	I_{qn_300}	Current consumption with regulator enabled $I_{qn_300} = I_{V_S} - I_o$	$V_S = 13.5\text{ V}, I_o = 300\text{ mA},$ $E_n = \text{high}$		3	4.2	mA
	T_w	Thermal protection temperature		150		190	$^{\circ}\text{C}$
	T_{w_hy}	Thermal protection temperature hysteresis			10		$^{\circ}\text{C}$

1. Measured output current when the output voltage has dropped 100 mV from its nominal value obtained at 13.5 V and $I_o = 75\text{ mA}$.

2. $V_S - V_O$ measured dropout when the output voltage has dropped 100 mV from its nominal value obtained at 13.5V and $I_O = 75$ mA.
3. Guaranteed by design.

Table 6. Enable

Pin	Symbol	Parameter	Test condition	Min.	Typ.	Max.	Unit
E_n	$V_{E_n_low}$	E_n input low voltage				1	V
E_n	$V_{E_n_high}$	E_n input high voltage		3			V
E_n	$V_{E_n_hyst}$	E_n input hysteresis			500		mV
E_n	I_{leak}	Pull down current	$V_{E_n} = 5$ V		3	10	μ A

2.4 Electrical characteristics curves

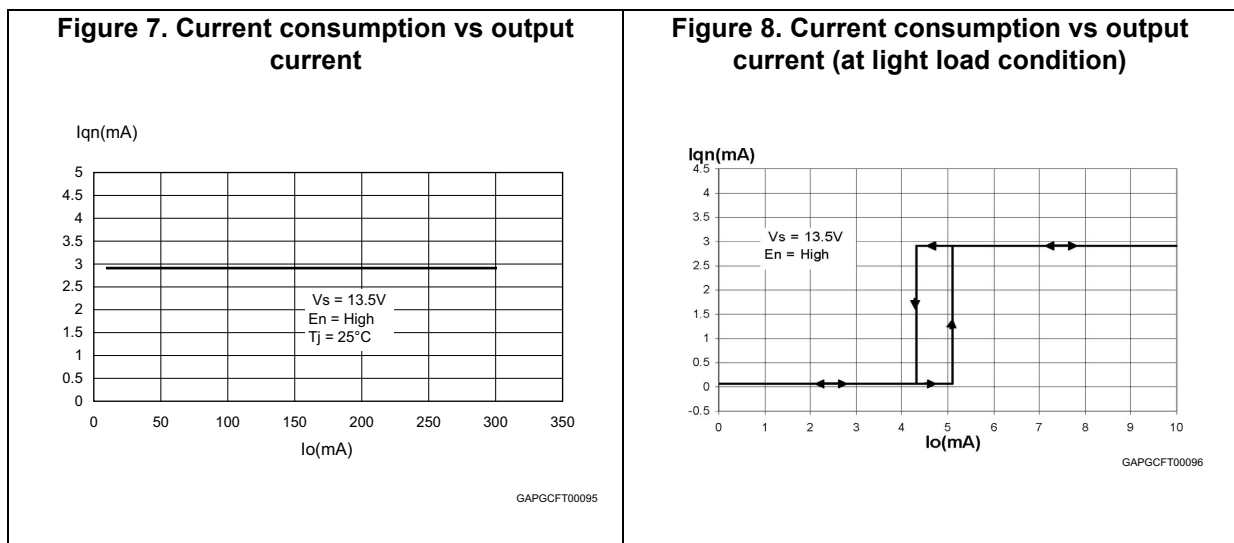
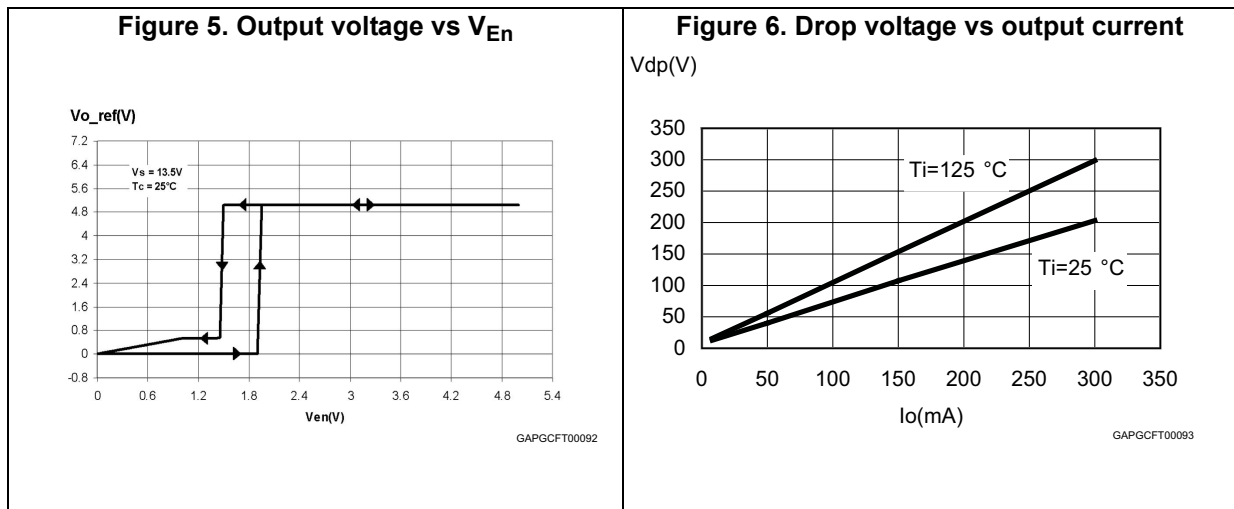
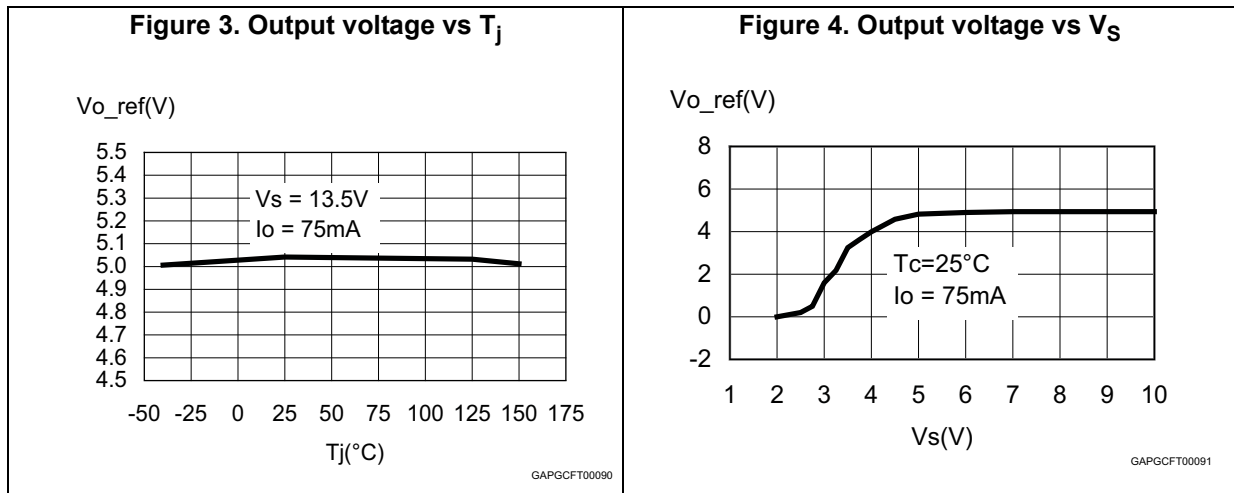
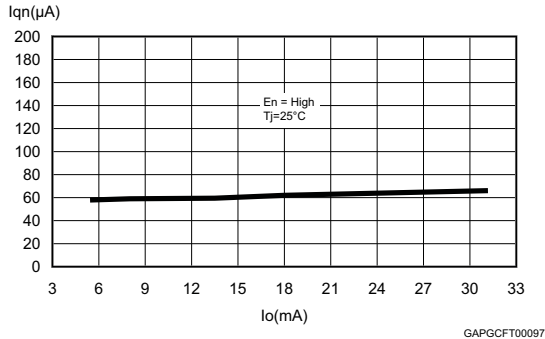
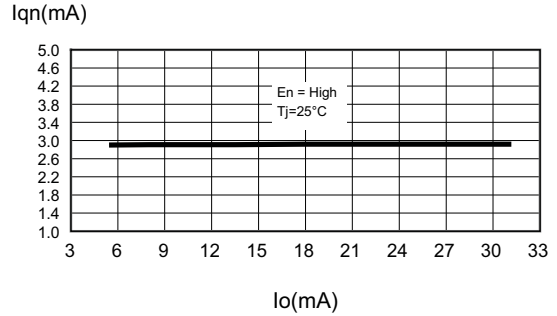

Figure 9. Current consumption vs input voltage ($I_o = 0.1 \text{ mA}$)



GAPGCF00097

Figure 10. Current consumption vs input voltage ($I_o = 100 \text{ mA}$)



GAPGCF00098

Figure 11. Current limitation vs T_j

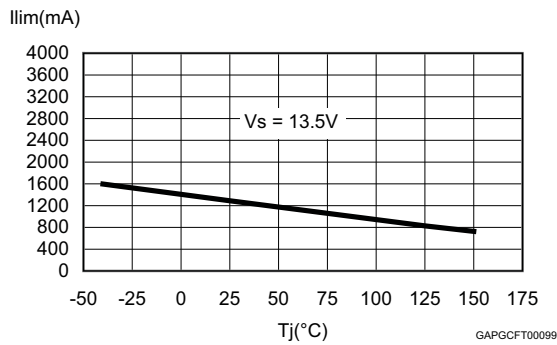

GAPGCF00099

Figure 12. Current limitation vs input voltage

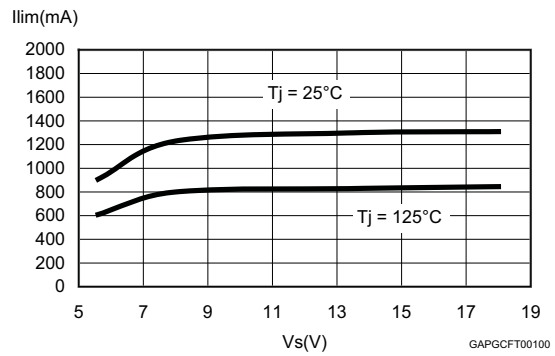

GAPGCF00100

Figure 13. Short-circuit current vs T_j

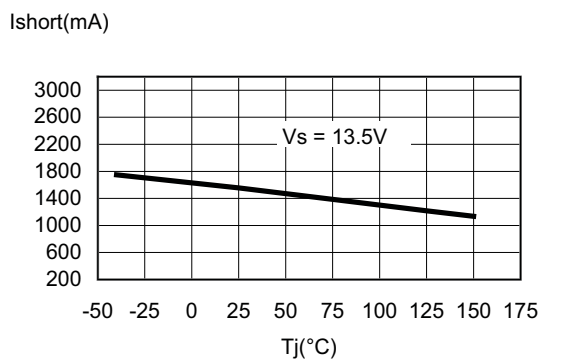

GAPGCF00101

Figure 14. Short-circuit current vs input voltage

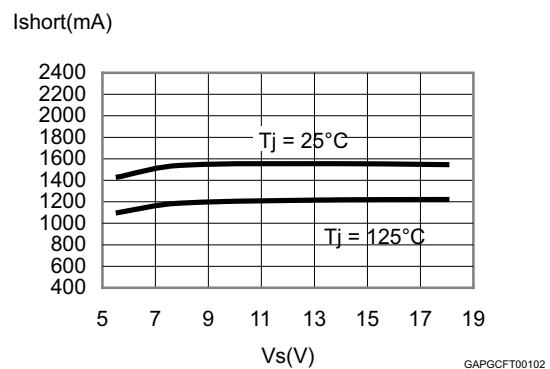

GAPGCF00102

Figure 15. V_{En_high} vs T_j

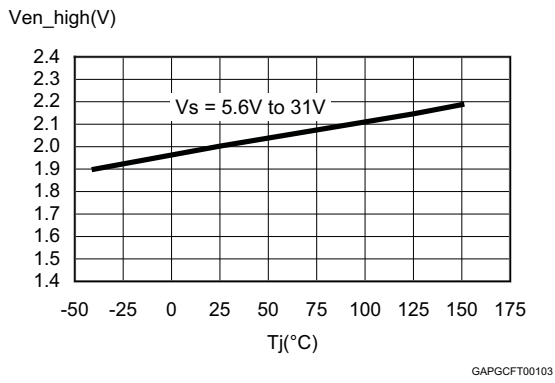
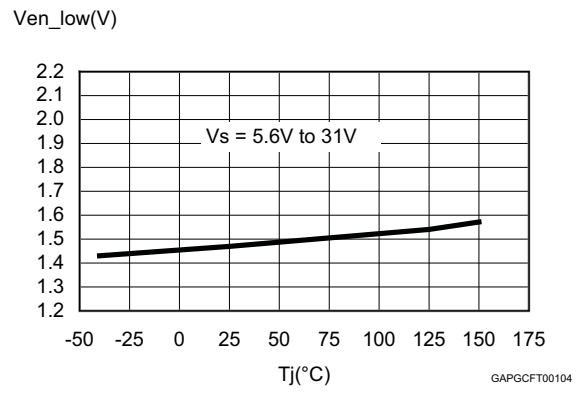

Figure 16. V_{En_low} vs T_j



3 Application information

3.1 Voltage regulator

The voltage regulator uses a p-channel mos transistor as a regulating element. With this structure a very low dropout voltage at current up to 300 mA is obtained. The output voltage is regulated up to input supply voltage of 40 V. The high-precision of the output voltage ($\pm 2\%$) is obtained with a pre-trimmed reference voltage. The voltage regulator automatically adapts its own quiescent current to the output current level. In light load conditions the quiescent current goes down to 55 μA only (low consumption mode). This procedure features a certain hysteresis on the output current (see [Figure 8](#)). Short-circuit protection to GND and a thermal shutdown are provided.

Figure 17. Application schematic

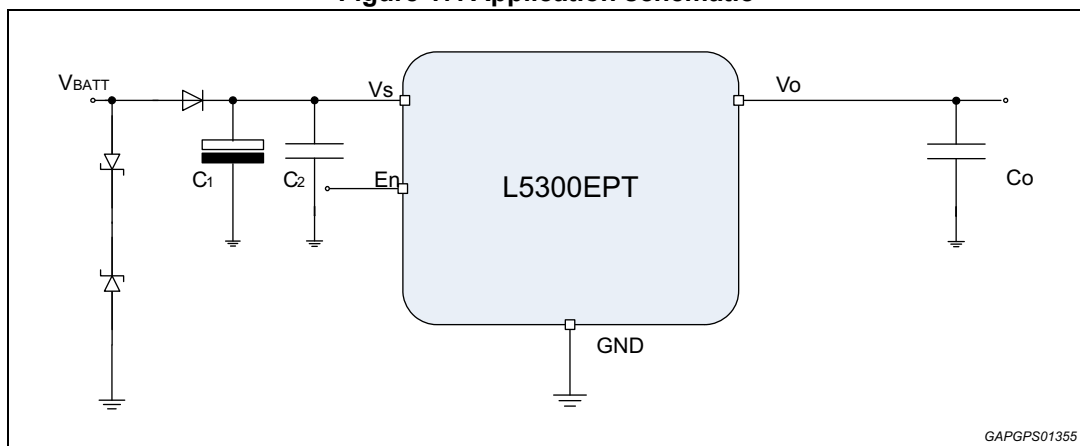

The input capacitor $C_1 \geq 100 \mu\text{F}$ is necessary as backup supply for negative pulses which may occur on the line. The second input capacitor $C_2 \geq 220 \text{ nF}$ is needed when the C_1 is too distant from the V_S pin and it compensates smooth line disturbances. The C_0 ceramic capacitor, connected to the output pin, is for bypassing to GND the high-frequency noise and it guarantees stability even during sudden line and load variations. Suggested value is $C_0 = 220 \text{ nF}$ with $\text{ESR} \geq 100 \text{ m}\Omega$.

Stability region is reported in [Figure 18](#).

Figure 18. Stability region

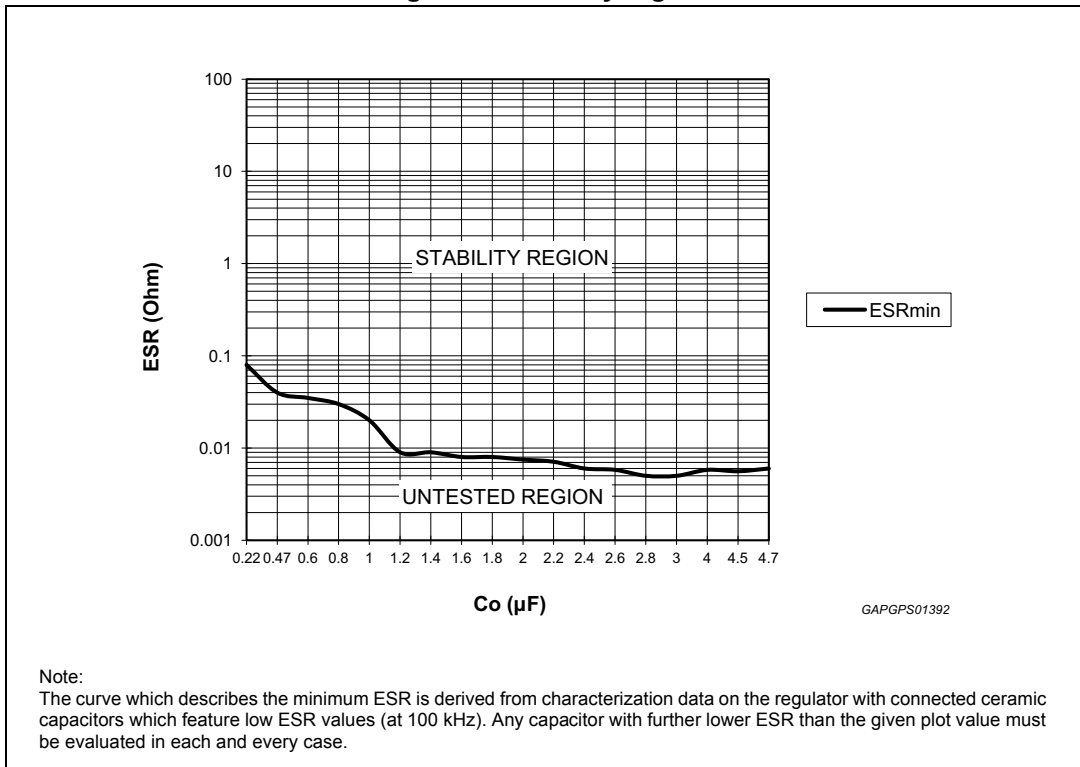
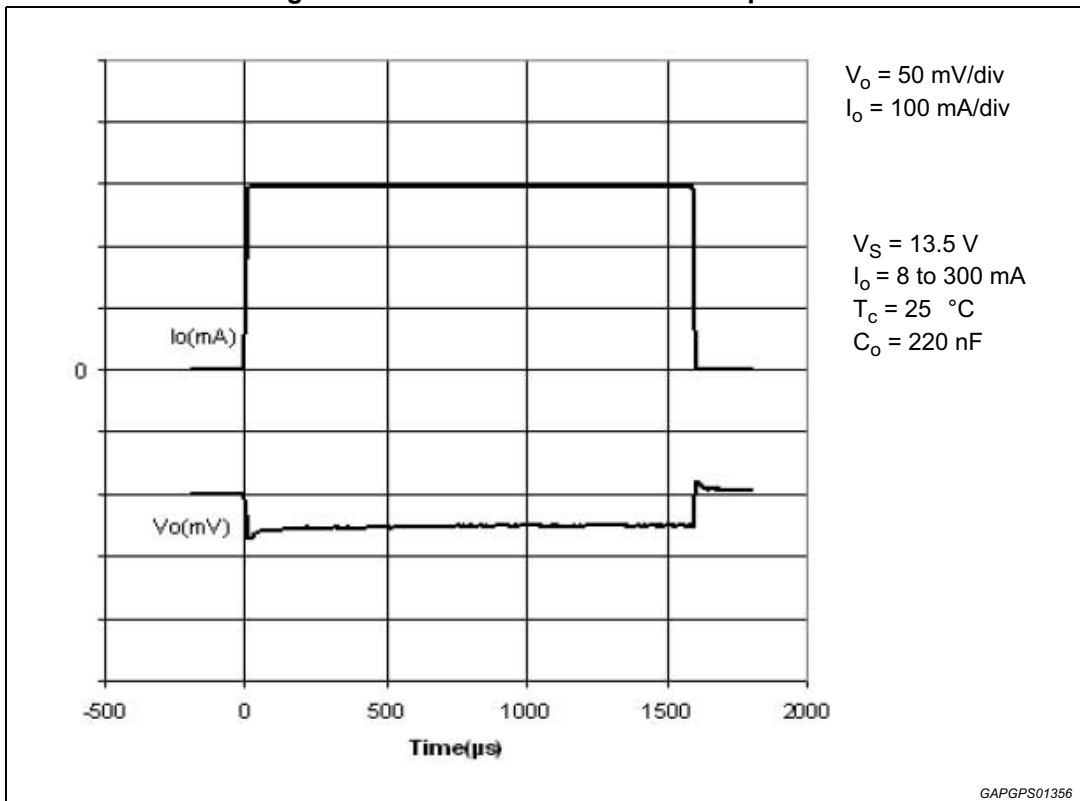

Figure 19. Maximum load variation response



3.2 Enable

L5300EPT is also provided by an enable input, a high signal switches the regulator on. In stand by mode the output is disabled and the current consumption of the device (quiescent current) is less than 10 μA .

4 Package and PCB thermal data

Figure 20. PPAK PC board

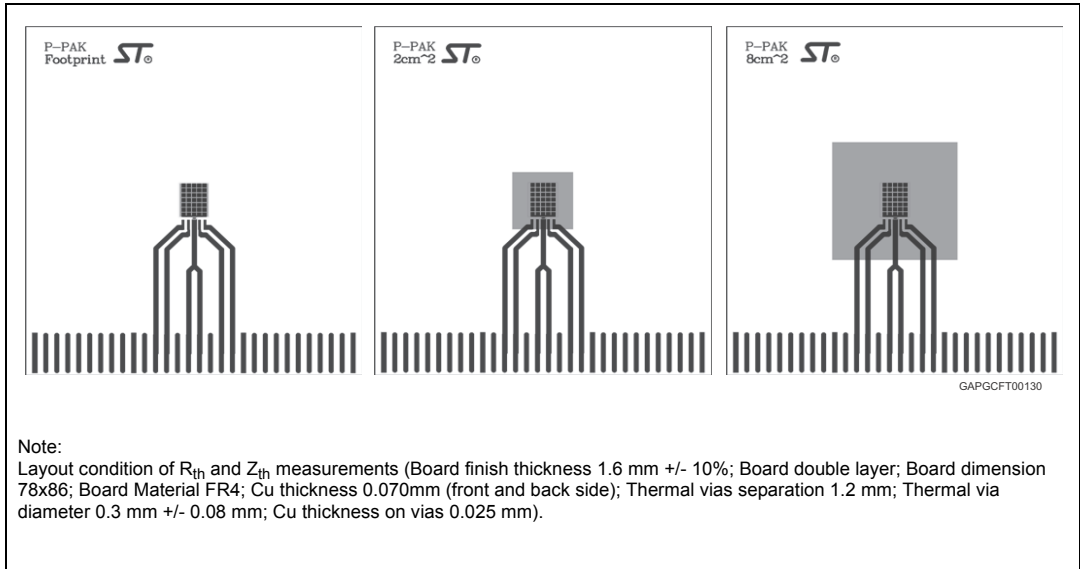

Figure 21. $R_{thj-amb}$ vs PCB copper area in open box free air condition

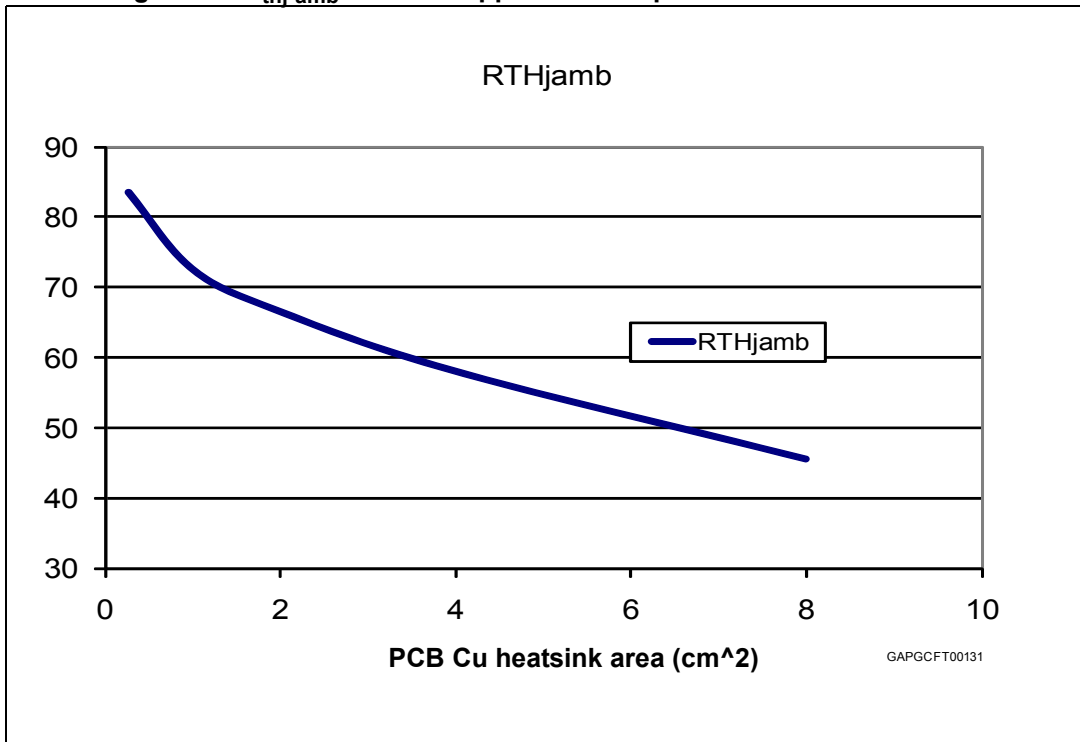
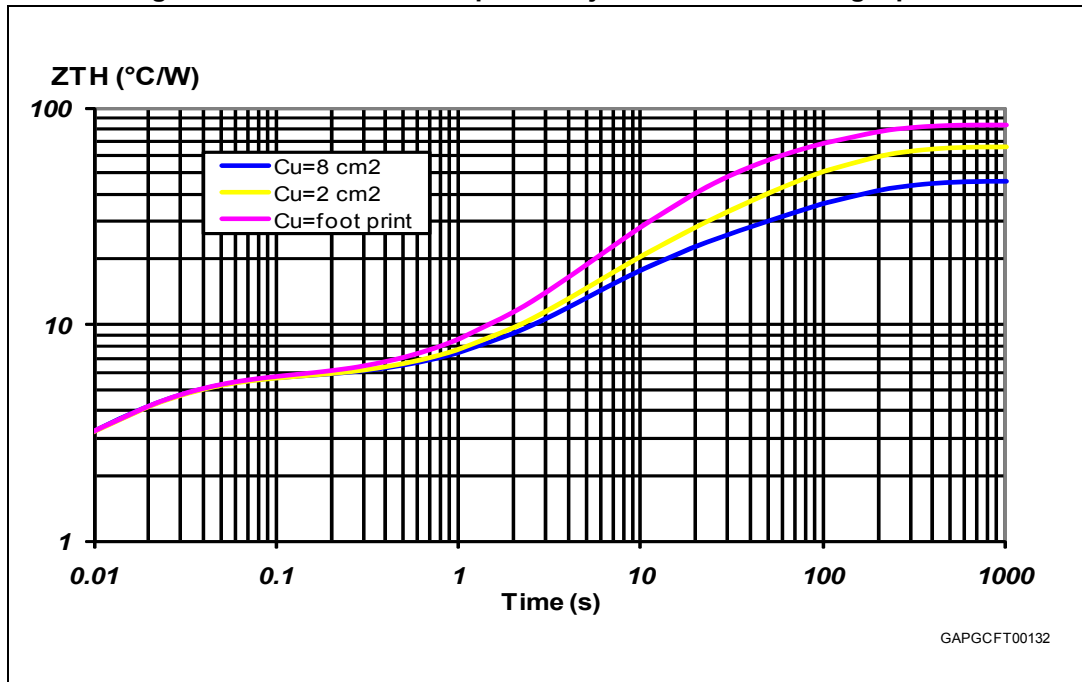

Figure 22. PPAK thermal impedance junction ambient single pulse



Equation 1: pulse calculation formula

$$Z_{TH\delta} = R_{TH} \cdot \delta + Z_{THtp}(1 - \delta)$$

where $\delta = t_p/T$

Figure 23. Thermal fitting model of a Vreg in PPAK

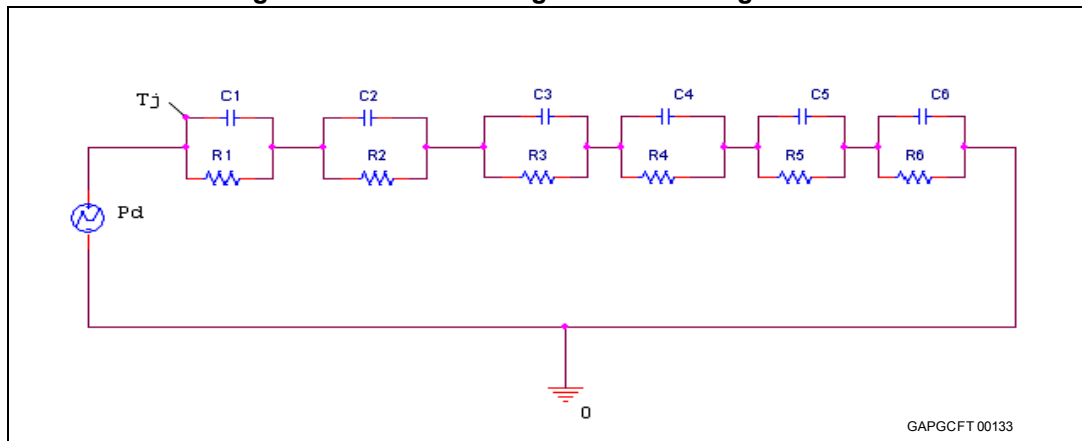

Table 7. PPAK thermal parameter

Area (cm ²)	Footprint	2	8
R1 (°C/W)	1.2		
R2 (°C/W)	6		
R3 (°C/W)	7		
R4 (°C/W)	10	10	9
R5 (°C/W)	22	15	10
R6 (°C/W)	26	20	15
C1 (W.s/°C)	0.0008		
C2 (W.s/°C)	0.0016		
C3 (W.s/°C)	0.05		
C4 (W.s/°C)	0.2	0.1	0.1
C5 (W.s/°C)	0.27	0.8	1
C6 (W.s/°C)	3	6	9

5 Package and packing information

5.1 ECOPACK®

In order to meet environmental requirements, ST offers these devices in different grades of ECOPACK® packages, depending on their level of environmental compliance. ECOPACK® specifications, grade definitions and product status are available at: www.st.com. ECOPACK® is an ST trademark.

5.2 PPAK mechanical data

Figure 24. PPAK dimension

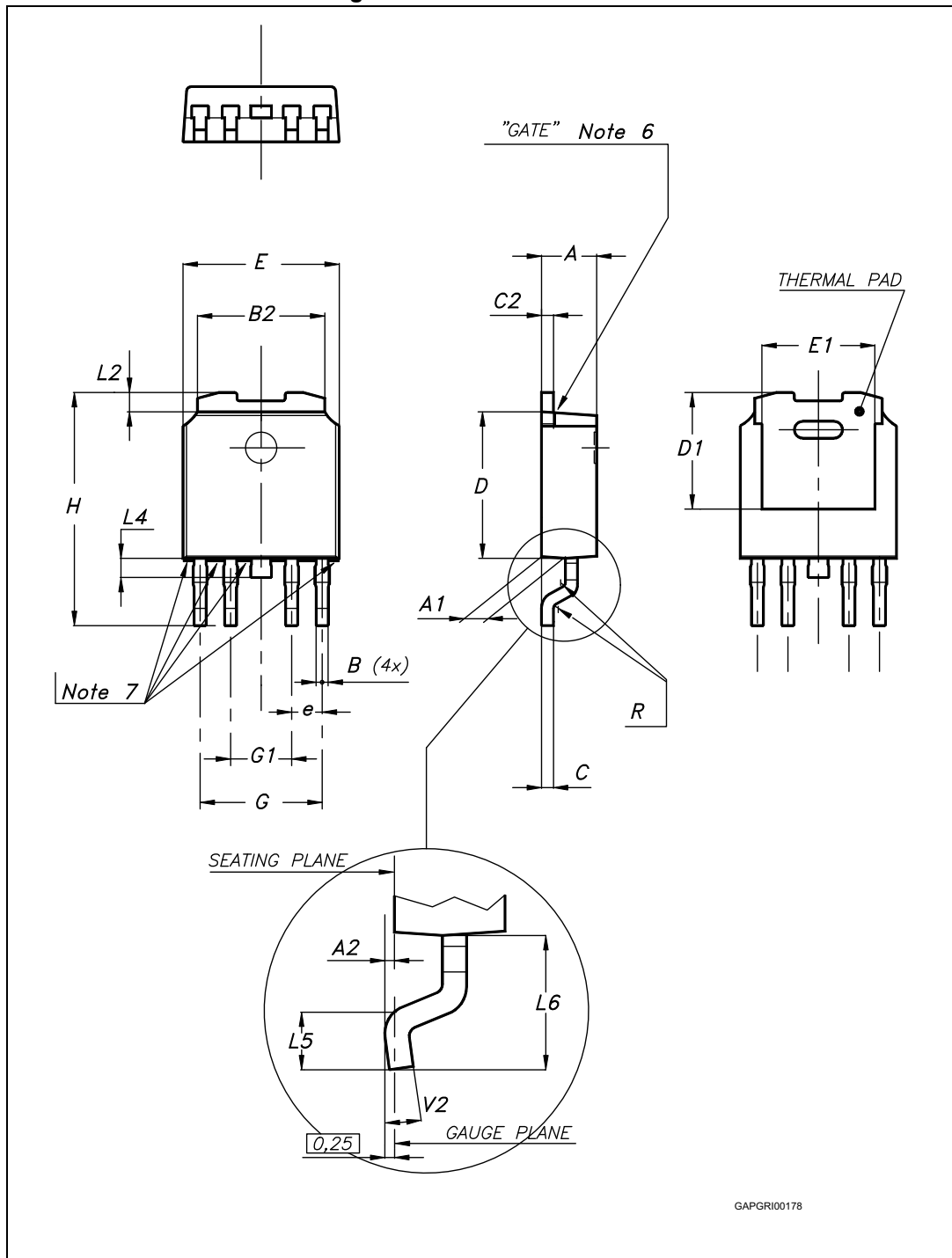
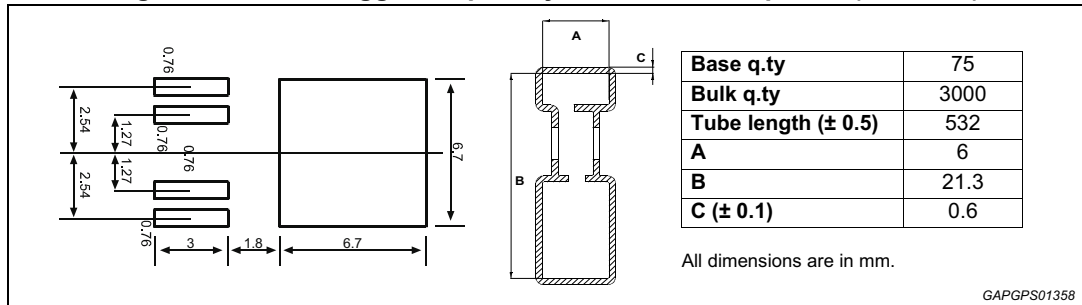

Table 8. PPAK mechanical data

Symbol	Millimeters		
	Min.	Typ.	Max.
A	2.20		2.40
A1	0.90		1.10
A2	0.03		0.23
B	0.40		0.60
B2	5.20		5.40
C	0.45		0.60
C2	0.48		0.60
D1		5.1	
D	6.00		6.20
E	6.40		6.60
E1		4.7	
e		1.27	
G	4.90		5.25
G1	2.38		2.70
H	9.35		10.10
L2		0.8	1.00
L4	0.60		1.00
L5	1.00		
L6		2.80	
R		0.2	
V2	0°		8°
Package weight	Gr. 0.3		

5.3 PPAK packing information

Figure 25. PPAK suggested pad layout and tube shipment (no suffix)



GAPGPS01358

Figure 26. PPAK tape and reel shipment (suffix “TR”)

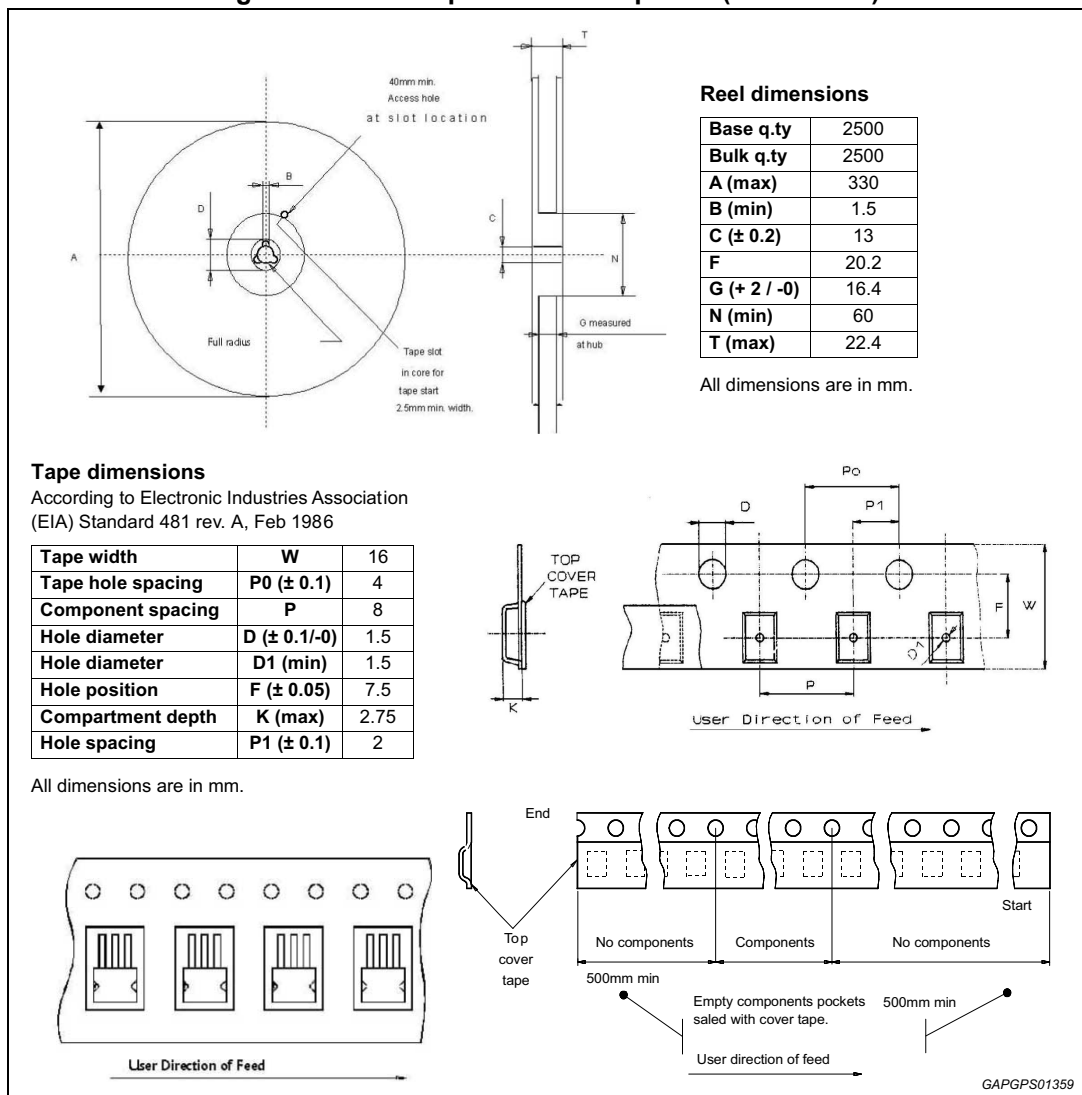

GAPGPS01359

6 Revision history

Table 9. Document revision history

Date	Revision	Changes
12-Jul-2007	1	Initial release.
13-Mar-2009	2	<p>Changed features table on the cover page</p> <p>Table 5: General</p> <ul style="list-style-type: none"> – V_{o_ref}: deleted row and added 3 new rows <p>Updated Table 6: Enable</p>
20-Sep-2010	3	<p>Updated corporate template from V2 to V3</p> <p>Changed the title of the document</p> <p>Features in cover page</p> <p>Changed typical quiescent current value from 60 μA to 55 μA</p> <p>Description in cover page</p> <ul style="list-style-type: none"> – Changed typical quiescent current value from 60 μA to 55 μA – Changed dropped current value from 10 μA to 5 μA <p>Table 2: Pins description</p> <ul style="list-style-type: none"> – Updated pins sequence <p>Table 3: Absolute maximum ratings</p> <ul style="list-style-type: none"> – I_{SDC}: changed symbol from I_{VSDC} – I_{ODC}: changed symbol from I_{VODC} – V_{ESD_CDM}: added standard for parameter <p>Updated Table 4: Thermal data</p> <p>Table 5: General</p> <ul style="list-style-type: none"> – I_{short}: changed min/typ/max value – I_{lim}: changed min/typ/max value, changed parameter – V_{line}: changed test condition – V_{load}: changed test condition, added new spec. – SVR: deleted min value, added typ value – I_{qn_300}: changed typ/max value – I_{oth_H}, I_{oth_L}, I_{oth_Hyst}: added new rows – Updated all tablefootnote <p>Table 6: Enable</p> <ul style="list-style-type: none"> – I_{leak}: changed typ value <p>Deleted Figure 3: Behavior of output current versus regulated voltage V_o</p> <p>Added Section 2.4: Electrical characteristics curves</p> <p>Added Chapter 4: Package and PCB thermal data</p>
12-Oct-2010	4	Updated Section 3.1: Voltage regulator
27-Jan-2012	5	Updated Figure 18: Stability region on page 14 .
07-Feb-2012	6	Modified Figure 18: Stability region on page 14
04-May-2012	7	Updated Figure 24: PPAK dimension on page 20 and Table 8: PPAK mechanical data
19-Sep-2013	8	Updated disclaimer.
25-Sep-2018	9	Updated title and added the feature “AEC-Q100 qualified” in cover page with automotive logo.

IMPORTANT NOTICE – PLEASE READ CAREFULLY

STMicroelectronics NV and its subsidiaries ("ST") reserve the right to make changes, corrections, enhancements, modifications, and improvements to ST products and/or to this document at any time without notice. Purchasers should obtain the latest relevant information on ST products before placing orders. ST products are sold pursuant to ST's terms and conditions of sale in place at the time of order acknowledgement.

Purchasers are solely responsible for the choice, selection, and use of ST products and ST assumes no liability for application assistance or the design of Purchasers' products.

No license, express or implied, to any intellectual property right is granted by ST herein.

Resale of ST products with provisions different from the information set forth herein shall void any warranty granted by ST for such product.

ST and the ST logo are trademarks of ST. All other product or service names are the property of their respective owners.

Information in this document supersedes and replaces information previously supplied in any prior versions of this document.

© 2018 STMicroelectronics – All rights reserved