

Noninverting 3-State Buffer

L74VHC1G125

The L74VHC1G125 is an advanced high speed CMOS noninverting 3 state buffer fabricated with silicon gate noninverting 3 state buffer fabricated with silicon gate CMOS technology. It achieves high speed operation similar to equivalent Bipolar Schottky TTL while maintaining CMOS low power dissipation.

The internal circuit is composed of three stages, including a buffered 3-state output which provides high noise immunity and stable output.

The L74VHC1G125 input structure provides protection when voltages up to 7.0V are applied, regardless of the supply voltage. This allows the L74VHC1G125 to be used to interface 5.0V circuits to 3.0V circuits.

Features

- High Speed: $t_{PD} = 3.5 \text{ ns (Typ)}$ at $V_{CC} = 5.0 \text{ V}$
- Low Power Dissipation: $I_{CC} = 1 \mu\text{A (Max)}$ at $T_A = 25^\circ\text{C}$
- Power Down Protection Provided on Inputs
- Balanced Propagation Delays
- Pin and Function Compatible with Other Standard Logic Families
- Chip Complexity: FETs = 58; Equivalent Gates = 15
- Pb-Free Packages are Available

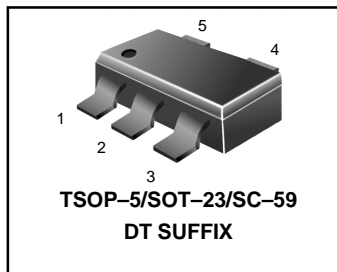
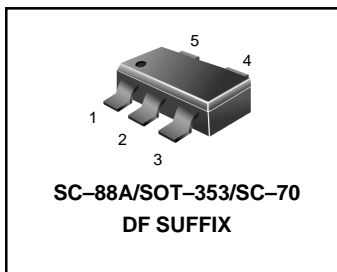

MARKING DIAGRAMS

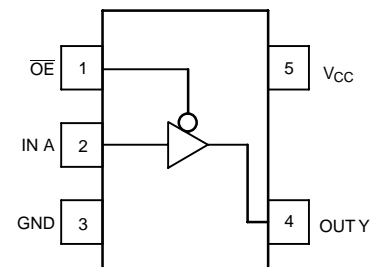
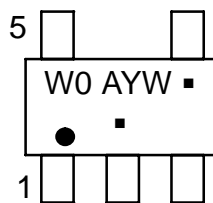
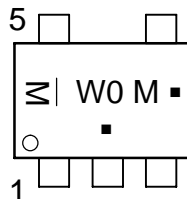

Figure 1. Pinout (Top View)

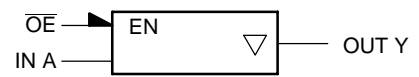

Figure 2. Logic Symbol

PIN ASSIGNMENT	
1	\overline{OE}
2	IN A
3	GND
4	OUT Y
5	V_{CC}

FUNCTION TABLE

A Input	\overline{OE} Input	Y Output
L	L	L
H	L	H
X	H	Z

ORDERING INFORMATION

See detailed ordering and shipping information in the package dimensions section on page 5 of this data sheet.

L74VHC1G125

MAXIMUM RATINGS

Symbol	Characteristics	Value	Unit
V _{CC}	DC Supply Voltage	-0.5 to +7.0	V
V _{IN}	DC Input Voltage	-0.5 to +7.0	V
V _{OUT}	DC Output Voltage	-0.5 to 7.0 -0.5 to V _{CC} + 0.5	V
I _{IK}	Input Diode Current	-20	mA
I _{OK}	Output Diode Current	+20	mA
I _{OUT}	DC Output Current, per Pin	+25	mA
I _{CC}	DC Supply Current, V _{CC} and GND	+50	mA
P _D	Power Dissipation in Still Air	200	mW
θ _{JA}	Thermal Resistance	333	°C/W
T _L	Lead Temperature, 1 mm from Case for 10 s	260	°C
T _J	Junction Temperature Under Bias	+150	°C
T _{stg}	Storage Temperature	-65 to +150	°C
V _{ESD}	ESD Withstand Voltage	> 2000 > 200 N/A	V
I _{Latchup}	Latchup Performance	±500	mA

Maximum ratings are those values beyond which device damage can occur. Maximum ratings applied to the device are individual stress limit values (not normal operating conditions) and are not valid simultaneously. If these limits are exceeded, device functional operation is not implied, damage may occur and reliability may be affected.

1. Tested to EIA/JESD22-A114-A.
2. Tested to EIA/JESD22-A115-A.
3. Tested to JESD22-C101-A.
4. Tested to EIA/JESD78.

RECOMMENDED OPERATING CONDITIONS

Symbol	Characteristics	Min	Max	Unit
V _{CC}	DC Supply Voltage	2.0	5.5	V
V _{IN}	DC Input Voltage	0.0	5.5	V
V _{OUT}	DC Output Voltage	0.0	V _{CC}	V
T _A	Operating Temperature Range	-55	+125	°C
t _r , t _f	Input Rise and Fall Time	0	100	ns/V
	V _{CC} = 3.3 V ± 0.3 V	0	20	
	V _{CC} = 5.0 V ± 0.5 V			

Device Junction Temperature versus Time to 0.1% Bond Failures

Junction Temperature °C	Time, Hours	Time, Years
80	1,032,200	117.8
90	419,300	47.9
100	178,700	20.4
110	79,600	9.4
120	37,000	4.2
130	17,800	2.0
140	8,900	1.0

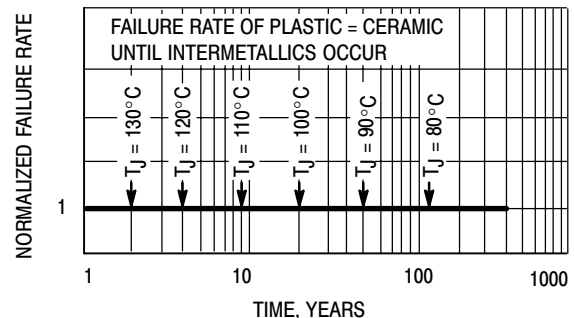

Figure 3. Failure Rate vs. Time Junction Temperature

L74VHC1G125
DC ELECTRICAL CHARACTERISTICS

Symbol	Parameter	Test Conditions	V _{CC} (V)	T _A = 25°C			T _A ≤ 85°C		-55 ≤ T _A ≤ 125°C		Unit
				Min	Typ	Max	Min	Max	Min	Max	
V _{IH}	Minimum High-Level Input Voltage		2.0 3.0 4.5 5.5	1.5 2.1 3.15 3.85			1.5 2.1 3.15 3.85		1.5 2.1 3.15 3.85	V	
V _{IL}	Maximum Low-Level Input Voltage		2.0 3.0 4.5 5.5			0.5 0.9 1.35 1.65		0.5 0.9 1.35 1.65		0.5 0.9 1.35 1.65	V
V _{OH}	Minimum High-Level Output Voltage V _{IN} = V _{IH} or V _{IL}	V _{IN} = V _{IH} or V _{IL} I _{OH} = -50 μA	2.0 3.0 4.5	1.9 2.9 4.4	2.0 3.0 4.5		1.9 2.9 4.4		1.9 2.9 4.4	V	
		V _{IN} = V _{IH} or V _{IL} I _{OH} = -4 mA I _{OH} = -8 mA	3.0 4.5	2.58 3.94			2.48 3.80		2.34 3.66	V	
V _{OL}	Maximum Low-Level Output Voltage V _{IN} = V _{IH} or V _{IL}	V _{IN} = V _{IH} or V _{IL} I _{OL} = 50 μA	2.0 3.0 4.5		0.0 0.0 0.0	0.1 0.1 0.1		0.1 0.1 0.1		0.1 0.1 0.1	V
		V _{IN} = V _{IH} or V _{IL} I _{OL} = 4 mA I _{OL} = 8 mA	3.0 4.5			0.36 0.36	0.44 0.44		0.52 0.52	V	
I _{OZ}	Maximum 3-State Leakage Current	V _{IN} = V _{IH} or V _{IL} V _{OUT} = V _{CC} or GND	5.5			±0.25		±2.5		±2.5	μA
I _{IN}	Maximum Input Leakage Current	V _{IN} = 5.5 V or GND	0 to 5.5			±0.1		±1.0		±1.0	μA
I _{CC}	Maximum Quiescent Supply Current	V _{IN} = V _{CC} or GND	5.5			1.0		20		40	μA

AC ELECTRICAL CHARACTERISTICS C_{load} = 50 pF, Input t_r = t_f = 3.0 ns

Symbol	Parameter	Test Conditions	T _A = 25°C			T _A ≤ 85°C		-55 ≤ T _A ≤ 125°C		Unit
			Min	Typ	Max	Min	Max	Min	Max	
t _{PLH} , t _{PHL}	Maximum Propagation Delay, Input A to Y (Figures 3 and 4)	V _{CC} = 3.3 ± 0.3 V C _L = 15 pF C _L = 50 pF		4.5 6.4	8.0 11.5		9.5 13.0		12.0 16.0	ns
		V _{CC} = 5.0 ± 0.5 V C _L = 15 pF C _L = 50 pF		3.5 4.5	5.5 7.5		6.5 8.5		8.5 10.5	
t _{PZL} , t _{PZH}	Maximum Output Enable Time, Input OE to Y (Figures 4 and 5)	V _{CC} = 3.3 ± 0.3 V C _L = 15 pF R _L = 1000 Ω C _L = 50 pF		4.5 6.4	8.0 11.5		9.5 13.0		11.5 15.0	ns
		V _{CC} = 5.0 ± 0.5 V C _L = 15 pF R _L = 1000 Ω C _L = 50 pF		3.5 4.5	5.1 7.1		6.0 8.0		8.5 10.5	
t _{PLZ} , t _{PHZ}	Maximum Output Disable Time, Input OE to Y (Figures 4 and 5)	V _{CC} = 3.3 ± 0.3 V C _L = 15 pF R _L = 1000 Ω C _L = 50 pF		6.5 8.0	9.7 13.2		11.5 15.0		14.5 18.0	ns
		V _{CC} = 5.0 ± 0.5 V C _L = 15 pF R _L = 1000 Ω C _L = 50 pF		4.8 7.0	6.8 8.8		8.0 10.0		10.0 12.0	
C _{IN}	Maximum Input Capacitance			4.0	10		10		10	pF
C _{OUT}	Maximum 3-State Output Capacitance (Output in High Impedance State)			6.0						pF

C _{PD}	Power Dissipation Capacitance (Note 5)	Typical @ 25°C, V _{CC} = 5.0 V	
		8.0	pF

5. C_{PD} is defined as the value of the internal equivalent capacitance which is calculated from the operating current consumption without load. Average operating current can be obtained by the equation: I_{CC(OPR)} = C_{PD} • V_{CC} • f_{in} + I_{CC}. C_{PD} is used to determine the no-load dynamic power consumption; P_D = C_{PD} • V_{CC}² • f_{in} + I_{CC} • V_{CC}.

L74VHC1G125

SWITCHING WAVEFORMS

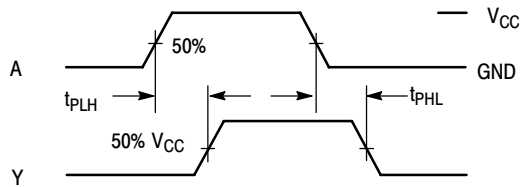

Figure 4. Switching Wave Forms

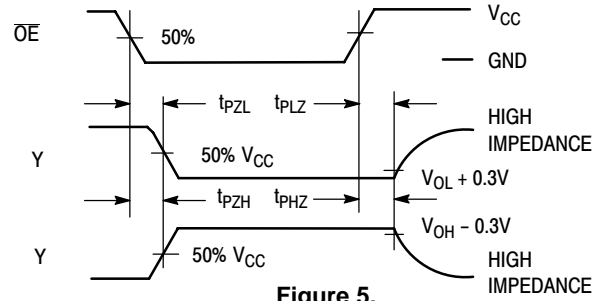
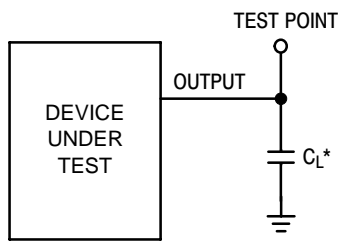
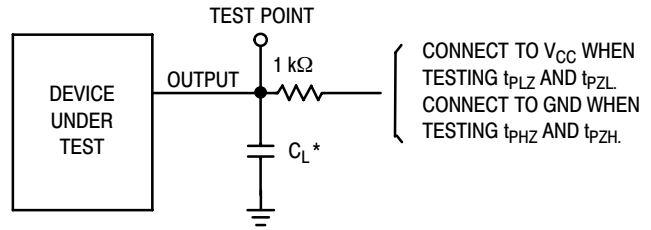

Figure 5.



*Includes all probe and jig capacitance

Figure 6. Test Circuit



*Includes all probe and jig capacitance

Figure 7. Test Circuit

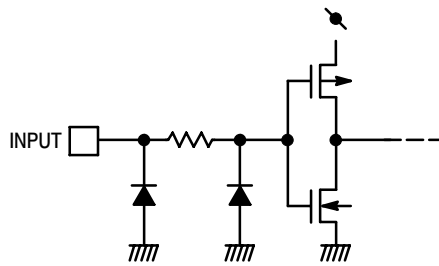

Figure 8. Input Equivalent Circuit

DEVICE ORDERING INFORMATION

Device Order Number	Device Nomenclature						Package Type (Name/SOT#/Common Name)	Tape and Reel Size
	Circuit Indicator	Temp Range Identifier	Technology	Device Function	Package Suffix	Tape & Reel Suffix		
L74VHC1G125DFT1	L	74	VHC1G	125	DF	T1	SC-70/SC-88A/ SOT-353	178 mm (7 in) 3000 Unit
L74VHC1G125DFT2	L	74	VHC1G	125	DF	T2	SC-70/SC-88A/ SOT-353	178 mm (7 in) 3000 Unit
L74VHC1G125DFT4	L	74	VHC1G	125	DF	T4	SC-70/SC-88A/ SOT-353	330 mm (13 in) 10,000 Unit
L74VHC1G125DTT1	L	74	VHC1G	125	DT	T1	SOT-23/TSOPS/ SC-59	178 mm (7 in) 3000 Unit
L74VHC1G125DTT3	L	74	VHC1G	125	DT	T3	SOT-23/TSOPS/ SC-59	330 mm (13 in) 10,000 Unit

L74VHC1G125

PACKAGE DIMENSIONS

SC-88A / SOT-353 / SC70

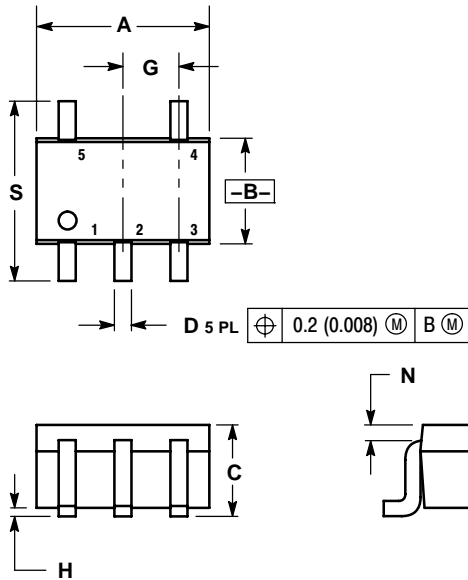

NOTES:

1. DIMENSIONING AND TOLERANCING PER ANSI Y14.5M, 1982.
2. CONTROLLING DIMENSION: INCH.
3. 419A-01 OBSOLETE. NEW STANDARD 419A-02.
4. DIMENSIONS A AND B DO NOT INCLUDE MOLD FLASH, PROTRUSIONS, OR GATE BURRS.

DIM	INCHES		MILLIMETERS	
	MIN	MAX	MIN	MAX
A	0.071	0.087	1.80	2.20
B	0.045	0.053	1.15	1.35
C	0.031	0.043	0.80	1.10
D	0.004	0.012	0.10	0.30
G	0.026 BSC		0.65 BSC	
H	---	0.004	---	0.10
J	0.004	0.010	0.10	0.25
K	0.004	0.012	0.10	0.30
N	0.008 REF		0.20 REF	
S	0.079	0.087	2.00	2.20

SOLDERING FOOTPRINT*

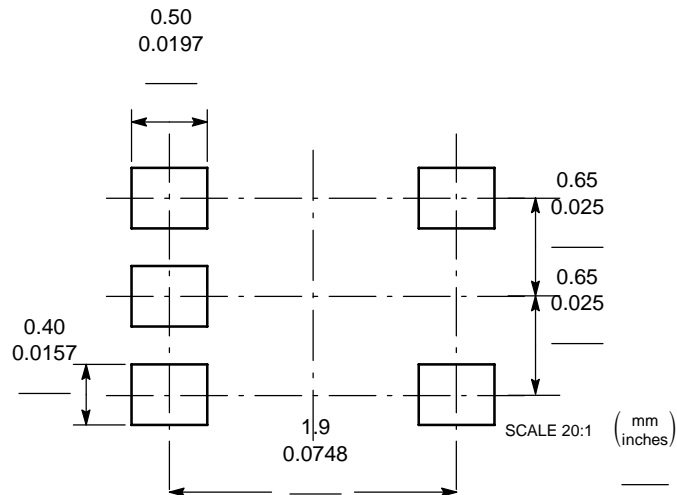

L74VHC1G125

PACKAGE DIMENSIONS

TSOP-5 / SOT23-5 / SC59-5
DT SUFFIX

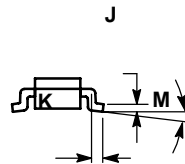
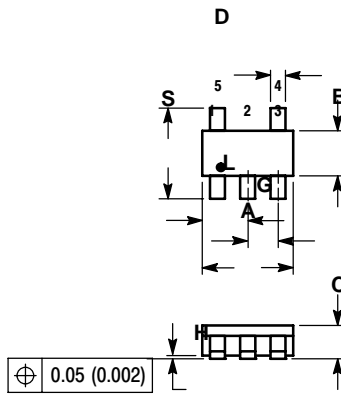

NOTES:

1. DIMENSIONING AND TOLERANCING PER ANSI Y14.5M, 1982.
2. CONTROLLING DIMENSION: MILLIMETER.
3. MAXIMUM LEAD THICKNESS INCLUDES LEAD FINISH THICKNESS. MINIMUM LEAD THICKNESS IS THE MINIMUM THICKNESS OF BASE MATERIAL.
4. A AND B DIMENSIONS DO NOT INCLUDE MOLD FLASH, PROTRUSIONS, OR GATE BURRS.

DIM	MILLIMETERS		INCHES	
	MIN	MAX	MIN	MAX
A	2.90	3.10	0.1142	0.1220
B	1.30	1.70	0.0512	0.0669
C	0.90	1.10	0.0354	0.0433
D	0.25	0.50	0.0098	0.0197
G	0.85	1.05	0.0335	0.0413
H	0.013	0.100	0.0005	0.0040
J	0.10	0.26	0.0040	0.0102
K	0.20	0.60	0.0079	0.0236
L	1.25	1.55	0.0493	0.0610
M	0°	10°	0°	10°
S	2.50	3.00	0.0985	0.1181

SOLDERING FOOTPRINT*

