

2-Input AND Gate with Open Drain Output with LSTTL-Compatible Inputs

L74VHC1GT09

The L74VHC1GT09 is an advanced high speed CMOS 2-input AND gate with open drain output fabricated with silicon gate CMOS technology. It achieves high speed operation similar to equivalent Bipolar Schottky TTL while maintaining CMOS low power dissipation.

The internal circuit is composed of three stages, including an open drain output which provides the ability to set output switching level. This allows the L74VHC1GT09 to be used to interface 5 V circuits to circuits of any voltage between V_{CC} and 7 V using an external resistor and power supply.

The device input is compatible with TTL-type input thresholds and the output has a full 5.0 V CMOS level output swing. The input protection circuitry on this device allows overvoltage tolerance on the input, allowing the device to be used as a logic-level translator from 3.0 V CMOS logic to 5.0 V CMOS Logic or from 1.8 V CMOS logic to 3.0 V CMOS Logic while operating at the high-voltage power supply.

The L74VHC1GT09 input structure provides protection when voltages up to 7 V are applied, regardless of the supply voltage. This allows the L74VHC1GT09 to be used to interface 5 V circuits to 3 V circuits. The output structures also provide protection when $V_{CC} = 0$ V. These input and output structures help prevent device destruction caused by supply voltage – input/output voltage mismatch, battery backup, hot insertion, etc.

- High Speed: $t_{PD} = 4.3$ ns (Typ) at $V_{CC} = 5$ V
- Low Internal Power Dissipation: $I_{CC} = 2$ mA (Max) at $T_A = 25^\circ\text{C}$
- Power Down Protection Provided on Inputs
- Pin and Function Compatible with Other Standard Logic Families
- Chip Complexity: FETs = 62; Equivalent Gates = 16

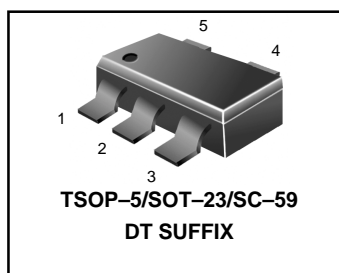
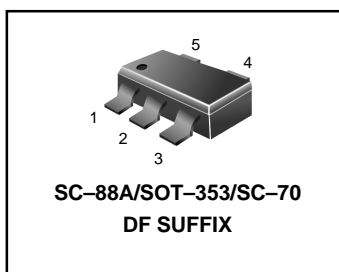

PIN ASSIGNMENT	
1	IN B
2	IN A
3	GND
4	OUT Y
5	V_{CC}

MARKING DIAGRAMS

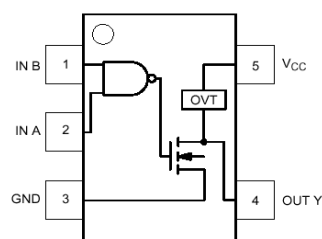
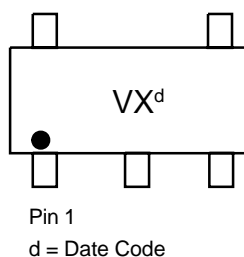
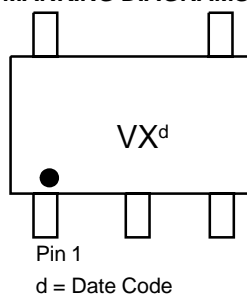

Figure 1. Pinout (Top View)

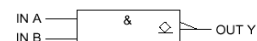

Figure 2. Logic Symbol

FUNCTION TABLE

Inputs		Output
A	B	Y
L	L	L
L	H	L
H	L	L
H	H	Z

ORDERING INFORMATION

See detailed ordering and shipping information in the package dimensions section on page 5 of this data sheet.

L74VHC1GT09

MAXIMUM RATINGS

Symbol	Parameter	Value	Unit
V _{CC}	DC Supply Voltage	- 0.5 to + 7.0	V
V _{IN}	DC Input Voltage	- 0.5 to +7.0	V
V _{OUT}	DC Output Voltage	- 0.5 to +7.0	V
I _{IK}	Input Diode Current	-20	mA
I _{OK}	Output Diode Current	V _{OUT} < GND; V _{OUT} > V _{CC}	+20 mA
I _{OUT}	DC Output Current, per Pin	+ 25	mA
I _{CC}	DC Supply Current, V _{CC} and GND	+50	mA
P _D	Power dissipation in still air	SC-88A, TSOP-5	200 mW
θ _{JA}	Thermal resistance	SC-88A, TSOP-5	333 °C/W
T _L	Lead Temperature, 1 mm from Case for 10 s	260	°C
T _J	Junction Temperature Under Bias	+ 150	°C
T _{stg}	Storage temperature	-65 to +150	°C
V _{ESD}	ESD Withstand Voltage	Human Body Model (Note 2) Machine Model (Note 3) Charged Device Model (Note 4)	>2000 > 200 N/A
I _{LATCH-UP}	Latch-Up Performance	Above V _{CC} and Below GND at 125°C (Note 5)	± 500 mA

1. Maximum Ratings are those values beyond which damage to the device may occur. Exposure to these conditions or conditions beyond those indicated may adversely affect device reliability. Functional operation under absolute-maximum-rated conditions is not implied. Functional operation should be restricted to the Recommended Operating Conditions.
2. Tested to EIA/JESD22-A114-A
3. Tested to EIA/JESD22-A115-A
4. Tested to JESD22-C101-A
5. Tested to EIA/JESD78

RECOMMENDED OPERATING CONDITIONS

Symbol	Parameter	Min	Max	Unit
V _{CC}	DC Supply Voltage	2.0	5.5	V
V _{IN}	DC Input Voltage	0.0	5.5	V
V _{OUT}	DC Output Voltage	0.0	7.0	V
T _A	Operating Temperature Range	- 55	+ 125	°C
t _r , t _f	Input Rise and Fall Time	V _{CC} = 3.3 ± 0.3 V V _{CC} = 5.0 ± 0.5 V	0 100 20	ns/V

DEVICE JUNCTION TEMPERATURE VERSUS TIME TO 0.1% BOND FAILURES

Junction Temperature °C	Time, Hours	Time, Years
80	1,032,200	117.8
90	419,300	47.9
100	178,700	20.4
110	79,600	9.4
120	37,000	4.2
130	17,800	2.0
140	8,900	1.0

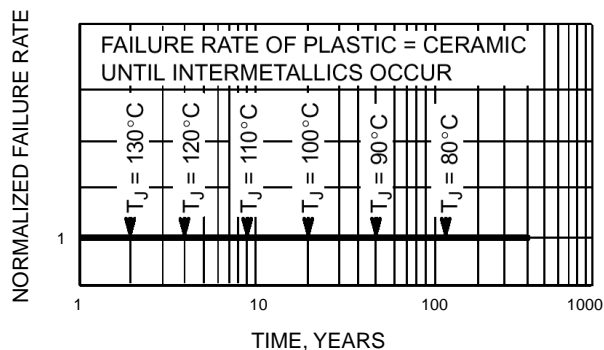

Figure 3. Failure Rate vs. Time Junction Temperature

L74VHC1GT09

DC ELECTRICAL CHARACTERISTICS

Symbol	Parameter	Test Conditions	V _{CC} (V)	T _A = 25°C			T _A ≤ 85°C		-55°C ≤ T _A ≤ 125°C		Unit
				Min	Typ	Max	Min	Max	Min	Max	
V _{IH}	Minimum High-Level Input Voltage		3.0	1.4			1.4		1.4		V
			4.5	2.0			2.0		2.0		
			5.5	2.0			2.0		2.0		
V _{IL}	Maximum Low-Level Input Voltage		3.0								V
			4.5			0.53		0.53		0.53	
			5.5			0.8		0.8		0.8	
V _{OH}	Minimum High-Level Output Voltage V _{IN} = V _{IH} or V _{IL}	V _{IN} = V _{IH} or V _{IL} I _{OH} = -50 μA	2.0	1.9	2.0			1.9			V
			3.0	2.9	3.0			2.9		2.9	
			4.5	4.4	4.0			4.4		4.4	
		V _{IN} = V _{IH} or V _{IL} I _{OH} = -4 mA I _{OH} = -8 mA	3.0	2.58				2.48		2.34	
			4.5	3.94				3.80		3.66	
V _{OL}	Maximum Low-Level Output Voltage V _{IN} = V _{IH} or V _{IL}	V _{IN} = V _{IH} or V _{IL} I _{OL} = 50 μA	2.0		0.0	0.1		0.1		0.1	V
			3.0		0.0	0.1		0.1		0.1	
			4.5		0.0	0.1		0.1		0.1	
		V _{IN} = V _{IH} or V _{IL} I _{OL} = 4 mA I _{OL} = 8 mA	3.0			0.36		0.44		0.52	
			4.5			0.36		0.44		0.52	
I _{IN}	Maximum Input Leakage Current	V _{IN} = 5.5 V or GND	0 to 5.5			±0.1		±1.0		μA	
I _{CC}	Maximum Quiescent Supply Current	V _{IN} = V _{CC} or GND	5.5			2.0		20		40	μA
I _{OPD}	Maximum Off-state Leakage Current	V _{OUT} = 5.5 V	0			0.25		2.5		5.0	μA

AC ELECTRICAL CHARACTERISTICS C_{load} = 50 pF, Input t_r = t_f = 3.0 ns

Symbol	Parameter	Test Conditions	T _A = 25°C			T _A ≤ 85°C		-55°C to 125°C		Unit
			Min	Typ	Max	Min	Max	Min	Max	
t _{PZL}	Maximum Output Enable Time, Input A or B to Y	V _{CC} = 3.3 ± 0.3 V C _L = 15 pF R _L = R _I = 500 Ω C _L = 50 pF		6.2	8.8		10.5		12.5	ns
				8.7	12.3		14.0		16.5	
t _{PLZ}	Maximum Output Disable Time	V _{CC} = 5.0 ± 0.5 V C _L = 15 pF R _L = R _I = 500 Ω C _L = 50 pF		4.3	5.9		7.0		9.0	ns
				5.8	7.9		9.0		11.0	
t _{PLZ}	Maximum Output Disable Time	V _{CC} = 3.3 ± 0.3 V C _L = 50 pF R _L = R _I = 500 Ω		8.7	12.3		14.0		16.5	ns
				5.8	7.9		9.0		11.0	
C _{IN}	Maximum Input Capacitance			6.0	10		10		10	pF

			Typical @ 25°C, V _{CC} = 5.0 V				
C _{PD}	Power Dissipation Capacitance (Note 6)		18				pF

6. C_{PD} is defined as the value of the internal equivalent capacitance which is calculated from the operating current consumption without load. Average operating current can be obtained by the equation: I_{CC(OPR)} = C_{PD} X V_{CC} X f_{in} + I_{CC}. C_{PD} is used to determine the no-load dynamic power consumption; P_D = C_{PD} X V_{CC}² X f_{in} + I_{CC} X V_{CC}.

L74VHC1GT09

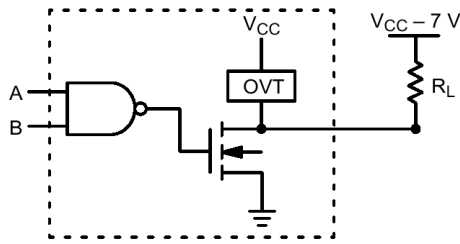

Figure 4. Output Voltage Mismatch Application

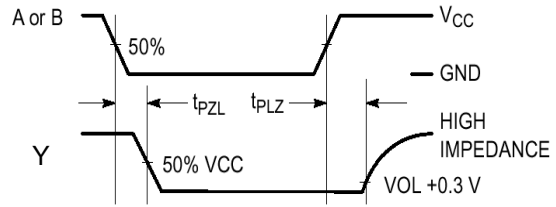
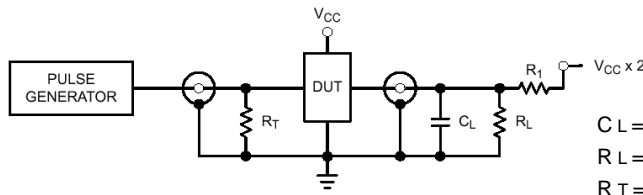

Figure 5. Switching Waveforms



C L = 50 pF equivalent (Includes jig and probe capacitance)
 R L = R 1 = 500 Ω or equivalent
 R T = Z OUT of pulse generator (typically 50 Ω)

Figure 6. Test Circuit

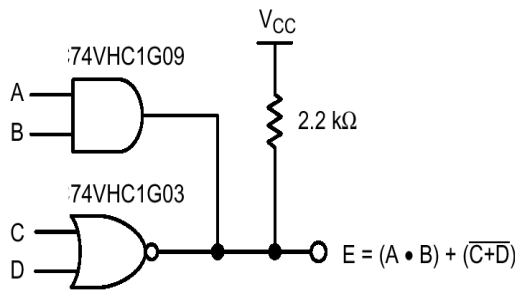

Figure 7. Complex Boolean Functions

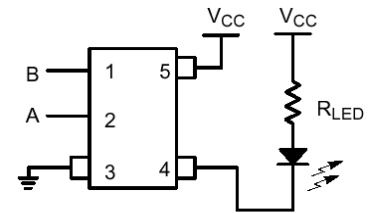

Figure 8. LED Driver

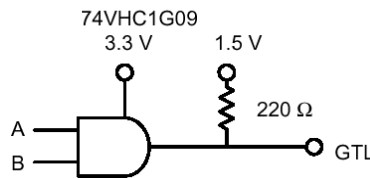

Figure 9. GTL Driver

DEVICE ORDERING INFORMATION

Device Nomenclature								
Device Order Number	Logic Circuit Indicator	Temp Range Identifier	Technology	Device Function	Package Suffix	Tape and Reel Suffix	Package Type (Name/SOT#/Common Name)	Tape and Reel Size
L74VHC1GT09DFT1	L	74	VHC1G	T09	DF	T1	SC-70/SC-88A/ SOT-353	178 mm (7 in) 3000 Unit
L74VHC1GT09DFT2	L	74	VHC1G	T09	DF	T2	SC-70/SC-88A/ SOT-353	178 mm (7 in) 3000 Unit
L74VHC1GT09DFT4	L	74	VHC1G	T09	DF	T4	SC-70/SC-88A/ SOT-353	330 mm (13 in) 10,000 Unit
L74VHC1GT09DTT1	L	74	VHC1G	T09	DT	T1	SOT-23/TSOPS/ SC-59	178 mm (7 in) 3000 Unit
L74VHC1GT09DTT3	L	74	VHC1G	T09	DT	T3	SOT-23/TSOPS/ SC-59	330 mm (13 in) 10,000 Unit

L74VHC1GT09

PACKAGE DIMENSIONS SC70-5/SC-88A/SOT-353 DF SUFFIX

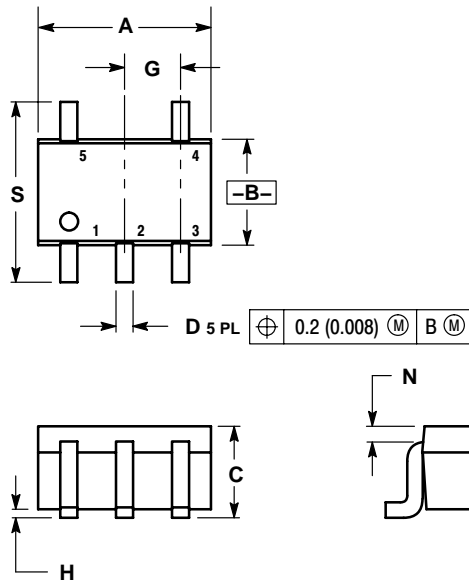

- NOTES:
1. DIMENSIONING AND TOLERANCING PER ANSI Y14.5M, 1982.
 2. CONTROLLING DIMENSION: INCH.
 3. 419A-01 OBSOLETE. NEW STANDARD 419A-02.
 4. DIMENSIONS A AND B DO NOT INCLUDE MOLD FLASH, PROTRUSIONS, OR GATE BURRS.

DIM	INCHES		MILLIMETERS	
	MIN	MAX	MIN	MAX
A	0.071	0.087	1.80	2.20
B	0.045	0.053	1.15	1.35
C	0.031	0.043	0.80	1.10
D	0.004	0.012	0.10	0.30
G	0.026 BSC		0.65 BSC	
H	---	0.004	---	0.10
J	0.004	0.010	0.10	0.25
K	0.004	0.012	0.10	0.30
N	0.008 REF		0.20 REF	
S	0.079	0.087	2.00	2.20

SOLDERING FOOTPRINT*

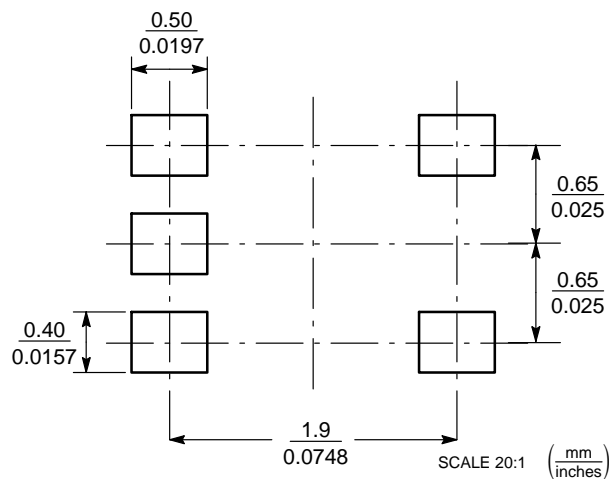

L74VHC1GT09

PACKAGE DIMENSIONS

SOT23-5/TSOP-5/SC59-5
DT SUFFIX

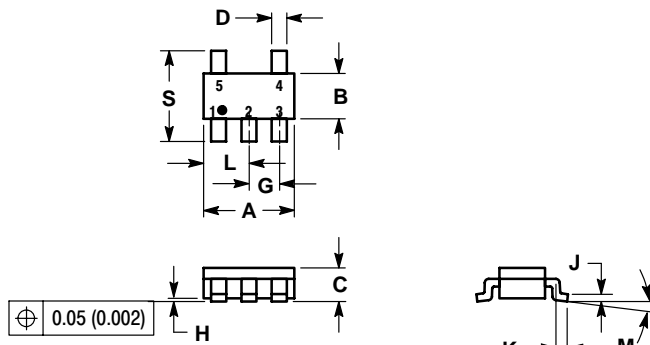

NOTES:

1. DIMENSIONING AND TOLERANCING PER ANSI Y14.5M, 1982.
2. CONTROLLING DIMENSION: MILLIMETER.
3. MAXIMUM LEAD THICKNESS INCLUDES LEAD FINISH THICKNESS. MINIMUM LEAD THICKNESS IS THE MINIMUM THICKNESS OF BASE MATERIAL.
4. A AND B DIMENSIONS DO NOT INCLUDE MOLD FLASH, PROTRUSIONS, OR GATE BURRS.

DIM	MILLIMETERS		INCHES	
	MIN	MAX	MIN	MAX
A	2.90	3.10	0.1142	0.1220
B	1.30	1.70	0.0512	0.0669
C	0.90	1.10	0.0354	0.0433
D	0.25	0.50	0.0098	0.0197
G	0.85	1.05	0.0335	0.0413
H	0.013	0.100	0.0005	0.0040
J	0.10	0.26	0.0040	0.0102
K	0.20	0.60	0.0079	0.0236
L	1.25	1.55	0.0493	0.0610
M	0	10	0	10
S	2.50	3.00	0.0985	0.1181

SOLDERING FOOTPRINT*

