

Infrared LED

L9437

LED emitting collimated light for optical encoder

L9437 is an infrared LED developed for optical encoders. By improving the aspherical lens used with the previous type L8506, we have achieved an even more highly collimated beam of near infrared light. The lead pin of L9437 has no step piece that is usually formed at the lead base brazed to the package, thus eliminating the restriction in printed circuit board design.

Features

- Collimated light beam
- Uniform light spot
- Narrow directivity: $\pm 5^\circ$
- High-speed response: 40 MHz Typ.
- High reliability

Applications

- Optical encoder

■ Absolute maximum ratings (Ta=25 °C, unless otherwise noted)

Parameter	Symbol	Condition	Value	Unit
Reverse voltage	VR		5	V
Forward current	IF		80	mA
Forward current reduction rate	-		0.67	mA/°C
Pulse forward current	IFP	Pulse width=10 μ s Duty ratio=1 %	0.5	A
Pulse forward current reduction rate	-		4.2	mA/°C
Power dissipation	P		150	mW
Operating temperature	Topr		-30 to +85	°C
Storage temperature	Tstg		-40 to +100	°C

■ Electrical and optical characteristics (Ta=25 °C)

Parameter	Symbol	Condition	Min.	Typ.	Max.	Unit
Peak emission wavelength	λ_p	IF=30 mA	840	870	900	nm
Spectral half width	$\Delta\lambda$	IF=30 mA	-	45	-	nm
Optical output *1	Pe	IF=30 mA	1.25	1.6	-	mW
Forward voltage	VF	IF=30 mA	-	1.5	1.65	V
Reverse current	IR	VR=5 V	-	-	5	μ A
Light spot size *2	Bw	IF=30 mA	4.0 *3	4.3	-	mm
Cut-off frequency *4	fc	IF=30 mA \pm 4 mAp-p	25	40	-	MHz

*1: Measured with a photodiode (active area: $\phi 8$ mm) installed 25 mm away from LED stem undersurface.

*2: Full width at half maximum of beam spot measured with an image sensor installed 13 mm away from LED stem undersurface.

*3: Reference value

*4: Frequency at which the optical output drops by -3 dB from that at 100 kHz.

Emission spectrum

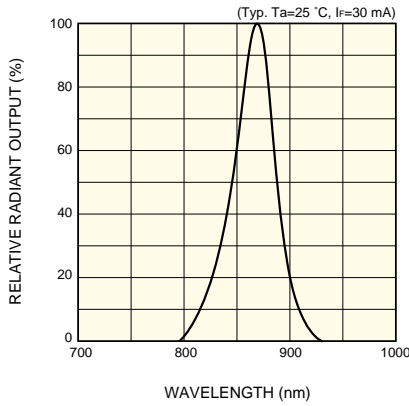

KLEDB0218EA

Optical output vs. forward current

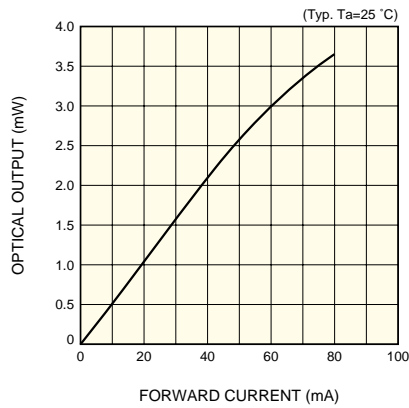

KLEDB0303EA

Forward current vs. forward voltage

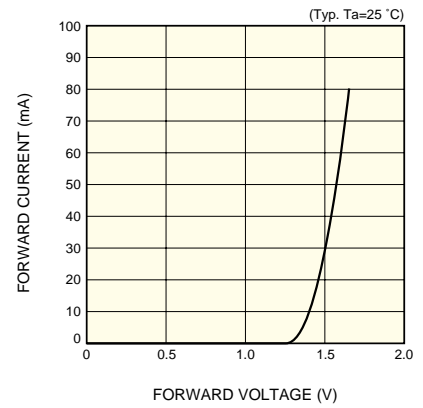

KLEDB0227EB

Directivity

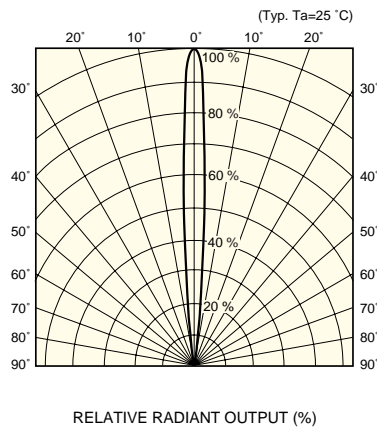

KLEDB0226EA

Radiant output vs. ambient temperature

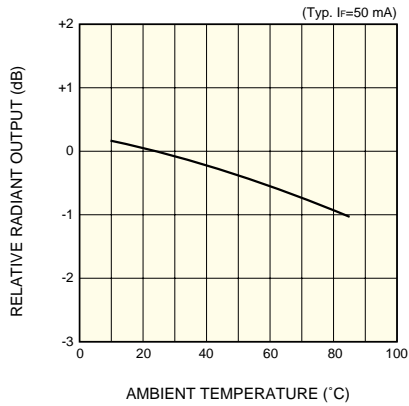

KLEDB0228EA

Allowable forward current vs. ambient temperature

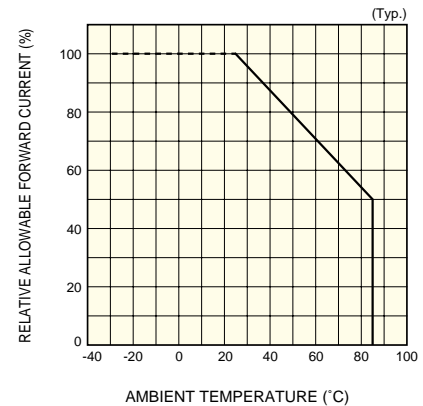

KLEDB0229EB

Allowable forward current vs. duty ratio

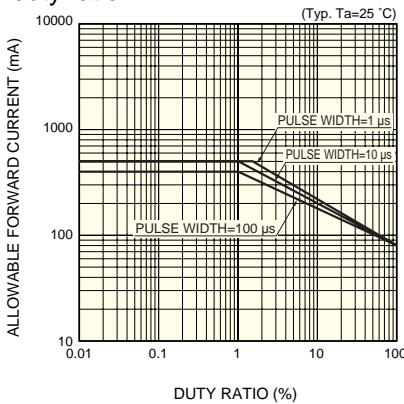

KLEDB0228EA

Light intensity distribution

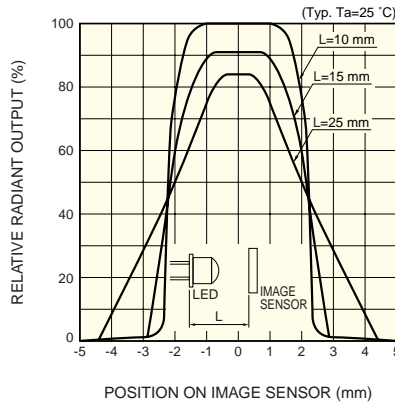

KLEDB0263EB

Dimensional outline (unit: mm)

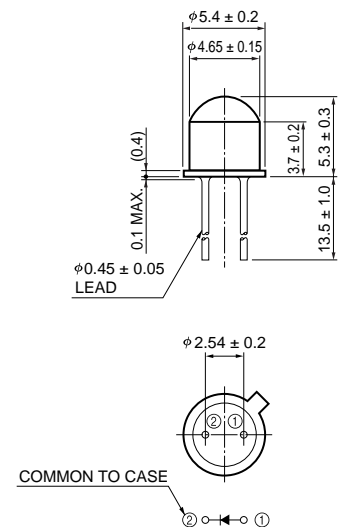

KLEDA0082EA

HAMAMATSU

HAMAMATSU PHOTONICS K.K., Solid State Division

1126-1 Ichino-cho, Higashi-ku, Hamamatsu City, 435-8558 Japan, Telephone: (81) 53-434-3311, Fax: (81) 53-434-5184, www.hamamatsu.com

U.S.A.: Hamamatsu Corporation, 360 Foothill Road, P.O.Box 6910, Bridgewater, N.J. 08807-0910, U.S.A., Telephone: (1) 908-231-0960, Fax: (1) 908-231-1218

Germany: Hamamatsu Photonics Deutschland GmbH, Arzbergerstr. 10, D-82211 Herrsching am Ammersee, Germany, Telephone: (49) 08152-3750, Fax: (49) 08152-2658

France: Hamamatsu Photonics France S.A.R.L.: 19, Rue du Saule Trépu, Parc du Moulin de Massy, 91882 Massy Cedex, France, Telephone: 33-(1) 69 53 71 00, Fax: 33-(1) 69 53 71 10

United Kingdom: Hamamatsu Photonics UK Limited, 2 Howard Court, 10 Tewin Road, Welwyn Garden City, Hertfordshire AL7 1BW, United Kingdom, Telephone: (44) 1707-294888, Fax: (44) 1707-325777

North Europe: Hamamatsu Photonics Norden AB, Smidesvägen 12, SE-171 41 Solna, Sweden, Telephone: (46) 8-509-031-00, Fax: (46) 8-509-031-01

Italy: Hamamatsu Photonics Italia S.p.A., Strada della Moia, 1/E, 20020 Arese, (Milano), Italy, Telephone: (39) 02-935-81-733, Fax: (39) 02-935-81-741

Information furnished by HAMAMATSU is believed to be reliable. However, no responsibility is assumed for possible inaccuracies or omissions. Specifications are subject to change without notice. No patent rights are granted to any of the circuits described herein. ©2007 Hamamatsu Photonics K.K.

Cat. No. KLED1045E03
Aug. 2007 DN