

LA1247 — AM Electronic Tuner

Monolithic Linear IC

The LA1247 is a high-performance IC developed for AM electronic tuning systems. It performs all the functions needed for AM tuner systems and also provides auto search stop signal, local oscillation buffer output, low-level local oscillation. Moreover, the local oscillation is stable from LW to SW, facilitating multiband applications.

Functions

- RF amplification
- OSC (with ALC)
- Detection
- Signal meter drive output (also used as auto search stop signal)
- Others
- MIX
- IF amplification
- AGC
- Local oscillation buffer output

Features

1. Narrow-band signal meter: Usable as auto search stop signal (possible to make wide-band) Signal meter output 1/2 frequency ± 1.5 kHz typ.
2. Local oscillation buffer output: Easy to design electronic tuning frequency display
3. LSC (with ALC): Stabilized oscillation output for varactor diode and improved tracking error
4. RF amplification: Excellent usable sensitivity (45 dB/m typ.) due to low noise transistor cascode connection.
5. MIX: Highly resistant to spurious interference, IF interference due to double balanced type differential MIX (IF interference = 85 dB typ.)
6. Low noise: Good S/N (57 dB typ.) for medium input
7. VCC variation compensation: Little variation in gain, distortion, etc. (8 to 16 V)
8. Pop noise reduction: Possible to reduce pop noise at the time of VCC-on, mode-on by selecting AGC time constant
9. Meeting AM stereo requirements: Subchannel S/N is more improved as compared with the LA1245.

Information furnished by SANYO is believed to be accurate and reliable. However, no responsibility is assumed by SANYO for its use, nor for any infringements of patents or other rights of third parties which may result from its use, and no license is granted by implication or otherwise, under any patent or patent rights of SANYO.

Case Outline 3021B-D20SIC
(unit:mm)

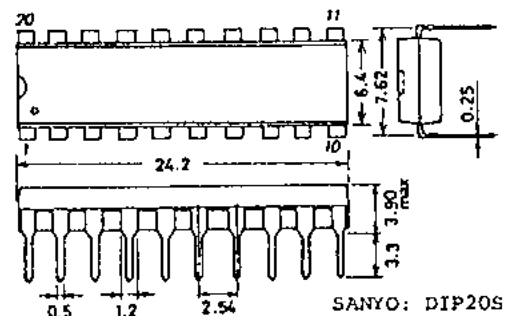

Specifications and information herein are subject to change without notice.

SANYO Electric Co., Ltd. Semiconductor Company

TOKYO OFFICE Tokyo Bldg., 1-10, 1 Chome, Ueno, Taito-ku, TOKYO, 110-8534 JAPAN

Maximum Ratings at $T_a = 25^\circ\text{C}$

				unit
Supply voltage	V_{CC} max	Pin 8, 14	16	V
Output voltage	V_O	Pin 5, 7	24	V
Input voltage	V_I	Pin 3	5.6	V
Supply current	I_{CC} max	Pin 5 + 7 + 8 + 14	32	mA
Output high drive current	I_{18}	Pin 18	5	mA
	I_{20}	Pin 20	2	mA
Allowable power dissipation	P_D max	See Fig. 2	700	mW
Operating temperature	T_{opg}		$-20 \sim +70$	$^\circ\text{C}$
Storage temperature	T_{stg}		$-40 \sim +125$	$^\circ\text{C}$

Recommended Operating Condition at $T_a = 25^\circ\text{C}$

				unit
Recommended supply voltage	V_{CC}		12	V
Operating voltage range	V_{CC}		8 ~ 16	V

Operating Characteristics at $T_a = 25^\circ\text{C}$, $V_{CC} = 12\text{ V}$, $f_r = 1\text{ MHz}$, $f_m = 400\text{ Hz}$, at specified test circuit (based on application circuit).

			min	typ	max	unit
Current dissipation	I_{CC} (1)	quiescent	16.0	25.0	35.0	mA
	I_{CC} (2)	with 107 dB μ input	19.0	29.0	40.0	mA
Detection output	V_O (1)	with 23 dB μ input, mod. 30 %	-27.5	-23.0	-18.5	dBm
	V_O (2)	with 80 dB μ input, mod. 30 %	-15.5	-12.5	-9.5	dBm
Signal to noise ratio	S/N (1)	with 23 dB μ input, mod. 30 %	16	20		dB
	S/N (2)	with 80 dB μ input, mod. 30 %	52	57		dB
Total harmonic distortion	THD (1)	with 80 dB μ input, mod. 30 %		0.4	1.0	%
	THD (2)	with 107 dB μ input, mod. 30 %		0.3	1.0	%
Signal meter output	VSM (1)	quiescent		0	0.5	V
	VSM (3)	with 107 dB μ input	3.5	5.0	7.0	V
Input at signal meter output = 1 V	V_{IN} (1)	VSM output 1V	20.0	26.0	32.0	dB μ
Local oscillation-buffer output	V_{osc}		380	530		mVrms

Reference Characteristics

			typ	unit
Signal meter output	VSM (2)	with 40 dB μ input	2.5	V
Total harmonic distortion	THD (3)	with 112 dB μ input, mod. 30 %	2	%
Local oscillation fluctuation within a band	ΔV_{osc}	from V_{oscL} (522 kHz) to V_{oscH} (1647 kHz)	10	mVrms
Signal meter band width*	VSM-BW1	with 80 dB μ input, 1/2 output frequency	± 1.5	kHz
	VSM-BW2	with 80 dB μ input, 1/10 output frequency	-4.5/+7	kHz
Selectivity		$\pm 10\text{ kHz}$ at 30 % mod.	45	dB
IF Interference		$f_r = 600\text{ kHz}$	85	dB
Image frequency interference ratio		$f_r = 1400\text{ kHz}$	40	dB
AM stereo subchannel	S/N	Subchannel S	50	dB

* BFB450C4 N (MURATA, JAPAN) was used as a narrow band filter.

(note) 0 dBm = 775 mV, 0 dB μ = 1 μ V.

Using the automatic search-stop signal

Signal Meter-driving output is equivalent to Fig.1, signal meter driving output (abbreviated as V_{SM}) is narrowed in band width and can be used as an automatic search-stop signal when a narrow band series resonator is connected to pin 15. V_{SM} can be adjusted with R_{208} and R_{211} both in wide band and narrow band since R_{208} is inversely proportional to V_{SM} , while R_{211} is proportional to V_{SM} . R_{208} is related to the Q of narrow band signal meter. When the resistance of R_{208} is increased, the Q will be damped and the band width increased. On the other hand, R_{211} used as the output impedance of V_{SM} and affects the cut-off frequency and time constant of low pass filter for V_{SM} and the meter drive impedance. The time constant and the cut-off frequency f_c can be expressed as follows:

$$\tau = (C_{114} + C_{115} + C_s) \times (R_{211} / R_{in})$$

$$f_c = \frac{1}{2\pi\tau}$$

A semi-fixed resistor is recommended to be used as R_{211} to allow the fluctuation of V_{SM} . Refer to Fig. 3 for the value of the semi-fixed resistor since this depends upon V_{SM} and R_{208} . Fig. 3 shows the lowest limit of the semi-fixed resistor in relation to R_{208} with the parameter of V_{SM} set point the value of the semi-fixed resistor will be equal to or greater than that shown in Fig. 3. For example, when $V_{SM} = 5$ V and $R_{208} = 240$ ohm, R_{211} becomes 28 kohm. Thus, the value of the semi-fixed resistor is determined to be about 30 kohm. When the value of V_{SM} is too large, it is limited and saturated to the source voltage so it is recommended to follow the condition of $V_{SM} \leq V_{CC} - 2$ (V). When a narrow band serial resonator is used, include the resonant impedance to determine the value of R_{208} .

Fig. 1 Signal Meter Detector Circuit

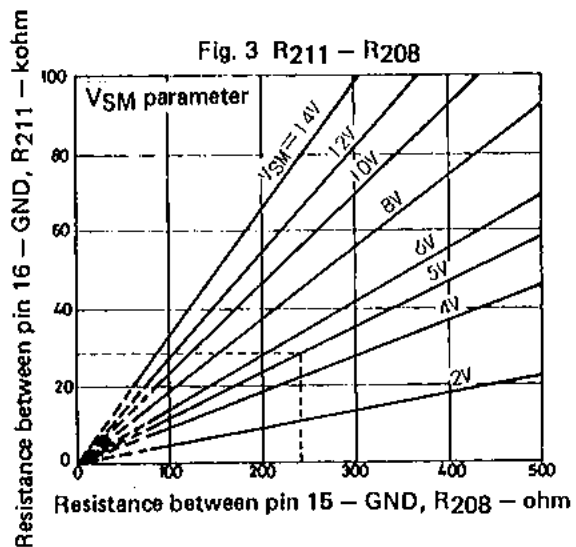
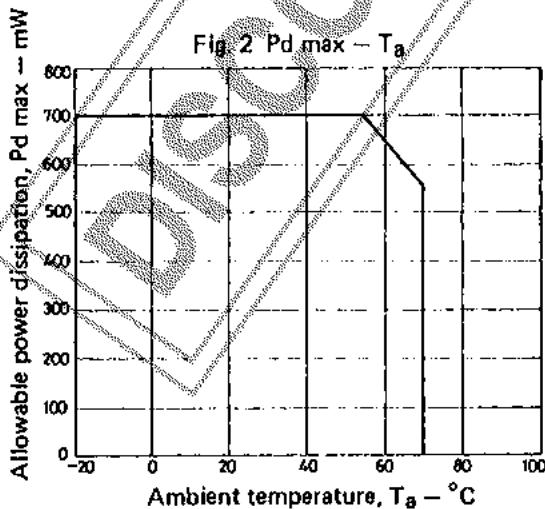
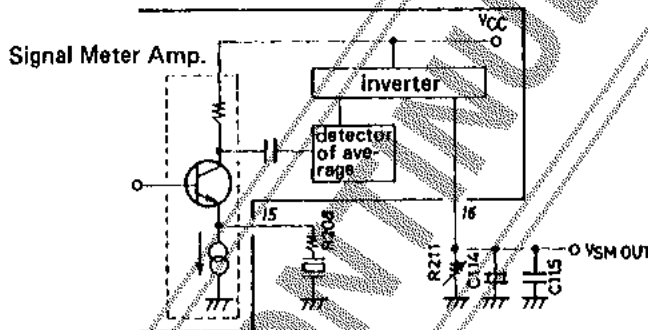

Input/Output Admittance

—	parameter	frequency	—	AGC-off	AGC-on
RF	y_{i3}	1 MHz	r_i c_j	8 k Ω 30 pF	40 k Ω 13 pF
	y_{o5}	1 MHz	r_o c_o	— 4 pF	— —
MIX	y_{i6}	1 MHz	r_i c_j	10 k Ω 2.6 pF	— —
	y_{o7}	500 kHz	r_o c_o	— 2 pF	— —
1st IF	y_{i9}	500 kHz	r_i c_j	3 k Ω 7 pF	3.2 k Ω 3 pF
	y_{o10}	500 kHz	r_o c_o	45 Ω 20 pF	42 Ω 20 pF
2nd IF	y_{i11}	500 kHz	r_i c_j	80 Ω —150 pF	— —

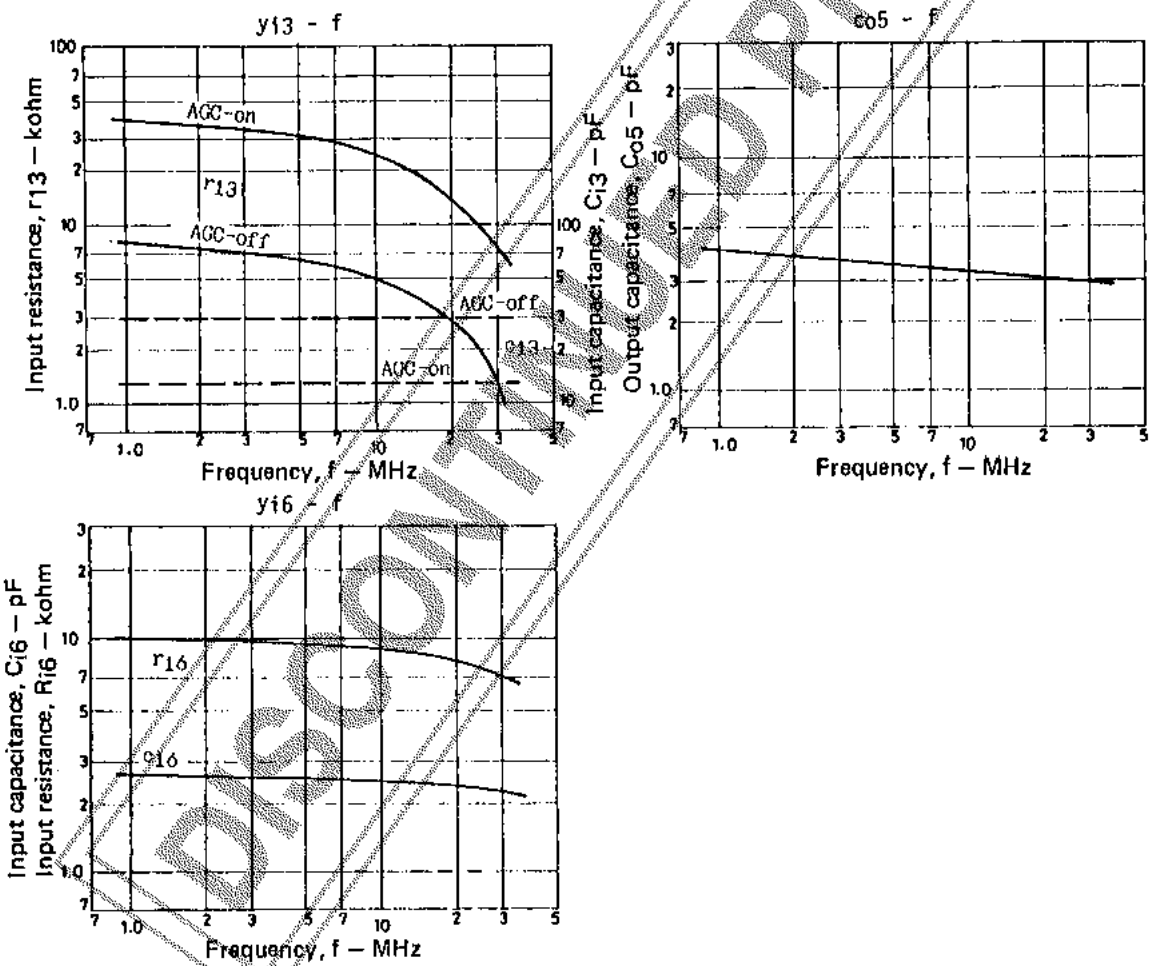

Notes on LA1247 usage

- When suddenly tuned to a broadcasting station of intermediate or high field strength, a large current of high frequency flows into the signal meter circuit, causing the local oscillator malfunctions and abnormal noises. To eliminate this:
 - Use $R_{208} \geq 240$ ohm for manual tuning type.
 - Use $R_{208} \geq 82$ ohm, and use the local oscillation coil at the 1/3 tap (except SW for electronic tuning type (which uses a narrow band filter)).

2. Use the bias on the condition $RF V_{CC} \leq IF V_{CC}$, since abnormal noise levels might be caused when detuning a strong input on the condition $RF V_{CC} \geq IF V_{CC}$
3. Use the signal meter driving output (V_{SM}) at $V_{SM} \leq V_{CC} - 2 (V)$ to avoid saturation caused by V_{CC} .
4. Use 1/2 or more tap of LW and MW oscillation coil to improve S/N and the detuning characteristics of the distortion ratio.
5. Use the full-tap of SW oscillation coil, to allow the sag in oscillation power by the decreasing of Q.
6. Avoid the coupling of the antenna tuning circuit and the local oscillating circuit so as not to leak the local oscillation into the antenna tuning circuit.
7. Connect the detection capacitor C_{113} between pin 13 (output) and pin 14 (V_{CC}) to avoid the leakage of the IF signal into the GND line. Connection between pin 13 and pin 12 (GND) increases the tweet interference and deteriorates the usable sensitivity. Moreover, depending on the positions of C_{113} and the bar antenna, higher harmonics having twice or three times the frequency of the IF signal may pass into the antenna and cause tweet interference in extreme cases oscillation might be caused. To prevent this:
 - Trim lead wires and connect them near 13 and 14 pins.
 - Place C_{113} far from the antenna.
8. When a cable or something similar is connected to a local oscillation buffer (pin 20), which is equivalent to connecting a capacitor of about 20 pF, the output from the buffer will be of sawtooth waves, causing the level low at the short wave band. To prevent this, connect a resistor between pin 20 and GND, which will increase the operating current of the buffer amplifier. Since the maximum current obtained from pin 20 is 2 mA, the suitable resistance between pin 20 and GND is 1.5 kohm.
9. Use a semi-fixed resistor for R_{211} to allow the fluctuation of V_{SM} .
10. When changing an IFT or using an RF tuner, select a filter and related circuits according to the following conditions. The input levels of each terminal where 30% modulated detection output of -25 dB is obtained are as follows:

Pin 11 input	when $R_g = 520 \text{ ohm} (470 \text{ ohm} + 50 \text{ ohm})$	75 dB μ
Pin 9 input	when $R_g = 50 \text{ ohm}$	53 dB μ
Pin 6 input	when $R_g = 50 \text{ ohm}$	48 dB μ
Pin 3 input	when $R_g = 50 \text{ ohm}$	22 dB μ

Slight change in IFT, however, will be covered by changing the constant of resistors R_{202} and R_{204} .

Application 1

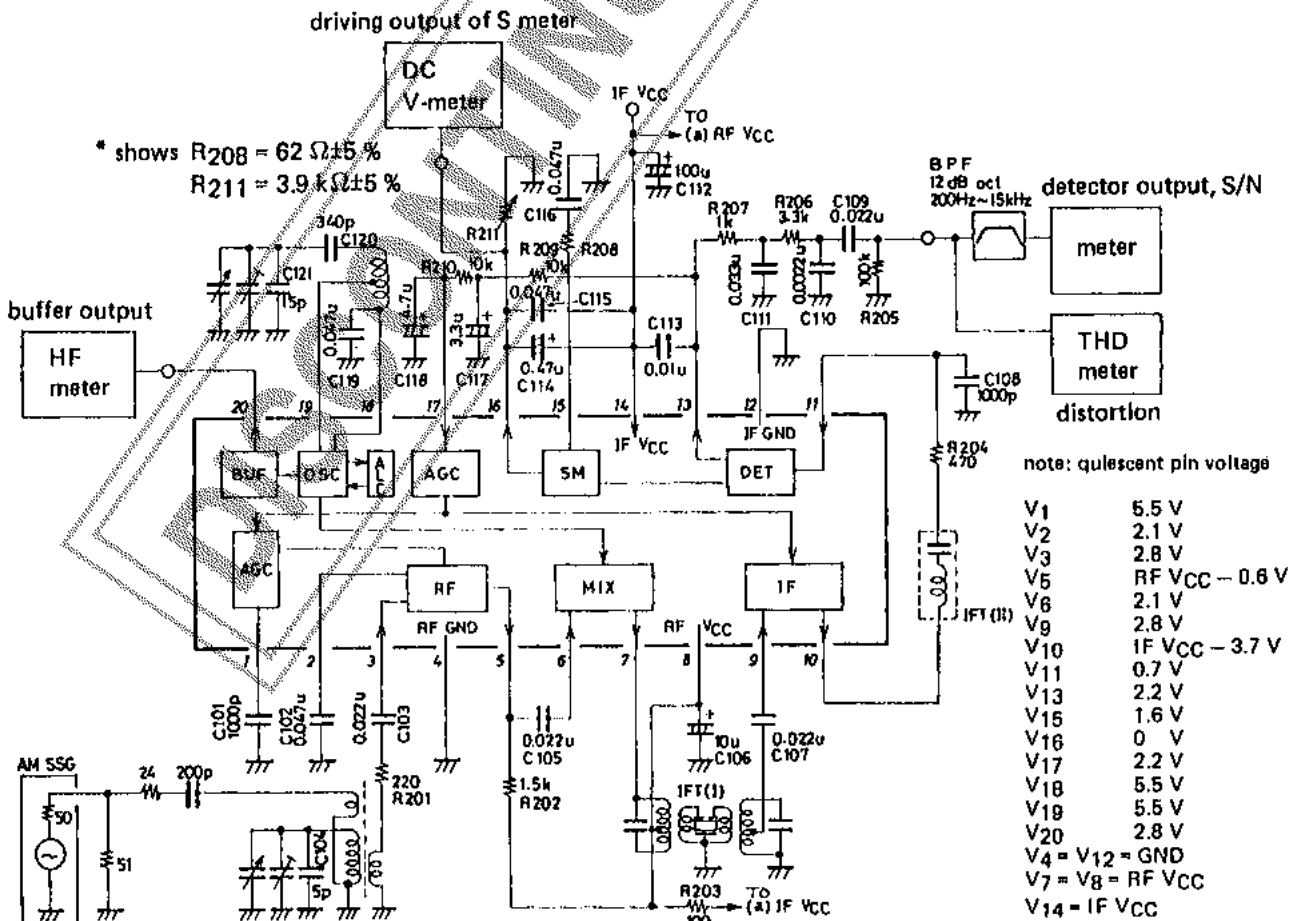

LA1247

□ Subchannel S/N test circuit

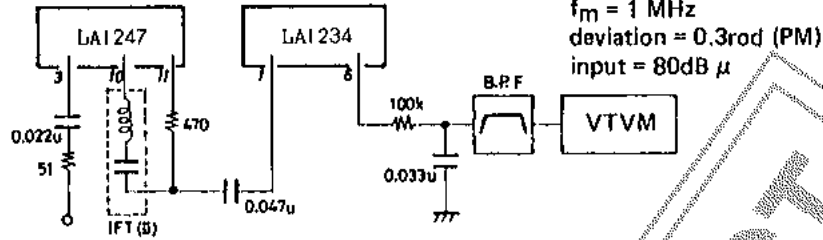

VCC = 12V
 $f_r = 1 \text{ MHz}$
 $f_m = 1 \text{ MHz}$
 deviation = 0.3rod (PM)
 input = 80dB μ

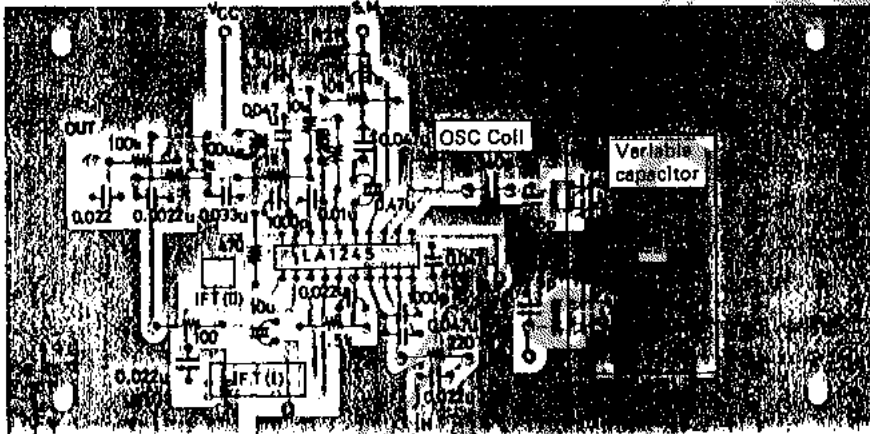

An Example of Printed Pattern (Cu-foild area) (150 x 72 mm²)

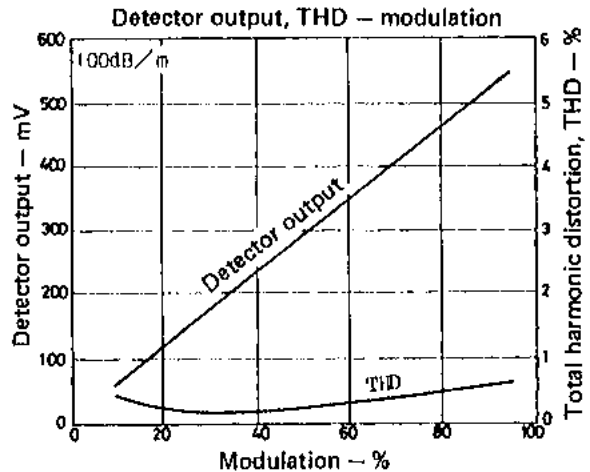
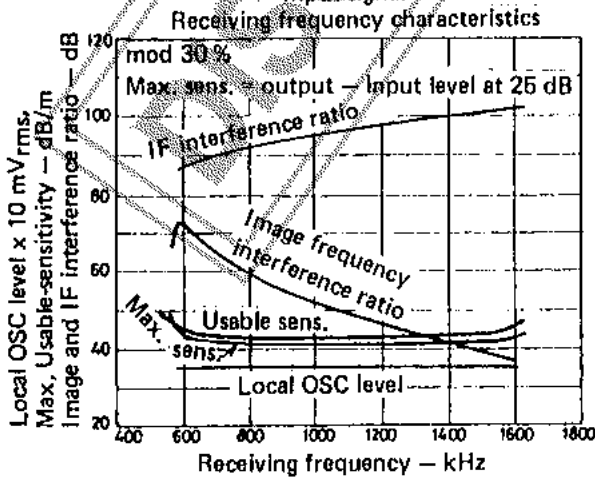
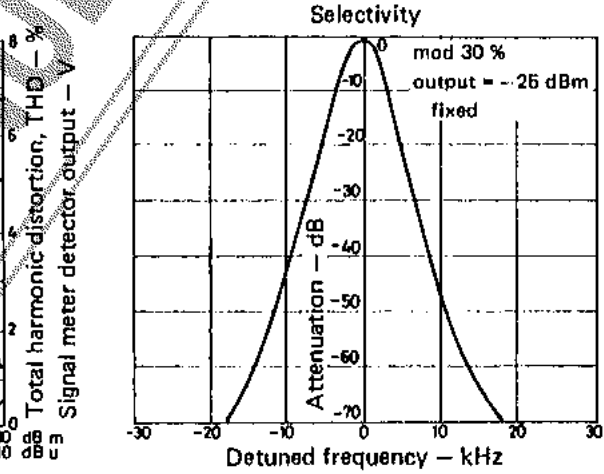
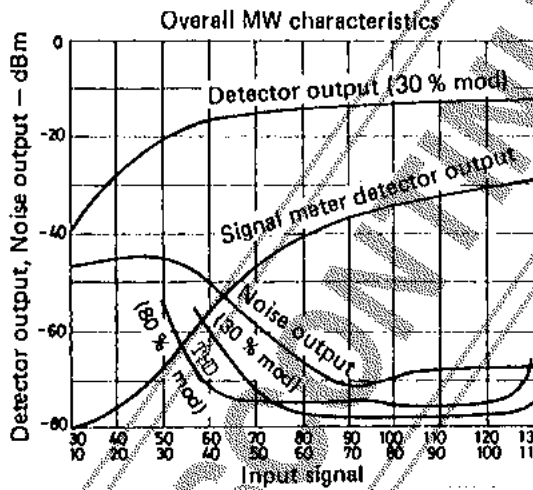

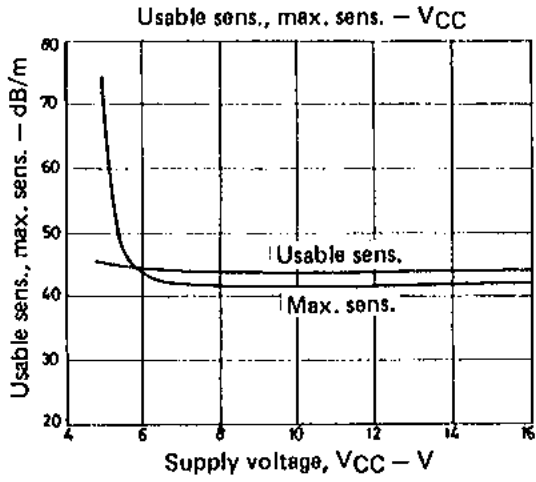
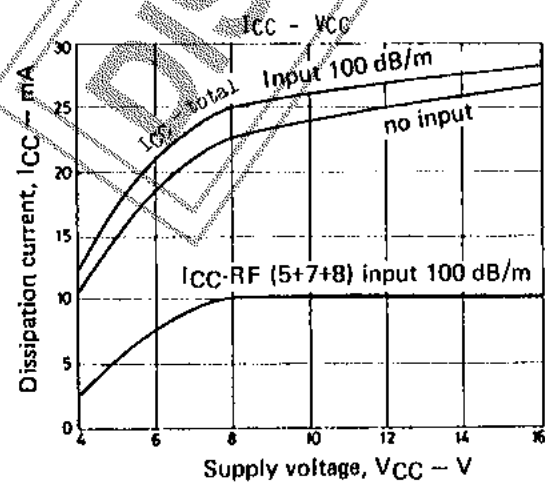
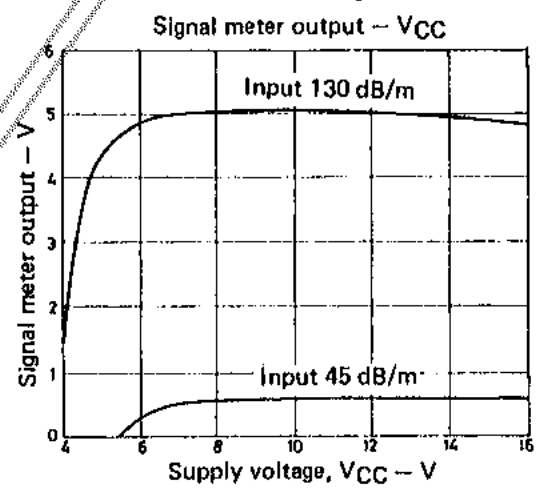
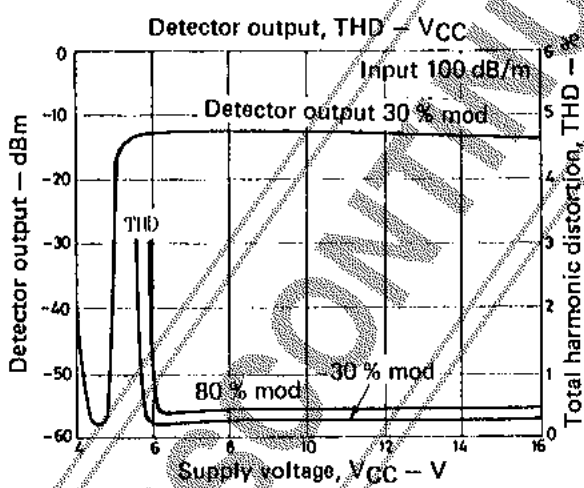
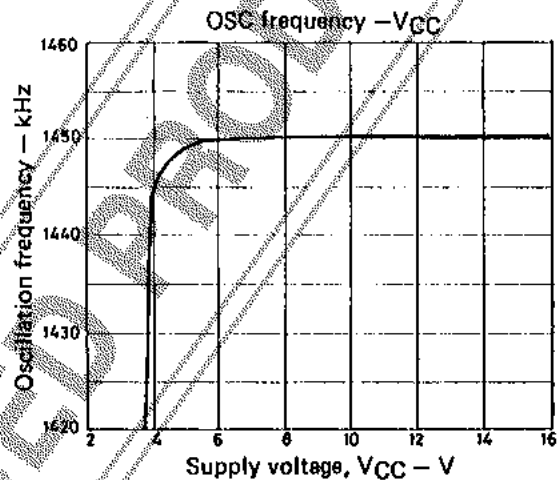
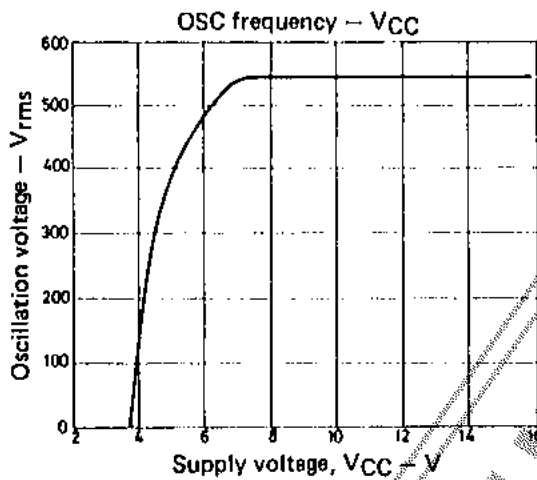
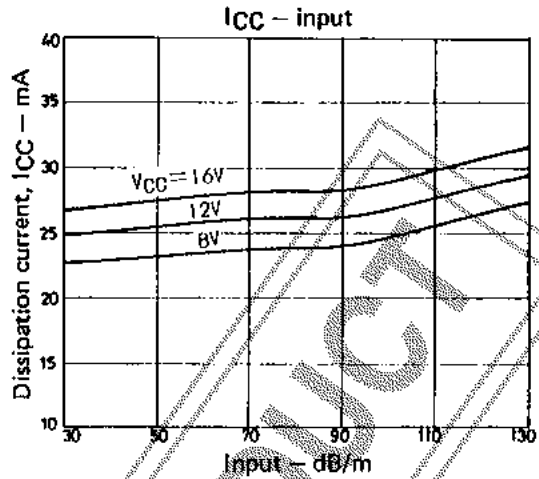
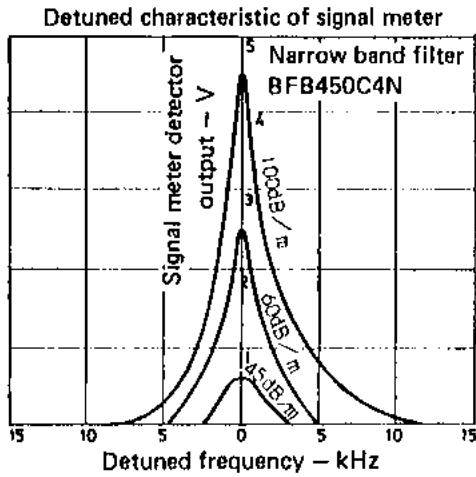

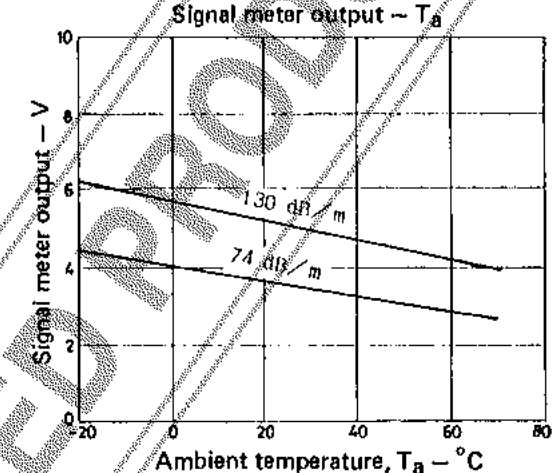
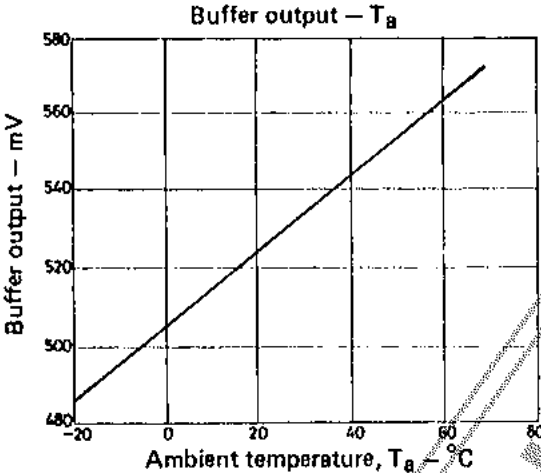
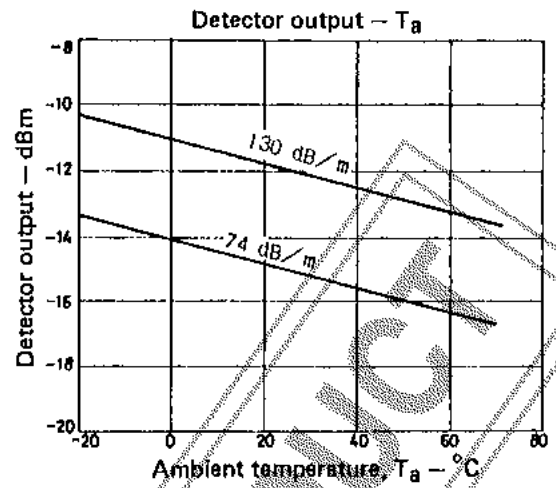
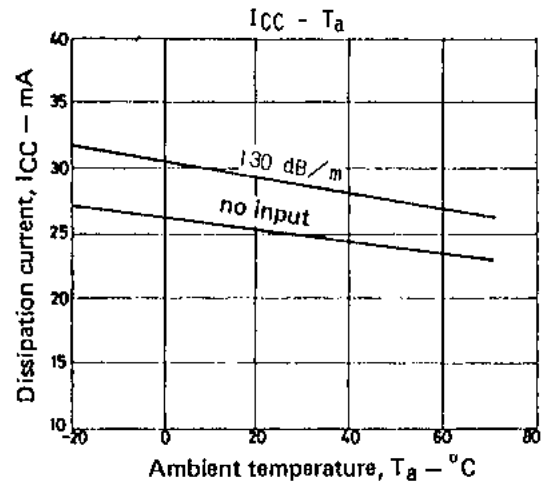

■ Application 2: Using Variable Capacitance Diodes

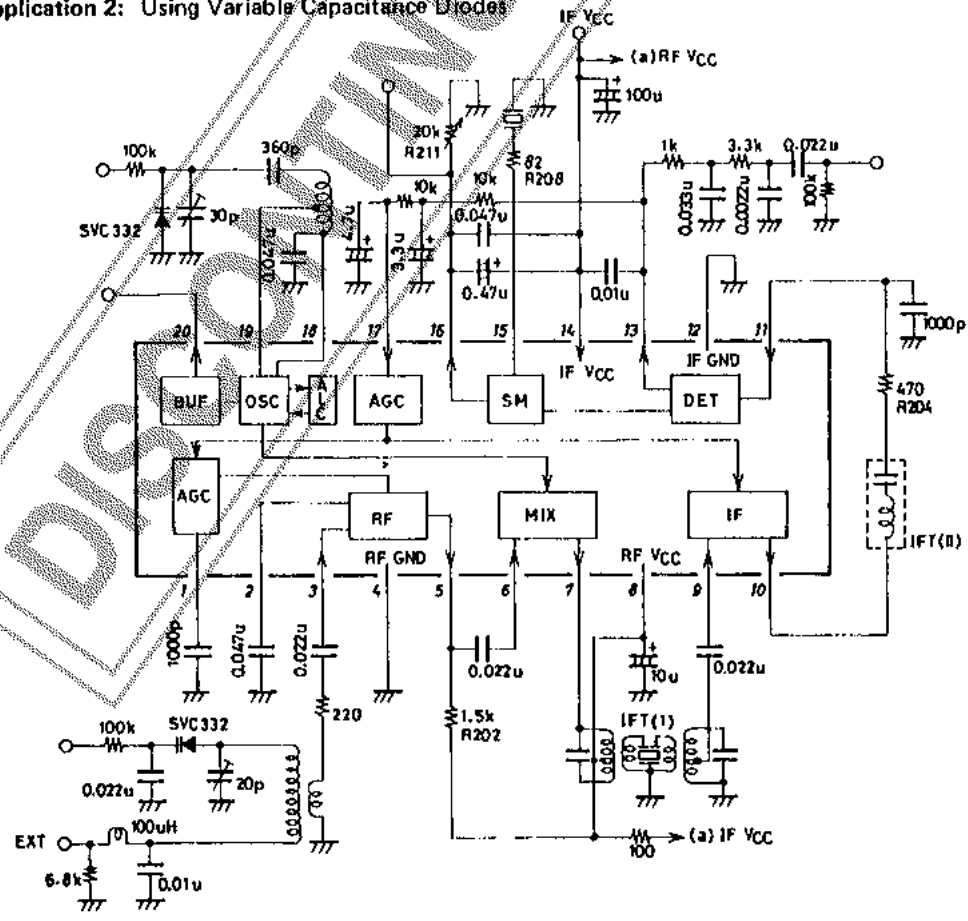

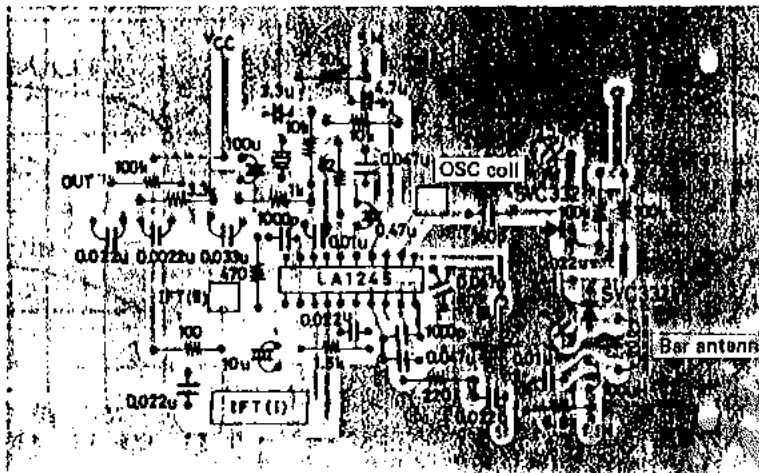

An Example of Printed Pattern (Cu-foil area) (130 x 80 mm)

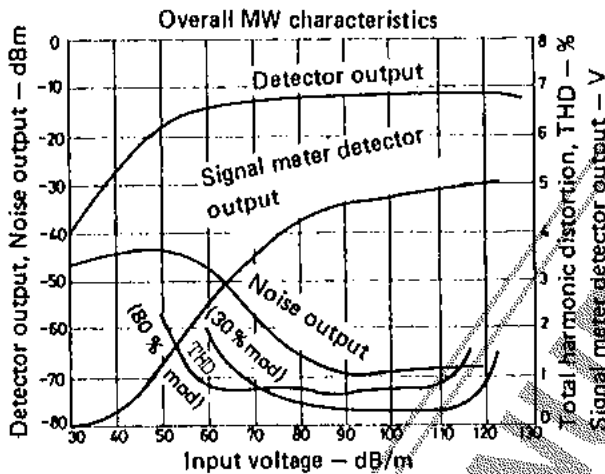

Application 3: Rejecting IFT (II)

Following 2 changes are recommended as C-coupling without IFT (II).

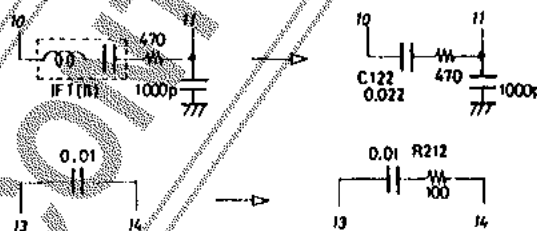

Comparison of characteristics varying parts.

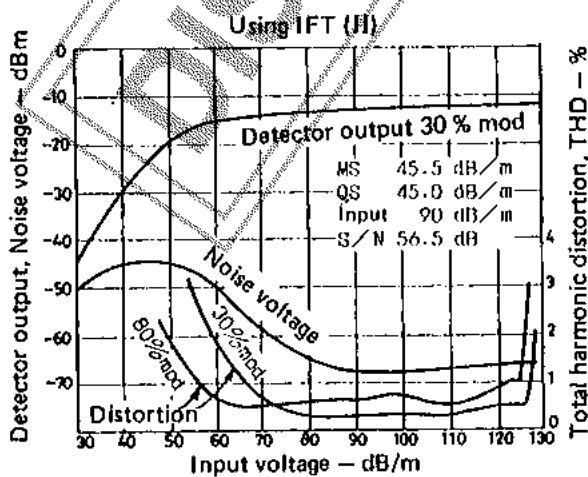

Without IFT (II), C-coupled

$C_{122} = 0.022 \mu F$

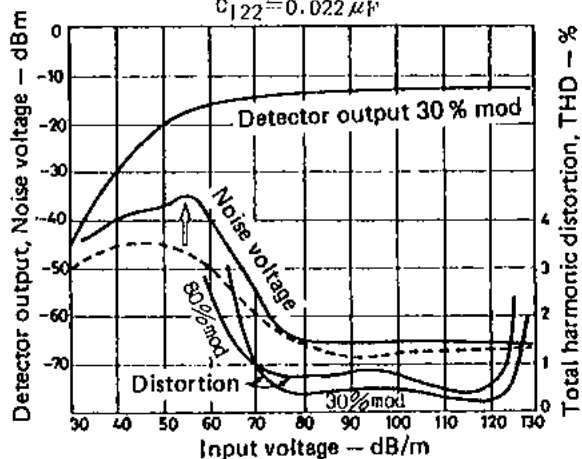

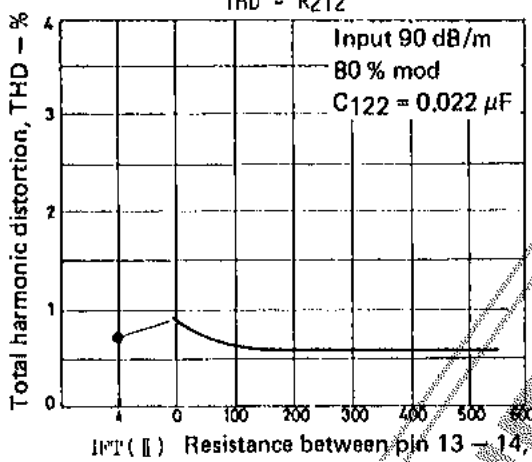
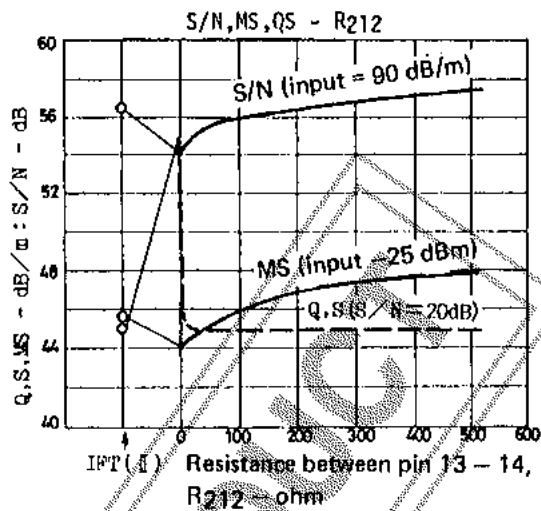
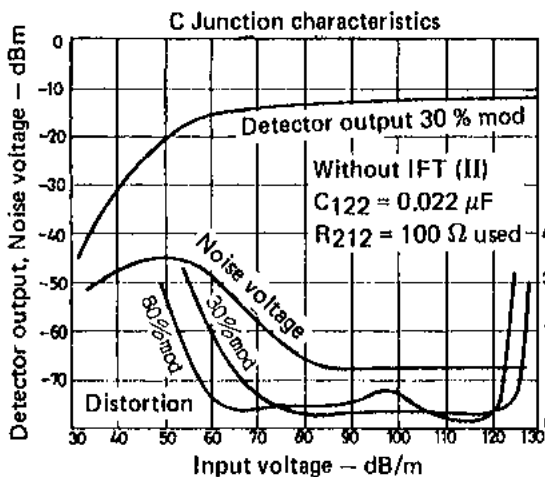

Peripheral Parts

- (1) Bar Antenna (34H-052-869 Sumida Co.)

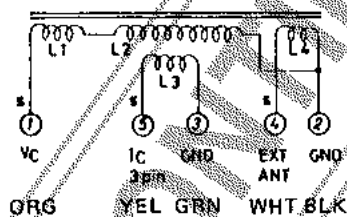

For use of general variable capacitor

- L (between pin 1, 2) = 270 μH
- Q ≥ 180
- L1: solenoid 43 t.
- L2: space 42 t.
- L3: solenoid 7 t.
- L4: solenoid 4 t.

- (2) Bar Antenna (C-4698 Coil Snake Co.,)

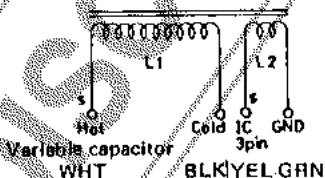

For use of variable capacitor diode

- L (between pin 1, 2) = 250 μH
- Q ≥ 250
- L1: solenoid 55 t.
- L2: solenoid 5 t.

- (3) Osc coil

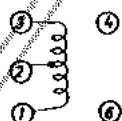

2157-223-072 Sumida

2157-223-082 Sumida

7BR-6654Y Toko

L (between pin 1 and 3) = 147 μH

L (between pin 1 and 3) = 147 μH

L (between pin 1 and 3) = 147 μH

- Q ≥ 85
- 3 - 2 39 t.
- 2 - 1 39 t.

- Q ≥ 85
- 3 - 2 26 t.
- 2 - 1 52 t.

- Q ≥ 90
- 3 - 2 31 t.
- 2 - 1 31 t.

(4) Variable Capacitor (C123A Alps Co.,)

c max 326.8 pF
c min 6.7 pF

(5) Variable Capacitor Diode (SVC332 Sanyo)

(6) IFT (I) (CMFQ-021A Toko Co.,)

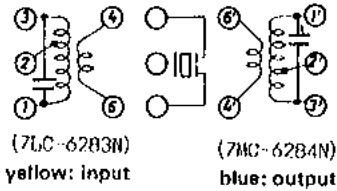

CMFQ-021A

3-2	58 t.	3-2	18 t.
2-1	98 t.	2-1	130 t.
6-4	16 t.	6-4	16 t.
Cent. Freq. 450 kHz		Cent. Freq. 450 kHz	
Qu = 70 + 20%		Qu = 110	
Tuned Cap. 180 pF		Tuned Cap. 180 pF	

(7) IFT (II)

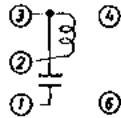

2150-208-033 Sumida Co.,
Cent. Freq. 455 kHz
 $Q \geq 95$
between 2 and 3 170 t.
Tuned Cap. 180 pF
2150-208-033 Sumida Co.,

7LC-4751B Toko Co.,
Cent. Freq. 455 kHz
 $Q \geq 75$
between 2 and 3 146 t.
Tuned Cap. 180 pF
7LC-4751B Toko Co.,

(8) Narrow Band Resonator (BFB450C4 N Murata Co.,)

