

LA1810 — AM/FM/MPX Tuner System for Radio-Cassette Recorders, Music Centers

Functions

- FM-IF : IF amp, quadrature detector, soft muting, tuning indicator.
- MPX : PLL stereo decoder, stereo indicator, forced monaural, VCO stop.
- AM : RF amp, MIX, OSC (with ALC), IF amp, detector, AGC, tuning indicator.

Features

- FM/AM/MPX functions contained on a single chip.
- Minimum number of external parts required.
- On-chip FM muting function.
- High sensitivity.
- Less carrier leak of MPX.

Package Dimensions

(unit : mm)
3067-DIP24S

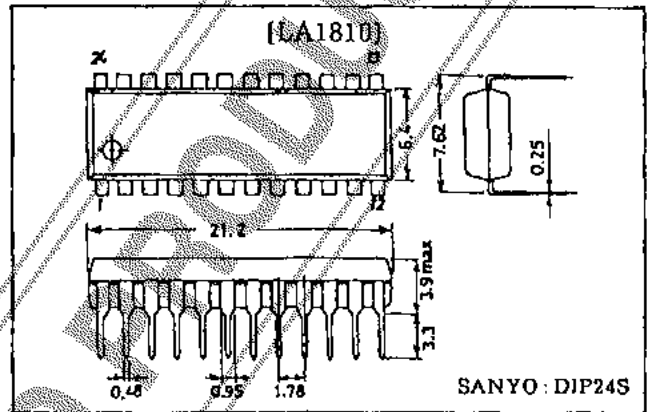

Specifications

Maximum Ratings at $T_a = 25^\circ\text{C}$, See specified Test Circuit.

			Unit
Maximum Supply Voltage	$V_{CC \text{ max}}$	3, 7, 8, 11, 20, 21	9 V
Maximum Supply Current	$I_{CC \text{ max}}$	3 + 20 + 21	50 mA
Flow-in Current (Indicator Drive Current)	I_{ED}	7, 8	20 mA
Flow-out Current	I_{zj}	23	0.1 mA
Allowable Power Dissipation	$P_d \text{ max}$	$T_a \leq 70^\circ\text{C}$	500 mW
Operating Temperature	T_{opr}	-20 to +70	$^\circ\text{C}$
Storage Temperature	T_{stg}	-40 to +125	$^\circ\text{C}$

Operating Conditions at $T_a = 25^\circ\text{C}$

			Unit
Recommended Operating Voltage	V_{CC}	4.5	V
Operating Voltage Range	$V_{CC \text{ op}}$	3.0 to 8.0	V

* The FM output level forms an N curve (LA1810) and an S curve (LA1811).

LA1810: N curve (for US band)

LA1811: S curve (for Japan band). Your desired output level can be set by varying the output resistance.

Operating Characteristics at $T_a = 25^\circ\text{C}$, $V_{CC} 4.5\text{V}$, See specified Test Circuit.

FM Characteristic (Mono)	$f_c = 10.7\text{MHz}$, $f_m = 1\text{kHz}$	min	typ	max	Unit
Quiescent Current	I_{cc} No input		13	20	mA
-3dB Sensitivity	-3dBLS. Referenced to $V_{IN} = 100\text{dB}\mu$, 100%, down 3dB		28	35	dB μ
Demodulation Output	V_o $V_{IN} = 100\text{dB}\mu$, 100 mod.	150	220	300	mV
Channel Balance	C.B. $V_{IN} = 100\text{dB}\mu$, 100 mod.	0	0	1.5	dB

Continued on next page.

How to use the LA1810

1. Forced monaural mode

Fig.1 shows how to cause the forced monaural mode to be entered.

- ① Connect pin 14 to V_{CC} through a resistor of 100kΩ (Turn ON the SW1 in Fig.1).
- ② Connect pin 15 to GND through a resistor of 47kΩ (Turn ON the SW2 in Fig.2).

Either above-mentioned ① or ② causes the forced monaural mode to be entered. In this case, the VCO does not stop operating. If the resistance of R1 and R2 is decreased, internal bias will vary and the VCO frequency will vary when the S1 or S2 is turned ON. This data is shown in Fig.2.

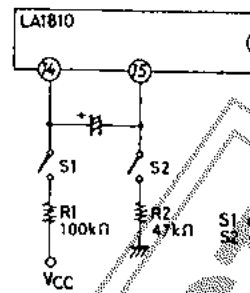
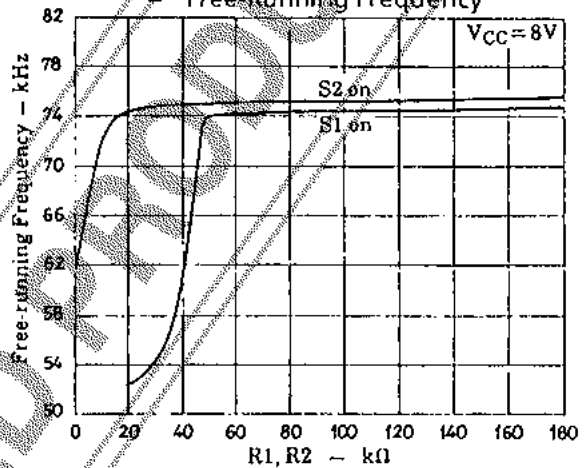

Fig.1 Forced Monaural Mode Setting Method

Fig.2 Forced Monaural Mode Setting Resistance - Free-Running Frequency



2. VCO stop

There is no pin available for stopping the VCO at the FM mode. However, the method shown right can be used to stop the VCO at the FM mode, causing the forced monaural mode to be entered.

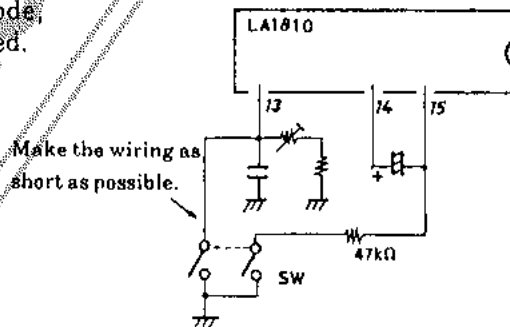

3. Free-running frequency measurement and adjustment

Either of the following two methods is used to measure the free-running frequency.

- 1) Connect pin 13 to a frequency counter through a high input impedance amplifier.

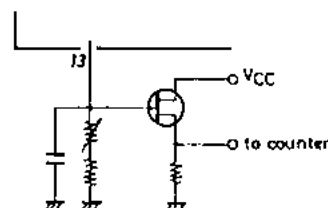

- 2) Connect the connection point of the semifixed resistor connected to pin 13 and the fixed resistor to a frequency counter through a resistor of 240kΩ or greater.

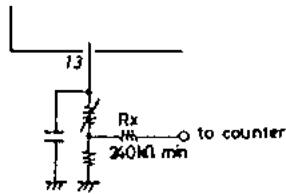

How the error changes with the resistor value is shown right.

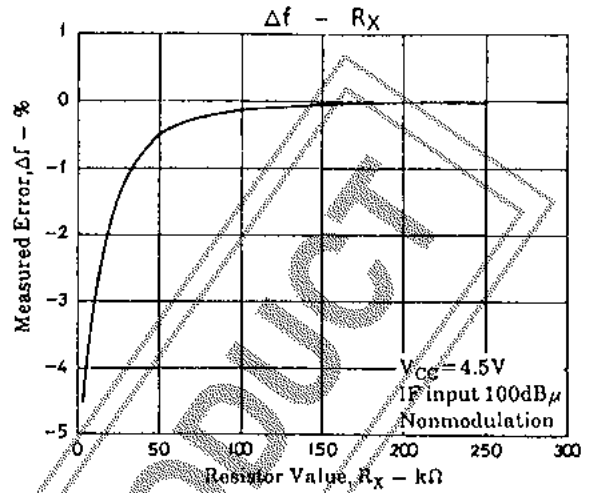

When setting the free-running frequency, the following must be noted. Apply a 10.7MHz $100dB\mu$ nonmodulation carrier as IF input signal and set to $76kHz \pm 50Hz$ with the tuning indicator lighted.

4. Separation setting capacitor C_s

The separation characteristic for the LA1810 alone (IF input) differs from that for the antenna input with a front end. This difference is caused by the characteristics of the front end and ceramic filter. Shown right is how the separation setting capacitor value affects the separation characteristic when the LA1186N is used as front end. Referring to this separation characteristic, choose the optimum separation for your set model.

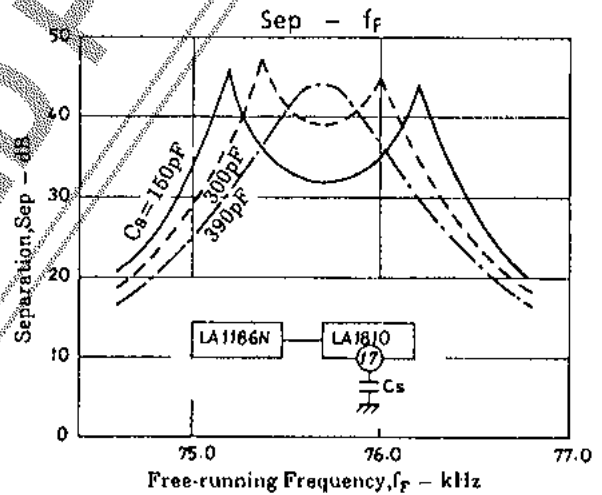

5. A lag-lead filter can be connected across pin 11 and V_{CC} , as shown right, to improve the stereo distortion at low frequencies.

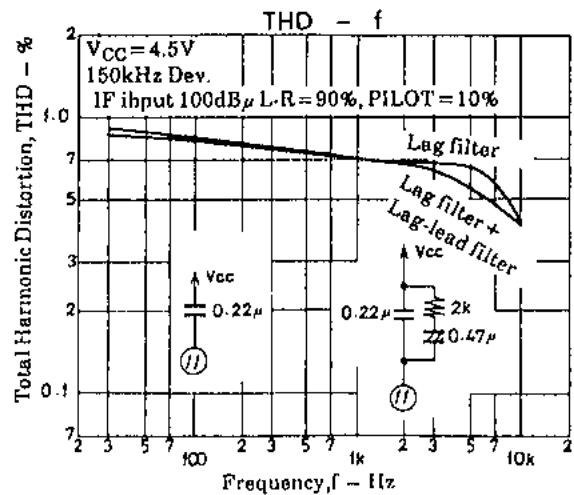

Unit (resistance : Ω , capacitance : F)

6. FM muting pin

The external resistor connected to pin 12 can be used to vary the muting level (Fig.1). The abnormal sound at the time of side peak reception at the FM mode can be reduced by weak signal muting.

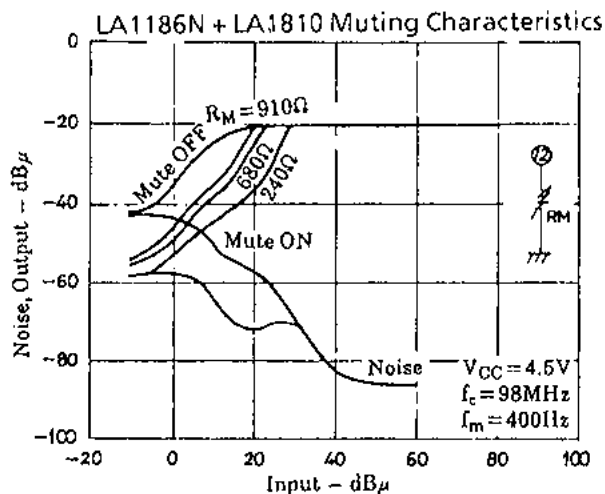

LA1186N + LA1810 Attenuation - Detuning Frequency

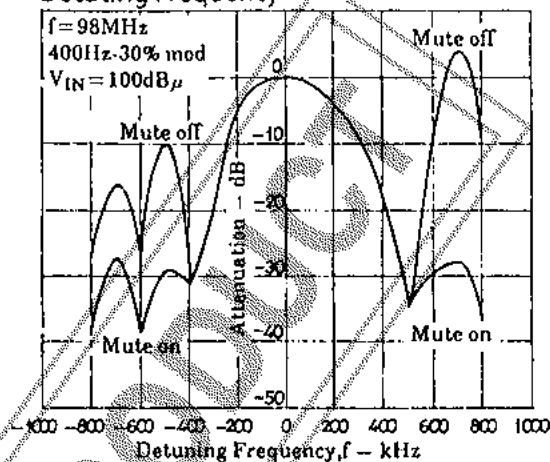

7. The following method can be used to change the LED ON sensitivity at the FM mode (Fig.1). The data on the LED ON sensitivity setting resistance and LED ON sensitivity is shown in Fig.2.

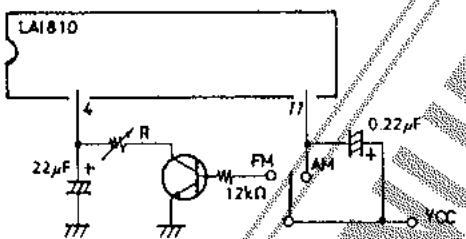

Fig.1 Method to Change the LED ON Sensitivity at the FM Mode

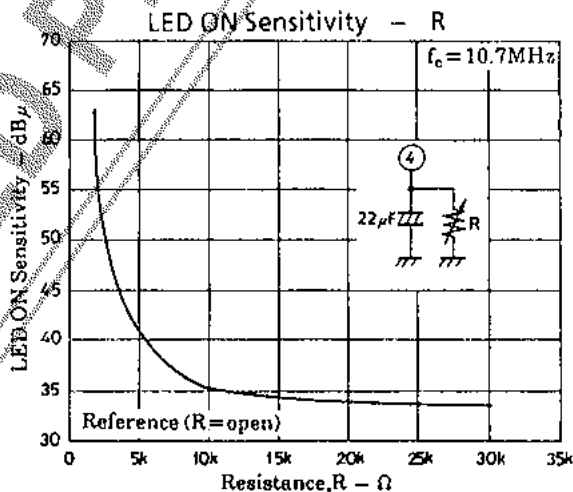
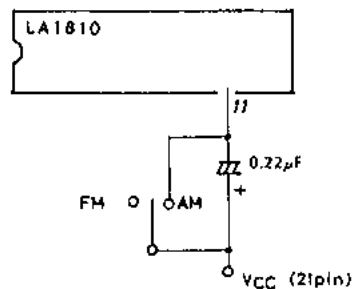

Fig.2 LED ON Sensitivity Setting Resistance - LED ON Sensitivity

8. AM-FM selection

The FM mode is entered with pin 11 open as shown right. When pin 11 and pin 21 are made to be at the same potential in terms of DC, the AM mode is entered. It should be noted that the dynamic range is narrowed whether the potential at pin 22 is lower or higher than that at pin 21.



9. If a noise appears in the detection output when the tuning LED goes ON at the AM mode, connect a capacitor across pin 8 and GND to eliminate the noise.

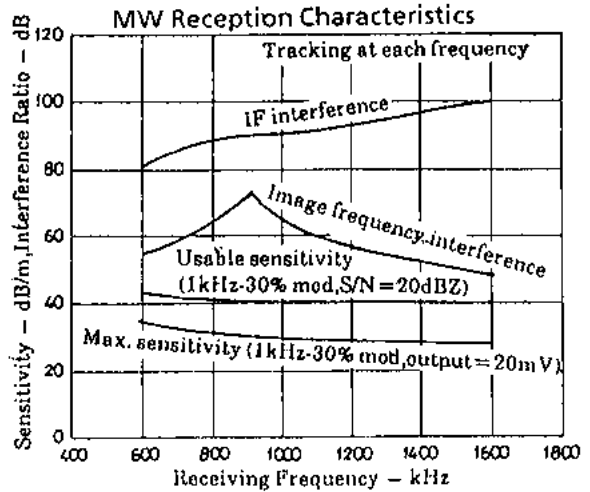
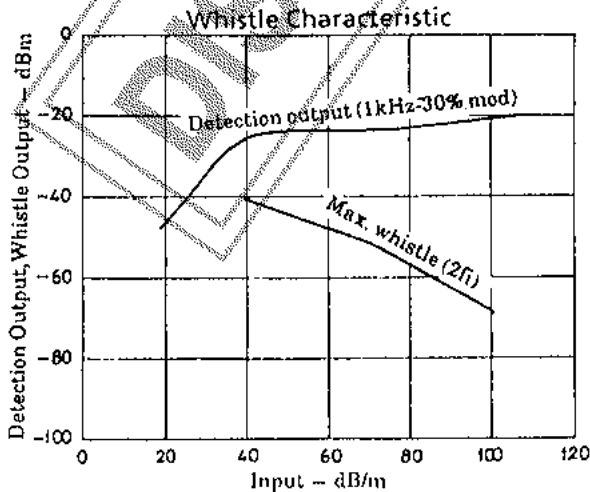
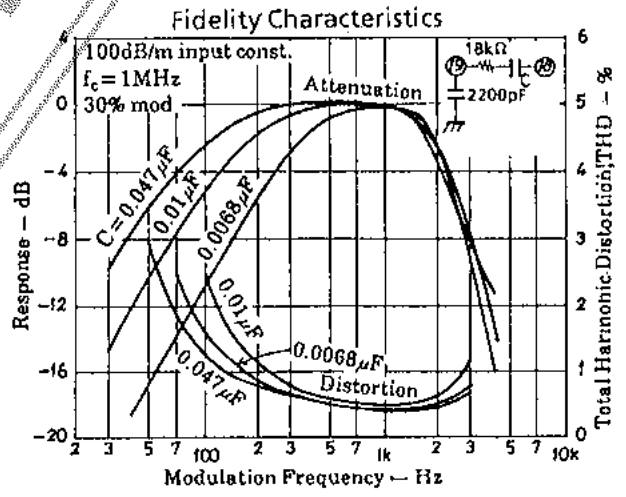
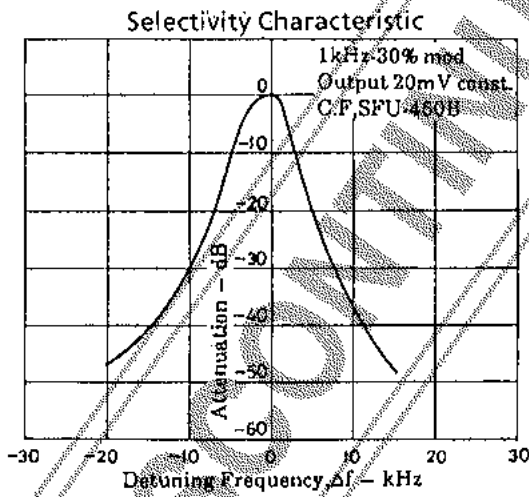
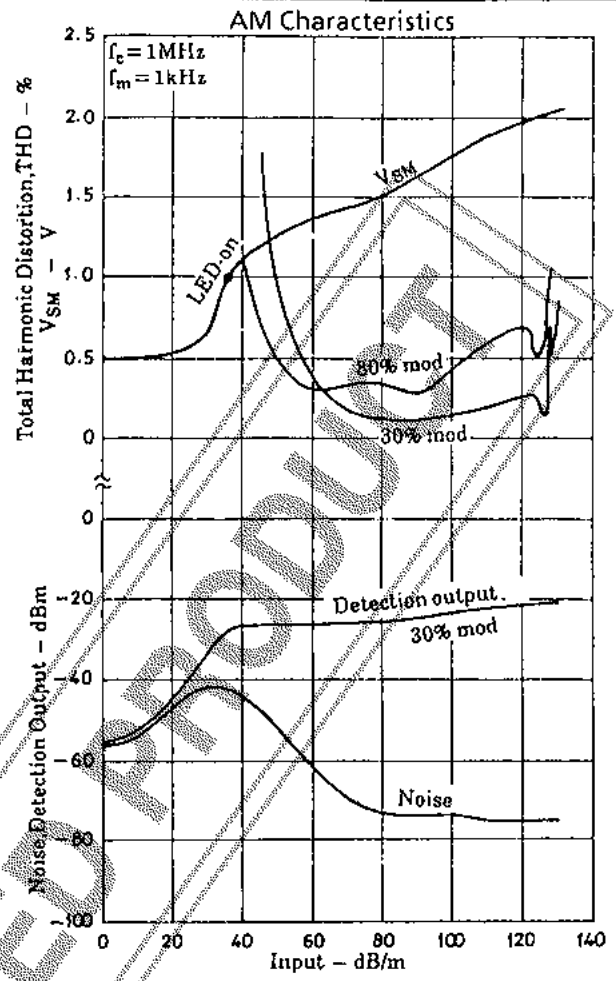
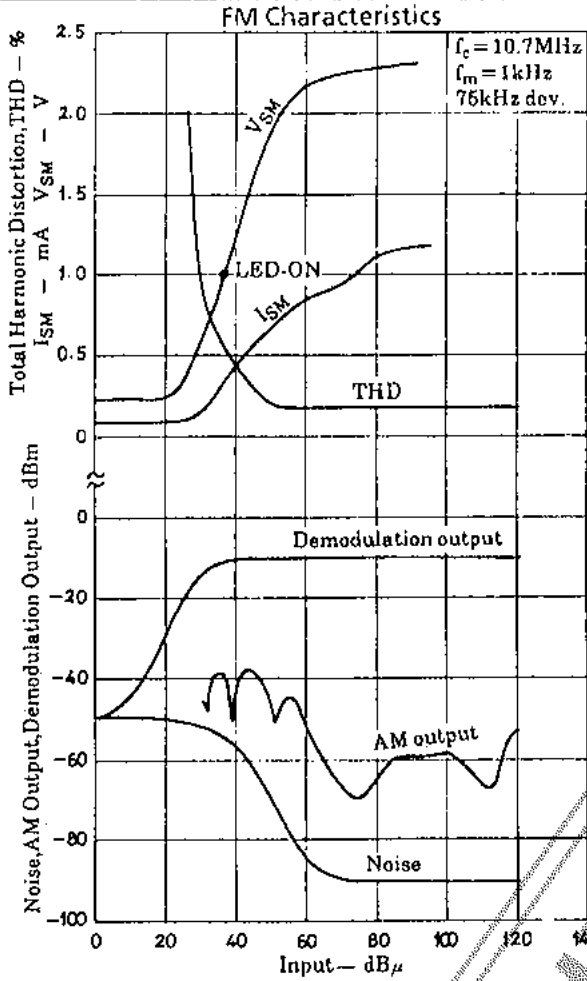

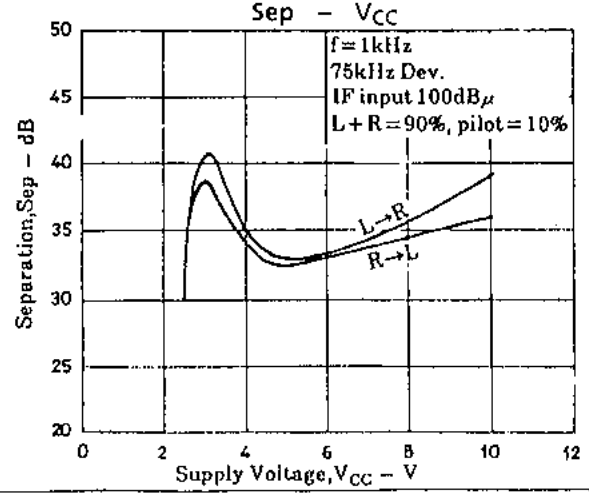
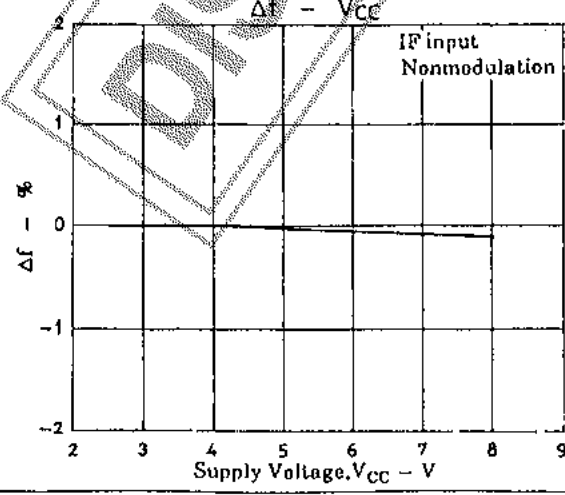
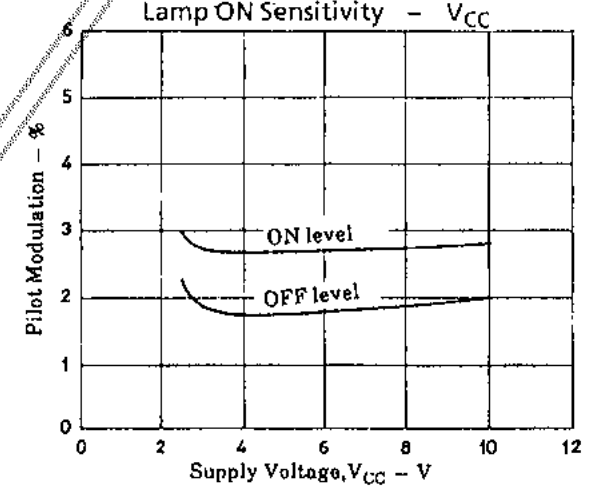
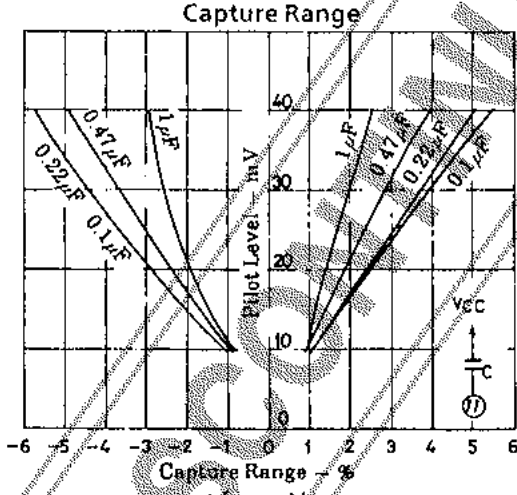
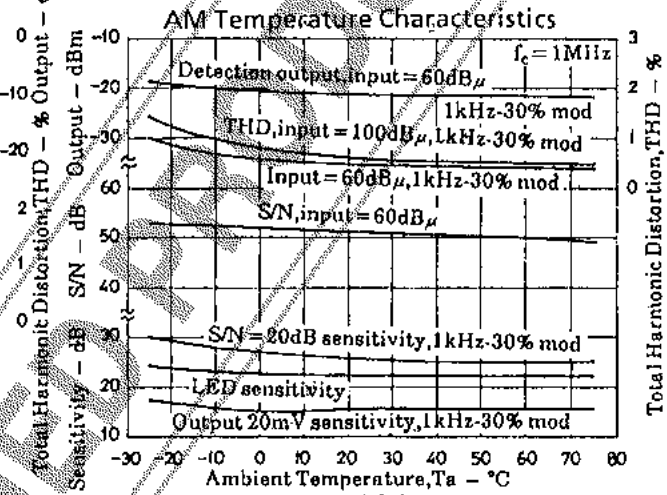
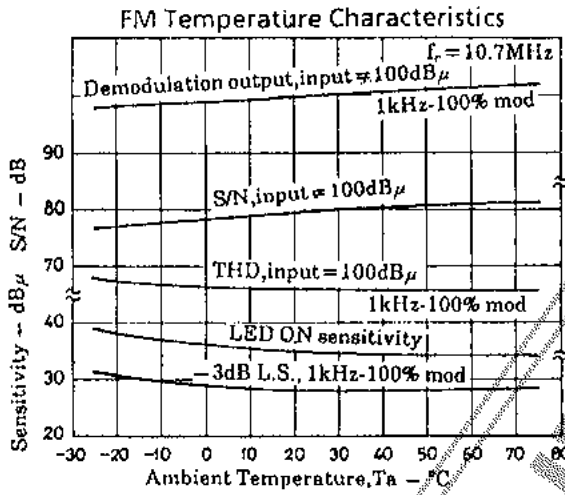
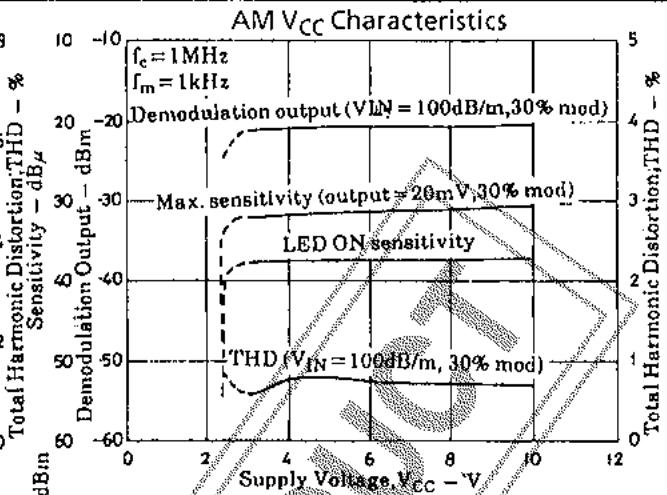
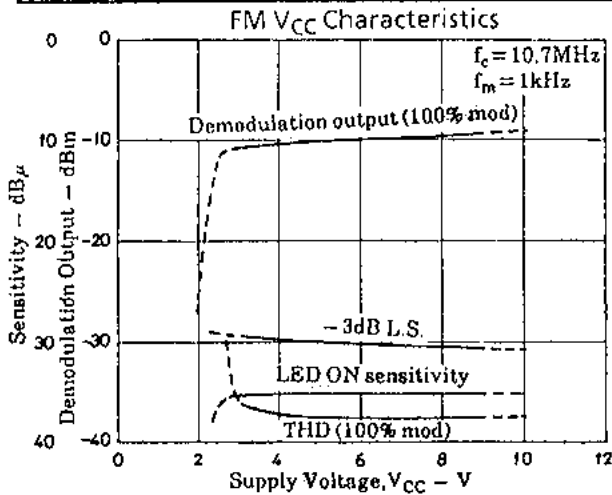

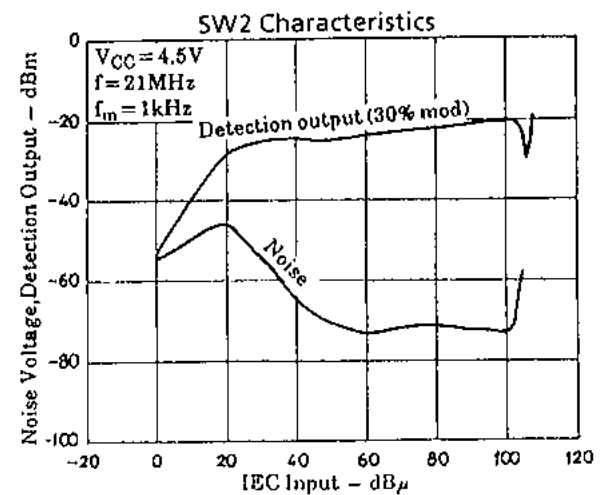
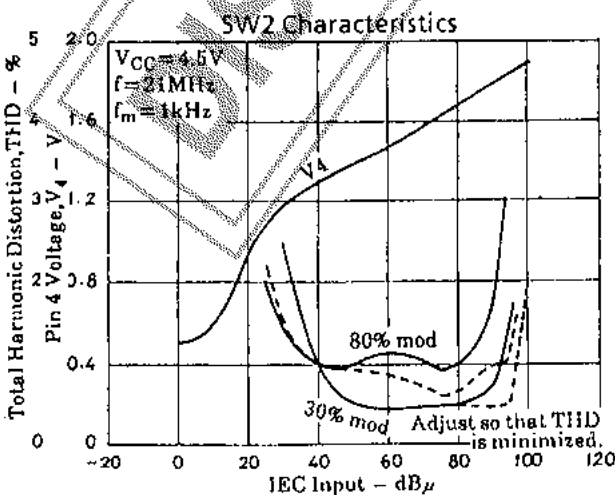
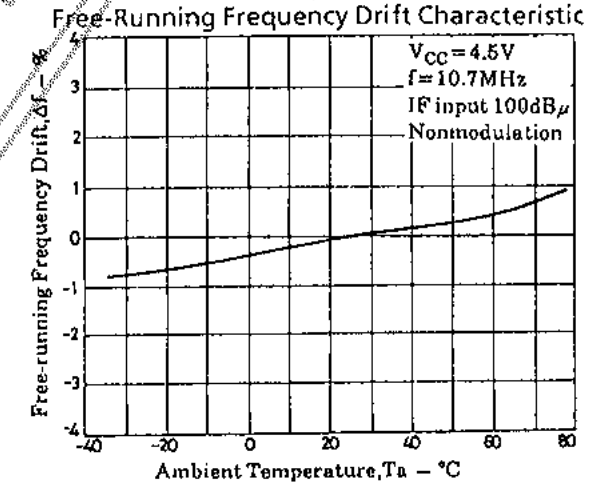
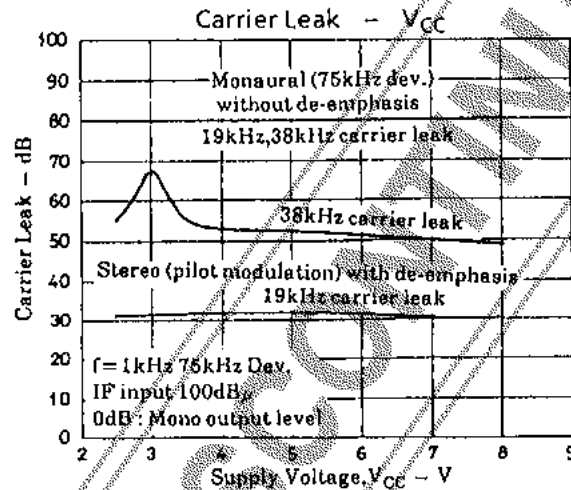
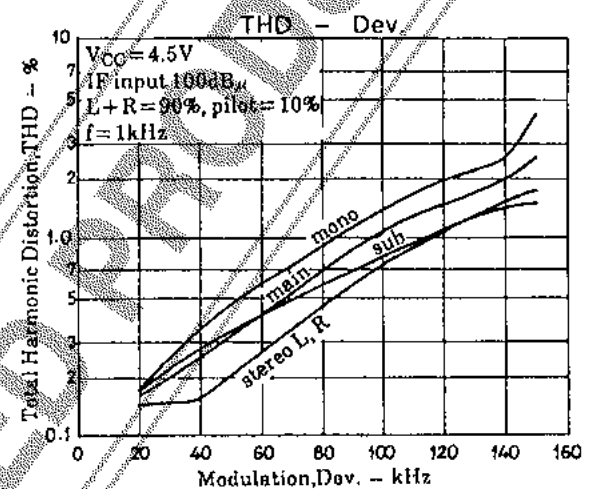
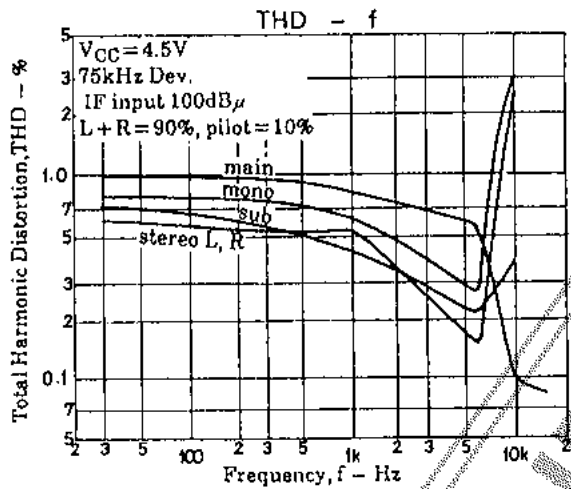
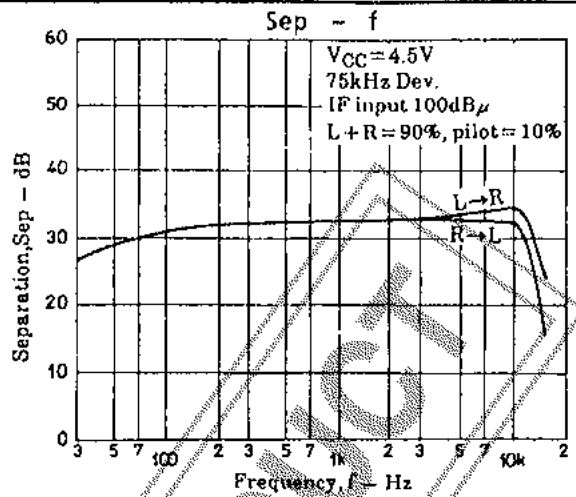
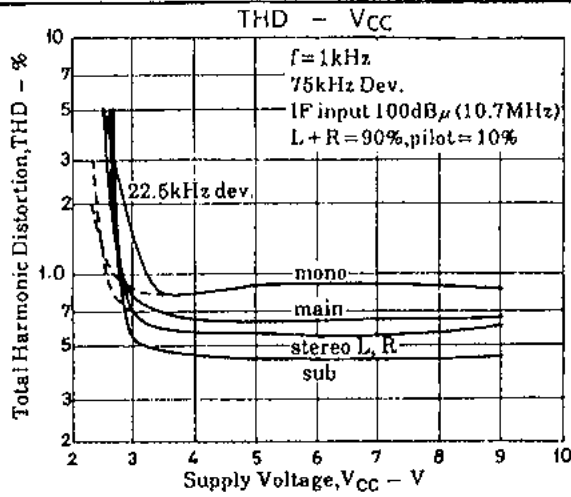

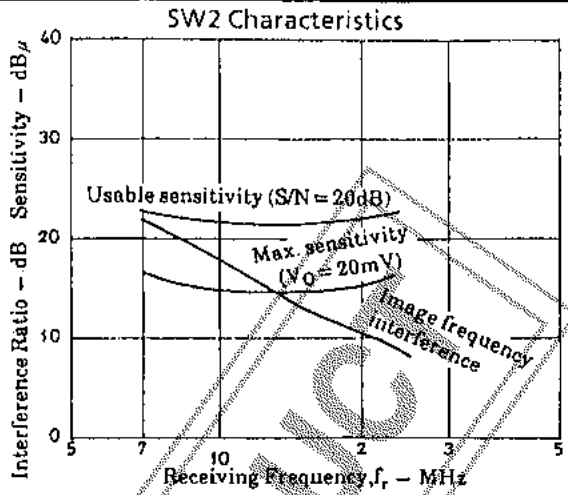
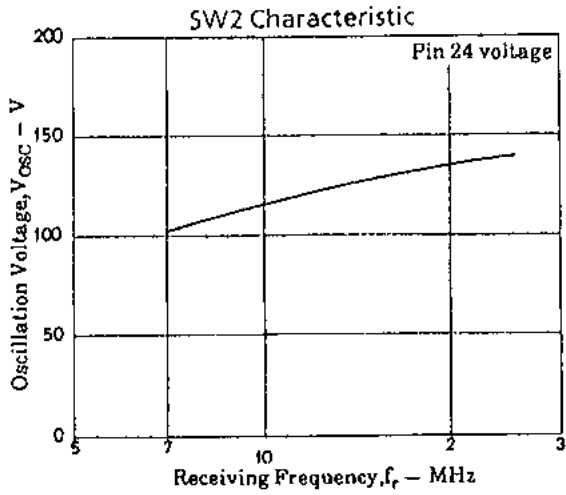

SW Band Test Circuit

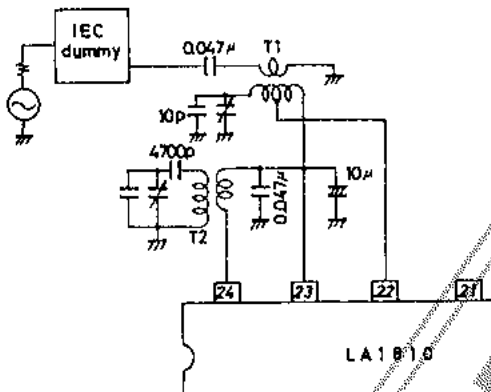

Unit (capacitance: F)

T1: YT-30147 (Mitsumi), 2158-4095-319A (Sumida)
T2: HW-40184 (Mitsumi), 0237-1500 (Sumida)

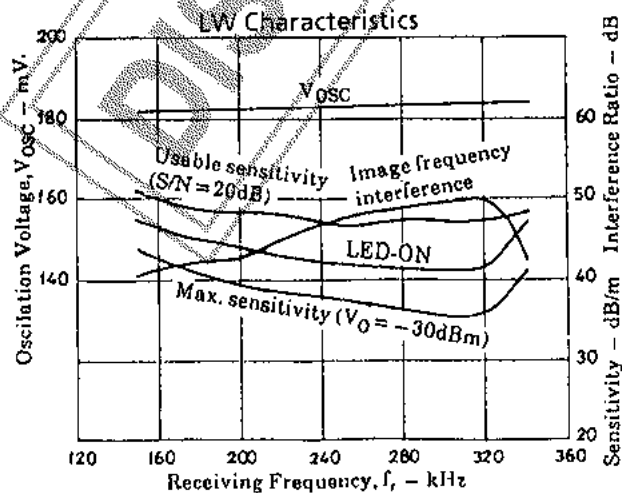
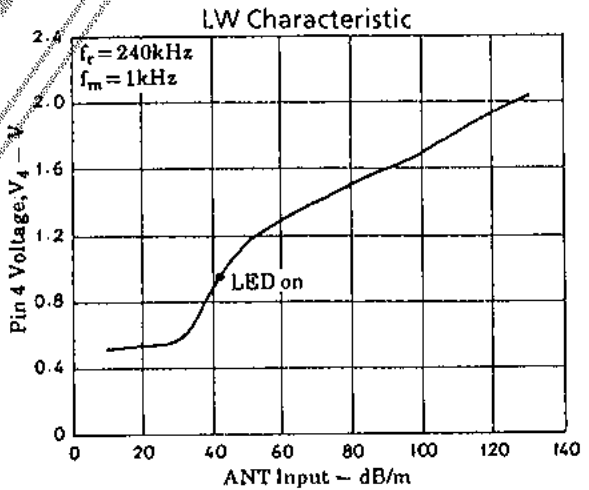
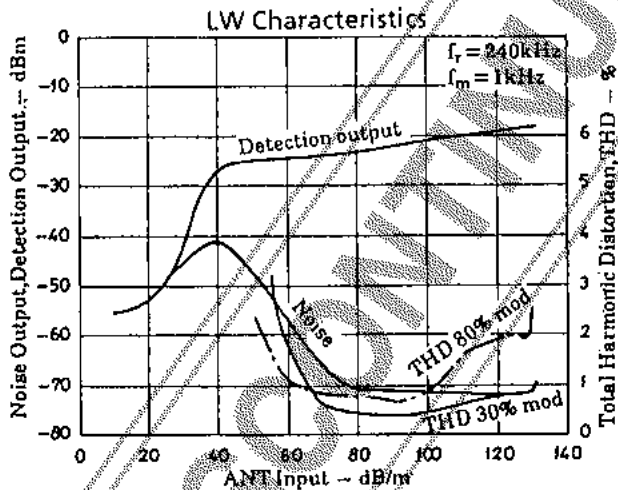

LW Band Test Circuit

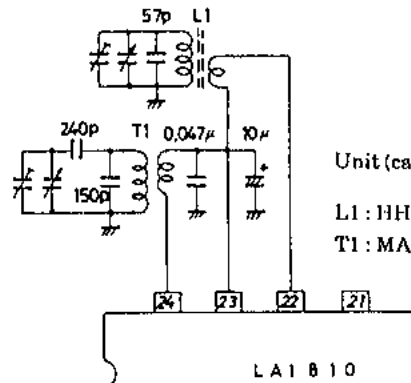

Unit (capacitance: F)

L1: HH-50161 (Mitsumi)
T1: MA-7014 (Mitsumi)

LA1810

Sample Application Circuit : LA1186N + LA1810 FM/MW

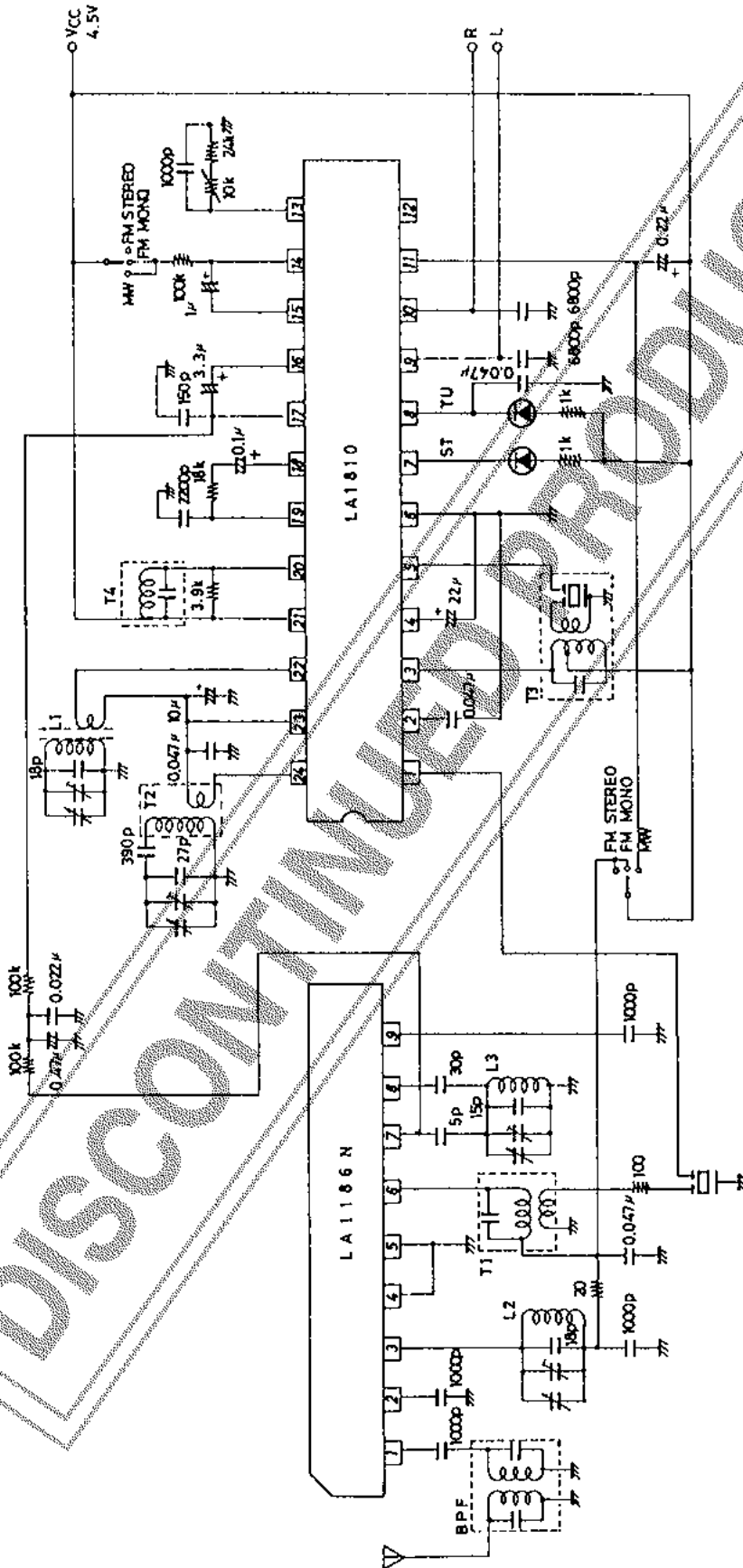

- L1 : TN-10896 (Mitsumi)
- L2 : YT-30196 (Mitsumi)
- L3 : YT-40001 (Mitsumi)
- L4 : YF-39224 (Mitsumi)
- T1 : YF-39224 (Mitsumi)
- T2 : HW-6196 (Mitsumi)
- T3 : HW-6215 (Mitsumi)
- T4 : YF-30103 (Mitsumi)

Unit (resistance : Ω , capacitance : F)

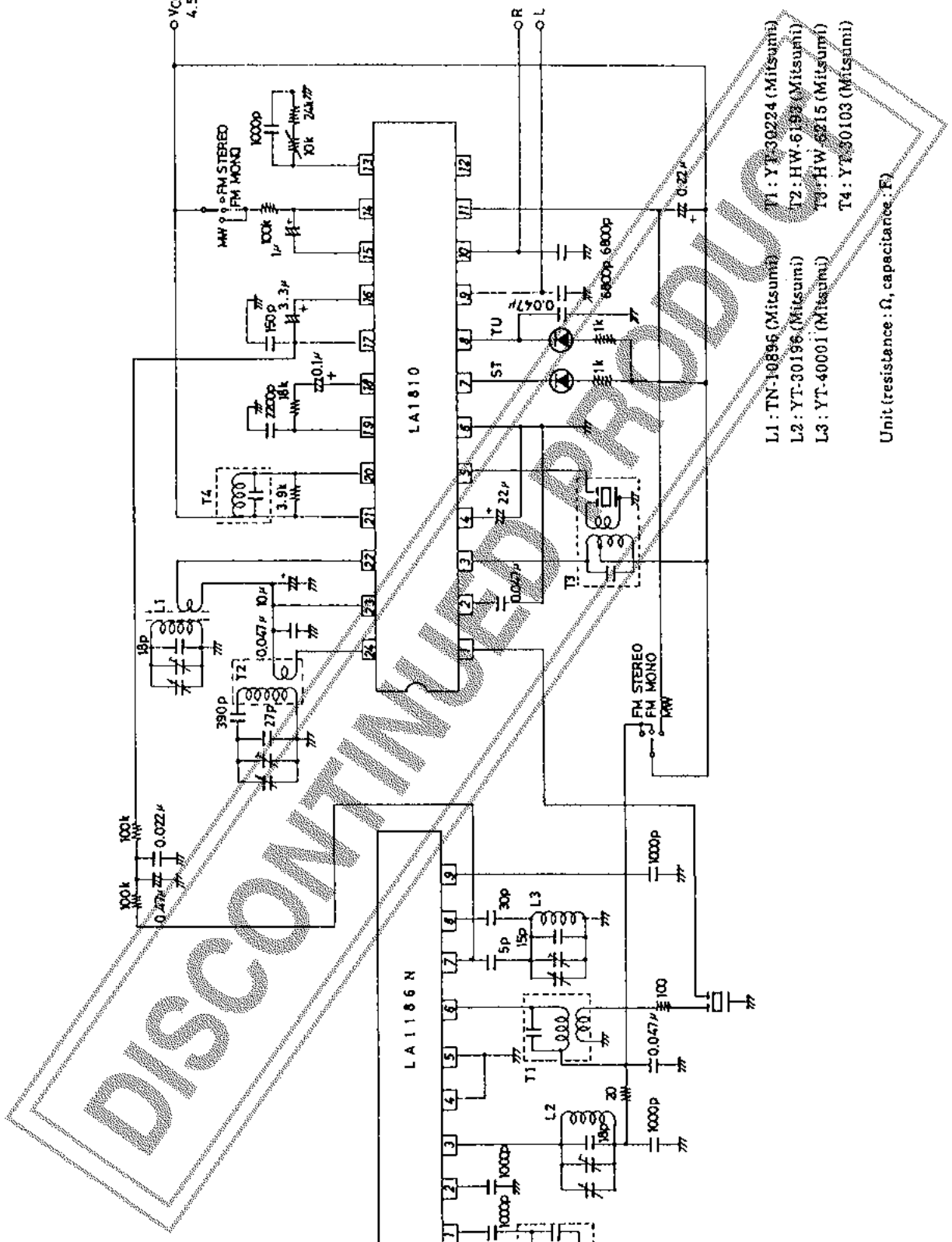

LA1810

Sample Printed Circuit Pattern (See Sample Application Circuit).

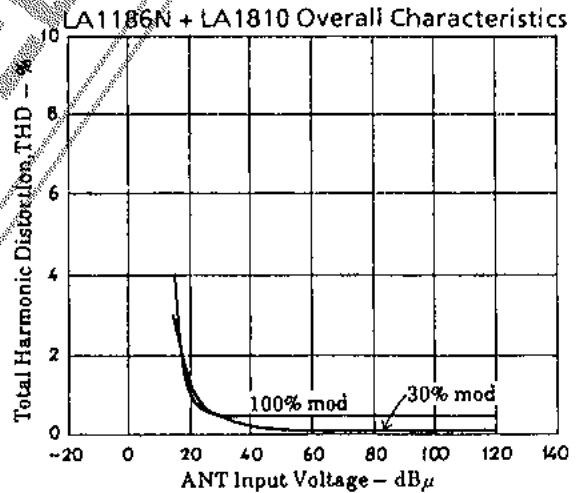
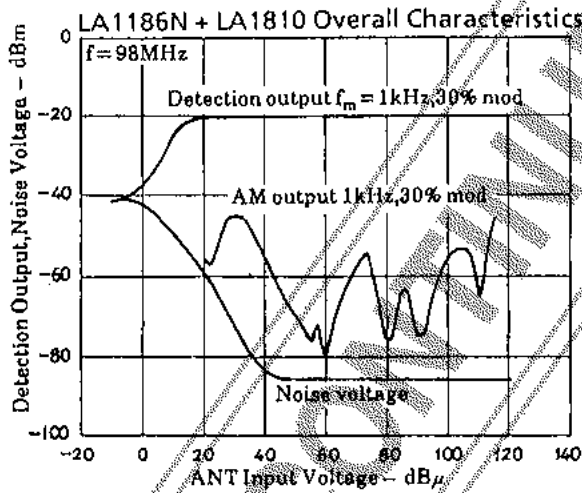
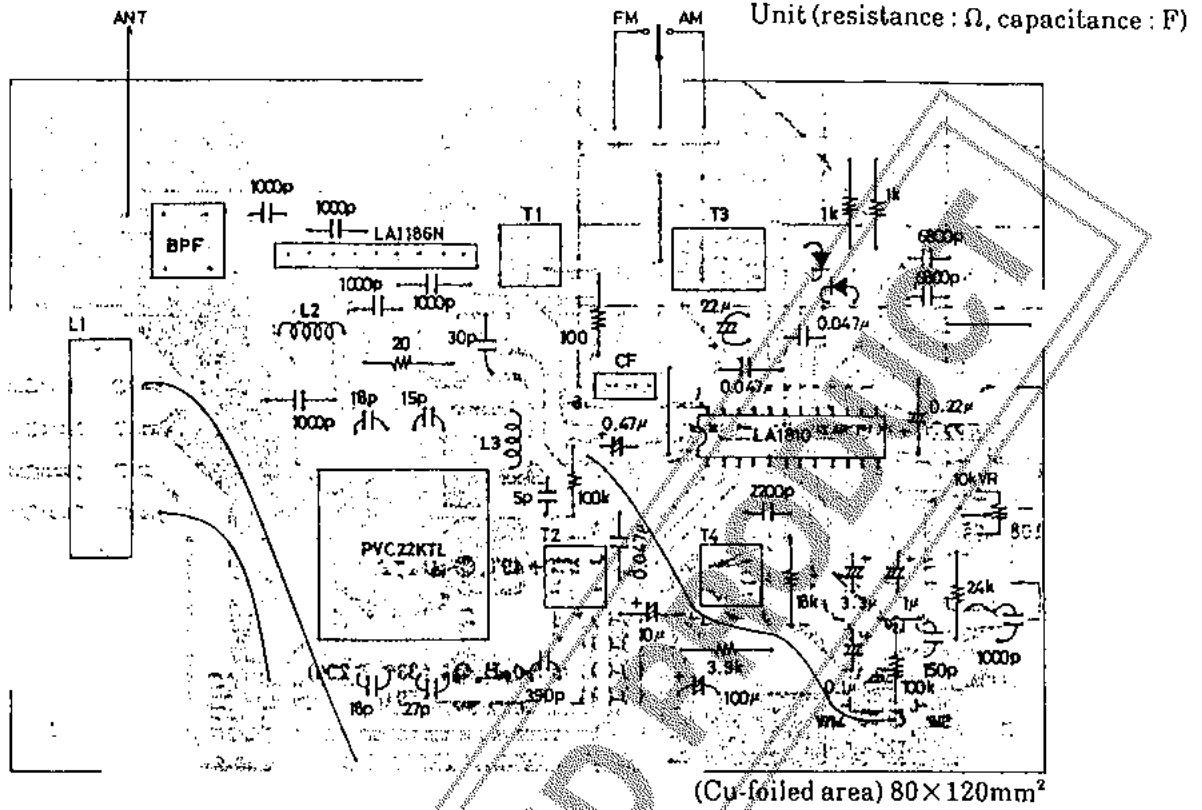

Differences between LA1810 and LA1811

- (1) Same pin assignment.
- (2) The internal circuit of the MPX OUT (pin 9, pin 10) is different as shown below.

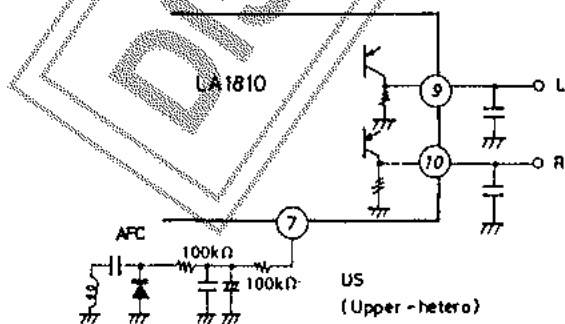

The LA1810 contains the output load resistors.
(Output load resistance = $6.8k\Omega$)

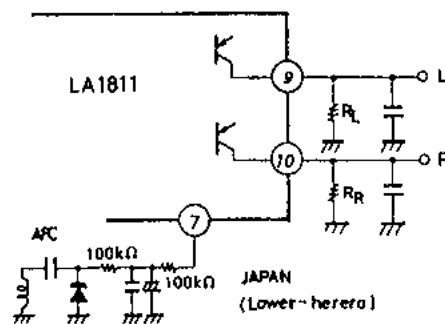

For the LA1811, output load resistors R_L , R_R are connected externally. The graph of demodulation output vs. R_L (R_R) is shown below.

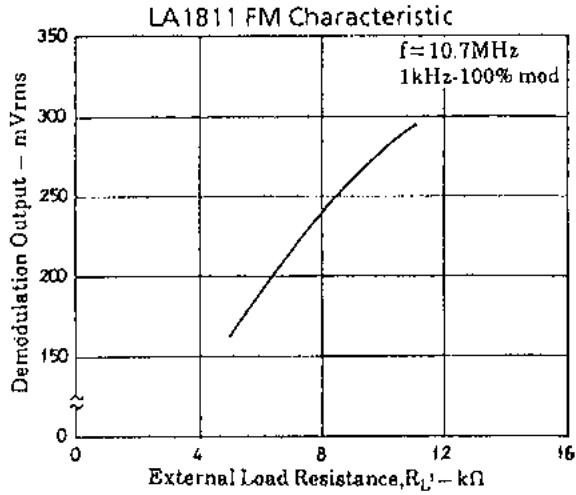

Coil specifications

· MW bar antenna

TN-10896 (Mitsumi)

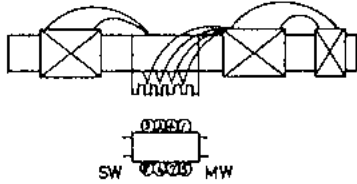

①-② 22T + 49T, ③-④ 10T

⑤-⑥ 17T, 0.5 μ H

⑦-⑧ 4T

①-② $L = 250\mu\text{H}$, $Q_0 \approx 330 (\approx 200)$

⑤-⑥ $L = 15\mu\text{H}$, $Q_0 \approx 250 (\approx 150)$

· AM IFT

HW-6215 (Mitsumi)

HW-6194
SFU-460B

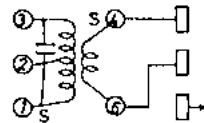

①-② 94T

④-⑥ 7T

②-③ 58T

180pF

· MW OSC

HW-6193 (Mitsumi)

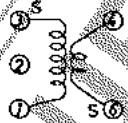

⑥-④ 32T

③-① 64T

$Q_0 = 140$, $L = 140\mu\text{H}$

· FM quadrature

YT-30103 (Mitsumi)

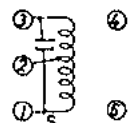

①-③ 10T

$Q_0 = 90$, $f = 10.7\text{MHz}$

82pF

· SW2 OSC

HW-40184 (Mitsumi)

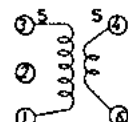

④-⑥ 8T

③-① 12T

$Q_0 \approx 28$, $L = 1.31\mu\text{H}$

Q237-1500 (Sumida)



④-⑥ 8T

③-① 12T

$Q_0 \approx 20$, $L = 1.31\mu\text{H}$

· SW2 ANT

YT-30117 (Mitsumi)

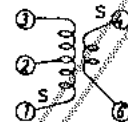

①-② 4T

④-⑥ 2T

②-③ 4T

$Q_0 = 95$, $L = 1.4\mu\text{H}$

2158-4095-319A (Sumida)

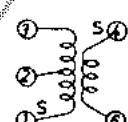

④-⑥ 2T

①-② 5T

②-③ 5T

$Q_0 \approx 40$, $L = 1.4\mu\text{H}$

· LW bar antenna

HH-50161 (Mitsumi)

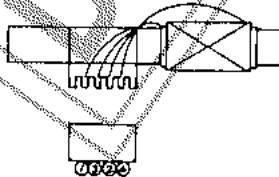

①-② 20T

③-④ 200T

③-④ $L = 2.74\text{mH}$, $Q_0 \approx 200$

· LW OSC

MA-7014 (Mitsumi)

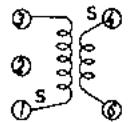

④-⑥ 40T

①-③ 80T

$L = 220\mu\text{H}$, $Q_0 = 130$

DISCONTINUED PRODUCT

- No products described or contained herein are intended for use in surgical implants, life-support systems, aerospace equipment, nuclear power control systems, vehicles, disaster/crime-prevention equipment and the like, the failure of which may directly or indirectly cause injury, death or property loss.
- Anyone purchasing any products described or contained herein for an above-mentioned use shall:
 - ① Accept full responsibility and indemnify and defend SANYO ELECTRIC CO., LTD., its affiliates, subsidiaries and distributors and all their officers and employees, jointly and severally, against any and all claims and litigation and all damages, cost and expenses associated with such use;
 - ② Not impose any responsibility for any fault or negligence which may be cited in any such claim or litigation on SANYO ELECTRIC CO., LTD., its affiliates, subsidiaries and distributors or any of their officers and employees jointly or severally.
- Information (including circuit diagrams and circuit parameters) herein is for example only; it is not guaranteed for volume production. SANYO believes information herein is accurate and reliable, but no guarantees are made or implied regarding its use or any infringements of intellectual property rights or other rights of third parties.

This catalog provides information as of June, 1995. Specifications and information herein are subject to change without notice.