



SANYO Semiconductors

DATA SHEET

LA1837 — Monolithic Linear IC For Home Stereo IC with Electronic Tuning Support Single-Chip IC

Overview

The LA1837 is a single-chip AM/FM IF and MPX IC that supports electronic tuning and was developed for use in home stereo systems. It is optimal for use in automatic station selection systems that use the SD and IF counting techniques.

Features

- On-chip MPX VCO (no external components required).
- Adjacent channel interference rejection function (third and fifth order).
- Supports both the SD and the IF counting techniques.
- The AM and FM SD sensitivities can be set independently.
- The AM and FM output levels can be set independently.
- Improved AM practical sensitivity and high-input distortion characteristics.

Functions

- AM : RF amplifier, mixer, oscillator, IF amplifier, detector AGC, oscillator buffer, S-meter, narrowband SD, IF buffer
- FM-IF : IF amplifier, quadrature detector, S-meter, Scurve detector, IF buffer output
- MPX : PLL stereo decoder, stereo display, forced mono, VCO stop, post amplifier, audio muting, adjacent channel interference rejection function

Specifications

Maximum Ratings at Ta = 25°C

Parameter	Symbol	Conditions	Ratings	Unit
Maximum supply voltage	V _{CC} max		12	V
Allowable power dissipation	Pd max	Ta ≤ 70°C	550	mW
Operating temperature	T _{opr}		-20 to +70	°C
Storage temperature	T _{stg}		-40 to +125	°C

■ Any and all SANYO Semiconductor Co.,Ltd. products described or contained herein are, with regard to "standard application", intended for the use as general electronics equipment (home appliances, AV equipment, communication device, office equipment, industrial equipment etc.). The products mentioned herein shall not be intended for use for any "special application" (medical equipment whose purpose is to sustain life, aerospace instrument, nuclear control device, burning appliances, transportation machine, traffic signal system, safety equipment etc.) that shall require extremely high level of reliability and can directly threaten human lives in case of failure or malfunction of the product or may cause harm to human bodies, nor shall they grant any guarantee thereof. If you should intend to use our products for applications outside the standard applications of our customer who is considering such use and/or outside the scope of our intended standard applications, please consult with us prior to the intended use. If there is no consultation or inquiry before the intended use, our customer shall be solely responsible for the use.

■ Specifications of any and all SANYO Semiconductor Co.,Ltd. products described or contained herein stipulate the performance, characteristics, and functions of the described products in the independent state, and are not guarantees of the performance, characteristics, and functions of the described products as mounted in the customer's products or equipment. To verify symptoms and states that cannot be evaluated in an independent device, the customer should always evaluate and test devices mounted in the customer's products or equipment.

SANYO Semiconductor Co., Ltd.

www.semiconductor-sanyo.com/network

LA1837

Operating Conditions at Ta = 25°C

Parameter	Symbol	Conditions	Ratings	Unit
Recommended supply voltage	V _{CC}		9	V
Operating supply voltage range	V _{CC op}		7 to 11	V

Electrical Characteristics at Ta = 25°C, V_{CC} = 9V, in the specified test circuit

Parameter	Symbol	Conditions	Ratings			Unit
			min	typ	max	
FM Mono characteristics fc = 10.7MHz, fm = 1kHz, with the coil adjusted so that V _{AFC} - V _{REG} = 0V						
Current drain	I _{CCO-FM}	With no input	18	31	44	mA
Demodulation output	V _{OFM}	100dBμ, 100% mod. The pin 16 output	730	1100	1460	mVrms
Channel balance	C.B-mono	100dBμ, 100% mod. The pin 16 output/pin 17 output	-1.5	0	+1.5	dB
Total harmonic distortion (mono)	THD _{FM(1)}	100dBμ, 100% mod. The pin 16 output		0.3	1.3	%
	THD _{FM(2)}	100dBμ, 100% mod. The pin 16 output		1.0	5	%
Signal-to-noise ratio	S/N _{FM}	100dBμ, 100% mod. The pin 16 output	72	80		dB
AM rejection ratio	AMR	100dBμ, 100% mod. The pin 16 output	45	65		dB
Limiting input voltage	-3dBLS.	100dBμ, 100% mod. Referenced to the output. The input such that the output is down -3 dB.	26	32	38	dBμ
LED sensitivity	SD _{On-FM}		51	60	69	dBμ
LED bandwidth	SD _{BW}	100dBμ	85	120	170	kHz
IF count buffer output	V _{IFBuff-FM}	100dBμ, The pin 13 output	80	120	160	mVrms
S-meter output	V _{S_M-FM(1)}	0dBμ, The pin 11 output	0	0.1	0.5	V
	V _{S_M-FM(2)}	100dBμ, The pin 11 output	3.6	4.3	5.0	V
Muting attenuation	Mute-Att	100dBμ, 100% mod. The pin 16 output	75	85		dB
FM stereo characteristics fc = 10.7MHz, 100dBμ, fm = 1kHz, L + R = 90%, pilot = 10%						
Separation (left)	Sep _L	L mod. The pin 16 output/pin 17 output	30	45		dB
Separation (right)	Sep _R	R mod. The pin 17 output/pin 16 output	30	45		dB
Stereo on level	ST _{ON}	The pilot modulation such that V7 is under 0.7V.	1.3	2.7	5	%
Stereo off level	ST _{OFF}	The pilot modulation such that V7 is over 4.5V.		1.5		%
Total harmonic distortion (main)	THD-main	L + R mod. The pin 16 output		0.3	1.3	%
Adjacent channel interference rejection ratio	Brej-3rd	fs = 113kHz, V _S = 90%, Pilot = 10%, The pin 16 output vs. the L-R mod. 1kHz demodulated output		40		dB
	Brej-5th	fs = 189kHz, V _S = 90%, Pilot = 10%, The pin 16 output vs. the L-R mod. 1kHz demodulated output		40		dB
AM characteristics fc = 1000kHz, fm = 1kHz						
Current drain	I _{CCO-AM}	With no input	15	25	35	mA
Detector output	V _{OAM(1)}	23dBμ, 30% mod. The pin 16 output	100	180	360	mVrms
	V _{OAM(2)}	80dBμ, 30% mod. The pin 16 output	200	320	500	mVrms
Signal-to-noise ratio	S/N _{AM(1)}	23dBμ, 30% mod. The pin 16 output	18	22		dB
	S/N _{AM(2)}	80dBμ, 30% mod. The pin 16 output	49	55		dB
Total harmonic distortion (mono)	THD _{AM(1)}	80dBμ, 30% mod. The pin 16 output		0.4	1.2	%
	THD _{AM(2)}	80dBμ, 80% mod. The pin 16 output		1.0	4.0	%
LED sensitivity	SD _{On-AM}		17	27	37	dBμ
Local oscillator buffer output	V _{OSC-AM}	With no input. The pin 30 output	110	160	220	mVrms
IF counter buffer output	V _{IFBuff-AM}	80dBμ, no modulation. The pin 13 output	160	220	300	mVrms
ST-IF output	V _{STIF-AM}	80dBμ, no modulation. The pin 7 output	16	34	48	mVrms
S-meter output	V _{S_M-AM}	0dBμ, no modulation.	0	0	0.2	V

LA1837

Package Dimensions

unit : mm (typ)

3196A

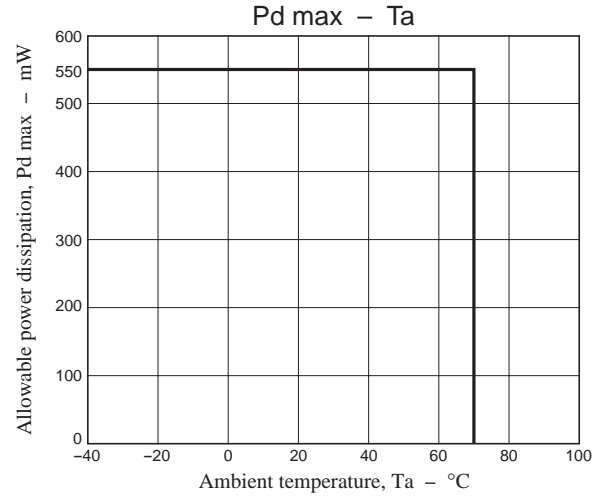
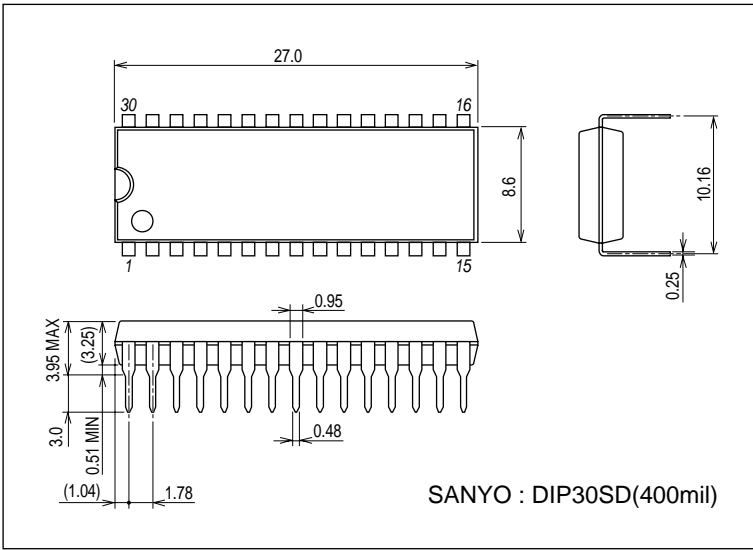

Block Diagram

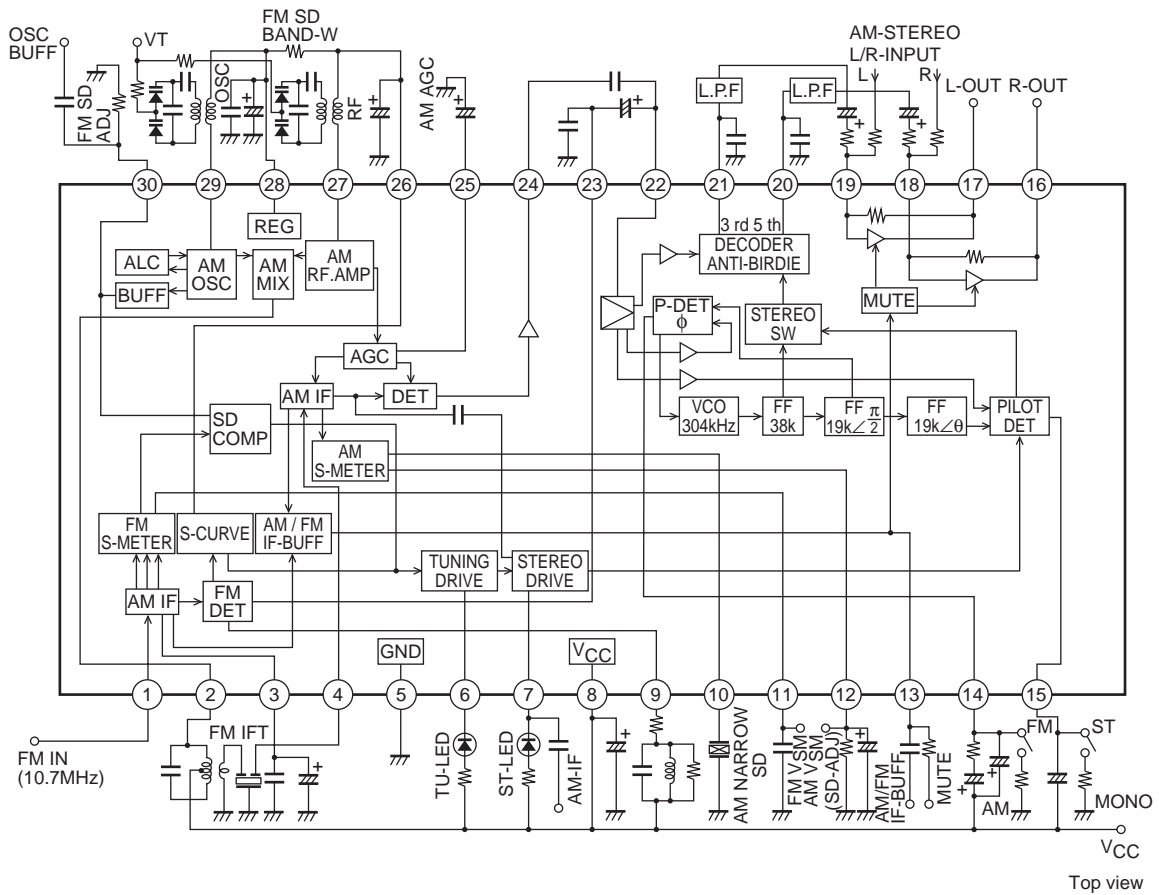

LA1837

Test Circuit

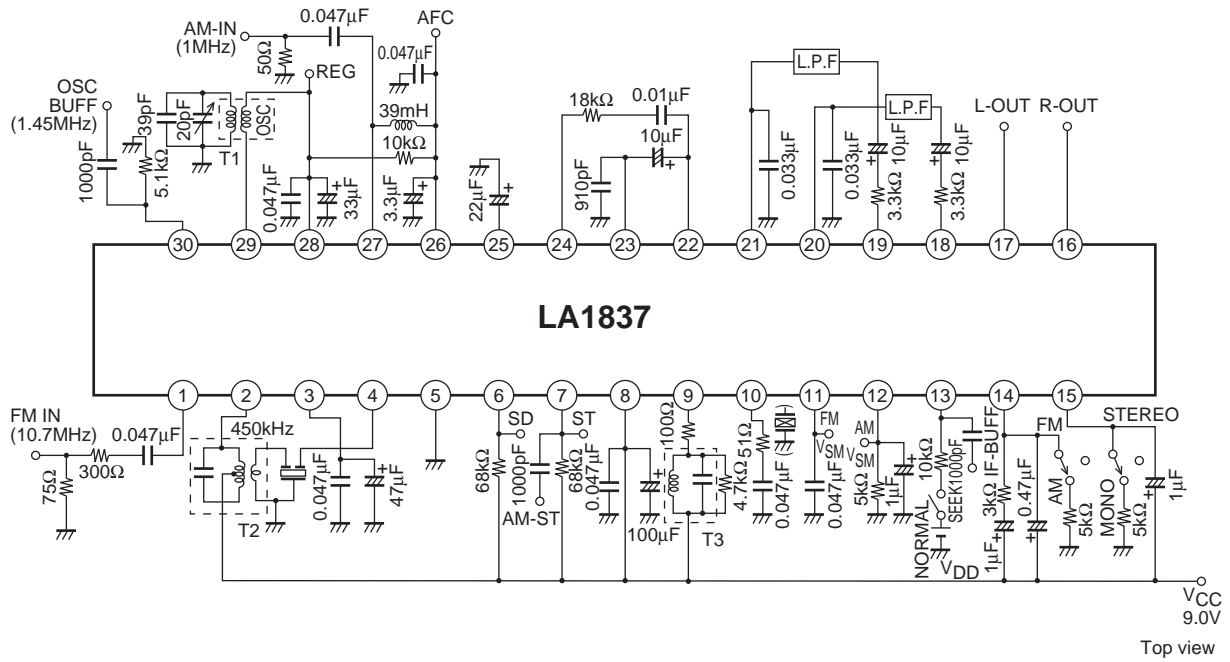

Pin Functions

Pin No.	Pin function	Pin voltage (V)	Pin description	Equivalent circuit
1	FM IF input	V _{reg}	Input impedance $r_1 = 330\Omega$	
2	AM mixer output	V _{CC}	Connect the mixer coil between this pin and V _{CC} .	
3	FM IF input bypass	V _{reg}	Also functions as the MPX regulator filter.	See pin 1.
4	AM IF input	V _{reg}	Input impedance $r_1 = 2k\Omega$	
5	GND	0V		
6	TU-LED	V _{CC}	Active low	
7	ST-LED	V _{CC}	Open collector output	
	AM-IF output		AM stereo IF output (pin 7) The current input must not exceed 150μA.	
8	V _{CC}	V _{CC}		
9	FM detector	V _{CC}	Recommended detector coil : 600BEAS-9715Z (The Toko Electric Corporation)	
10	AM narrow band CF connection	1.3V	Recommended narrow band CF: BFU450 C4N (Murata Mfg. Co., Ltd.) If the narrow band SD is not used, bypass this circuit with a 50Ω resistor and a 0.047μF capacitor connected in series.	

Continued on next page.

LA1837

Continued from preceding page.

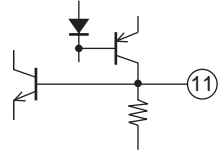
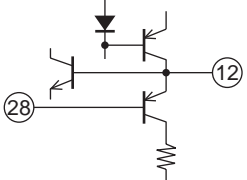
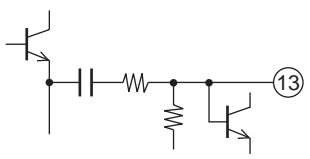
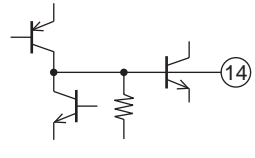
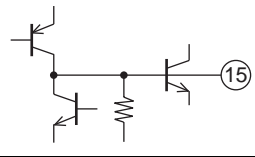
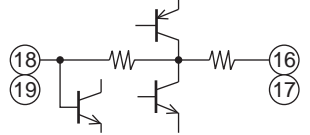
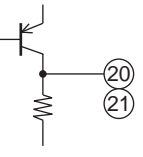
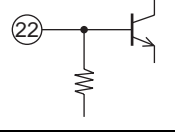
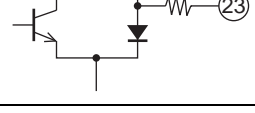
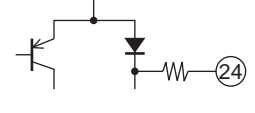
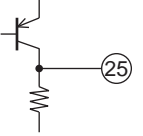
Pin No.	Pin function	Pin voltage (V)	Pin description	Equivalent circuit
11	FM-S-meter output	0V	$R_L = 8k\Omega$	
12	AM S-meter output AM SD sensitivity adjustment	0V (AM)	The AM SD sensitivity is adjusted with the value of the external resistor connected between this pin and ground.	
13	AM and FM IF buffer output, output control switch (mute switch)	0V	$V_{13} \leq 0.5V$: Reception state $1.4V \leq V_{13} \leq 2.2V$: IF buffer output turned on $V_{13} \geq 3.5V$: IF buffer output and muting are turned on	
14	Phase comparator low-pass filter (FM/AM switching)	$V_{CC}-1.4$ (FM) 0V (AM)	Connecting this pin to ground through a resistor sets the IC to AM mode. Resistor value limits : 2.7k Ω (when $V_{CC} = 7V$) 3.9k Ω (8V) 5.1k Ω (9V) 6.2k Ω (10V) 7.5k Ω (11V)	
15	Pilot detector low-pass filter (forced mono) (VCO stop)	$V_{CC}-1.0$	If a current of 50 μ A or greater flows from this pin, the system is forced to mono. Connecting this pin to ground stops the VCO. The resistor limit values are the same as for pin 14.	
16 17 18 19	Post amplifier input and output	Vreg Vreg	Output impedance $r_O = 200\Omega$ Pin 16 : right output, pin 17 : left output Inverting inputs Pin 18 : right input, pin 19 : left input $R_{NF} = 33k\Omega$	
20 21	MOX output	3.5V 3.5V	Output impedance $r_O = 3.3k\Omega$ Pin 20 : right de-emphasis Pin 21 : left de-emphasis	
22	MPX input	2.9V	Input impedance $r_i = 20k\Omega$	
23	FM demodulator output	2.8V (FM) 2.8V (AM)	Output impedance $r_O = 3.0k\Omega$ The separation can be modified by inserting a capacitor between this pin and ground. Set $V_{O \text{ sub}}/V_{O \text{ main}}$ to be about 0 dB.	
24	AM detector output	0V (FM) 0.5V (AM)	Output impedance $r_O = 3.3k\Omega$ The AM frequency characteristics can be modified by adjusting the time constants of the circuits between this pin and pin 22, and between this pin and ground.	
25	AM AGC	0V (FM) 0.5V (AM)	The built-in load resistor $R = 11k\Omega$.	

Continued on next page.

LA1837

Continued from preceding page.

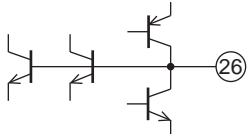
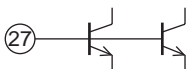
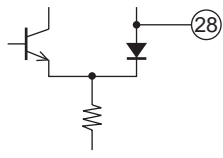
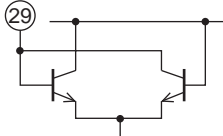
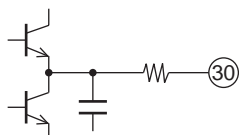
Pin No.	Pin function	Pin voltage (V)	Pin description	Equivalent circuit
26	AFC	Vreg	The FM SD bandwidth can be modified with the external resistor connected between this pin and pin 28.	
27	AM RF input	Vreg	Use this pin at the same potential as pin 28.	
28	REG	Vreg	Vreg = 3.6V	
29	OSC	Vreg	Use an oscillator coil between this pin and pin 28.	
30	Oscillator buffer output, FM SD sensitivity adjustment	1.6V (FM) 1.3V (AM)	The FM SD sensitivity can be modified with the external resistor connected between this pin and ground. Output impedance $r_o = 20\Omega$	

Coil specifications (bottom view)

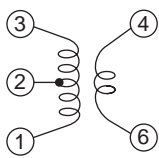
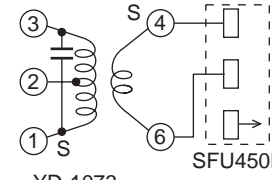
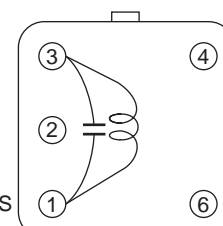
<p>•AM oscillator (for the DUT) HW-50425 (Mitsumi Electric Co., Ltd.)</p>  <p>3-2 2T 4-6 9T 2-1 86T Qo ≥ 80 L = 270μH</p>	<p>•IFT YD-1073-1 (Mitsumi Electric Co., Ltd.)</p>  <p>1-2 58T 4-6 7T 2-3 94T fo = 450kHz Qo = 110 Includes an internal 180pF capacitor. SFU450B included.</p>
<p>•FM detector 600BEAS-9715Z (The Toko Electric Corporation)</p>  <p>3-1 22T f = 10.7MHz Qo = 40 Includes an internal 82pF capacitor.</p>	

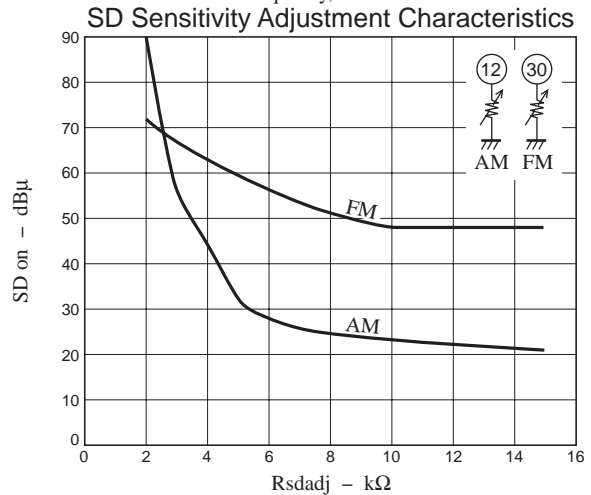
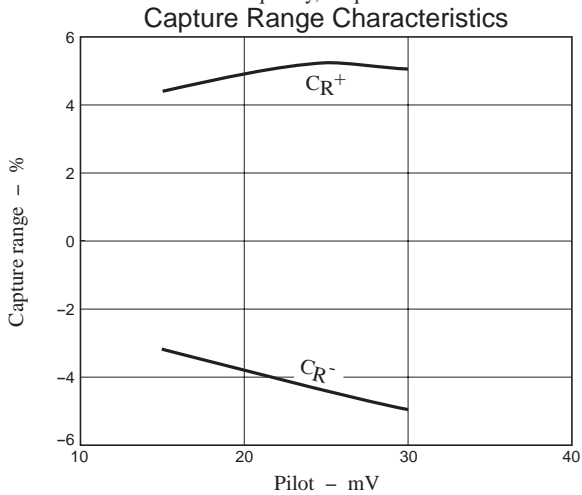
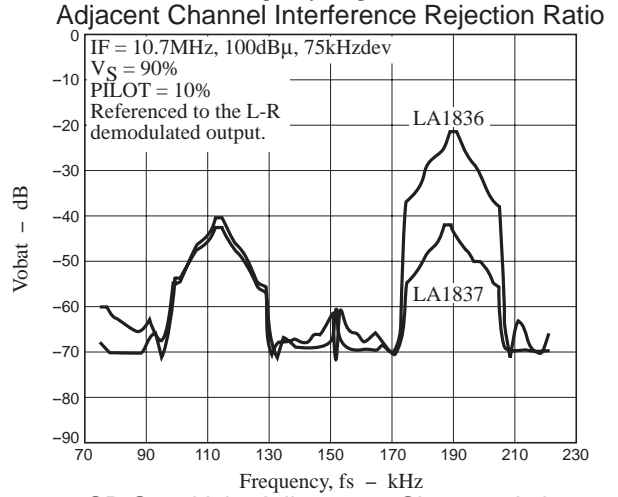
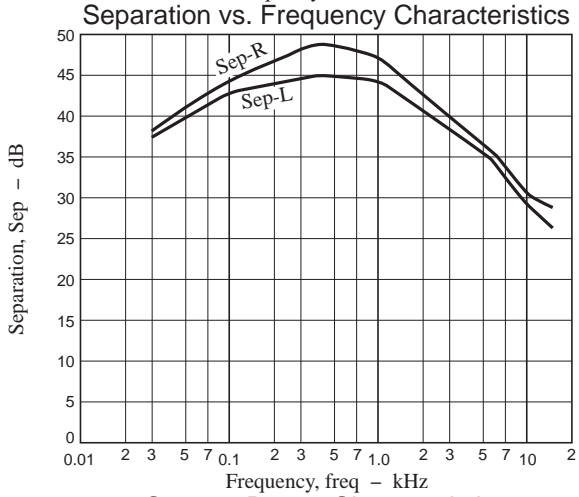
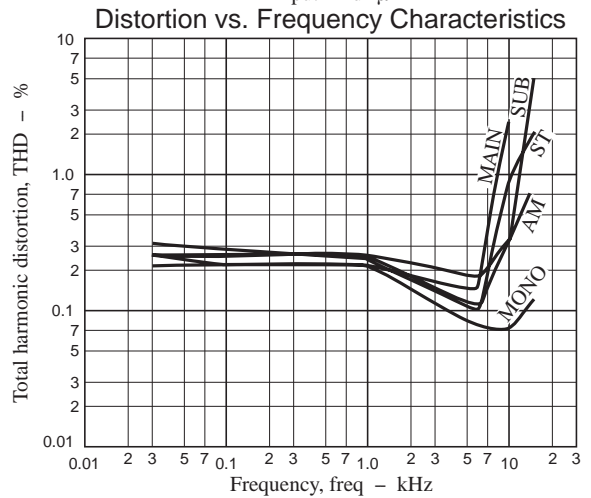
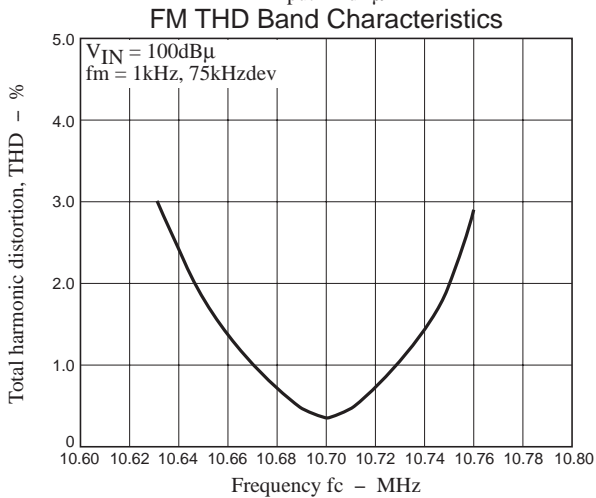
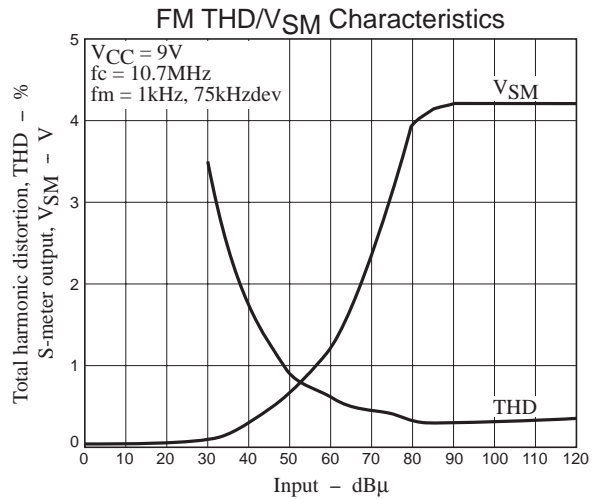
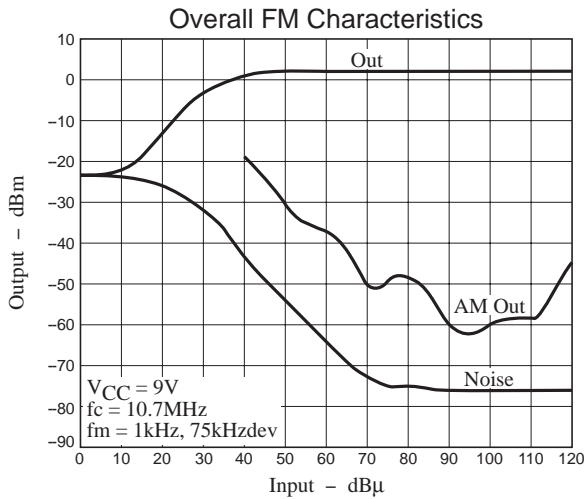

SD Sensitivity Adjustment Characteristics

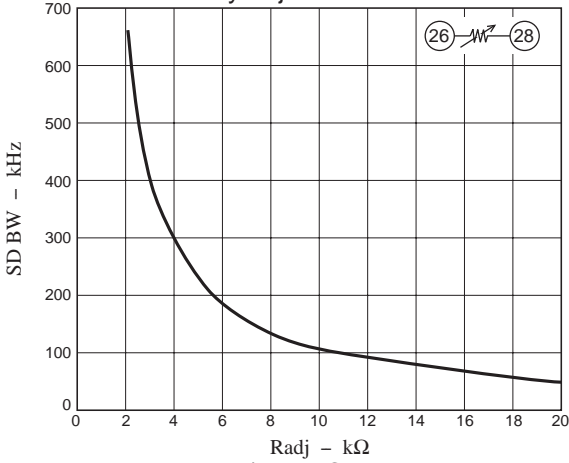

Overall AM Characteristics

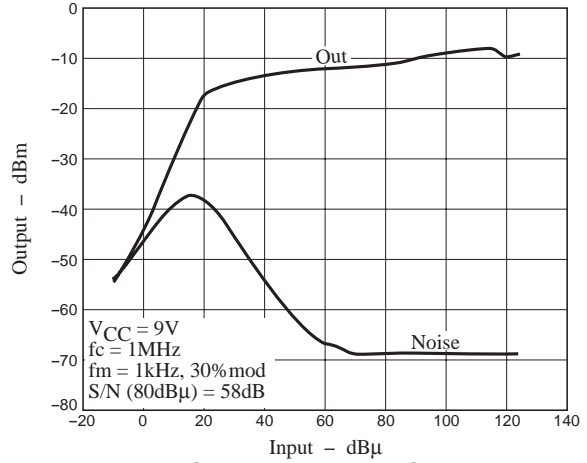

AM THD / VSM Characteristics

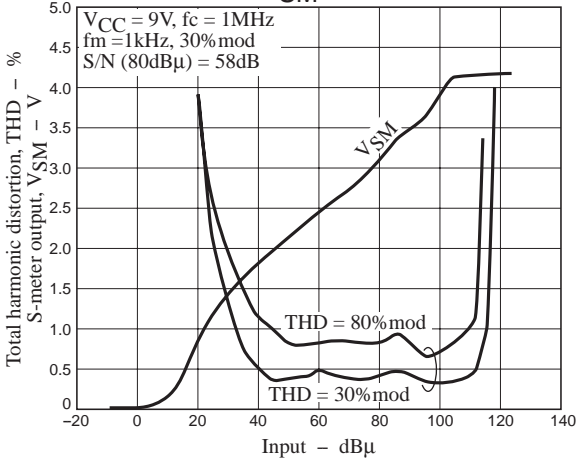

AM Detector Output Frequency Characteristics (1)

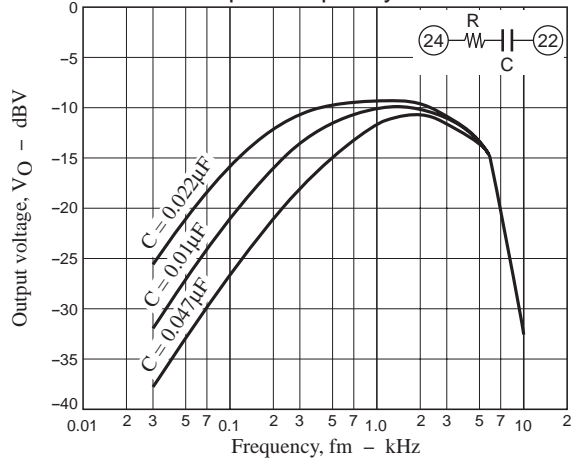

AM Detector Output Frequency Characteristics (2)

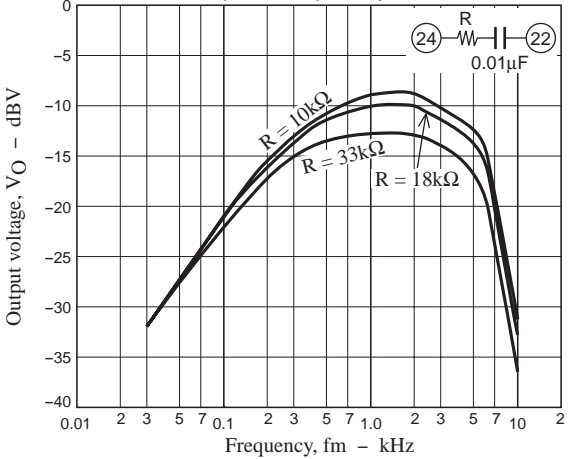

Distortion vs. Ambient Temperature Characteristics

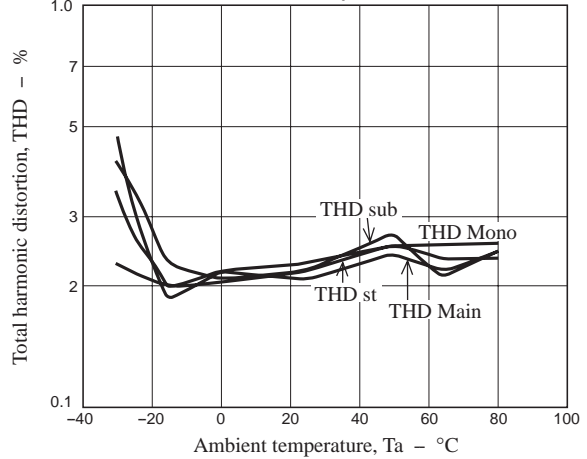

Separation vs. Ambient Temperature Characteristics

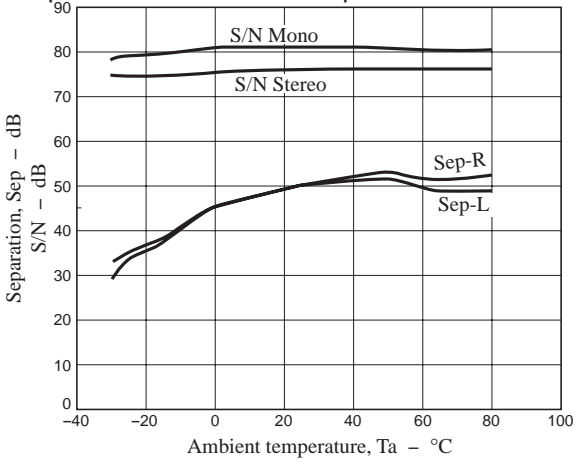

- SANYO Semiconductor Co.,Ltd. assumes no responsibility for equipment failures that result from using products at values that exceed, even momentarily, rated values (such as maximum ratings, operating condition ranges, or other parameters) listed in products specifications of any and all SANYO Semiconductor Co.,Ltd. products described or contained herein.
- SANYO Semiconductor Co.,Ltd. strives to supply high-quality high-reliability products, however, any and all semiconductor products fail or malfunction with some probability. It is possible that these probabilistic failures or malfunction could give rise to accidents or events that could endanger human lives, trouble that could give rise to smoke or fire, or accidents that could cause damage to other property. When designing equipment, adopt safety measures so that these kinds of accidents or events cannot occur. Such measures include but are not limited to protective circuits and error prevention circuits for safe design, redundant design, and structural design.
- In the event that any or all SANYO Semiconductor Co.,Ltd. products described or contained herein are controlled under any of applicable local export control laws and regulations, such products may require the export license from the authorities concerned in accordance with the above law.
- No part of this publication may be reproduced or transmitted in any form or by any means, electronic or mechanical, including photocopying and recording, or any information storage or retrieval system, or otherwise, without the prior written consent of SANYO Semiconductor Co.,Ltd.
- Any and all information described or contained herein are subject to change without notice due to product/technology improvement, etc. When designing equipment, refer to the "Delivery Specification" for the SANYO Semiconductor Co.,Ltd. product that you intend to use.
- Information (including circuit diagrams and circuit parameters) herein is for example only; it is not guaranteed for volume production.
- Upon using the technical information or products described herein, neither warranty nor license shall be granted with regard to intellectual property rights or any other rights of SANYO Semiconductor Co.,Ltd. or any third party. SANYO Semiconductor Co.,Ltd. shall not be liable for any claim or suits with regard to a third party's intellectual property rights which has resulted from the use of the technical information and products mentioned above.

This catalog provides information as of July, 2009. Specifications and information herein are subject to change without notice.