



Contact SAMSUNG WORLDWIDE

If you have any questions or comments relating to Samsung products, please contact the SAMSUNG customer care centre.

Country	Customer Care Centre ☎	Web Site
AUSTRALIA	1300 362 603	www.samsung.com
CHINA	800-810-5858 010-6475 1880	www.samsung.com
HONG KONG	3698-4698	www.samsung.com/hk
INDIA	3030 8282 1800 110011	www.samsung.com
INDONESIA	0800-112-8888	www.samsung.com
JAPAN	0120-327-527	www.samsung.com/jp
MALAYSIA	1800-88-9999	www.samsung.com/my
NEW ZEALAND	0800SAMSUNG(726-7864)	www.samsung.com/nz
PHILIPPINES	1800-10-SAMSUNG(726-7864)	www.samsung.com/ph
SINGAPORE	1800-SAMSUNG(726-7864)	www.samsung.com
THAILAND	1800-29-3232 02-689-3232	www.samsung.com
TAIWAN	0800-329-999	www.samsung.com/tw
VIETNAM	1 800 588 889	www.samsung.com
SOUTH AFRICA	0860-SAMSUNG(726-7864)	www.samsung.com
U.A.E	800-SAMSUNG (726-7864) 8000-4726	www.samsung.com



BN68-01507A-01

SERIES
4

LCD TV

user manual

imagine the possibilities

Thank you for purchasing this Samsung product.
To receive more complete service, please register
your product at

www.samsung.com/global/register

Model _____ Serial No. _____



Precautions When Displaying a Still Image

A still image may cause permanent damage to the TV screen.

- Do not display a still image on the LCD panel for more than 2 hours as it can cause screen image retention. This image retention is also known as "screen burn". To avoid such image retention, reduce the degree of brightness and contrast of the screen when displaying a still image.
-  Watching the LCD TV in 4:3 format for a long period of time may leave traces of borders displayed on the left, right and center of the screen caused by the difference of light emission on the screen. Playing a DVD or a game console may cause a similar effect to the screen. Damages caused by the above effect are not covered by the Warranty.
- Displaying still images from Video games and PC for longer than a certain period of time may produce partial after-images.
To prevent this effect, reduce the 'brightness' and 'contrast' when displaying still images.

Contents

CONNECTING AND PREPARING YOUR TV

- ◆ List of Parts 2
- ◆ Installing the Stand..... 2
- ◆ Installing the Wall Mount Kit..... 2
- ◆ Viewing the Control Panel..... 3
- ◆ Viewing the Connection Panel..... 4
- ◆ Viewing the Remote Control..... 6
- ◆ Installing Batteries in the Remote Control..... 7
- ◆ Switching On and Off 7
- ◆ Placing Your Television in Standby Mode..... 7
- ◆ Viewing the Menus 8
- ◆ Using the TOOLS Button..... 8
- ◆ Plug & Play..... 9

SETTING THE CHANNELS

- ◆ Storing Channels Automatically 10
- ◆ Storing Channels Manually 11
- ◆ Adding / Locking Channels 12
- ◆ Sorting the Stored Channels 13
- ◆ Assigning Channels Names 13
- ◆ Fine Tuning Channel Reception 14

SETTING THE PICTURE

- ◆ Changing the Picture Standard 15
- ◆ Adjusting the Custom Picture 16
- ◆ Configuring Detailed Settings on the Picture ... 16
- ◆ Resetting the Picture Settings to the
Factory Defaults 17
- ◆ Changing the Picture Options 18
- ◆ Viewing the Picture In Picture (PIP) 20

SETTING THE SOUND

- ◆ Sound Features 21
- ◆ Selecting the Sound Mode 22
- ◆ Connecting Headphones (Sold separately) 22

SETTING THE TIME

- ◆ Setting and Displaying the Current Time..... 23
- ◆ Setting the Sleep Timer 23
- ◆ Switching the Television On and Off
Automatically 24

FUNCTION DESCRIPTION

- ◆ Choosing Your Language 24
- ◆ Melody / Entertainment / Energy Saving 25
- ◆ Selecting the Source 26
- ◆ Editing the Input Source Names 26

SETTING THE PC

- ◆ Setting up Your PC Software
(Based on Windows XP) 27
- ◆ Display Modes 27
- ◆ Setting up the TV with your PC 28

RECOMMENDATIONS FOR USE

- ◆ Teletext Feature 29
- ◆ Using the Anti-Theft Kensington Lock
(depending on the model) 31
- ◆ Troubleshooting: Before Contacting
Service Personnel 32
- ◆ Technical and Environmental Specifications ... 33

Symbol

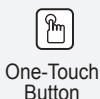

List of Parts

Please make sure the following items are included with your LCD TV.
If any items are missing, contact your dealer.

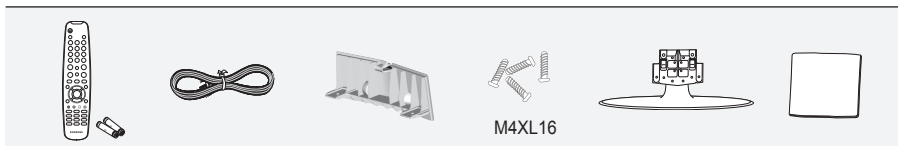

Remote Control &
Batteries
(AAA x 2)

Power Cord

Cover-Bottom

Stand Screw X 4
M4XL16

Stand

Cleaning Cloth

♦ Owner's Instructions

♦ Warranty card

♦ Safety Guide

♦ Registration Cards

- Warranty card / Safety Guide / Registration Cards (Not available in all locations)
- The stand and stand screw may not be included depending on the model.

Installing the Stand

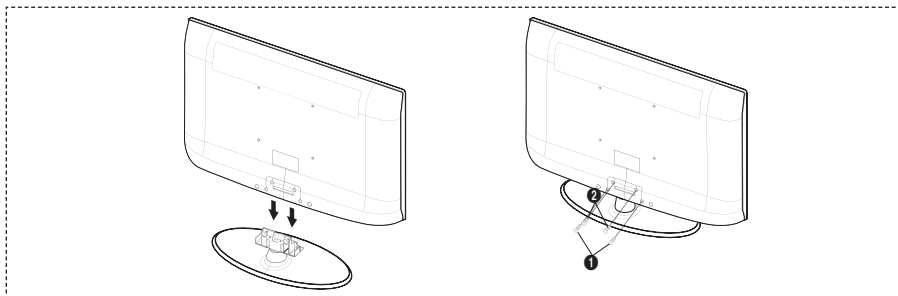

1. Connect your LCD TV and the stand.
 - Two or more people should carry the TV.
 - Make sure to distinguish between the front and back of the stand when assembling them.
2. Fasten two screws at position ❶ and then fasten two screw at position ❷.
 - Stand the product up and fasten the screws. If you fasten the screws with the LCD TV placed down, it may lean to one side.
 - The stand is installed for models with the screen size of 37 inch and above.

Installing the Wall Mount Kit

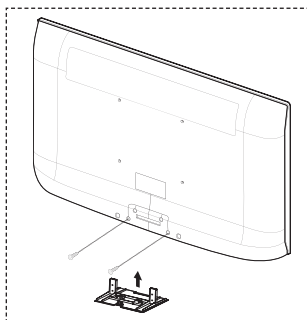

Wall mount items (sold separately) allow you to mount the TV on the wall.

For detailed information on installing the wall mount, see the instructions provided with the Wall Mount items. Contact a technician for assistance when installing the wall mounted bracket. Samsung Electronics is not responsible for any damage to the product or injury to yourself or others if you elect to install the TV on your own.





Do not install your Wall Mount Kit while your TV is turned on. It may result in personal injury due to electric shock.

- Remove the stand and cover the bottom hole with a cap and fasten with two screws.

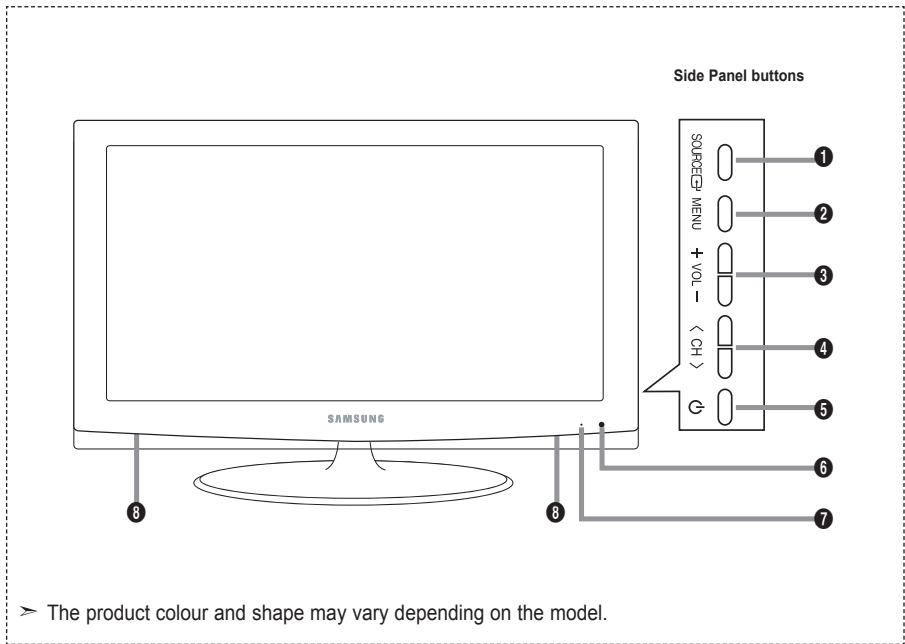
Viewing the Control Panel



➤ The product colour and shape may vary depending on the model.

- 1 SOURCE**  Toggles between all the available input sources (TV, AV, S-Video, Component1, Component2, PC, HDMI). In the on-screen menu, use this button as you use the **ENTER**  button on the remote control.
- 2 MENU** Press to see an on-screen menu of your TV's features.
- 3 + VOL -** Press to decrease or increase the volume. In the on-screen menu, use the **+ VOL -** buttons as you use the **◀** and **▶** buttons on the remote control.
- 4 < CH >** Press to change channels. In the on-screen menu, use the **< CH >** buttons as you use the **▲** and **▼** buttons on the remote control. (Without the Remote Control, you can turn on the TV by using the Channel buttons.)
- 5  (Power)** Press to turn the TV on and off.
- 6 Remote Control Sensor** Aim the remote control towards this spot on the TV.
- 7 Power Indicator** Blinks and turns off when the power is on and lights up in stand-by mode.
- 8 Speakers**

Viewing the Connection Panel

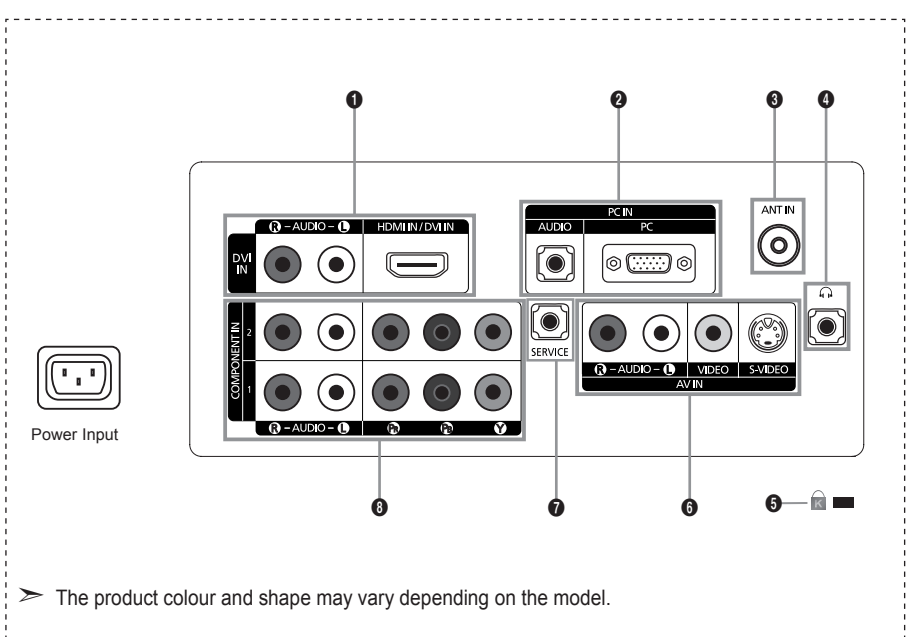

- Whenever you connect an external device to your TV, make sure that power on the unit is turned off.
- When connecting an external device, match the colour of the connection terminal to the cable.

1 HDMI / DVI IN [R-AUDIO-L]

- Supports connections between HDMI-connection-enabled AV devices (Set-Top Boxes, DVD players)
- No additional Audio connection is needed for an HDMI to HDMI connection.
- When using an HDMI/DVI cable connection, you must use the HDMI IN / DVI IN jack.

➤ What is HDMI?

- "High Definition Multimedia interface" allows the transmission of high definition digital video data and multiple channels of digital audio.
- The HDMI/DVI terminal supports DVI connection to an extended device with the appropriate cable (not supplied). The difference between HDMI and DVI is that the HDMI device is smaller in size, has the HDCP (High Bandwidth Digital Copy Protection) coding feature installed, and supports multi - channel digital audio.

2 PC IN [PC] / [AUDIO]

- Connect to the video and audio output jack on your PC.

3 ANT IN

To view television channels correctly, a signal must be received by the set from one of the following sources:

- An outdoor aerial / A cable television network / A satellite network

4 Headphones jack

- Headphone may be connected to the headphone output on your set. While the head phone is connected, the sound from the built-in speakers will be disabled.

5 Kensington Lock (depending on the model)

- The Kensington Lock (optional) is a device used to physically fix the system when used in a public place.
- If you want to use a locking device, contact the dealer where you purchased the TV.
- The location of the kensington Lock may be different depending on its model.

6 Connecting External A/V Devices

- Connect RCA cable to an appropriate external A/V device such as VCR, DVD or Camcorder.
- Connect RCA audio cables to [R-AUDIO-L] on the rear of your set and the other ends to corresponding audio out connectors on the A/V device.

7 SERVICE

- Connector for SERVICE only.

8 COMPONENT IN

- Connect component video cables (optional) to component connector ("P_R", "P_B", "Y") on the rear of your set and the other ends to corresponding component video out connectors on the DVD.
- If you wish to connect both the Set-Top Box and DVD, you should connect the Set-Top Box to the DVD and connect the DVD to component connector ("P_R", "P_B", "Y") on your set.
- The P_R, P_B and Y connectors on your component devices (DVD) are sometimes labeled Y, B-Y and R-Y or Y, Cb and Cr.
- Connect RCA audio cables (optional) to [R-AUDIO-L] on the rear of your set and the other ends to corresponding audio out connectors on the DVD.

Viewing the Remote Control

- 1 Television Standby button
- 2 Selects the TV mode directly
- 3 Number buttons for direct channel access
- 4 One/Two-digit channel selection
- 5 ⊕: Volume increase
⊖: Volume decrease
- 6 Temporary sound switch-off
- 7 Use to quickly select frequently used functions.
- 8 Use to see information on the current broadcast
- 9 Colour buttons :
Use these buttons in the Channel list, etc.
- 11 Displays the Channel List on screen
- 12 Available source selection
- 13 Previous channel
- 14 P⊙: Next channel
P⊙: Previous channel
- 15 Returns to the previous menu
- 16 Control the cursor in the menu
- 17 Exit the on-screen menu
- 18 Picture size selection
- 19 Displays the main on-screen menu
- 20 Selects the HDMI mode directly.
- 21 Picture effect selection

Teletext Functions

- 2 Exit from the teletext display
- 7 Teletext size selection
- 8 Teletext reveal
- 9 Fastext topic selection
- 10 Alternately select Teletext, Double, or Mix.
- 11 Teletext store
- 12 Teletext mode selection (LIST/FLOF)
- 13 Teletext sub page
- 14 P⊙: Teletext next page
P⊙: Teletext previous page
- 15 Teletext hold
- 17 Teletext cancel
- 19 Teletext index

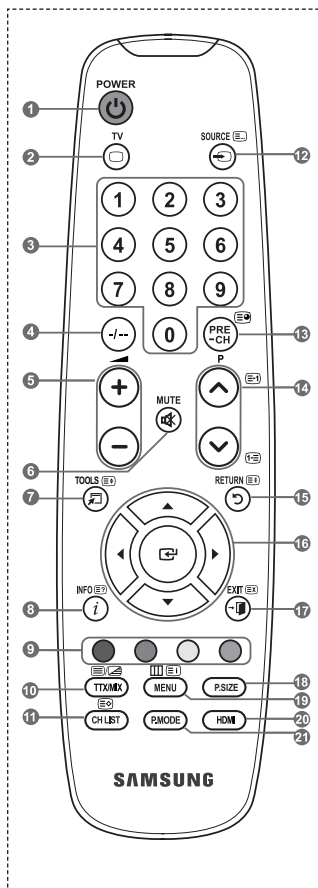

- The performance of the remote control may be affected by bright light.

Installing Batteries in the Remote Control

1. Lift the cover at the back of the remote control upward as shown in the figure.
2. Install two AAA size batteries.
 - Make sure to match the "+" and "-" ends of the batteries with the diagram inside the compartment.
3. Replace the cover.
 - Remove the batteries and store them in a cool, dry place if you won't be using the remote control for a long time.

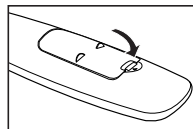
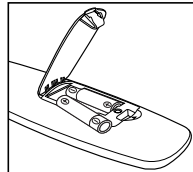
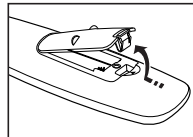

-
- If the remote control doesn't work, check the following:
 1. Is the TV power on?
 2. Are the plus and minus ends of the batteries reversed?
 3. Are the batteries drained?
 4. Is there a power outage, or is the power cord unplugged?
 5. Is there a special fluorescent light or neon sign nearby?
-

Switching On and Off

The mains lead is attached to the rear of your set.

1. Plug the mains lead into an appropriate socket.
 - The standby indicator lights up on your set.
2. Press the **⏻** button on your set.
 - You also can press the **POWER** **⏻** button or the **TV** button on the remote control to turn the TV on.
 - The channel that you were watching last is reselected automatically
3. Press the numeric button (0~9) or channel up/down (**⏮**/**⏭**) button on the remote control or **< CH >** button on your set.
 - When you switch the set on for the very first time, you will be asked to choose language in which the menus are to be displayed.
4. To switch your set off, press the **POWER** **⏻** button again.

Placing Your Television in Standby Mode

Your set can be placed in standby mode in order to reduce the power consumption. The standby mode can be useful when you wish to interrupt viewing temporarily (during a meal, for example).

1. Press the **POWER** **⏻** button on the remote control.
 - The screen is turned off and a red standby indicator appears on your set.
2. To switch your set back on, simply press the **POWER** **⏻**, numeric buttons (**0-9**), **TV** button or channel up/down (**⏮**/**⏭**) button again.
 - Do not leave your set in standby mode for long periods of time (when you are away on holiday, for example).
It is best to unplug the set from the mains and aerial.

Viewing the Menus

1. With the power on, press the **MENU** button.
The main menu appears on the screen. The menu's left side has icons: Picture, Sound, Channel, Setup, Input.
2. Press the **▲** or **▼** button to select one of the icons.
Then press the **ENTER** button to access the icon's sub-menu.
3. Press the **EXIT** button to exit.
➤ The on-screen menus disappear from the screen after about one minute.

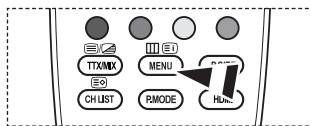
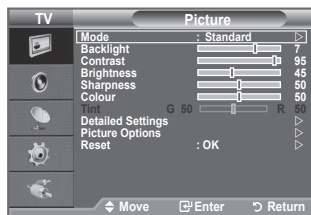

Using the TOOLS Button

You can use the **TOOLS** button to select your frequently used functions quickly and easily. The "Tools" menu change depending on which external input mode you are viewing.

1. Press the **TOOLS** button.
The "Tools" menu will appear.
2. Press the **▲** or **▼** button to select a menu.
3. Press the **▲/▼/◀/▶/ENTER** buttons to display, change, or use the selected items. For a more detailed description of each function, refer to the corresponding page.

- Picture Mode, see page 15
- Sound Mode, see page 21
- Sleep Timer, see page 23
- SRS TS XT, see page 21
- Energy Saving, see page 25
- Dual I-I, see page 22
- PIP, see page 20
- Auto Adjustment, see page 28

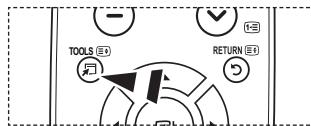
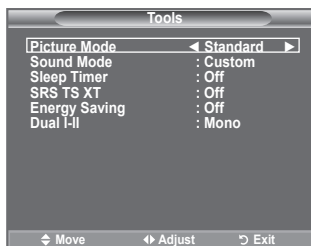

Plug & Play

When the TV is initially powered on, several basic settings proceed automatically and subsequently. The following settings are available.

1. Press the **POWER** button on the remote control. The message "Start Plug & Play." is displayed with "OK" selected.
2. Select the appropriate language by pressing the **▲** or **▼** button. Press the **ENTER** button to confirm your choice.
3. Press the **◀** or **▶** button to select "Store Demo" or "Home Use", then the **ENTER** button.
 - > We recommend setting the TV to "Home Use" mode for the best picture in your home environment.
 - > "Store Demo" mode is only intended for use in retail environments.
 - > If the unit is accidentally set to "Store Demo" mode and you want to return to "Home Use" (Standard): Press the Volume button on the TV. When the volume OSD is displayed, press and hold the **MENU** button on the TV for 5 seconds
4. The message "Check antenna input." is displayed with "OK" selected. Press the **ENTER** button.
 - > Please check that the antenna cable is connected correctly.
5. Select the appropriate area by pressing the **▲** or **▼** button. Press the **ENTER** button to confirm your choice.
6. The "Auto Store" menu is displayed with the "Start" selected. Press the **ENTER** button.
 - > The channel search will start and end automatically.
 - > After all the available channels are stored, the "Clock Set" menu appears.
 - > Press the **ENTER** button at any time to interrupt the memorization process.
7. Press the **ENTER** button. Select the "Month", "Day", "Year", "Hour", "Minute" or "am/pm" by pressing the **◀** or **▶** button. Set the "Month", "Day", "Year", "Hour", "Minute" or "am/pm" by pressing the **▲** or **▼** button.
 - > You can also set the "Month", "Day", "Year", "Hour" and "Minute" by pressing the number buttons on the remote control.
8. Press the **ENTER** button to confirm your setting. The message "Enjoy your viewing" is displayed. When you have finished, press the **ENTER** button.
 - > Even if the **ENTER** button is not pressed, the message will automatically disappear after several seconds.

- ♦ **Language:** Select your language.
- ♦ **Area:** Select your area.
- ♦ **Auto Store:** Automatically scans for and stores channels available in the local area.
- ♦ **Clock Set:** Sets the current time for the TV clock.



If you want to reset this feature...

1. Press the **MENU** button to display the menu. Press the **▲** or **▼** button to select "Setup" then press the **ENTER** button.
2. Press the **ENTER** button again, to select "Plug & Play". For further details on setting up options, refer to the page 9.
 - > The "Plug & Play" feature is only available in the TV mode.

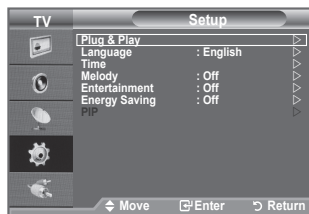

Storing Channels Automatically

You can scan for the frequency ranges available to you (and availability depends on your area).

Automatically allocated programme numbers may not correspond to actual or desired programme numbers. However, you can sort numbers manually and clear any channels you do not wish to watch.

1. Press the **MENU** button to display the menu.
Press the **▲** or **▼** button to select "Channel", then press the **ENTER** button.
2. Press the **ENTER** button to select "Area".
3. Select the appropriate area by pressing the **▲** or **▼** button.
Press the **ENTER** button to confirm your choice.
4. Press the **▲** or **▼** button to select "Auto Store", then press the **ENTER** button.
5. Press the **ENTER** button.
 - The TV will begin memorizing all of the available channels.
 - Press the **ENTER** button at any time to interrupt the memorization process and return to the "Channel" menu.
6. After all the available channels are stored, the "Sort" menu appears. (refer to page 13)



Storing Channels Manually

You can store television channels, including those received via cable networks.

When storing channels manually, you can choose:

- ◆ Whether or not to store each of the channels found.
- ◆ The programme number of each stored channel which you wish to identify.

1. Press the **MENU** button to display the menu. Press the **▲** or **▼** button to select "Channel", then press the **ENTER** button.
2. Press the **▲** or **▼** button to select "Manual Store", then press the **ENTER** button.
3. Select the required option by pressing the **▲** or **▼** button, then press the **ENTER** button.
4. When you are satisfied with your setting, press the **ENTER** button.
5. Press the **EXIT** button to exit.

- ◆ **Programme** (Programme number to be assigned to a channel)
 - Press the **▲** or **▼** button until you find the correct number.
 - > You can also select the channel number directly by pressing the numeric buttons (0~9).
- ◆ **Colour System: Auto/PAL/SECAM/NTSC4.43/NTSC3.58**
 - Press the **▲** or **▼** button to select the required colour standard.
- ◆ **Sound System: BG/DK/I/M**
 - Press the **▲** or **▼** button to select the required sound standard.
- ◆ **Channel** (When you know the number of the channel to be stored)
 - Press the **▲** or **▼** button to select **C** (Air channel) or **S** (Cable channel).
 - Press the **►** button, then press the **▲** or **▼** button to select the required number.
 - > You can also select the channel number directly by pressing the numeric buttons (0~9).
 - > If there is abnormal sound or no sound, re-select the sound standard required.
- ◆ **Search** (When you do not know the channel numbers)
 - Press the **▲** or **▼** button to start the search.
 - The tuner scans the frequency range until the first channel or the channel that you selected is received on the screen.

- ◆ **Store** (When you store the channel and associated programme number)
 - Set to "OK" by pressing the **ENTER** button.

> Channel mode

- **P** (Programme mode): When completing tuning, the broadcasting stations in your area have been assigned to position numbers from P00 to P99. You can select a channel by entering the position number in this mode.
- **C** (Air channel mode): You can select a channel by entering the assigned number to each air broadcasting station in this mode.
- **S** (Cable channel mode): You can select a channel by entering the assigned number for each cable channel in this mode.

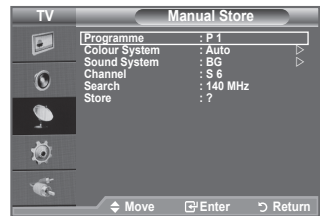

Adding / Locking Channels

Using the Channel Manager, you can conveniently lock or add channels.

1. Press the **MENU** button to display the menu.
Press the **▲** or **▼** button to select "Channel", then press the **ENTER** button.
2. Press the **▲** or **▼** button to select "Channel Manager", then press the **ENTER** button.

◆ Adding channels

Using the Channel List, you can add channels.

3. Select "Channel List" by pressing the **ENTER** button.
4. Move to the (⊕) field by pressing the **▲**, **▼**, **◀** or **▶** button, select a channel to be added, and press the **ENTER** button to add the channel.
 - If you press the **ENTER** button again, the (✓) symbol next to the channel disappears and the channel is not added.
 - "🔒" is active when "Child Lock" is selected to "On".

◆ Locking channels

This feature allows you to prevent unauthorized users, such as children, from watching unsuitable programmes by muting out video and audio.

5. Press the **▲** or **▼** button to select "Child Lock", then press the **ENTER** button.
6. Select "On" by pressing the **▲** or **▼** button, then press the **ENTER** button.
7. Press the **▲** or **▼** button to select "Channel List", then press the **ENTER** button.
8. Move to the "🔒" field by pressing the **▲**, **▼**, **◀** or **▶** button, select a channel to be locked, and press the **ENTER** button.
 - If you press the **ENTER** button again, the (✓) symbol next to the channel disappears and the channel lock is cancelled.
 - A blue screen is displayed when "Child Lock" is activated.
9. Press the **EXIT** button to exit.
 - Select "On" or "Off" in "Child Lock" to easily turn the channels which selected on "🔒" to be active or inactive.

 You can select these options by simply pressing the **CH LIST** button on the remote control.

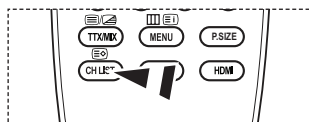
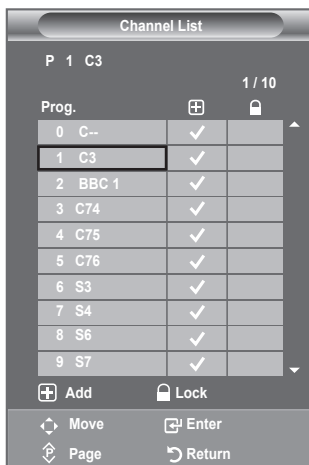

Sorting the Stored Channels

This operation allows you to change the programme numbers of the stored channels.

This operation may be necessary after using the auto store.

- Press the **MENU** button to display the menu.
Press the **▲** or **▼** button to select "Channel", then press the **ENTER** button.
- Press the **▲** or **▼** button to select "Sort", then press the **ENTER** button.
- Select the channel number that you wish to change by pressing the **▲** or **▼** button.
Press the **ENTER** button.
➤ The selected channel number and name are moved to right side.
- Select the number of the programme to which the channel is to be moved by pressing the **▲** or **▼** button.
- Press the **ENTER** button. The channel is moved to its new position and all other channels are shifted accordingly.
- Repeat steps 3 to 4 for another channel to be sorted.
- Press the **EXIT** button to exit.



Assigning Channels Names

Channel names will be assigned automatically when channel information is broadcast. These names can be changed, allowing you to assign new names.

- Press the **MENU** button to display the menu.
Press the **▲** or **▼** button to select "Channel", then press the **ENTER** button.
- Press the **▲** or **▼** button to select "Name", then press the **ENTER** button.
- If necessary, select the channel to be assigned to a new name by pressing the **▲** or **▼** button. Press the **ENTER** button.
➤ The selection bar is displayed around the name box.

To...	Then...
Select a letter, number or symbol	Press the ▲ or ▼ button
Move on the next letter	Press the ▶ button
Move back the previous letter	Press the ◀ button
Confirm the name	Press the ENTER button

➤ The following characters are available: Letters of the alphabet (A~Z) / Numbers (0~9) / Special characters (+, -, *, /, space)

- Repeat steps 3 to 4 for each channel to be assigned to a new name.
- Press the **EXIT** button to exit.



Fine Tuning Channel Reception

Use fine tuning to manually adjust a particular channel for optimal reception.

1. Use the number buttons to directly select the channel that you want to fine tune.
2. Press the **MENU** button to display the menu. Press the **▲** or **▼** button to select "Channel", then press the **ENTER** button.
3. Press the **▲** or **▼** button to select "Fine Tune", then press the **ENTER** button.
4. Press the **◀** or **▶** button to adjust the fine tuning. Press the **ENTER** button.
5. Press the **EXIT** button to exit.
 - Fine tuned channels that have been saved are marked with an asterisk "*" on the right-hand side of the channel number in the channel banner. And the channel number turns red.
 - To reset the fine-tuning, select "Reset" by pressing the **▲** or **▼** button and then press the **ENTER** button.



Changing the Picture Standard

You can select the type of picture which best corresponds to your viewing requirements.

1. Press the **MENU** button to display the menu.
Press the **ENTER** button, to select "Picture".
2. Press the **ENTER** button again, to select "Mode".
3. Press the **▲** or **▼** button to select the desired picture effect.
Press the **ENTER** button.
4. Press the **EXIT** button to exit.

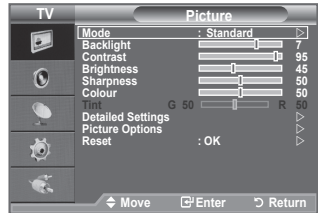

- ◆ **Dynamic:** Selects the picture for high-definition in a bright room.
- ◆ **Standard:** Selects the picture for optimum display in a normal environment.
- ◆ **Movie:** Selects the picture for comfortable display in a dark room.

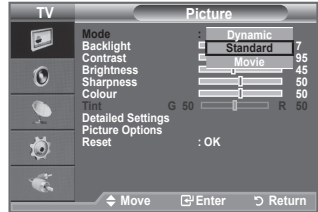

> The Picture mode must be adjusted separately for each input source.

- 📖 You can also press the **P.MODE** button on the remote control to select one of the picture settings.

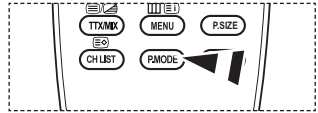

Easy Setting

1. Press the **TOOLS** button on the remote control.
2. Press the **▲** or **▼** button to select "Picture Mode".
3. Press the **◀** or **▶** button to select the required option.
4. Press the **EXIT** or **TOOLS** button to exit.

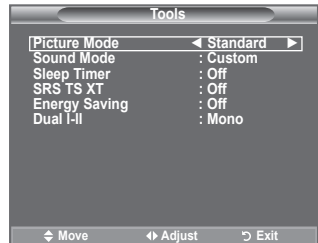

Adjusting the Custom Picture

Your set has several settings which allow you to control picture quality.

1. To select the desired picture effect, follow the "Changing the Picture Standard" instructions number 1 to 3. (On page 15)
2. Press the ▲ or ▼ button to select a particular item. Press the **ENTER** button.
3. Press the ◀ or ▶ button to decrease or increase the value of a particular item. Press the **ENTER** button.
4. Press the **EXIT** button to exit.

- ◆ **Backlight:** Adjusts the screen brightness by adjusting the LCD backlight brightness. (0~10)
- ◆ **Contrast:** Adjusts the lightness and darkness between objects and the background.
- ◆ **Brightness:** Adjusts the brightness of the whole screen.
- ◆ **Sharpness:** Adjusts the outline of objects to either sharpen them or make them more dull.
- ◆ **Colour:** Adjusts the colours, making them lighter or darker.
- ◆ **Tint:** Adjusts the colour of objects, making them more red or green for a more natural look.

- The adjusted values are stored according to the selected Picture mode.
- In PC mode, you can only make changes to "Backlight", "Contrast" and "Brightness".
- TV, AV, S-Video modes of the PAL system, you cannot use the "Tint" Function.
- You can return to the factory defaults picture settings by selecting the "Reset". (Refer to "Resetting the Picture Settings to the Factory Defaults" on page 17)
- The energy consumed during use can be significantly reduced if the level of brightness of the picture is reduced, and that this will reduce the overall running cost.

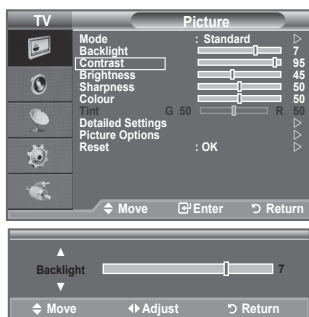

Configuring Detailed Settings on the Picture

You can set detailed picture settings.

1. Press the **MENU** button to display the menu. Press the **ENTER** button, to select "Picture".
2. Press the **ENTER** button to select "Mode". Press the ▲ or ▼ button to select "Standard" or "Movie", then press the **ENTER** button.
3. Press the ▲ or ▼ button to select "Detailed Settings", then press the **ENTER** button.
4. Select the required option by pressing the ▲ or ▼ button, then press the **ENTER** button.
5. When you are satisfied with your setting, press the **ENTER** button.
6. Press the **EXIT** button to exit.
 - "Detailed Settings" is available in "Standard" or "Movie" mode.
 - In PC mode, you can only make changes to "Dynamic Contrast", "Gamma" and "White Balance" from among the "Detailed Settings" items.

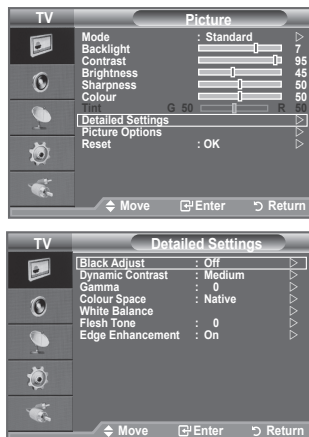

- ◆ **Black Adjust: Off/Low/Medium/High**
You can directly select the black level on the screen to adjust the screen depth.
- ◆ **Dynamic Contrast: Off/Low/Medium/High**
You can adjust the screen contrast so that the optimal contrast is provided.
- ◆ **Gamma: -3 ~ +3**
You can adjust the Primary Colour (Red, Green, Blue) Intensity.
Press the ◀ or ▶ button until you reach the optimal setting.
- ◆ **Colour Space: Auto/Native/Custom**
Colour space is a Colour matrix composed of red, green and blue colours.
Select your favourite Colour space to experience the most natural Colour.

- ◆ **Auto:** Auto Color Space automatically adjusts to the most natural color tone based on program sources.
- ◆ **Native:** Native Color Space offers deep and rich color tone.
- ◆ **Custom:** Adjusts the color range to suit your preference.

➤ Customizing the Colour Space

Colour: Red/Green/Blue/Yellow/Cyan/Magenta

Adjusts the Colour range to suit your preference.

"Colour" is available when "Colour Space" is set to "Custom".

Press the ▲ or ▼ button to select "Red", "Green", "Blue", "Yellow", "Cyan" or "Magenta".

Press the **ENTER** button.

Red/Green/Blue: In "Colour", you can adjust the RGB values for the selected colour.

Press the ▲ or ▼ button to select "Red", "Green" or "Blue" to change it. Press the **ENTER** button.

Press the ◀ or ▶ button to decrease or increase the value of a particular item.

Press the **ENTER** button.

Reset: Resets the colour space to the default values.

- ◆ **White Balance: R-Offset/G-Offset/B-Offset/R-Gain/G-Gain/B-Gain/Reset**

You can adjust the colour temperature for more natural picture colours.

R-Offset/G-Offset/B-Offset/R-Gain/G-Gain/B-Gain: Changing the adjustment value will refresh the adjusted screen.

Select the required option by pressing the ▲ or ▼ button, then press the **ENTER** button.

Press the ◀ or ▶ button until you reach the optimal setting.

Reset: The previously adjusted white balance will be reset to the factory defaults.

- ◆ **Flesh Tone: -15 ~ +15**

You can emphasize the pink 'flesh tone' in the picture.

Press the ◀ or ▶ button until you reach the optimal setting.

➤ Changing the adjustment value will refresh the adjusted screen.

- ◆ **Edge Enhancement: Off/On**

You can emphasize object boundaries in the picture.

Resetting the Picture Settings to the Factory Defaults

You can return to the factory defaults picture settings.

1. To select the desired picture effect, follow the "Changing the Picture Standard" instructions number 1 to 3 on page 15.
 2. Press the ▲ or ▼ button to select "Reset", then press the **ENTER** button.
 3. Press the ▲ or ▼ button to select "OK" or "Cancel".
Press the **ENTER** button.
 4. Press the **EXIT** button to exit.
- The "Reset" will be set for each Picture mode.

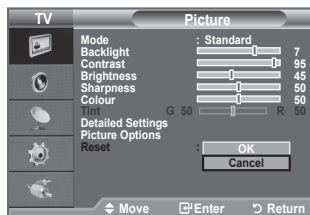

Changing the Picture Options



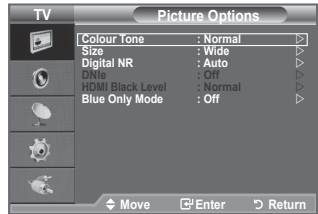
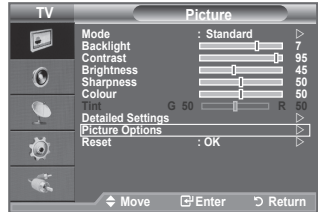

1. Press the **MENU** button to display the menu. Press the **ENTER** button, to select "Picture".
2. Press the **▲** or **▼** button to select "Picture Options", then press the **ENTER** button.
3. Select the required option by pressing the **▲** or **▼** button, then press the **ENTER** button.
4. When you are satisfied with your setting, press the **ENTER** button.
5. Press the **EXIT** button to exit.
 - In PC mode, you can only make changes to the "Colour Tone" and "Size" from among the items in "Picture Options".



- ◆ **Colour Tone: Cool2/Cool1/Normal/Warm1/Warm2**
You can select the most comfortable colour tone to your eyes.
 - The adjusted values are stored according to the selected Picture mode.
 - "Warm1" or "Warm2" is only activated when the picture mode is "Movie".

- ◆ **Size: Wide/16:9/Wide Zoom/Zoom/4:3/Just Scan**
You can select the picture size which best corresponds to your viewing requirements.

- ◆ **Wide:** Adjusts the picture size to Wide appropriate for DVDs or wide broadcasting.
- ◆ **16:9:** Adjusts the picture size to 16:9 appropriate for DVDs or wide broadcasting.
- ◆ **Wide Zoom:** Magnify the size of the picture more than 4:3.
- ◆ **Zoom:** Magnifies the 16:9 wide picture (in the vertical direction) to fit the screen size.
- ◆ **4:3:** This is the default setting for a video movie or normal broadcasting.
- ◆ **Just Scan:** Use the function to see the full image without any cutoff when HDMI (720p/1080i) or Component (1080i) signals are input.

- In PC Mode, only "Wide" and "4:3" mode can be adjusted.
- Settings can be adjusted and stored for each external device you have connected to an input of the TV.
- Temporary image retention may occur when viewing a static image on the set for more than two hours.
- **Wide Zoom:** Move the screen up/down using the **▲** or **▼** button after selecting the  by pressing the **▶** or **ENTER** button.
- **Zoom:** Select  by pressing the **◀** or **▶** button. Use the **▲** or **▼** button to move the picture up and down. After selecting , use the **▲** or **▼** button to magnify or reduce the picture size in the vertical direction.
- **After selecting "Just Scan" in HDMI (1080i) or Component (1080i) mode:**
Select  by pressing the **◀** or **▶** button. Use the **▲**, **▼**, **◀** or **▶** button to move the picture.
Reset: Press the **◀** or **▶** button to select "Reset", then press the **ENTER** button. You can initialize the setting.

- 🔍 You can select these options by simply pressing the **P.SIZE** button on the remote control.

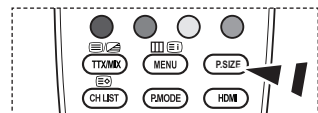

◆ **Digital NR: Off/Low/Medium/High/Auto**

If the broadcast signal received by your TV is weak, you can activate the Digital Noise Reduction feature to help reduce any static and ghosting that may appear on the screen.

➤ When the signal is weak, select one of the other options until the best picture is displayed.

◆ **DNle: Off/Demo/On**

This TV includes the DNle function so as to provide a high visual quality. If you set DNle to on, you can view the screen with the DNle feature activated. If you set the DNle to Demo, you can view the applied DNle and normal pictures on the screen, for demonstration purposes. Using this function, you can view the difference in the visual quality.

➤ DNle™ (Digital Natural Image engine) **DNle™**

This feature brings you more detailed image with 3D noise reduction, detail enhancement, contrast enhancement and white enhancement. New image compensation Algorithm gives brighter, clearer, more detailed image to you. DNle™ technology will fit every signal into your eyes.

➤ “DNle” is only available in “Dynamic” mode.

◆ **HDMI Black Level: Normal/Low**

You can select the black level on the screen to adjust the screen depth.

➤ This function is active only when the external input connects to HDMI(RGB signals).

◆ **Blue Only Mode: Off/On**

This function is for AV device measurement experts. This function displays the blue signal only by removing the red and green signals from the video signal so as to provide a Blue Filter effect that is used to adjust the Colour and Tint of video equipment such as DVD players, Home Theaters, etc.

Using this function, you can adjust the Colour and Tint to preferred values appropriate to the signal level of each video device using the Red/Green/Blue/Cyan/Magenta/Yellow Colour Bar Patterns, without using an additional Blue Filter.

➤ “Blue Only Mode” is available when the picture mode is set to “Movie” or “Standard”.

Viewing the Picture In Picture (PIP)

You can display a sub picture within the main picture of set programme or video input. In this way, you can watch the picture of set programme or video input from any connected equipment while watching the main picture.

1. Press the **MENU** button to display the menu.
Press the **▲** or **▼** button to select "Setup", then press the **ENTER** button.
 2. Press the **▲** or **▼** button to select "PIP", then press the **ENTER** button.
 3. Select the required option by pressing the **▲** or **▼** button, then press the **ENTER** button.
 4. When you are satisfied with your setting, press the **ENTER** button.
 5. Press the **EXIT** button to exit.
- You may notice that the picture in the PIP window becomes slightly unnatural when you use the main screen to view a game or karaoke.

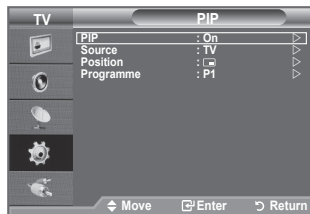
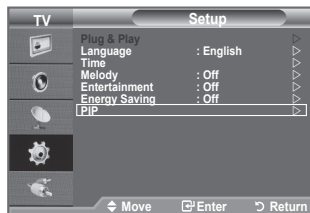

Easy Setting

1. Press the **TOOLS** button on the remote control.
2. Press the **▲** or **▼** button to select "PIP", then press the **ENTER** button.
3. Press the **▲** or **▼** button to select a particular item.
4. Press the **◀** or **▶** button to select the required option.
5. Press the **EXIT** or **TOOLS** button to exit.

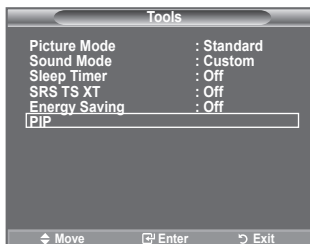

◆ PIP: On/Off

You can activate or deactivate the PIP function.

Main picture	Sub picture
Component 1, 2	TV, AV
HDMI	TV, AV
PC	TV, AV

◆ Source

You can select a source of the sub-picture.

◆ Position: / / /

You can select a position of the sub-picture.

◆ Programme

You can select a channel of the sub-picture only when the "Source" is set to "TV".

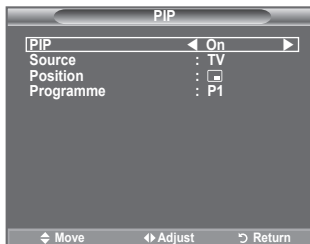

Sound Features

1. Press the **MENU** button to display the menu.
Press the **▲** or **▼** button to select "Sound", then press the **ENTER** button.
2. Select the required option by pressing the **▲** or **▼** button, then press the **ENTER** button.
3. When you are satisfied with your setting, press the **ENTER** button.
4. Press the **EXIT** button to exit.

◆ **Mode: Standard/Music/Movie/Speech/Custom**

You can select the type of special sound effect to be used when watching a given broadcast.

Easy Setting

1. Press the **TOOLS** button on the remote control.
2. Press the **▲** or **▼** button to select "Sound Mode".
3. Press the **◀** or **▶** button to select the desired sound mode.
4. Press the **EXIT** or **TOOLS** button to exit.

◆ **Equalizer: Balance/100Hz/300Hz/1kHz/3kHz/10kHz**

The sound settings can be adjusted to suit your personal preferences.

➤ If you make any changes to these settings, the sound mode is automatically switched to "Custom".

◆ **SRS TS XT: Off/On**

TruSurround XT is a patented SRS technology that solves the problem of playing 5.1 multichannel content over two speakers. TruSurround delivers a compelling, virtual surround sound experience through any two-speaker playback system, including internal television speakers. It is fully compatible with all multichannel formats.

Easy Setting

1. Press the **TOOLS** button on the remote control.
2. Press the **▲** or **▼** button to select "SRS TS XT".
3. Press the **◀** or **▶** button to select the "Off" or "On".
4. Press the **EXIT** or **TOOLS** button to exit.

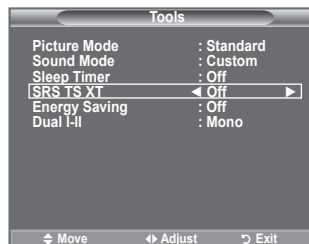
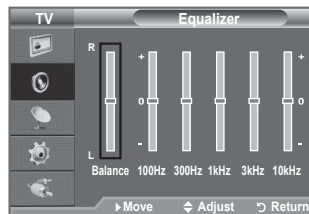
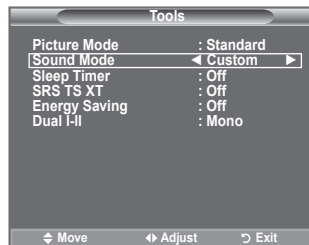
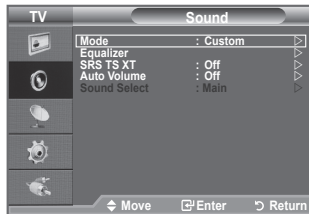

TruSurround XT, SRS and  Symbol are trademarks of SRS Labs, Inc. TruSurround XT technology is incorporated under license from SRS Labs, Inc.

◆ **Auto Volume: Off/On**

Each broadcasting station has its own signal conditions, and so it is not easy to adjust the volume every time the channel is changed. This feature lets you automatically adjust the volume of the desired channel by lowering the sound output when the modulation signal is high or by raising the sound output when the modulation signal is low.

◆ **Sound Select: Main/Sub**

When the PIP feature is activated, you can listen to the sound of the sub (PIP) picture.

- **Main:** Used to listen to the sound of the main picture.
- **Sub:** Used to listen to the sound of the sub picture.

Selecting the Sound Mode

You can set the sound mode in the "Tools" menu. When you set to "Dual I-II", the current sound mode is displayed on the screen.

1. Press the **TOOLS** button on the remote control.
2. Press the **▲** or **▼** button to select "Dual I-II".
3. Press the **◀** or **▶** button to select required option.
4. Press the **ENTER** button.

	Audio Type	Dual 1/2	Default
A2 Stereo	Mono	MONO	Automatic change
	Stereo	STEREO ↔ MONO	
	Dual	DUAL 1 ↔ DUAL 2	DUAL 1
NICAM Stereo	Mono	MONO	Automatic change
	Stereo	MONO ↔ STEREO	
	Dual	↖ MONO ↔ DUAL 1 ↗ ↘ DUAL 2 ↙	DUAL 1

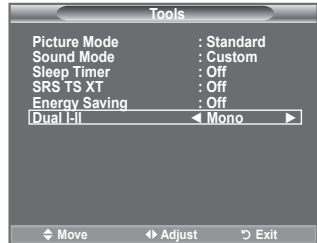

- If the stereo signal is weak and an automatic switching occurs, then switch to the Mono.
- This function is only activated in stereo sound signal. It is deactivated in mono sound signal.
- This function is only available in TV mode.

Connecting Headphones (Sold separately)

You can connect a set of headphones to your set if you wish to watch a TV programme without disturbing the other people in the room.

- When you insert the head set jack into the corresponding port, you can operate only "Auto Volume" and "Sound Select"(in PIP mode) in Sound menu.
- Prolonged use of headphones at a high volume may damage your hearing.
- You will not receive sound from the speakers when you connect headphones to the system.
- The headphone volume and TV volume are adjusted differently.



Setting and Displaying the Current Time

You can set the TV's clock so that the current time is displayed when you press the INFO button. You must also set the time if you wish to use the automatic On/Off timers.

1. Press the **MENU** button to display the menu.
Press the **▲** or **▼** button to select "Setup", then press the **ENTER** button.
2. Press the **▲** or **▼** button to select "Time", then press the **ENTER** button.
3. Press the **ENTER** button to select "Clock Set".

To...	Press the...
Move to "Month", "Day", "Year", "Hour" "Minute" or "am/pm"	◀ or ▶ button.
Set the "Month", "Day", "Year", "Hour" "Minute" or "am/pm"	▲ or ▼ button.
Confirm the setting	ENTER button.

5. Press the **EXIT** button to exit.

- > If you disconnect the power cord, you have to set the clock again.
- > You can also set "Year", "Month", "Day", "Hour" and "Minute" by pressing the number buttons on the remote control.

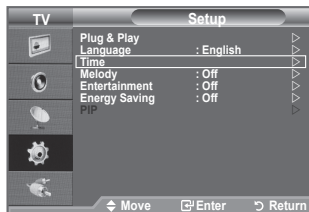

Setting the Sleep Timer

You can select a time period of between 30 and 180 minutes after which the television automatically switches to standby mode.

1. Press the **MENU** button to display the menu.
Press the **▲** or **▼** button to select "Setup", then press the **ENTER** button.
 2. Press the **▲** or **▼** button to select "Time", then press the **ENTER** button.
 3. Press the **▲** or **▼** button to select "Sleep Timer", then press the **ENTER** button.
 4. Press the **▲** or **▼** button repeatedly until the desired time appears (Off, 30, 60, 90, 120, 150, 180).
Press the **ENTER** button.
 5. Press the **EXIT** button to exit.
- > The TV automatically switches to standby mode when the timer reaches 0.

Easy Setting

1. Press the **TOOLS** button on the remote control.
2. Press the **▲** or **▼** button to select "Sleep Timer".
3. Press the **◀** or **▶** button to select the minute.
4. Press the **EXIT** or **TOOLS** button to exit.

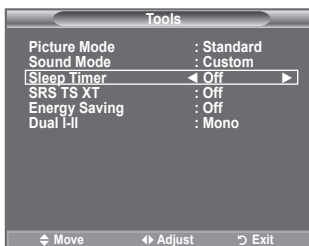
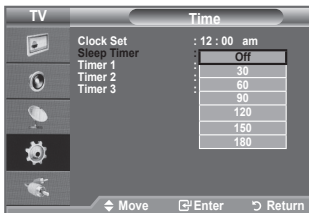
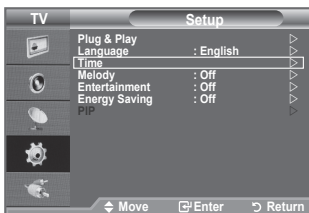

Switching the Television On and Off Automatically

1. Press the **MENU** button to display the menu.
Press the **▲** or **▼** button to select "Setup", then press the **ENTER** button.
 2. Press the **▲** or **▼** button to select "Time", then press the **ENTER** button.
 3. Press the **▲** or **▼** button to select "Timer 1", "Timer 2", "Timer 3", then press the **ENTER** button.
Three different On/Off Timer Settings can be made.
➤ You must set the clock first.
 4. Press the **◀** or **▶** button to select the required item below.
Press the **▲** or **▼** button to adjust to the setting satisfied.
 - ♦ **On Time:** Select hour, minute, am/pm and "On"/"Off". (To activate timer with the setting satisfied, set to "On".)
 - ♦ **Off Time:** Select hour, minute, am/pm and "On"/"Off". (To activate timer with the setting satisfied, set to "On".)
 - ♦ **Repeat:** Select "Once", "Everyday", "Mon~Fri", "Mon~Sat", or "Sat~Sun".
 - ♦ **Volume:** Select the desired turn on volume level.
 - ♦ **Programme:** When the On Timer is active, you can turn on a specific channel.
- You can set the hour, minute and Programme directly by pressing the number buttons on the remote control.
- **Auto Power Off**
When you set the timer On, the TV will eventually turn off, if no controls are operated for 3 hours after the TV was turned on by timer. This function is only available in timer On mode and prevents overheating, which may occur if a TV is on for too long time.

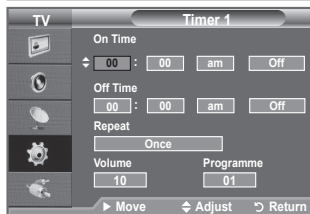
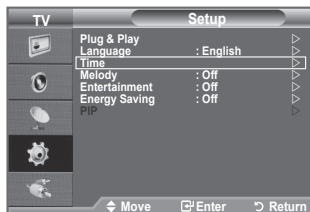

Choosing Your Language

When you start using your set for the first time, you must select the language which will be used for displaying menus and indications.

1. Press the **MENU** button to display the on-screen menu.
Press the **▲** or **▼** button to select "Setup", then press the **ENTER** button.
2. Press the **▲** or **▼** button to select "Language", then press the **ENTER** button.
3. Select a particular language by pressing the **▲** or **▼** button repeatedly.
Press the **ENTER** button.
4. Press the **EXIT** button to exit.



Melody / Entertainment / Energy Saving

1. Press the **MENU** button to display the menu.
Press the **▲** or **▼** button to select "Setup", then press the **ENTER** button.
2. Select the required option by pressing the **▲** or **▼** button, then press the **ENTER** button.
3. When you are satisfied with your setting, press the **ENTER** button.
4. Press the **EXIT** button to exit.



◆ Melody: Off/Low/Medium/High

The TV power on/off melody sound can be adjusted.

➤ The Melody does not play

- When no sound is output from the TV because the **MUTE** button has been pressed
- When no sound is output from the TV because the **⊖** (Volume) button has been pressed
- When the TV is turned off by Sleep Timer function.

◆ Entertainment: Off/Sports/Cinema/Game

The "Entertainment" mode enables you to select the optimal display and sound for sports, cinema and games.

- **Off**: Switch the "Entertainment" function off.
- **Sports**: Provides the optimal picture and sound quality for sports. You can enjoy more thrilling Colour and sound.
- **Cinema**: Provides the optimal picture and sound quality for cinema. You can experience a richer picture and enhanced sound.
- **Game**: Provides the optimal picture and sound quality for games. This mode accelerates the playing speed when using an external game console connected to the TV.
- If you set any of the three "Entertainment" modes to On, the settings will be locked and can not be adjusted. If you want to make Picture and Sound mode adjustments, the "Entertainment" mode must be turned off.
- The "Entertainment" settings are saved for each input source.
- If you set any of the three "Entertainment" modes to On, "SRS TS XT" function is not available.

◆ Energy Saving: Off/Low/Medium/High/Auto

This feature adjusts the screen brightness depending on the surrounding lighting conditions.

- **Off**: Turns off the energy saving function.
- **Low**: Sets the TV to low energy saving mode.
- **Medium**: Sets the TV to medium energy saving mode.
- **High**: Sets the TV to high energy saving mode.
- **Auto**: Automatically adjusts the brightness of the TV screen in accordance with the scenes.

Easy Setting

1. Press the **TOOLS** button on the remote control.
2. Press the **▲** or **▼** button to select "Energy Saving".
3. Press the **◀** or **▶** button to select the "Off", "Low", "Medium", "High" or "Auto".
4. Press the **EXIT** or **TOOLS** button to exit.

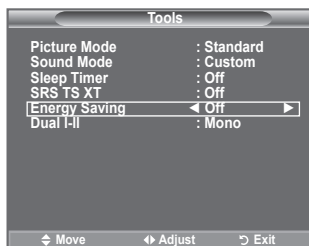

Selecting the Source

You can select among external sources connected to your TV's input jacks.

1. Press the **MENU** button to display the menu.
Press the **▲** or **▼** button to select "Input", then press the **ENTER** button.
2. Press the **ENTER** button again, to select "Source List".
 - > Available signal sources: TV, AV, S-Video, Component1, Component2, PC, HDMI
 - > You can choose only those external devices that are connected to the TV.
3. Select the required device by pressing the **▲** or **▼** button.
Press the **ENTER** button.

-  Press the **SOURCE** button on the remote control to toggle between all the available source.
TV mode can be selected by pressing the **TV** button, number buttons(0-9), and the **P**/**Q** button on the remote control.

-  You can also watch HDMI mode simply by pressing the **HDMI** button on the remote control.

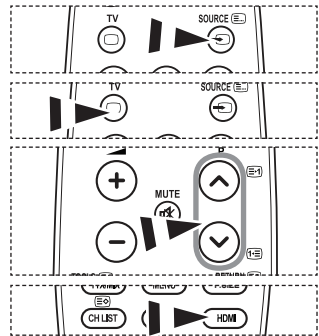

Editing the Input Source Names

Name the device connected to the input jacks to make your input source selection easier.

1. Press the **MENU** button to display the menu.
Press the **▲** or **▼** button to select "Input", then press the **ENTER** button.
2. Press the **▲** or **▼** button to select "Edit Name", then press the **ENTER** button.
3. Press the **▲** or **▼** button to select the device that you wish to edit.
Press the **ENTER** button.
4. Press the **▲** or **▼** button to select the required device.
Press the **ENTER** button.
5. Press the **EXIT** button to exit.



Setting up Your PC Software (Based on Windows XP)

The Windows display-settings for a typical computer are shown below. The actual screens on your PC may be different depending upon your particular version of Windows and your particular video card. Even if your actual screens look different, the same, basic set-up information will apply in almost all cases. (If not, contact your computer manufacturer or Samsung Dealer.)



1. First, click on "Control Panel" on the Windows start menu.
2. When the control panel window appears, click on "Appearance and Themes" and a display dialog-box will appear.
3. When the control panel window appears, click on "Display" and a display dialog-box will appear.
4. Navigate to the "Settings" tab on the display dialog-box.
The correct size setting (resolution): Optimum- 1680 X 1050
If a vertical-frequency option exists on your display settings dialog box, the correct value is "60" or "60 Hz". Otherwise, just click "OK" and exit the dialog box.

Display Modes

Both screen position and size will vary depending on the type of PC monitor and its resolution. The resolutions in the table are recommended.

> D-Sub Input

Mode	Resolution	Horizontal Frequency (kHz)	Vertical Frequency (Hz)	Pixel Clock Frequency (MHz)	Sync Polarity (H/V)
IBM	640 x 350	31.469	70.086	25.175	+/-
	720 x 400	31.469	70.087	28.322	+/
VESA	640 x 480	31.469	59.940	25.175	-/-
	640 x 480	37.861	72.809	31.500	-/-
	640 x 480	37.500	75.000	31.500	-/-
	800 x 600	37.879	60.317	40.000	+/+
	800 x 600	48.077	72.188	50.000	+/+
	800 x 600	46.875	75.000	49.500	+/+
	1024 x 768	48.363	60.004	65.000	-/-
	1024 x 768	56.476	70.069	75.000	-/-
	1024 x 768	60.023	75.029	78.750	+/+
	1280 x 1024	63.981	60.020	108.000	+/+
	1280 x 1024	79.976	75.025	135.000	+/+
	1360 x 768	47.712	60.015	85.500	+/+
	1680 x 1050RB	64.674	59.883	119.000	+/-

> HDMI/DVI Input

Mode	Resolution	Horizontal Frequency (kHz)	Vertical Frequency (Hz)	Pixel Clock Frequency (MHz)	Sync Polarity (H/V)
VESA	640 x 480	31.469	59.940	25.175	-/-
	800 x 600	37.879	60.317	40.000	+/+
	1024 x 768	48.363	60.004	65.000	-/-
	1280 x 1024	63.981	60.020	108.000	+/+
	1360 x 768	47.712	60.015	85.500	+/+
	1680 x 1050RB	64.674	59.883	119.000	+/-

- > When using an HDMI/DVI cable connection, you must use the HDMI IN / DVI IN jack.
- > The interlace mode is not supported.
- > The set might operate abnormally if a non-standard video format is selected.
- > Separate and Composite modes are supported. SOG is not supported.

Setting up the TV with your PC

➤ Preset: Press the **SOURCE** button to select PC mode.

1. Press the **MENU** button to display the menu. Press the **ENTER** button, to select "Picture".
2. Select the required option by pressing the **▲** or **▼** button, then press the **ENTER** button.
3. When you are satisfied with your setting, press the **ENTER** button.
4. Press the **EXIT** button to exit.

◆ Auto Adjustment

Auto adjustment allows the PC screen of set to self-adjust to the incoming PC video signal. The values of fine, coarse and position are adjusted automatically.

Easy Setting

1. Press the **TOOLS** button on the remote control.
2. Press the **▲** or **▼** button to select "Auto Adjustment", then press the **ENTER** button.

◆ Screen Adjustment: Coarse/Fine

The purpose of picture quality adjustment is to remove or reduce picture noise. If the noise is not removed by Fine-tuning alone, then adjust the frequency as best as possible (coarse) and Fine-tune again. After the noise has been reduced, re-adjust the picture so that it is aligned on the center of screen.

Press the **▲** or **▼** button to select "Coarse" or "Fine", then press the **ENTER** button.

Press the **◀** or **▶** button to adjust the screen quality.

Press the **ENTER** button.

Position

Adjust the PC's screen positioning if it does not fit the TV screen.

Press the **▲** or **▼** button to adjusting the Vertical-Position.

Press the **◀** or **▶** button to adjust the Horizontal-Position.

Press the **ENTER** button.

Image Reset

You can replace all image settings with the factory default values.

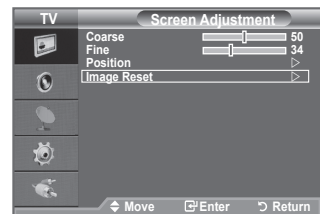
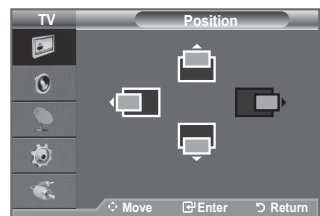
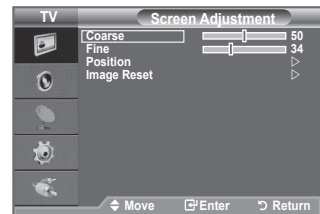
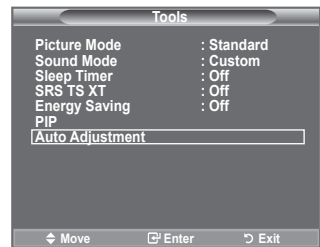
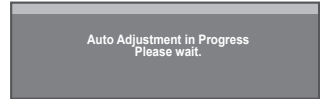
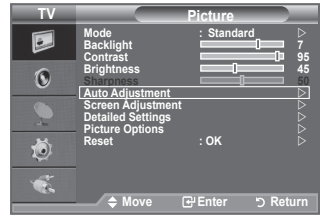

Teletext Feature

Most television stations provide written information services via Teletext. The index page of the teletext service gives you information on how to use the service. In addition, you can select various options to suit your requirements by using the remote control buttons.

> For teletext information to be displayed correctly, channel reception must be stable. Otherwise, information may be missing or some pages may not be displayed.

1  **(exit)**

Exit from the teletext display

2  **(size)**

Press to display the double-size letters in the upper half of the screen. For lower half of the screen, press it again. To display normal screen, press it once again.

3  **(reveal)**

Used to display the hidden text (answers to quiz games, for example). To display normal screen, press it again.

4 **Coloure buttons (red/green/yellow/blue)**

If the FASTEXT system is used by a broadcasting company, the different topics covered on a teletext page are colour-coded and can be selected by pressing the coloured buttons. Press one of them corresponding to the required. The page is displayed with other coloured information that can be selected in the same way. To display the previous or next page, press the corresponding coloured button.

5  **(teletext on/mix)**

Press to activate teletext mode after selecting the channel providing the teletext service. Press it twice to overlap the teletext with the current broadcasting screen.

6  **(store)**

Used to store the teletext pages.

7  **(mode)**

Press to select the teletext mode (LIST/FLOF). If you press it in the LIST mode, it switches into the List save mode. In the List save mode, you can save teletext page into list using the  (store) button.

8  **(sub-page)**

Used to display the available sub-page.

9  **(page up)**

Used to display the next teletext page.

10  **(page down)**

Used to display the previous teletext page.

11  **(hold)**

Used to hold the display on a given page if the selected page is linked with several secondary pages which follow on automatically. To resume, press it again.

12  **(cancel)**

Used to display the broadcast when searching for a page.

13  **(index)**

Used to display the index (contents) page at any time while you are viewing teletext.

> You can change teletext pages by pressing the numeric buttons on the remote control.

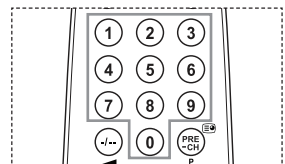
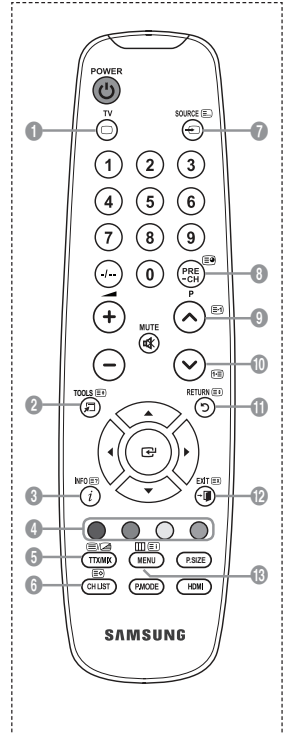

The teletext pages are organized according to six categories:

Part	Contents
A	Selected page number.
B	Broadcasting station identity.
C	Current page number or search status.
D	Date and time.
E	Text.
F	Status information. FASTEXT information.

> Teletext information is often divided between several pages displayed in sequence, which can be accessed by:

- ◆ Entering the page number
- ◆ Selecting a title in a list
- ◆ Selecting a coloured heading (FASTEXT system)

 Press the TV button to exit from the teletext display.

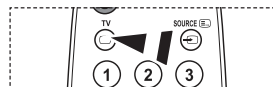
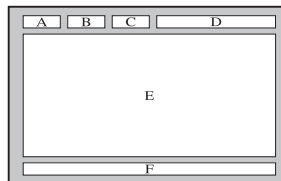



Using the Anti-Theft Kensington Lock (depending on the model)

The Kensington Lock is a device used to physically fix the system when using it in a public place. The appearance and locking method may differ from the illustration depending on the manufacturer. Refer to the manual provided with the Kensington Lock for proper use. The locking device has to be purchased separately.

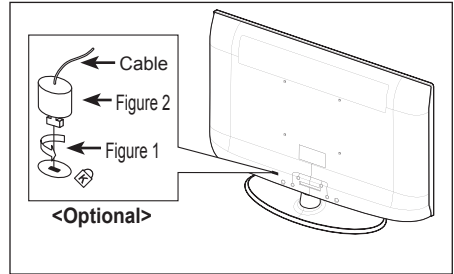
1. Insert the locking device into the Kensington slot on the LCD TV (Figure 1), and turn it in the locking direction (Figure 2).
 2. Connect the Kensington Lock cable.
 3. Fix the Kensington Lock to a desk or a heavy stationary object.
- The location of the Kensington Lock may be different depending on its model.



Troubleshooting: Before Contacting Service Personnel

No sound or picture.	<ul style="list-style-type: none"> ♦ Check that the mains lead has been connected to a wall socket. ♦ Check that you have pressed the  button on your set. ♦ Check the picture contrast and brightness settings. ♦ Check the volume.
Normal picture but no sound.	<ul style="list-style-type: none"> ♦ Check the volume. ♦ Check whether the MUTE  button has been pressed on the remote control.
Screen is black and power indicator light blinks steadily.	<ul style="list-style-type: none"> ♦ On your computer check; Power, Signal Cable. ♦ The TV is using its power management system. ♦ Move the computer's mouse or press any key on the keyboard.
No picture or black and white picture.	<ul style="list-style-type: none"> ♦ Adjust the colour settings. ♦ Check that the broadcast system selected is correct.
Sound and picture interference.	<ul style="list-style-type: none"> ♦ Try to identify the electrical appliance that is affecting the set and move it further away. ♦ Plug your set into a different mains socket.
Blurred or snowy picture, distorted sound.	<ul style="list-style-type: none"> ♦ Check the direction, location and connections of your aerial. This interference is often due to the use of an indoor aerial.
Remote control malfunctions.	<ul style="list-style-type: none"> ♦ Replace the remote control batteries. ♦ Clean the upper edge of the remote control (transmission window). ♦ Check the battery terminals.
'Check signal cable.' message is displayed.	<ul style="list-style-type: none"> ♦ Check that the signal cable is firmly connected to the PC or video sources. ♦ Check that the PC or video sources are turned on.
On PC mode, 'Not Supported Mode.' message is displayed.	<ul style="list-style-type: none"> ♦ Check the maximum resolution and the frequency of the video adaptor. ♦ Compare these values with the data in the Display Modes.
The damaged picture appears in the corner of the screen.	If "Just Scan" is selected in some external devices, the damaged picture may appear in the corner of the screen. This symptom is caused by external devices, not TV.
The 'Resets all settings to the default values' message appears.	This appears when you press and hold the EXIT button for a while. The product settings are reset to the factory defaults.

The TFT LCD panel uses a panel consisting of sub pixels (5 292 000) which require sophisticated technology to produce. However, there may be few bright or dark pixels on the screen. These pixels will have no impact on the performance of the product.

Technical and Environmental Specifications

Model Name	LA22A450
Screen Size (Diagonal)	22 inch
PC Resolution	1680 X 1050 @ 60 Hz
Sound Output	3W x 2
Dimensions (WxDxH)	
Body	558 X 67 X 407 mm
With stand	558 X 216 X 453 mm
Weight	
With stand	7 kg
Environmental Considerations	
Operating Temperature	10 °C to 40 °C (50 °F to 104 °F)
Operating Humidity	10 % to 80 %, non-condensing
Storage Temperature	-20 °C to 45 °C (-4 °F to 113 °F)
Storage Humidity	5 % to 95 %, non-condensing
Stand Swivel (Left / Right)	0°

- Design and specifications are subject to change without prior notice.
- This device is a Class B digital apparatus.
- For the power supply and Power Consumption, refer to the label attached to the product.