



LCD-TV

Chassis : N82A

Model : LA32C550J1F

LA37C550J1F

LA40C550J1F

LA46C550J1F

LA32C530F1R

LA37C530F1R

LA40C530F1R

LA46C530F1R

SERVICE Manual

TFT-LCD TV



LA32C550J1F/LA37C550J1F
LA40C550J1F/LA46C550J1F
LA32C530F1R/LA37C530F1R
LA40C530F1R/LA46C530F1R

Contents

1. Precautions
2. Product specifications
3. Disassembly and Reassembly
4. Troubleshooting
5. Exploded View & Part List
6. Wiring Diagram

Contents

1. Precautions	1-1
1-1. Safety Precautions	1-1
1-2. Servicing Precautions	1-2
1-3. Electrostatically Sensitive Devices (ESD) Precautions	1-2
1-4. Installation Precautions	1-3
2. Product specifications	2-1
2-1. Feature & Specifications	2-1
2-2. New Features explanation	2-8
2-3. Specification Comparison to Old Models	2-9
2-4. Accessories	2-10
3. Disassembly and Reassembly	3-1
3-1. Disassembly and Reassembly (LC550)	3-1
3-2. Disassembly and Reassembly (LC530)	3-3
4. Troubleshooting	4-1
4-1. Troubleshooting	4-1
4-2. Alignments and Adjustments	4-26
4-3. Factory Mode Adjustments	4-27
4-4. White Balance - Calibration	4-39
4-5. White Ratio (Balance) Adjustment	4-39
4-6. Servicing Information	4-40
4-7. How To Upgrade Sub Micom With Ddc Manager	4-41
4-8. Mechanical diagram	4-43
4-9. PCB diagram	4-44
5. Exploded View & Part List	5-1
5-1. Exploded View	5-1
5-2. Parts List	5-3
6. Wiring Diagram	6-1
6-1. Wiring Diagram	6-1
6-2. Connector	6-3
6-3. Connector Functions	6-5
6-4. Cables	6-5



GSPN (Global Service Partner Network)

Area	Web Site
North America	http://service.samsungportal.com
Latin America	http://latin.samsungportal.com
CIS	http://cis.samsungportal.com
Europe	http://europe.samsungportal.com
China	http://china.samsungportal.com
Asia	http://asia.samsungportal.com
Mideast & Africa	http://mea.samsungportal.com

This Service Manual is a property of Samsung Electronics Co.,Ltd.
Any unauthorized use of Manual can be punished under applicable
International and/or domestic law.

© 2010 Samsung Electronics Co.,Ltd.
All rights reserved.
Printed in China
P/N: BN82-00873A-00





3. Disassembly and Reassembly

This section of the service manual describes the disassembly and reassembly procedures for the LC550(LA32C550***) LCD TV.



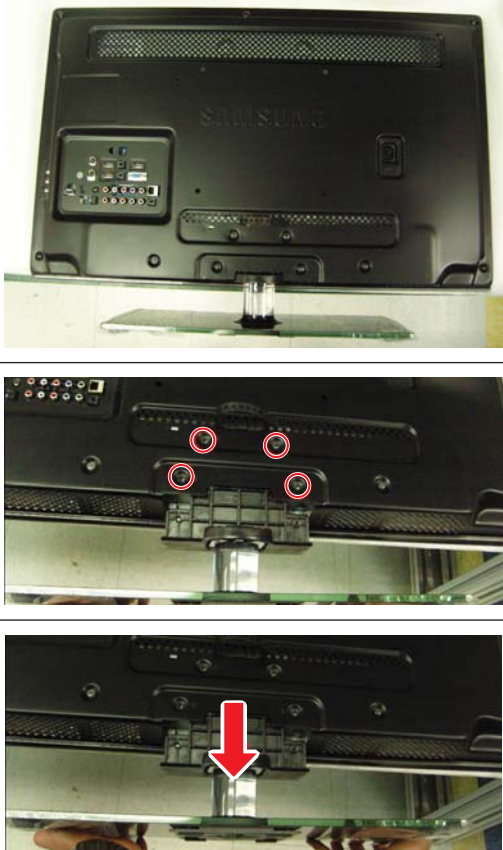



⚠ WARNING: This LCD TV contains electrostatically sensitive devices. Use caution when handling these components.

3-1. Disassembly and Reassembly (LC550)

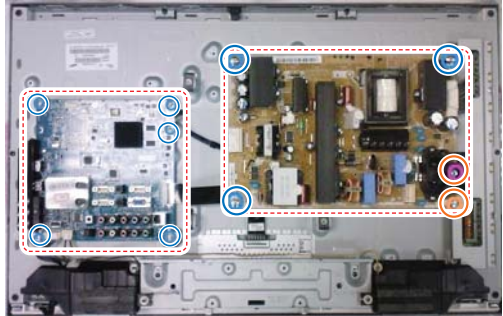
- ⚠ Cautions:**
1. Disconnect the LCD TV from the power source before disassembly.
 2. Follow these directions carefully; never use metal instruments to pry apart the cabinet.

Description	Picture Description	Screws
<p>1. Place the TV face down on cushioned table. Remove 4 screws from the Stand. Remove stand.</p>		 6003-001003
<p>2. Remove the screws of rear-cover. 32" : Remove the 8 screws of rear-cover. 37" : Remove the 12 screws of rear-cover. 40" : Remove the 10 screws of rear-cover. 46" : Remove the 13 screws of rear-cover.</p>		 6003-001003
<p>3. Lift up the rear-cover.</p>		

3. Disassembly and Reassembly

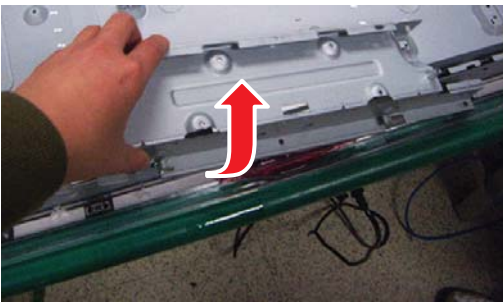
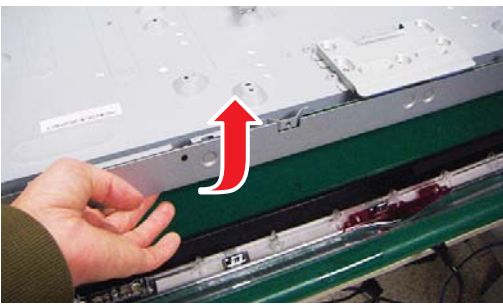



Description	Picture Description	Screws
4. Remove the left and right speaker.		
5. Remove the 5 screws of main board. Remove the screws of SMPS board. 32", 37" : Remove the 5 screws of rear-cover. 40", 46" : Remove the 7 screws of rear-cover.		 6001-002284  6001-002604
6. Remove the 5 screws of bracket stand link.	 	 6003-000337  6003-001003
7. Lift up the stand link.		
8. Lift up the panel.		

※ Reassembly procedures are in the reverse order of disassembly procedures.



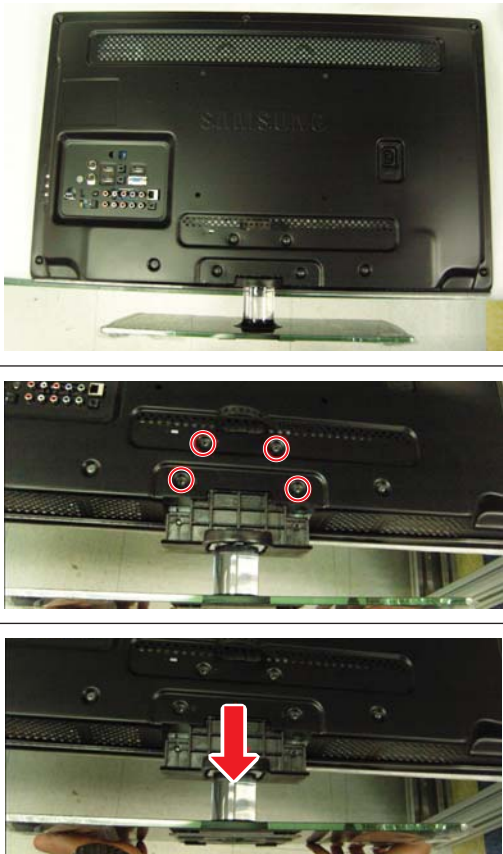



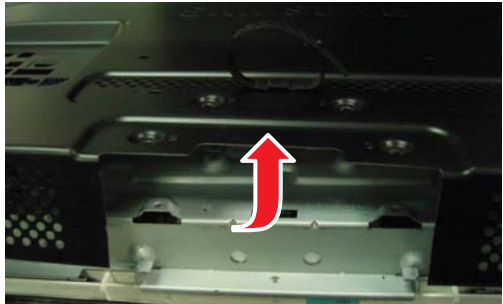

This section of the service manual describes the disassembly and reassembly procedures for the LC550(LA32C550***) LCD TV.
 ⚠ **WARNING:** This LCD TV contains electrostatically sensitive devices. Use caution when handling these components.

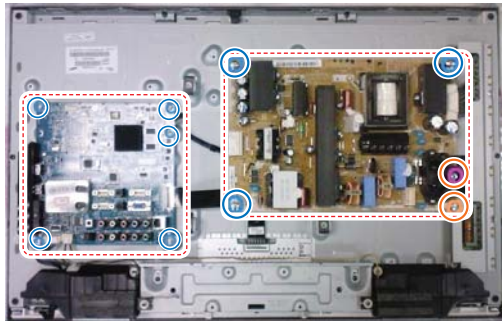
3-2. Disassembly and Reassembly (LC530)

- ⚠ **Cautions:**
1. Disconnect the LCD TV from the power source before disassembly.
 2. Follow these directions carefully; never use metal instruments to pry apart the cabinet.

Description	Picture Description	Screws
<p>1. Place the TV face down on cushioned table. Remove 4 screws from the Stand. Remove stand.</p>		 6003-001003
<p>2. Remove the screws of rear-cover. 32" : Remove the 8 screws of rear-cover. 37" : Remove the 12 screws of rear-cover. 40" : Remove the 10 screws of rear-cover. 46" : Remove the 13 screws of rear-cover.</p>		 6003-001003
<p>3. Lift up the rear-cover.</p>		

3. Disassembly and Reassembly

Description	Picture Description	Screws
4. Remove the left and right speaker.		
5. Remove the 5 screws of main board. Remove the screws of SMPS board. 32", 37" : Remove the 5 screws of rear-cover. 40", 46" : Remove the 7 screws of rear-cover.		 <p>6001-002284</p>  <p>6001-002604</p>
6. Remove the 5 screws of bracket stand link.	 	 <p>6003-000337</p>  <p>6003-001003</p>
7. Lift up the stand link.		

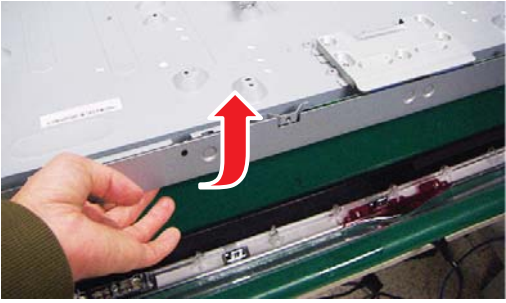
Description	Picture Description	Screws
8. Lift up the panel.		

※ Reassembly procedures are in the reverse order of disassembly procedures.

5. Exploded View & Part List

5-1. LA32C550J1F Exploded View

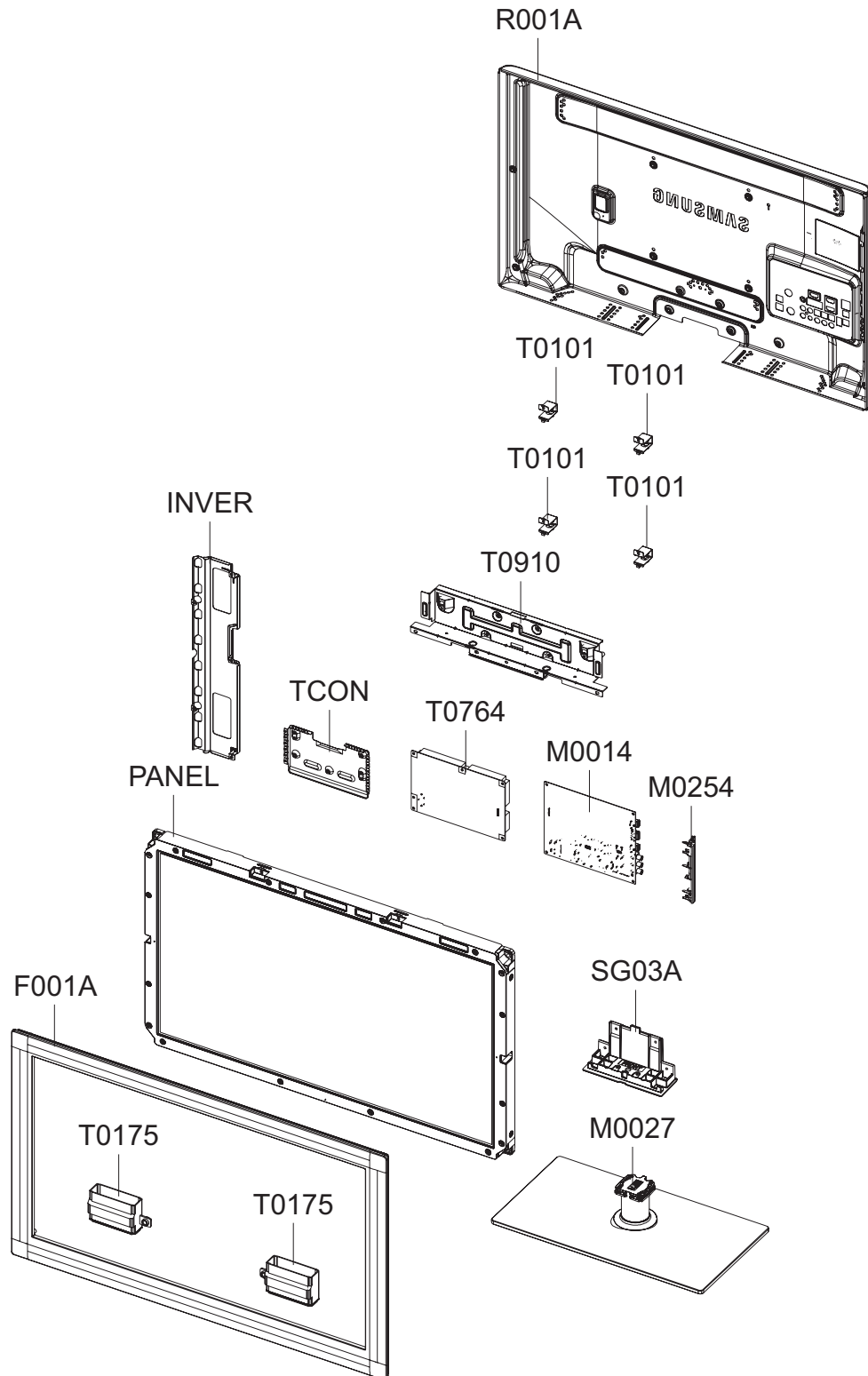

5-2. LA32C550J1F Parts List

Location No.	Code No.	Description & Specification	Q'ty	SA/SNA	Remark
F001A	BN96-12806E	ASSY COVER P-FRONT;32,LC550,CHINA(DTV),P	1	SA	
T0175	BN96-12871A	ASSY SPEAKER P;6ohm,4pin,10W,L:530 R:170	1	SA	
PANEL	BN07-00808A	LCD-PANEL;LTF320HM01,SSCZMS,8bit,31.5,16	1	SA	
TCON	BN81-04151A	A/S-T CON LTF320HM01;LTF320HM01	1	SA	
INVER	BN81-04167A	A/S-INVERTER LTF320HM01;LTF320HM01	1	SA	
T0764	BN44-00339A	SMPS-LCD TV;P3237F1_ASM,P3237F1_ASM,AC/D	1	SA	
M0014	BN94-03324A	ASSY PCB MAIN;SX1 550,DTV	1	SA	
M0254	BN61-06066B	HOLDER-SIDE AV;LC550,PMMA+ABS,HB,BK0007	1	SNA	
T0910	BN96-13341A	ASSY BRACKET P-STAND LINK;LC530 32,SECC,	1	SNA	
T0101	BN61-05996A	BRACKET-WALL;LC650 40,SECC,T1.2	4	SNA	
R001A	BN96-12765U	ASSY COVER P-REAR;32,LC530,XZ(DTV),PCM,T	1	SA	
SG03A	BN96-12758B	ASSY STAND P-GUIDE;32,LC650,W/W,PC+G/F,2	1	SA	
M0027	BN96-12761A	ASSY STAND P-BASE;32,EXPORT,TEMPERED GLA	1	SA	

5-2-1. LA32C550J1F Parts List

Service Bom (SA: SERVICE AVAILABLE, SNA: SERVICE NOT AVAILABLE)

Level	Location No.	Code No.	Description & Specification	Q'ty	SA/SNA	Remark
			LA32C550J1FXXZ			
0.1	S001A	BN90-02442B	ASSY STAND;32,LC650,W/W,2COAT,ROSE BLACK	1	SNA	
..2	SG03A	BN96-12758B	ASSY STAND P-GUIDE;32,LC650,W/W,PC+G/F,2	1	SA	
...3	T0524	6902-001048	BAG PE;LDPE,T0.05,W160,L300,TRP,4g	1	SNA	
...3	T0920	BN61-06002A	GUIDE-STAND;32,LC650,PC+G/F,20%,V2,BK000	1	SNA	
...3		BN68-02766B	MANUAL FLYER-STAND GUIDE;L550~L750,SAMSU	1	SNA	
...3		BN96-12031G	ASSY ACCESSORY-SCREW;10 LCD-TV,6003-0010	1	SNA	
...4	M0081	6003-001003	SCREW-TAPTYPE;BH,+ ,B,M4,L12,ZPC(BLK),SWR	9	SA	
...4	T0524	6902-000341	BAG PE;LDPE,T0.05,L90,W70,TRP,,,PE MARK	1	SNA	
..2	M0027	BN96-12761A	ASSY STAND P-BASE;32,EXPORT,TEMPERED GLA	1	SA	
...3	M0081	6003-001003	SCREW-TAPTYPE;BH,+ ,B,M4,L12,ZPC(BLK),SWR	3	SA	
...3		BN61-04692A	BOSS-PRIMER;#94,clear,35cps	0.1	SNA	
...3		BN61-04731C	BOSS-TAPE;AMBER,ACRYL,T1.1,W16.0mm,WHITE	0.29	SNA	
...3		BN61-04855A	BRACKET-SWIVEL BOTTOM;B650 40,SECC,T2.0	1	SNA	
...3		BN61-05254A	HOLDER-SWIVEL RING BOTTOM;LB700 40,POM H	1	SNA	
...3		BN61-05653A	BRACKET-STAND BOTTOM;B650 32,SECC,T2.0	1	SNA	
...3		BN61-05826A	BOSS-BOND;#760,Poly urethane,Black	2.4	SNA	
...3	GSN01	BN61-05993A	GUIDE-STAND NECK;32,LC650,PETG,V2,TP0003	1	SNA	
...4		BN61-06078B	GUIDE-NECK-INSERT;LC650 32,PETG HB,TP000	1	SNA	
...3	CCM1	BN63-04755A	COVER-SHEET;AMBER,PE,T0.05,W150mm,200M,6	1.1	SNA	
...3		BN63-05530D	COVER-STAND GLASS;32,LC650,GLASS,T8.0,2C	1	SNA	
...3	T0527	BN68-01648B	LABEL WARNING;WW,PET,T0.05,40,25,EXPORT	1	SNA	
...3	M0126	BN73-00215A	RUBBER-FOOT;40LB650,RUBBER,15*25,60,4.0,	4	SNA	
...3	M0126	BN73-00217A	RUBBER-FOOT;LB650,RUBBER,DIA30,7.5,Dark	4	SNA	
...3		BN74-00031A	GREASE;kanto-kasei FL-955,grease,wht	0.4	SNA	
...3	T0056	BN63-06908A	COVER-DECORATION;LB700 40,ABS+PMMA,HB,H/	1	SNA	
0.1	R001A	BN90-02446U	ASSY COVER REAR;32,LC650	1	SNA	
..2	M0081	6003-001003	SCREW-TAPTYPE;BH,+ ,B,M4,L12,ZPC(BLK),SWR	9	SA	
..2	R001A	BN96-12765U	ASSY COVER P-REAR;32,LC530,XZ(DTV),PCM,T	1	SA	
...3	R001	BN63-06392D	COVER-REAR;32,LC550,SO,PCM,T0.5,BLK	1	SNA	
...3		BN64-01270Q	INLAY-AV;LC550,CO,PS SHEET,T0.5	1	SNA	
...3	T0071	BN64-01297F	INLAY-TERMINAL;LC550,XZ(DTV),PS SHEET,T0	1	SNA	
...3	T0139	BN65-00003A	CLAMPER BAG;42C7,LDPE,HB,BLK	1	SNA	
...3	AH358	BN61-06544A	HOLDER-REAR;LC650 32,PP,BLK	1	SNA	
...3		BN60-00162X	SPACER-FOAM;FOAM,30000mm,Dark Gray,1T,15	1.77	SNA	
...3	M0131	BN63-03845A	GASKET;EMT4-10-4-110R-DM8,4T,10MM,100MM	4	SNA	
0.1		BN90-02472E	ASSY COVER FRONT;LA32C550J1FXXZ	1	SNA	
..2	F001A	BN96-12806E	ASSY COVER P-FRONT;32,LC550,CHINA(DTV),P	1	SA	
...3	AB326	BN61-04661A	BRACKET-STOPPER;L650,SK-5,T0.4,Plating,H	4	SNA	
...3	CCM1	BN63-02183F	COVER-SHEET;Rhcm,PE Vinyl,T0.04,900mm,20	0.67	SNA	
...3	CCM1	BN63-05199B	COVER-SHEET;AMBER,PE,T0.08,W65mm,200M,CL	1.87	SNA	
...3	CCM1	BN63-05199D	COVER-SHEET;AMBER,PE,T0.08,W75mm,200M,CL	0.83	SNA	
...3	F001	BN63-06384E	COVER-FRONT;32,LC550,CHINA(DTV),PMMA+PMM	1	SNA	
...3		BN96-12775B	ASSY HOLDER P-BOSS BOTTOM;32,LC630,ABS,H	1	SNA	
...4		BN61-04731A	BOSS-TAPE;AMBER,ACRYL,T1.1,W8.0mm,WHITE	0.37	SNA	
...4		BN61-05977B	HOLDER-BOSS BOTTOM;32,LC630,ABS,HB,WT003	1	SNA	
...3	M0125	BN96-13451B	ASSY BOARD P-TOUCH FUNCTION&IR;LN32C550J	1	SA	

5. Exploded View & Part List

Level	Location No.	Code No.	Description & Specification	Q'ty	SA/SNA	Remark
...3		BN60-00163A	SPACER-FOAM;LC650-32",FOAM,400,0.5,25,Bo	2	SNA	
...3		BN60-00163F	SPACER-FOAM;LC650-32",FOAM,750,T 0.5,22,	1	SNA	
...3		BN74-00052A	TAPE-PAPER;LB530,Crepe Paper,0.17mm, 10m	0.05	SNA	
..2	T0175	BN96-12871A	ASSY SPEAKER P;6ohm,4pin,10W,L:530 R:170	1	SA	
0.1		BN91-04886A	ASSY LCD-AMLCD;BN07-00808A	1	SNA	
..2	PANEL	BN07-00808A	LCD-PANEL;LTF320HM01,SSCZMS,8bit,31.5,16	1	SA	
...3	TCON	BN81-04151A	A/S-T CON LTF320HM01;LTF320HM01	1	SA	
...3	INVER	BN81-04167A	A/S-INVERTER LTF320HM01;LTF320HM01	1	SA	
0.1	M0017	BN91-05266A	ASSY CHASSIS;LC550,N82A	1	SNA	
..2	M0014	BN94-03324A	ASSY PCB MAIN;SX1 550,DTV	1	SA	
...3		0202-001608	SOLDER-WIRE FLUX;LFC7-107,D0.8,99.3Sn/0.	0.25	SNA	
...3		3701-001480	CONNECTOR-DSUB;15P,3R,FEMAIL,STAMPED PIN	1	SA	
...3		3711-007302	HEADER-BOARD TO BOARD;BOX,18P,2R,2mm,ANG	1	SA	
...3	ET01	BN40-00183A	TUNER;DNCS443VL161A(S),DTMB/PAL/NTSC,75o	1	SA	
...3	T0066	BN62-00040A	HEAT SINK-ES;SAPPHIRE,T2.0,36*36*6.6,BLK	1	SNA	
...3	M0412	BN96-11826C	ASSY BRACKET P-PCB;LB450 40,SPT E T0.5 +	1	SNA	
....4		BN61-04928C	BRACKET-SUPPORT PCB;SPT E,T 0.5,SCREW-M4	1	SNA	
....4		BN61-05262B	HOLDER-BOSS PCB;52,LB550(E0),PBT+G/F(30%	1	SNA	
...3		BN97-04052A	ASSY SMD-MAIN;SX1 550,DTV	1	SNA	
....4	DS01A	0401-001056	DIODE-SWITCHING;MMBD4148SE,100V,200mA,SO	16	SA	
....4		0403-001164	DIODE-ZENER;MMSZ5232B,5.32-5.88V,500MW,S	1	SA	
....4		0403-001783	DIODE-ZENER;BZB84-C6V2,5.8/6.6V,300mW,SO	15	SNA	
....4	D0254	0404-001271	DIODE-SCHOTTKY;SSA34,40V,3000mA,SMA,TP	1	SA	
....4	D0254	0404-001404	DIODE-SCHOTTKY;BAT721C,40V,200mA,SOT-23,	1	SA	
....4	T0139	0406-001200	DIODE-TVS;RCLAMP0504F,6/-/V,150W,SC-70	2	SA	
....4	T0139	0406-001271	DIODE-TVS;RCLAMP0524P,6/-/V,150W,SLP251	9	SNA	
....4	SD3	0407-000114	DIODE-SWITCHING;KDS184,80V,100mA,SOT-23,	3	SNA	
....4	Q101	0501-000445	TR-SMALL SIGNAL;KTC3875S-Y,NPN,150mW,SOT	8	SA	
....4	CEQ2	0505-000110	FET-SILICON;2N7002,N,60V,115mA,7.5ohm,0.	8	SA	
....4	Q409	0505-000274	FET-SILICON;AO4435L,P,-30V,-11A,0.014ohm	1	SNA	
....4	T0596	0904-002554	IC-USC;AU6256-JBF,QFN,28P,5x5mm,12MHz,TP	1	SA	
....4	IC106	1001-001573	IC-VIDEO SWITCH;SiI9287BCNUTR,QFN,72P,10	1	SNA	
....4		1006-001266	IC-LINE TRANSCEIVER;3232,TSSOP,16P,174MI	1	SA	
....4		1006-001474	IC-LINE DRIVER;DRV604PWP,HPSSOP,28P,9.8x	1	SA	
....4	IC112	1103-000129	IC-EEPROM;24C02,2Kbit,256x8,SOP,8P,5x4mm	2	SA	
....4	IC112	1103-001385	IC-EEPROM;AT24C256,256Kbit,32Kx8,SOP,8P,	1	SA	
....4		1105-002058	IC-DDR2 SDRAM;K4T1G164QE-HCF8,DDR2,1Gbit	2	SA	
....4	T0124	1201-002992	IC-POWER AMP;STA369BWS,PSSO,36P,10.3x7.5	1	SA	
....4	T0087	1203-001815	IC-POSIFIXED REG.;78M09,TO-252,3P,PLAST	1	SA	
....4	T0087	1203-002835	IC-POSIFIXED REG.;KIA7805AF,DPAK,3P,6.6	1	SA	
....4	T0087	1203-002898	IC-POSIFIXED REG.;G950T45R,TO-252,3P,6.	1	SA	
....4		1203-004364	IC-VOL. DETECTOR;RT9818C-42PV,SOT-23,3P,	1	SA	
....4	T0087	1203-005134	IC-POSIFIXED REG.;RT9167A-33PB,SOT-23-5	1	SNA	
....4		1203-005559	IC-BACKLIGHT DRIVER;MP3302DJ,TSOT23,5P,2	1	SA	
....4		1203-006013	IC-DC/DC CONVERTER;AOZ1031AI,SO-8,8P,4.9	2	SA	
....4		1203-006017	IC-VOL. DETECTOR;RT9824GJ8,TSOT23,8P,2.9	1	SA	
....4	T0087	1203-006135	IC-POSIFIXED REG.;AP1117D-33-GZ-13-89,T	1	SA	
....4	T0087	1203-006136	IC-POSIFIXED REG.;AP1117D-18-GZ-13-89,T	1	SA	
....4		1204-003096	IC-VIDEO DECODER;HIDTVPRO-SX,PBGA,580P,P	1	SA	
....4		1204-003117	IC-AUDIO PROCESSOR;MSP3455G,PMQFP,44P,13	1	SA	
....4		1205-003201	IC-BUS SWITCH;TC7WB125FK,SSOP,8P,2x2.3mm	2	SA	

5. Exploded View & Part List

Level	Location No.	Code No.	Description & Specification	Q'ty	SA/SNA	Remark
....4		1205-003733	IC-SWITCH;AP2191MPG-13,MSOP-8L-EP,8P,2.9	1	SA	
....4		1205-003735	IC-SWITCH;AP2151WG-7,SOT25,5P,2.9x1.6mm,	1	SA	
....4		1405-001185	VARISTOR;24Vdc,1.6x0.8x0.36mm,TP	1	SA	
....4		1405-001271	VARISTOR;20Vdc,5A,1.0x0.5x0.6mm,TP	25	SA	
....4	R105	2007-000138	R-CHIP;100ohm,5%,1/16W,TP,1005	33	SNA	
....4	AR49	2007-000140	R-CHIP;1Kohm,5%,1/16W,TP,1005	5	SNA	
....4	MR306	2007-000141	R-CHIP;2.2Kohm,5%,1/16W,TP,1005	11	SNA	
....4	R319	2007-000143	R-CHIP;4.7Kohm,5%,1/16W,TP,1005	53	SNA	
....4	R104	2007-000148	R-CHIP;10Kohm,5%,1/16W,TP,1005	38	SNA	
....4	R102	2007-000149	R-CHIP;12Kohm,5%,1/16W,TP,1005	8	SA	
....4	HDR9	2007-000152	R-CHIP;20Kohm,5%,1/16W,TP,1005	2	SNA	
....4	MR36	2007-000153	R-CHIP;22Kohm,5%,1/16W,TP,1005	5	SNA	
....4	AR43	2007-000155	R-CHIP;27Kohm,5%,1/16W,TP,1005	2	SNA	
....4	MR13	2007-000157	R-CHIP;47Kohm,5%,1/16W,TP,1005	7	SNA	
....4	R123	2007-000159	R-CHIP;56Kohm,5%,1/16W,TP,1005	1	SNA	
....4	DR39	2007-000162	R-CHIP;100Kohm,5%,1/16W,TP,1005	2	SNA	
....4	R509	2007-000170	R-CHIP;1Mohm,5%,1/16W,TP,1005	1	SNA	
....4	R111	2007-000171	R-CHIP;0ohm,5%,1/16W,TP,1005	11	SNA	
....4	HDR17	2007-000172	R-CHIP;10ohm,5%,1/16W,TP,1005	4	SNA	
....4	R338	2007-000173	R-CHIP;22ohm,5%,1/16W,TP,1005	12	SNA	
....4	MR9	2007-000455	R-CHIP;18Kohm,1%,1/10W,TP,1608	1	SA	
....4	ER13	2007-000669	R-CHIP;2Kohm,1%,1/10W,TP,1608	1	SNA	
....4	R726	2007-000695	R-CHIP;3.3ohm,5%,1/10W,TP,1608	1	SNA	
....4		2007-000755	R-CHIP;330Kohm,1%,1/10W,TP,1608	1	SA	
....4	R124	2007-000775	R-CHIP;33Kohm,5%,1/16W,TP,1005	3	SNA	
....4		2007-001285	R-CHIP;5.6ohm,5%,1/16W,TP,1005	4	SA	
....4	OTR1	2007-001292	R-CHIP;33ohm,5%,1/16W,TP,1005	4	SNA	
....4	R326	2007-001325	R-CHIP;3.3Kohm,5%,1/16W,TP,1005	11	SNA	
....4	TR30	2007-007009	R-CHIP;75ohm,5%,1/16W,TP,1005	11	SNA	
....4		2007-007134	R-CHIP;39Kohm,1%,1/16W,TP,1005	1	SA	
....4	DR4	2007-007142	R-CHIP;10Kohm,1%,1/16W,TP,1005	4	SNA	
....4		2007-007156	R-CHIP;1ohm,5%,1/16W,TP,1005	6	SNA	
....4		2007-007316	R-CHIP;3.3Kohm,1%,1/16W,TP,1005	1	SNA	
....4		2007-007318	R-CHIP;1Kohm,1%,1/16W,TP,1005	9	SNA	
....4		2007-007334	R-CHIP;200Kohm,1%,1/16W,TP,1005	4	SNA	
....4		2007-007698	R-CHIP;5.1Kohm,1%,1/16W,TP,1005	1	SNA	
....4	MR11	2007-008015	R-CHIP;75ohm,1%,1/16W,TP,1005	9	SNA	
....4		2007-008134	R-CHIP;12.4Kohm,1%,1/16W,TP,1005	2	SC	
....4		2007-008298	R-CHIP;49.9ohm,1%,1/16W,TP,1005	4	SA	
....4		2007-008593	R-CHIP;750ohm,1%,1/16W,TP,1005	1	SA	
....4	DAR09	2011-001262	R-NETWORK;22ohm,5%,1/16W,L,CHIP,8P,TP,2.	6	SA	
....4	DRP29	2011-001396	R-NETWORK;4.7Kohm,5%,1/16W,L,CHIP,8P,TP,	1	SA	
....4		2011-001448	R-NETWORK;10ohm,5%,1/16W,L,4P,T,1010	4	SA	
....4		2011-001449	R-NETWORK;22ohm,5%,1/16W,L,4P,TP,1010	5	SA	
....4		2011-001519	R-NETWORK;33OHM,5%,1/16W,L,CHIP,4P,TP,1.	3	SA	
....4		2011-001527	R-NETWORK;4.7Kohm,5%,1/16W,L,CHIP,4P,TP,	8	SNA	
....4		2011-001587	R-NETWORK;100ohm,5%,1/16W,L,CHIP-V,4P,TP	1	SNA	
....4		2011-001589	R-NETWORK;0ohm,5%,1/16W,L,CHIP-V,4P,TP,1	16	SNA	
....4	C4N08	2203-000140	C-CER,CHIP;1.5nF,10%,50V,X7R,1608	3	SNA	
....4	PC43	2203-000233	C-CER,CHIP;0.1nF,5%,50V,C0G,TP,1005	1	SA	
....4	MC302	2203-000425	C-CER,CHIP;.018nF,5%,50V,C0G,TP,1005	2	SA	

5. Exploded View & Part List

Level	Location No.	Code No.	Description & Specification	Q'ty	SA/SNA	Remark
...4	C254	2203-000438	C-CER,CHIP;1nF,10%,50V,X7R,TP,1005	13	SA	
...4	AC139	2203-000491	C-CER,CHIP;2.2nF,10%,50V,X7R,1608	2	SA	
...4	V1233	2203-000575	C-CER,CHIP;220nF,10%,25V,X7R,TP,2012	6	SNA	
...4	MC9	2203-000627	C-CER,CHIP;.022nF,5%,50V,C0G,TP,1005	3	SNA	
...4	DC25	2203-000812	C-CER,CHIP;.033nF,5%,50V,C0G,1005	9	SA	
...4	CK40B	2203-000838	C-CER,CHIP;0.39nF,5%,50V,C0G,TP,1608	3	SNA	
...4	AD480	2203-000995	C-CER,CHIP;.047nF,5%,50V,C0G,TP,1005	2	SA	
...4	HDC5	2203-001072	C-CER,CHIP;0.056nF,5%,50V,NP0,1005	4	SA	
...4	C101	2203-001124	C-CER,CHIP;0.68nF,10%,50V,X7R,TP,1005	1	SA	
...4	AD480	2203-001412	C-CER,CHIP;0.03nF,5%,50V,NP0,TP,1005	10	SNA	
...4	AD480	2203-001428	C-CER,CHIP;470nF,10%,50V,X7R,TP,2012	2	SNA	
...4	C637	2203-001656	C-CER,CHIP;0.47nF,5%,50V,NP0,1608	3	SNA	
...4	AD480	2203-002285	C-CER,CHIP;10nF,10%,50V,X7R,1005	14	SNA	
...4	AD480	2203-002525	C-CER,CHIP;0.56nF,10%,50V,X7R,TP,1005	8	SNA	
...4	AD480	2203-005052	C-CER,CHIP;0.0033nF,0.25pF,50V,NP0,1005	2	SA	
...4	AC611	2203-005194	C-CER,CHIP;.22nF,10%,50V,X7R,TP,1608	1	SA	
...4	AAC1	2203-005249	C-CER,CHIP;100nF,10%,50V,X7R,TP,1608	11	SNA	
...4	AD480	2203-005968	C-CER,CHIP;4.7nF,10%,50V,X7R,TP,1005	2	SNA	
...4	AD480	2203-006104	C-CER,CHIP;1000nF,10%,50V,X7R,3225	1	SA	
...4	PC11	2203-006141	C-CER,CHIP;1000nF,10%,16V,X5R,1608	1	SNA	
...4	C102	2203-006158	C-CER,CHIP;100nF,10%,16V,X7R,1005	115	SNA	
...4	JC10	2203-006324	C-CER,CHIP;2200nF,10%,10V,X5R,1608	2	SA	
...4	AD480	2203-006336	C-CER,CHIP;10000nF,10%,25V,X5R,3216	20	SA	
...4	C125	2203-006361	C-CER,CHIP;10000nF,10%,10V,X5R,TP,2012	48	SC	
...4	HDC11	2203-006562	C-CER,CHIP;1000nF,10%,10V,X5R,TP,1005	14	SNA	
...4	AD480	2203-006824	C-CER,CHIP;4700nF,10%,10V,X5R,1608	1	SNA	
...4	AD480	2203-006841	C-CER,CHIP;1000nF,10%,16V,X5R,1005	15	SNA	
...4	AD480	2203-006992	C-CER,CHIP;0.33nF,5%,50V,C0G,TP,1005	2	SNA	
...4	AD480	2203-007270	C-CER,CHIP;10000nF,10%,10V,X5R,TP,1608	3	SNA	
...4	T0052	2703-000158	INDUCTOR-SMD;1uH,10%,2012	9	SA	
...4	VL6	2703-000398	INDUCTOR-SMD;10uH,10%,3225	5	SA	
...4	T0052	2703-001239	INDUCTOR-SMD;3.3uH,10%,1608	1	SA	
...4	T0052	2703-001778	INDUCTOR-SMD;3.3uH,20%,3225	2	SA	
...4	T0052	2703-003149	INDUCTOR-SMD;2.2uH,20%,5050	3	SA	
...4	T0052	2703-003150	INDUCTOR-SMD;4.7uH,20%,5050	4	SNA	
...4	X202	2801-003326	CRYSTAL-SMD;24MHz,30ppm,28-ABX,20pF,50oh	1	SA	
...4	X202	2801-004300	CRYSTAL-SMD;18.432MHz,30ppm,28-ABX,13pF,	1	SA	
...4	X202	2801-004775	CRYSTAL-SMD;12MHz,30ppm,16pF,30ohm,TP	1	SNA	
...4	F103	2901-001506	FILTER-EMI SMD;5V,0.13A,0pF,2x1x0.5mm,TP	2	SA	
...4	T0568	3301-001236	BEAD-SMD;60ohm,1608	7	SNA	
...4	T0568	3301-002039	BEAD-SMD;26ohm,1608,TP	37	SA	
...4	T0313	3404-001207	SWITCH-TACT;12V,50mA,160gf,6.2X6.2,SPST	1	SA	
...4		3601-001374	FUSE-SURFACE MOUNT;32V,5A,FAST-ACTING,Hi	1	SNA	
...4		3701-001591	CONNECTOR-HDMI;19P,2ROW,FEMALE,SMD-S,AU	3	SNA	
...4	AC510	3708-002797	CONNECTOR-FPC/FFC/PIC;51P,0.50mm,SMD,AU,	1	SA	
...4		3710-002111	SOCKET-BOARD TO BOARD;60P,2R,0.5MM,SMD-S	1	SA	
...4	CON_US	3711-005616	HEADER-BOARD TO CABLE;BOX,10P,1R,2mm,SMD	1	SNA	
...4	HB01A	3711-007336	HEADER-BOARD TO CABLE;BOX,4P,1R,2.5mm,SM	1	SA	
...4		BN41-01407A	PCB MAIN;SA1,FR-4,4L,1.0,1.2T,192*195,SA	1	SNA	
...4	D0254	0402-000553	DIODE-SCHOTTKY;SS24/B240,40V,2000mA,DO-2	2	SA	
...4		2011-001427	R-NETWORK;0ohm,5%,1/16W,L,CHIP,8P,TP,2.0	1	SNA	

5. Exploded View & Part List

Level	Location No.	Code No.	Description & Specification	Q'ty	SA/SNA	Remark
...4	L1103	2703-000403	INDUCTOR-SMD;22uH,10%,3225	1	SA	
...4		1203-005538	IC-DC/DC CONVERTER;AOZ1021HAIL,SOP,8P,4.	1	SA	
...4		1203-006288	IC-VOL. DETECTOR;RT9818B-18GV,SOT-23-3,3	1	SA	
...4	PR6	2007-000072	R-CHIP;47ohm,5%,1/10W,TP,1608	4	SNA	
...4	HDR7	2007-000139	R-CHIP;220ohm,5%,1/16W,TP,1005	3	SNA	
...4		2007-007135	R-CHIP;18Kohm,1%,1/16W,TP,1005	1	SNA	
...4	C711	2203-002982	C-CER,CHIP;6.8nF,10%,50V,X7R,1005	1	SA	
...4	HE4	2203-006474	C-CER,CHIP;22000nF,20%,6.3V,X5R,2012	2	SA	
...4		BN97-04281A	ASSY MICOM;T-TDT5DEUS-1002,N82A,MX25L400	1	SNA	
....5	IC115	1107-001580	IC-FLASH MEMORY;MX25L4005,4Mbit,512Kx8,S	1	SNA	
...4		BN97-04282A	ASSY MICOM;T-TDT5DCNC-1002.0,N82A,KFG1G1	1	SNA	
....5		1107-001818	IC-NAND FLASH;KFG1G16U2C-DIB6,1024Mbit,6	1	SNA	
...4		0202-001767	SOLDER-CREAM;LST-5710,D20~38,Sn-57Bi-1Ag	0.409	SNA	
...4	HR3	2007-000903	R-CHIP;430ohm,1%,1/10W,TP,1608	1	SNA	
...4		2007-001317	R-CHIP;910ohm,5%,1/16W,TP,1005	1	SNA	
...4		2007-002768	R-CHIP;6.2Kohm,1%,1/10W,TP,1608	1	SA	
...4		2007-007317	R-CHIP;2.2Kohm,1%,1/16W,TP,1005	1	SA	
...4		2007-008275	R-CHIP;30Kohm,1%,1/16W,TP,1005	1	SNA	
...4	DC87	2203-001153	C-CER,CHIP;.068nF,5%,50V,NP0,1005	2	SA	
...4	T0052	2703-002268	INDUCTOR-SMD;8.2nH,5%,1005	4	SNA	
...4		3701-001693	CONNECTOR-HDMI;19P,2ROW,FEMALE,SMD-A	1	SA	
...4	AD480	2203-006144	C-CER,CHIP;4700nF,10%,16V,X7R,3216	1	SA	
...4	C	2402-001314	C-AL,SMD;100uF,20%,16V,WT,TP,6x5.8mm	1	SA	
...3	CN906	3707-001096	CONNECTOR-OPTICAL;STRAIGHT W/L,SPDIF	1	SA	
...3	M0254	BN61-06066B	HOLDER-SIDE AV;LC550,PMMA+ABS,HB,BK0007	1	SNA	
...3		3722-003037	JACK-USB;4P/1C W/L,AU/NI,BLK,ANGLE,A	1	SA	
...3	JA330	3722-003038	JACK-PHONE;7P/1C W/L,SN,BLK	2	SA	
...3	JA333	3722-003040	JACK-PIN;3P W/L,SN,BLK/YEL/WHT/RED,ANGLE	1	SA	
...3	JA333	3722-003052	JACK-PIN;5P+Shield W/L,NI/SN,GN/BL/RD/WH	2	SA	
...3		3722-003058	JACK-MODULAR;8P/8C W/L,Y,STRAIGHT,N,AU,1	1	SA	
...3		3722-003088	JACK-USB;4P/1C,NI/PD/AU/SN,GRY,STRAIGHT,	1	SA	
...3	M2893	BN39-01267A	LEAD CONNECTOR;LA32B450,UL 2651 AWG#26,1	1	SA	
0.1		BN92-05854A	ASSY P/MATERIAL;32,LC650	1	SNA	
..2	T0214	0203-001595	TAPE-OPP MASKING;OPP-2,0.075,75,800M,CLR	2.32	SNA	
..2		6902-000061	BAG AIR;LDPE,T0.2,W500,L1000,TRP,370.000	1	SNA	
..2		6902-000379	BAG AIR;LDPE,T0.2,W1000,L1800,TRP,1260.0	1	SNA	
..2	T0524	6902-000519	BAG PE;HDPE/NITRON,T0.015/T0.05(DOUBLE),	1	SNA	
..2		6902-000604	BAG WRAPPING;LDPE,T0.02,W500,L10000,TRP,	3.44	SNA	
..2		6902-000609	BAG ROLL;LDPE,T0.05,W2400,L1000,TRP,30.0	0.06	SNA	
..2	M040	6922-000013	BAND PP;PP,W18,L2300m,TRP,21000g	0.9	SNA	
..2		BN69-00391Q	PAD-ANGLE;T4,50,1800,YEL,400g	1	SNA	
..2	T0246	BN69-04323A	CUSHION-01,SET;32LC550/630/650/670,EPS,1	1	SNA	
..2		BN68-02422B	LABEL-WARNING SHIPPING;ALL MODEL,A/P 100	1	SNA	
..2		6902-001178	BAG SHEET;HDPE/NITRON,T0.015/T01.0,W400,	1	SNA	
0.1		BN92-05901E	ASSY BOX;LA32C550J1MXZK	1	SNA	
..2		BN69-04472G	BOX-SET;32LC550,CB,A-01,SW2,YEL,W1008,D1	1	SNA	
..2		BH68-00662A	LABEL BOX-00;ALL MODEL,MOJO 90G,60,110,W	1	SNA	
0.1	ACCE1	BN92-05928A	ASSY ACCESSORY;LA32C550J1FXXZ,N82A,LC550	1	SNA	
..2	ACCE2	BN96-13620A	ASSY ACCESSORY-CABLE;LA32C530F1MXZK,LC53	1	SNA	
...3	T0268	3903-000434	CBF-POWER CORD;DT,CN,IP3/YES,IEC320 C13-	1	SA	
...3	T0524	6902-001107	BAG PE;LDPE,T0.05,W450,L400,TRP,0,3Separ	1	SNA	

5. Exploded View & Part List

Level	Location No.	Code No.	Description & Specification	Q'ty	SA/SNA	Remark
...3	M9889	BN63-01798B	CLOTH-CLEAN;cloth,180,200,sea blue,ToC	1	SA	
...3	T0531	BN63-06389A	COVER-BOTTOM;32,LC530,HIPS,HB,BK0020	1	SA	
...3	T0527	BN68-00513A	LABEL-E,PASS;ALL MODEL,YUPO(110G),50X15,	1	SNA	
...3		BN43-00004A	BATTERY;BM1L,BATTERY,MN,600mAh,7.9g	2	SNA	
...3	REMO2	BN59-01017A	REMOCON;TM1050,SAMSUNG,20PIN SINGLE,48KE	1	SA	
...3		BN61-05596A	HOLDER-WIRE CABLE;LED TV,LDPE,T0.8,L150,	1	SNA	
...3	M0254	AA59-00416A	ANT SHIELD BOX;UGC-AS-001A,PAL-BG,DK,I,M	1	SA	
..2		BN96-13621A	ASSY ACCESSORY-MANUAL;LA32C550J1FXXZ,LC5	1	SNA	
...3	T0524	6902-000110	BAG PE;LDPE,T0.05,W250,L400,TRP,28,2,9.2	1	SNA	
...3	T0527	AA68-00764A	LABEL-PASSING;SAMSUNG ALL,ART PAPER,CLR,	1	SNA	
...3	T0527	AA68-02517A	LABEL;PJTV(TTSEC),COPPERPLATE,50,75,YELL	1	SNA	
...3	T0059	AA68-03184A	MANUAL FLYER-CARD-07;ALL MODEL,CHINESE,2	1	SNA	
...3	T0527	BN68-00513A	LABEL-E,PASS;ALL MODEL,YUPO(110G),50X15,	1	SNA	
...3		BN68-02186A	MANUAL FLYER-TOC GUIDE;COMM,SAMSUNG,11 L	1	SNA	
...3		BN68-02515A	MANUAL USERS;LC550&530&480&360,SAMSUNG,S	1	SNA	
0.1		BN92-05951A	ASSY LABEL;LA40C550J1FXXZ,LC550,N82A	1	SNA	
..2	T0527	BP68-00052B	LABEL-00,RATING;CCTV,TETRON PAPER,T0.05,	1	SNA	
0.1		BN91-05540R	ASSY SHIELD;LC6200	1	SNA	
..2	T0081	6001-002284	SCREW-MACHINE;BH,+,M4,L8,ZPC(WHT),SWRCH1	8	SA	
..2	T0081	6001-002604	SCREW-MACHINE;BH,+,M4,L10,ZPC(WHT),SWRCH	2	SA	
..2	M0081	6003-000337	SCREW-TAPTYPE;BH,+,S,M4,L10,ZPC(BLK),SWR	6	SA	
..2	M0081	6003-001003	SCREW-TAPTYPE;BH,+,B,M4,L12,ZPC(BLK),SWR	7	SA	
..2	M2893	BN39-01274A	LEAD CONNECTOR;LC5F,UL 1007 #26,14P,80mm	1	SA	
..2	T0764	BN44-00339A	SMPS-LCD TV;P3237F1_ASM,P3237F1_ASM,AC/D	1	SA	
..2		BN61-06441A	HOLDER-INLET;LC530,ABS,V0	1	SNA	
..2	CCMM1	BN73-00264A	SILICON/RUBBER;LE32C530F1WXXC,SILICON+PO	1	SNA	
..2	M0523	BN96-12973A	ASSY BRACKET P-WALL;32,37,40,LC650,SECC,	4	SNA	
...3	T0101	BN61-05996A	BRACKET-WALL;LC650 40,SECC,T1.2	4	SNA	
...3		BN60-00188B	SPACER-FOAM;LCD,FELT,20,3.0,20,Center :	4	SNA	
..2	FL06	BN96-13171N	ASSY CABLE P-FFC;LE32C530F1WXXC,FFC,0.5m	1	SA	
..2	T0910	BN96-13341A	ASSY BRACKET P-STAND LINK;LC530 32,SECC,	1	SNA	
...3		BN61-02429K	STUD-PEM;PNB,M3.8,D7,L14.9,ZPC(SIL),SUM2	4	SNA	
...3	M0115	BN61-06024A	BRACKET-STAND LINK;LC550 32",SECC,T1.2	1	SNA	
...3		BN61-05281A	HOLDER-CLAMP;LCD,NYLON 66,WHT	2	SNA	

5. Exploded View & Part List

5-1. LA40C550J1F Exploded View

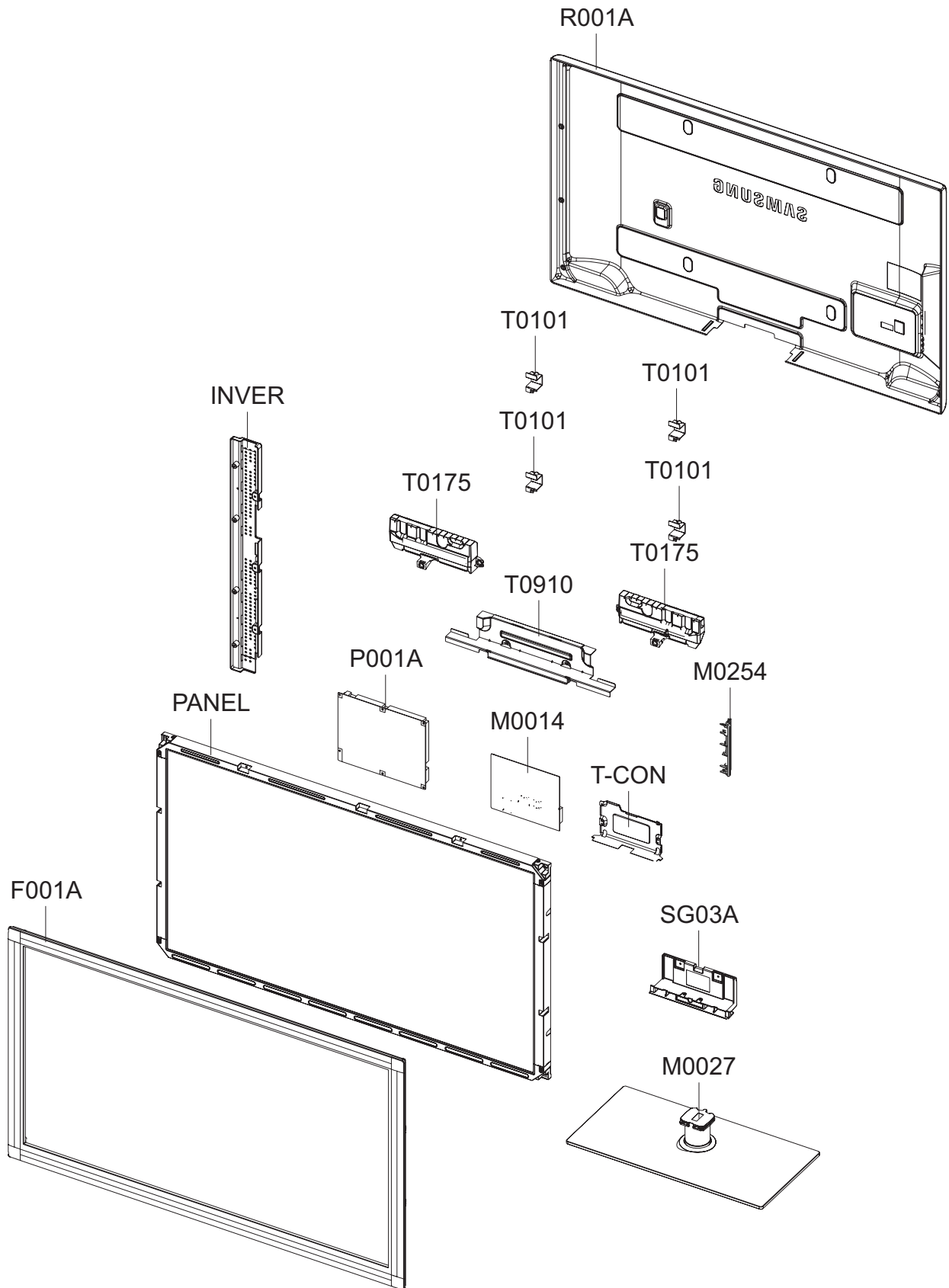

5-2. LA40C550J1F Parts List

Location No.	Code No.	Description & Specification	Q'ty	SA/SNA	Remark
F001A	BN96-12808E	ASSY COVER P-FRONT;40,LC550,CHINA(DTV),P	1	SA	
PANEL	BN07-00800A	LCD-PANEL;LTF400HM01,SSDZMS,8bit,40,1.67	1	SA	
TCON	BN81-04153A	A/S-T CON LTF400HM01;LTF400HM01	1	SA	
INVER	BN81-04169A	A/S-BB-L LTF400HM01;LTF400HM01	1	SA	
P001A	BN44-00340B	IP BOARD-TV;I40F1_ADY,I40F1_ADY,14mA,16m	1	SA	
M0014	BN94-03739A	ASSY PCB MAIN;LA37C550J1F,N82A,DTV	1	SNA	
M0254	BN61-06066B	HOLDER-SIDE AV;LC550,PMMA+ABS,HB,BK0007	1	SNA	
T0910	BN96-13342A	ASSY BRACKET P-STAND LINK;LC530 37/40/46	1	SNA	
T0175	BN96-12837A	ASSY SPEAKER P;6ohm,4pin,10W,L:570 R:250	1	SA	
T0101	BN61-05996A	BRACKET-WALL;LC650 40,SECC,T1.2	4	SNA	
R001A	BN96-12767S	ASSY COVER P-REAR;40,LC550,XZ(DTV),PCM,T	1	SA	
SG03A	BN96-12795D	ASSY STAND P-GUIDE;37,40,46,LC650,W/W,PC	1	SA	
M0027	BN96-12762A	ASSY STAND P-BASE;37,40,EXPORT,TEMPERED	1	SA	

5-2-1. LA40C550J1F Parts List

Service Bom (SA: SERVICE AVAILABLE, SNA: SERVICE NOT AVAILABLE)

Level	Location No.	Code No.	Description & Specification	Q'ty	SA/SNA	Remark
			LA40C550J1FXXZ			
0.1	S001A	BN90-02443B	ASSY STAND;37,40,LC650,W/W,2COAT,ROSE BL	1	SNA	
..2	M0027	BN96-12762A	ASSY STAND P-BASE;37,40,EXPORT,TEMPERED	1	SA	
...3	M0081	6003-001003	SCREW-TAPTYPE;BH,+ ,B,M4,L12,ZPC(BLK),SWR	6	SA	
...3		BN61-04692A	BOSS-PRIMER;#94,clear,35cps	0.1	SNA	
...3		BN61-04731D	BOSS-TAPE;AMBER,ACRYL,T1.1,W20.0mm,WHITE	0.29	SNA	
...3		BN61-05244A	BRACKET-SWIVEL BOTTOM;LB700 46,HGI,T3.0	1	SNA	
...3		BN61-05493A	HOLDER-SWIVEL RING BOTTOM;LB650 40,Aceta	1	SNA	
...3		BN61-05826A	BOSS-BOND;#760,Poly urethane,Black	2.6	SNA	
...3	GSN01	BN61-05994A	GUIDE-STAND NECK;40,LC650,PETG,V2,TP0003	1	SNA	
...4		BN61-06079B	GUIDE-NECK-INSERT;LC650 40,PETG HB,TP000	1	SNA	
...3	CCM1	BN63-04755A	COVER-SHEET;AMBER,PE,T0.05,W150mm,200M,6	1.14	SNA	
...3		BN63-05781D	COVER-STAND GLASS;40,LC650,GLASS,T8.0,2C	1	SNA	
...3	T0527	BN68-01648B	LABEL WARNING;WW,PET,T0.05,40,25,EXPORT	1	SNA	
...3	M0126	BN73-00215A	RUBBER-FOOT;40LB650,RUBBER,15*25,60,4.0,	4	SNA	
...3	M0126	BN73-00217A	RUBBER-FOOT;LB650,RUBBER,DIA30,7.5,Dark	4	SNA	
...3		BN74-00031A	GREASE;kanto-kasei FL-955,grease,wht	0.4	SNA	
...3	FD01	BN63-06913A	COVER-DECORATION;LB7000 46,ABS+PMMA,HB,H	1	SNA	
...3		BN61-05652C	BRACKET-STAND BOTTOM;B650 40,SGCC,T2.0,V	1	SNA	
..2	SG03A	BN96-12795D	ASSY STAND P-GUIDE;37,40,46,LC650,W/W,PC	1	SA	
...3	T0920	BN61-06003A	GUIDE-STAND;37,40,46,LC650,PC+G/F,20%,V2	1	SNA	
...3		BN68-02766B	MANUAL FLYER-STAND GUIDE;L550~L750,SAMSU	1	SNA	
...3		BN96-12031G	ASSY ACCESSORY-SCREW;10 LCD-TV,6003-0010	1	SNA	
...4	M0081	6003-001003	SCREW-TAPTYPE;BH,+ ,B,M4,L12,ZPC(BLK),SWR	9	SA	
...4	T0524	6902-000341	BAG PE;LDPE,T0.05,L90,W70,TRP,,,PE MARK	1	SNA	
...3	T0524	6902-001063	BAG PE;LDPE,T0.05,W180,L350,TRP,RECYCLE	1	SNA	
0.1	R001A	BN90-02448S	ASSY COVER REAR;LA40C550J1FXXZ	1	SNA	
..2	M0081	6003-001003	SCREW-TAPTYPE;BH,+ ,B,M4,L12,ZPC(BLK),SWR	11	SA	
..2	R001A	BN96-12767S	ASSY COVER P-REAR;40,LC550,XZ(DTV),PCM,T	1	SA	
...3	R001	BN63-06393D	COVER-REAR;40,LC550,SO,PCM,T0.5,BLK	1	SNA	
...3		BN64-01270Q	INLAY-AV;LC550,CO,PS SHEET,T0.5	1	SNA	
...3	T0071	BN64-01297F	INLAY-TERMINAL;LC550,XZ(DTV),PS SHEET,T0	1	SNA	
...3	T0139	BN65-00003A	CLAMPER BAG;42C7,LDPE,HB,BLK	1	SNA	
...3	AH358	BN61-06545A	HOLDER-REAR;LC650 37/40/46,PP,BLK	1	SNA	
...3	M0131	BN63-03845A	GASKET;EMT4-10-4-110R-DM8,4T,10MM,100MM	3	SNA	
...3		BN60-00162X	SPACER-FOAM;FOAM,30000mm,Dark Gray,1T,15	1.65	SNA	
0.1		BN90-02474E	ASSY COVER FRONT;LA40C550J1FXXZ	1	SNA	
..2	F001A	BN96-12808E	ASSY COVER P-FRONT;40,LC550,CHINA(DTV),P	1	SA	
...3	AB326	BN61-04661A	BRACKET-STOPPER;L650,SK-5,T0.4,Plating,H	5	SNA	
...3	CCM1	BN63-02183G	COVER-SHEET;Rhcm,PE Vinyl,T0.05,1100mm,2	0.76	SNA	
...3	F001	BN63-06386E	COVER-FRONT;40,LC550,CHINA(DTV),PMMA+PMM	1	SNA	
...3		BN96-12777B	ASSY HOLDER P-BOSS BOTTOM;40,LC630,ABS,H	1	SNA	
...4		BN61-04731A	BOSS-TAPE;AMBER,ACRYL,T1.1,W8.0mm,WHITE	0.43	SNA	
...4		BN61-06075B	HOLDER-BOSS BOTTOM;40,LC630,ABS,HB,WT003	1	SNA	
...3		BN63-05940H	COVER-SHEET;PE,T0.08,620mm,200M,CLEAR,40	2	SNA	
...3		BN60-00163C	SPACER-FOAM;LC650-40",FOAM,500,0.5,25,Bo	2	SNA	
...3		BN60-00163H	SPACER-FOAM;LC650-40",FOAM,890,T 0.5,20,	1	SNA	

5. Exploded View & Part List

Level	Location No.	Code No.	Description & Specification	Q'ty	SA/SNA	Remark
...3	M0125	BN96-13451B	ASSY BOARD P-TOUCH FUNCTION&IR;LN32C550J	1	SA	
...3		BN74-00052A	TAPE-PAPER;LB530,Crepe Paper,0.17mm, 10m	0.05	SNA	
..2	T0175	BN96-12837A	ASSY SPEAKER P;6ohm,4pin,10W,L:570 R:250	1	SA	
0.1		BN91-04889A	ASSY LCD-AMLCD;BN07-00800A	1	SNA	
..2	PANEL	BN07-00800A	LCD-PANEL;LTF400HM01,SSDZMS,8bit,40,1.67	1	SA	
...3	TCON	BN81-04153A	A/S-T CON LTF400HM01;LTF400HM01	1	SA	
...3	INVER	BN81-04169A	A/S-BB-L LTF400HM01;LTF400HM01	1	SA	
0.1		BN92-05856A	ASSY P/MATERIAL;40,LC650	1	SNA	
..2	T0214	0203-001595	TAPE-OPP MASKING;OPP-2,0.075,75,800M,CLR	2.7	SNA	
..2		6902-000061	BAG AIR;LDPE,T0.2,W500,L1000,TRP,370.000	1	SNA	
..2		6902-000379	BAG AIR;LDPE,T0.2,W1000,L1800,TRP,1260.0	1	SNA	
..2		6902-000604	BAG WRAPPING;LDPE,T0.02,W500,L10000,TRP,	4.41	SNA	
..2		6902-000609	BAG ROLL;LDPE,T0.05,W2400,L1000,TRP,30.0	0.03	SNA	
..2	T0524	6902-001043	BAG PE;HDPE/NITRON,T0.015/T0.5,W1200,L80	1	SNA	
..2		BN69-00391P	PAD-ANGLE;OTHER,T4,50,2200,YEL	1	SNA	
..2	T0246	BN69-04325A	CUSHION-01,SET;LC650 40,EPS	1	SNA	
..2		BN68-02422B	LABEL-WARNING SHIPPING;ALL MODEL,A/P 100	1	SNA	
..2		6902-001178	BAG SHEET;HDPE/NITRON,T0.015/T01.0,W400,	1	SNA	
..2	M040	6922-000013	BAND PP;PP,W18,L2300m,TRP,21000g	1.3	SNA	
0.1		BN92-05899E	ASSY BOX;LA40C550J1FXXZ	1	SNA	
..2		BN69-04632G	BOX-SET;40LC550,CB,A-01,DW3,YEL,W1195,D1	1	SNA	
..2		BH68-00662A	LABEL BOX-00;ALL MODEL,MOJO 90G,60,110,W	1	SNA	
0.1	ACCE1	BN92-05942A	ASSY ACCESSORY;LA40C550J1FXXZ,N82A,LC550	1	SNA	
..2		BN96-13621A	ASSY ACCESSORY-MANUAL;LA32C550J1FXXZ,LC5	1	SNA	
...3	T0524	6902-000110	BAG PE;LDPE,T0.05,W250,L400,TRP,28,2,9.2	1	SNA	
...3	T0527	AA68-00764A	LABEL-PASSING;SAMSUNG ALL,ART PAPER,CLR,	1	SNA	
...3	T0527	AA68-02517A	LABEL;PJTV(TTSEC),COPPERPLATE,50,75,YELL	1	SNA	
...3	T0059	AA68-03184A	MANUAL FLYER-CARD-07;ALL MODEL,CHINESE,2	1	SNA	
...3	T0527	BN68-00513A	LABEL-E,PASS;ALL MODEL,YUPO(110G),50X15,	1	SNA	
...3		BN68-02186A	MANUAL FLYER-TOC GUIDE;COMM,SAMSUNG,11 L	1	SNA	
...3		BN68-02515A	MANUAL USERS;LC550&530&480&360,SAMSUNG,S	1	SNA	
..2	ACCE2	BN96-13652A	ASSY ACCESSORY-CABLE;LA40C550J1FXXZ,LC55	1	SNA	
...3	T0268	3903-000434	CBF-POWER CORD;DT,CN,IP3/YES,IEC320 C13-	1	SA	
...3	T0524	6902-001107	BAG PE;LDPE,T0.05,W450,L400,TRP,0,3Separ	1	SNA	
...3	M9889	BN63-01798B	CLOTH-CLEAN;cloth,180,200,sea blue,ToC	1	SA	
...3	T0531	BN63-06339A	COVER-BOTTOM;37,40,46,LC650,HIPS,HB,BK00	1	SA	
...3	T0527	BN68-00513A	LABEL-E,PASS;ALL MODEL,YUPO(110G),50X15,	1	SNA	
...3		BN43-00004A	BATTERY;BM1L,BATTERY,MN,600mAh,7.9g	2	SNA	
...3	REMO2	BN59-01017A	REMOCON;TM1050,SAMSUNG,20PIN SINGLE,48KE	1	SA	
...3		BN61-05596A	HOLDER-WIRE CABLE;LED TV,LDPE,T0.8,L150,	1	SNA	
...3	M0254	AA59-00416A	ANT SHIELD BOX;UGC-AS-001A,PAL-BG,DK,I,M	1	SA	
0.1		BN92-05951A	ASSY LABEL;LA40C550J1FXXZ,LC550,N82A	1	SNA	
..2	T0527	BP68-00052B	LABEL-00,RATING;CCTV,TETRON PAPER,T0.05,	1	SNA	
0.1		BN91-05276W	ASSY SHIELD;LA40C550J1MXZK	1	SNA	
..2	T0081	6001-002284	SCREW-MACHINE;BH,+,M4,L8,ZPC(WHT),SWRCH1	10	SA	
..2	T0081	6001-002604	SCREW-MACHINE;BH,+,M4,L10,ZPC(WHT),SWRCH	2	SA	
..2	M0081	6003-000337	SCREW-TAPTYPE;BH,+,S,M4,L10,ZPC(BLK),SWR	6	SA	
..2	M0081	6003-001003	SCREW-TAPTYPE;BH,+,B,M4,L12,ZPC(BLK),SWR	6	SA	
..2	M2893	BN39-01024E	LEAD CONNECTOR;LC5F,UL3239#24,2P,175mm,1	1	SA	
..2	M2893	BN39-01279E	LEAD CONNECTOR;LB6T,Flat Connector Ass'y	1	SA	
..2	P001A	BN44-00340B	IP BOARD-TV;I40F1_ADY,I40F1_ADY,14mA,16m	1	SA	

5. Exploded View & Part List

Level	Location No.	Code No.	Description & Specification	Q'ty	SA/SNA	Remark
.2		BN61-06441A	HOLDER-INLET;LC530,ABS,V0	1	SNA	
.2	CCMM1	BN73-00264A	SILICON/RUBBER;LE32C530F1WXXC,SILICON+PO	1	SNA	
.2	M0523	BN96-12973A	ASSY BRACKET P-WALL;32,37,40,LC650,SECC,	4	SNA	
...3	T0101	BN61-05996A	BRACKET-WALL;LC650 40,SECC,T1.2	4	SNA	
...3		BN60-00188B	SPACER-FOAM;LCD,FELT,20,3.0,20,Center :	4	SNA	
.2	M0230	BN96-13171C	ASSY CABLE P-FFC;LN40C530F1FXZA,FFC,0.5m	1	SA	
.2	T0910	BN96-13342A	ASSY BRACKET P-STAND LINK;LC530 37/40/46	1	SNA	
...3		BN61-02429K	STUD-PEM;PNB,M3.8,D7,L14.9,ZPC(SIL),SUM2	2	SNA	
...3	M0115	BN61-05998A	BRACKET-STAND LINK;LC650 46,SECC,T1.6	1	SNA	
...3		BN61-05281A	HOLDER-CLAMP;LCD,NYLON 66,WHT	3	SNA	
0.1	M0017	BN91-05821A	ASSY CHASSIS;LA37C550J1F,N82A,DTV	1	SNA	
.2	M0014	BN94-03739A	ASSY PCB MAIN;LA37C550J1F,N82A,DTV	1	SNA	
...3		0202-001608	SOLDER-WIRE FLUX;LFC7-107,D0.8,99.3Sn/0.	0.25	SNA	
...3		3701-001480	CONNECTOR-DSUB;15P,3R,FEMALE,STAMPED PIN	1	SA	
...3	CN906	3707-001096	CONNECTOR-OPTICAL;STRAIGHT W/L,SPDIF	1	SA	
...3		3711-007302	HEADER-BOARD TO BOARD;BOX,18P,2R,2mm,ANG	1	SA	
...3		3722-003037	JACK-USB;4P/1C W/L,AU/NI,BLK,ANGLE,A	1	SA	
...3	JA330	3722-003038	JACK-PHONE;7P/1C W/L,SN,BLK	2	SA	
...3	JA333	3722-003040	JACK-PIN;3P W/L,SN,BLK/YEL/WHT/RED,ANGLE	1	SA	
...3	JA333	3722-003052	JACK-PIN;5P+Shield W/L,NI/SN,GN/BL/RD/WH	2	SA	
...3		3722-003058	JACK-MODULAR;8P/8C W/L,Y,STRAIGHT,N,AU,1	1	SA	
...3		3722-003088	JACK-USB;4P/1C,NI/PD/AU/SN,GRY,STRAIGHT,	1	SA	
...3	M2893	BN39-01267E	LEAD CONNECTOR;LB6T,FLAT CONNECTOR ASS'Y	1	SA	
...3	ET01	BN40-00183A	TUNER;DNCS443VL161A(S),DTMB/PAL/NTSC,75o	1	SA	
...3	M0254	BN61-06066B	HOLDER-SIDE AV;LC550,PMMA+ABS,HB,BK0007	1	SNA	
...3	T0066	BN62-00040A	HEAT SINK-ES;SAPPHIRE,T2.0,36*36*6.6,BLK	1	SNA	
...3	M0412	BN96-11826C	ASSY BRACKET P-PCB;LB450 40,SPTE T0.5 +	1	SNA	
...4		BN61-04928C	BRACKET-SUPPORT PCB;SPTE,T 0.5,SCREW-M4	1	SNA	
...4		BN61-05262B	HOLDER-BOSS PCB;52,LB550(EO),PBT+G/F(30%	1	SNA	
...3		BN97-04052A	ASSY SMD-MAIN;SX1 550,DTV	1	SNA	
...4	DS01A	0401-001056	DIODE-SWITCHING;MMBD4148SE,100V,200mA,SO	16	SA	
...4		0403-001164	DIODE-ZENER;MMSZ5232B,5.32-5.88V,500MW,S	1	SA	
...4		0403-001783	DIODE-ZENER;BZB84-C6V2,5.8/6.6V,300mW,SO	15	SNA	
...4	D0254	0404-001271	DIODE-SCHOTTKY;SSA34,40V,3000mA,SMA,TP	1	SA	
...4	D0254	0404-001404	DIODE-SCHOTTKY;BAT721C,40V,200mA,SOT-23,	1	SA	
...4	T0139	0406-001200	DIODE-TVS;RCLAMP0504F,6/-V,150W,SC-70	2	SA	
...4	T0139	0406-001271	DIODE-TVS;RCLAMP0524P,6/-V,150W,SLP251	9	SNA	
...4	SD3	0407-000114	DIODE-SWITCHING;KDS184,80V,100mA,SOT-23,	3	SNA	
...4	Q101	0501-000445	TR-SMALL SIGNAL;KTC3875S-Y,NPN,150mW,SOT	8	SA	
...4	CEQ2	0505-000110	FET-SILICON;2N7002,N,60V,115mA,7.5ohm,0.	8	SA	
...4	Q409	0505-000274	FET-SILICON;AO4435L,P,-30V,-11A,0.014ohm	1	SNA	
...4	T0596	0904-002554	IC-USC;AU6256-JBF,QFN,28P,5x5mm,12MHz,TP	1	SA	
...4	IC106	1001-001573	IC-VIDEO SWITCH;Sii9287BCNUTR,QFN,72P,10	1	SNA	
...4		1006-001266	IC-LINE TRANSCEIVER;3232,TSSOP,16P,174MI	1	SA	
...4		1006-001474	IC-LINE DRIVER;DRV604PWP,HPSSOP,28P,9.8x	1	SA	
...4	IC112	1103-000129	IC-EEPROM;24C02,2Kbit,256x8,SOP,8P,5x4mm	2	SA	
...4	IC112	1103-001385	IC-EEPROM;AT24C256,256Kbit,32Kx8,SOP,8P,	1	SA	
...4		1105-002058	IC-DDR2 SDRAM;K4T1G164QE-HCF8,DDR2,1Gbit	2	SA	
...4	T0124	1201-002992	IC-POWER AMP;STA369BWS,PSSO,36P,10.3x7.5	1	SA	
...4	T0087	1203-001815	IC-POSI.FIXED REG.;78M09,TO-252,3P,PLAST	1	SA	
...4	T0087	1203-002835	IC-POSI.FIXED REG.;KIA7805AF,DPAK,3P,6.6	1	SA	

5. Exploded View & Part List

Level	Location No.	Code No.	Description & Specification	Q'ty	SA/SNA	Remark
....4	T0087	1203-002898	IC-POSI.FIXED REG.;G950T45R,T0-252,3P,6.	1	SA	
....4		1203-004364	IC-VOL. DETECTOR;RT9818C-42PV,SOT-23,3P,	1	SA	
....4	T0087	1203-005134	IC-POSI.FIXED REG.;RT9167A-33PB,SOT-23-5	1	SNA	
....4		1203-005559	IC-BACKLIGHT DRIVER;MP3302DJ,TSOT23,5P,2	1	SA	
....4		1203-006013	IC-DC/DC CONVERTER;AOZ1031AI,SO-8,8P,4.9	2	SA	
....4		1203-006017	IC-VOL. DETECTOR;RT9824GJ8,TSOT23,8P,2.9	1	SA	
....4	T0087	1203-006135	IC-POSI.FIXED REG.;AP1117D-33-GZ-13-89,T	1	SA	
....4	T0087	1203-006136	IC-POSI.FIXED REG.;AP1117D-18-GZ-13-89,T	1	SA	
....4		1204-003096	IC-VIDEO DECODER;HIDTVPRO-SX,PBGA,580P,P	1	SA	
....4		1204-003117	IC-AUDIO PROCESSOR;MSP3455G,PMQFP,44P,13	1	SA	
....4		1205-003201	IC-BUS SWITCH;TC7WB125FK,SSOP,8P,2x2.3mm	2	SA	
....4		1205-003733	IC-SWITCH;AP2191MPG-13,MSOP-8L-EP,8P,2.9	1	SA	
....4		1205-003735	IC-SWITCH;AP2151WG-7,SOT25,5P,2.9x1.6mm,	1	SA	
....4		1405-001185	VARISTOR;24Vdc,1.6x0.8x0.36mm,TP	1	SA	
....4		1405-001271	VARISTOR;20Vdc,5A,1.0x0.5x0.6mm,TP	25	SA	
....4	R105	2007-000138	R-CHIP;100ohm,5%,1/16W,TP,1005	33	SNA	
....4	AR49	2007-000140	R-CHIP;1Kohm,5%,1/16W,TP,1005	5	SNA	
....4	MR306	2007-000141	R-CHIP;2.2Kohm,5%,1/16W,TP,1005	11	SNA	
....4	R319	2007-000143	R-CHIP;4.7Kohm,5%,1/16W,TP,1005	53	SNA	
....4	R104	2007-000148	R-CHIP;10Kohm,5%,1/16W,TP,1005	38	SNA	
....4	R102	2007-000149	R-CHIP;12Kohm,5%,1/16W,TP,1005	8	SA	
....4	HDR9	2007-000152	R-CHIP;20Kohm,5%,1/16W,TP,1005	2	SNA	
....4	MR36	2007-000153	R-CHIP;22Kohm,5%,1/16W,TP,1005	5	SNA	
....4	AR43	2007-000155	R-CHIP;27Kohm,5%,1/16W,TP,1005	2	SNA	
....4	MR13	2007-000157	R-CHIP;47Kohm,5%,1/16W,TP,1005	7	SNA	
....4	R123	2007-000159	R-CHIP;56Kohm,5%,1/16W,TP,1005	1	SNA	
....4	DR39	2007-000162	R-CHIP;100Kohm,5%,1/16W,TP,1005	2	SNA	
....4	R509	2007-000170	R-CHIP;1Mohm,5%,1/16W,TP,1005	1	SNA	
....4	R111	2007-000171	R-CHIP;0ohm,5%,1/16W,TP,1005	11	SNA	
....4	HDR17	2007-000172	R-CHIP;10ohm,5%,1/16W,TP,1005	4	SNA	
....4	R338	2007-000173	R-CHIP;22ohm,5%,1/16W,TP,1005	12	SNA	
....4	MR9	2007-000455	R-CHIP;18Kohm,1%,1/10W,TP,1608	1	SA	
....4	ER13	2007-000669	R-CHIP;2Kohm,1%,1/10W,TP,1608	1	SNA	
....4	R726	2007-000695	R-CHIP;3.3ohm,5%,1/10W,TP,1608	1	SNA	
....4		2007-000755	R-CHIP;330Kohm,1%,1/10W,TP,1608	1	SA	
....4	R124	2007-000775	R-CHIP;33Kohm,5%,1/16W,TP,1005	3	SNA	
....4		2007-001285	R-CHIP;5.6ohm,5%,1/16W,TP,1005	4	SA	
....4	OTR1	2007-001292	R-CHIP;33ohm,5%,1/16W,TP,1005	4	SNA	
....4	R326	2007-001325	R-CHIP;3.3Kohm,5%,1/16W,TP,1005	11	SNA	
....4	TR30	2007-007009	R-CHIP;75ohm,5%,1/16W,TP,1005	11	SNA	
....4		2007-007134	R-CHIP;39Kohm,1%,1/16W,TP,1005	1	SA	
....4	DR4	2007-007142	R-CHIP;10Kohm,1%,1/16W,TP,1005	4	SNA	
....4		2007-007156	R-CHIP;1ohm,5%,1/16W,TP,1005	6	SNA	
....4		2007-007316	R-CHIP;3.3Kohm,1%,1/16W,TP,1005	1	SNA	
....4		2007-007318	R-CHIP;1Kohm,1%,1/16W,TP,1005	9	SNA	
....4		2007-007334	R-CHIP;200Kohm,1%,1/16W,TP,1005	4	SNA	
....4		2007-007698	R-CHIP;5.1Kohm,1%,1/16W,TP,1005	1	SNA	
....4	MR11	2007-008015	R-CHIP;75ohm,1%,1/16W,TP,1005	9	SNA	
....4		2007-008134	R-CHIP;12.4Kohm,1%,1/16W,TP,1005	2	SC	
....4		2007-008298	R-CHIP;49.9ohm,1%,1/16W,TP,1005	4	SA	
....4		2007-008593	R-CHIP;750ohm,1%,1/16W,TP,1005	1	SA	

5. Exploded View & Part List

Level	Location No.	Code No.	Description & Specification	Q'ty	SA/SNA	Remark
...4	DAR09	2011-001262	R-NETWORK;22ohm,5%,1/16W,L,CHIP,8P,TP,2.	6	SA	
...4	DRP29	2011-001396	R-NETWORK;4.7Kohm,5%,1/16W,L,CHIP,8P,TP,	1	SA	
...4		2011-001448	R-NETWORK;10ohm,5%,1/16W,L,4P,T,1010	4	SA	
...4		2011-001449	R-NETWORK;22ohm,5%,1/16W,L,4P,TP,1010	5	SA	
...4		2011-001519	R-NETWORK;33OHM,5%,1/16W,L,CHIP,4P,TP,1.	3	SA	
...4		2011-001527	R-NETWORK;4.7Kohm,5%,1/16W,L,CHIP,4P,TP,	8	SNA	
...4		2011-001587	R-NETWORK;100ohm,5%,1/16W,L,CHIP-V,4P,TP	1	SNA	
...4		2011-001589	R-NETWORK;0ohm,5%,1/16W,L,CHIP-V,4P,TP,1	16	SNA	
...4	C4N08	2203-000140	C-CER,CHIP;1.5nF,10%,50V,X7R,1608	3	SNA	
...4	PC43	2203-000233	C-CER,CHIP;0.1nF,5%,50V,C0G,TP,1005	1	SA	
...4	MC302	2203-000425	C-CER,CHIP;.018nF,5%,50V,C0G,TP,1005	2	SA	
...4	C254	2203-000438	C-CER,CHIP;1nF,10%,50V,X7R,TP,1005	13	SA	
...4	AC139	2203-000491	C-CER,CHIP;2.2nF,10%,50V,X7R,1608	2	SA	
...4	V1233	2203-000575	C-CER,CHIP;220nF,10%,25V,X7R,TP,2012	6	SNA	
...4	MC9	2203-000627	C-CER,CHIP;.022nF,5%,50V,C0G,TP,1005	3	SNA	
...4	DC25	2203-000812	C-CER,CHIP;.033nF,5%,50V,C0G,1005	9	SA	
...4	CK40B	2203-000838	C-CER,CHIP;0.39NF,5%,50V,C0G,TP,1608	3	SNA	
...4	AD480	2203-000995	C-CER,CHIP;.047nF,5%,50V,C0G,TP,1005	2	SA	
...4	HDC5	2203-001072	C-CER,CHIP;0.056nF,5%,50V,NP0,1005	4	SA	
...4	C101	2203-001124	C-CER,CHIP;0.68NF,10%,50V,X7R,TP,1005	1	SA	
...4	AD480	2203-001412	C-CER,CHIP;0.03nF,5%,50V,NP0,TP,1005	10	SNA	
...4	AD480	2203-001428	C-CER,CHIP;470nF,10%,50V,X7R,TP,2012	2	SNA	
...4	C637	2203-001656	C-CER,CHIP;0.47nF,5%,50V,NP0,1608	3	SNA	
...4	AD480	2203-002285	C-CER,CHIP;10nF,10%,50V,X7R,1005	14	SNA	
...4	AD480	2203-002525	C-CER,CHIP;0.56nF,10%,50V,X7R,TP,1005	8	SNA	
...4	AD480	2203-005052	C-CER,CHIP;0.0033nF,0.25pF,50V,NP0,1005	2	SA	
...4	AC611	2203-005194	C-CER,CHIP;.22nF,10%,50V,X7R,TP,1608	1	SA	
...4	AAC1	2203-005249	C-CER,CHIP;100nF,10%,50V,X7R,TP,1608	11	SNA	
...4	AD480	2203-005968	C-CER,CHIP;4.7NF,10%,50V,X7R,TP,1005	2	SNA	
...4	AD480	2203-006104	C-CER,CHIP;1000nF,10%,50V,X7R,3225	1	SA	
...4	PC11	2203-006141	C-CER,CHIP;1000nF,10%,16V,X5R,1608	1	SNA	
...4	C102	2203-006158	C-CER,CHIP;100nF,10%,16V,X7R,1005	115	SNA	
...4	JC10	2203-006324	C-CER,CHIP;2200nF,10%,10V,X5R,1608	2	SA	
...4	AD480	2203-006336	C-CER,CHIP;10000nF,10%,25V,X5R,3216	20	SA	
...4	C125	2203-006361	C-CER,CHIP;10000nF,10%,10V,X5R,TP,2012	48	SC	
...4	HDC11	2203-006562	C-CER,CHIP;1000nF,10%,10V,X5R,TP,1005	14	SNA	
...4	AD480	2203-006824	C-CER,CHIP;4700nF,10%,10V,X5R,1608	1	SNA	
...4	AD480	2203-006841	C-CER,CHIP;1000nF,10%,16V,X5R,1005	15	SNA	
...4	AD480	2203-006992	C-CER,CHIP;0.33nF,5%,50V,C0G,TP,1005	2	SNA	
...4	AD480	2203-007270	C-CER,CHIP;10000nF,10%,10V,X5R,TP,1608	3	SNA	
...4	T0052	2703-000158	INDUCTOR-SMD;1uH,10%,2012	9	SA	
...4	VL6	2703-000398	INDUCTOR-SMD;10uH,10%,3225	5	SA	
...4	T0052	2703-001239	INDUCTOR-SMD;3.3uH,10%,1608	1	SA	
...4	T0052	2703-001778	INDUCTOR-SMD;3.3uH,20%,3225	2	SA	
...4	T0052	2703-003149	INDUCTOR-SMD;2.2uH,20%,5050	3	SA	
...4	T0052	2703-003150	INDUCTOR-SMD;4.7uH,20%,5050	4	SNA	
...4	X202	2801-003326	CRYSTAL-SMD;24MHz,30ppm,28-ABX,20pF,50oh	1	SA	
...4	X202	2801-004300	CRYSTAL-SMD;18.432MHz,30ppm,28-ABX,13pF,	1	SA	
...4	X202	2801-004775	CRYSTAL-SMD;12MHz,30ppm,16pF,30ohm,TP	1	SNA	
...4	F103	2901-001506	FILTER-EMI SMD;5V,0.13A,0pF,2x1x0.5mm,TP	2	SA	
...4	T0568	3301-001236	BEAD-SMD;60ohm,1608	7	SNA	

5. Exploded View & Part List

Level	Location No.	Code No.	Description & Specification	Q'ty	SA/SNA	Remark
....4	T0568	3301-002039	BEAD-SMD;26ohm,1608,TP	37	SA	
....4	T0313	3404-001207	SWITCH-TACT;12V,50mA,160gf,6.2X6.2,SPST	1	SA	
....4		3601-001374	FUSE-SURFACE MOUNT;32V,5A,FAST-ACTING,Hi	1	SNA	
....4		3701-001591	CONNECTOR-HDMI;19P,2ROW,FEMALE,SMD-S,AU	3	SNA	
....4	AC510	3708-002797	CONNECTOR-FPC/FFC/PIC;51P,0.50mm,SMD,AU,	1	SA	
....4		3710-002111	SOCKET-BOARD TO BOARD;60P,2R,0.5MM,SMD-S	1	SA	
....4	CON_US	3711-005616	HEADER-BOARD TO CABLE;BOX,10P,1R,2mm,SMD	1	SNA	
....4	HB01A	3711-007336	HEADER-BOARD TO CABLE;BOX,4P,1R,2.5mm,SM	1	SA	
....4		BN41-01407A	PCB MAIN;SA1,FR-4,4L,1.0,1.2T,192*195,SA	1	SNA	
....4	D0254	0402-000553	DIODE-SCHOTTKY;SS24/B240,40V,2000mA,DO-2	2	SA	
....4		2011-001427	R-NETWORK;0ohm,5%,1/16W,L,CHIP,8P,TP,2.0	1	SNA	
....4	L1103	2703-000403	INDUCTOR-SMD;22uH,10%,3225	1	SA	
....4		1203-005538	IC-DC/DC CONVERTER;AOZ1021HAIL,SOP,8P,4.	1	SA	
....4		1203-006288	IC-VOL. DETECTOR;RT9818B-18GV,SOT-23-3,3	1	SA	
....4	PR6	2007-000072	R-CHIP;47ohm,5%,1/10W,TP,1608	4	SNA	
....4	HDR7	2007-000139	R-CHIP;220ohm,5%,1/16W,TP,1005	3	SNA	
....4		2007-007135	R-CHIP;18Kohm,1%,1/16W,TP,1005	1	SNA	
....4	C711	2203-002982	C-CER,CHIP;6.8nF,10%,50V,X7R,1005	1	SA	
....4	HE4	2203-006474	C-CER,CHIP;2200nF,20%,6.3V,X5R,2012	2	SA	
....4		BN97-04281A	ASSY MICOM;T-TDT5DEUS-1002,N82A,MX25L400	1	SNA	
....5	IC115	1107-001580	IC-FLASH MEMORY;MX25L4005,4Mbit,512Kx8,S	1	SNA	
....4		BN97-04282A	ASSY MICOM;T-TDT5DCNC-1002.0,N82A,KFG1G1	1	SNA	
....5		1107-001818	IC-NAND FLASH;KFG1G16U2C-DIB6,1024Mbit,6	1	SNA	
....4		0202-001767	SOLDER-CREAM;LST-5710,D20~38,Sn-57Bi-1Ag	0.409	SNA	
....4	HR3	2007-000903	R-CHIP;430ohm,1%,1/10W,TP,1608	1	SNA	
....4		2007-001317	R-CHIP;910ohm,5%,1/16W,TP,1005	1	SNA	
....4		2007-002768	R-CHIP;6.2Kohm,1%,1/10W,TP,1608	1	SA	
....4		2007-007317	R-CHIP;2.2Kohm,1%,1/16W,TP,1005	1	SA	
....4		2007-008275	R-CHIP;30Kohm,1%,1/16W,TP,1005	1	SNA	
....4	DC87	2203-001153	C-CER,CHIP;.068nF,5%,50V,NP0,1005	2	SA	
....4	T0052	2703-002268	INDUCTOR-SMD;8.2nH,5%,1005	4	SNA	
....4		3701-001693	CONNECTOR-HDMI;19P,2ROW,FEMALE,SMD-A	1	SA	
....4	AD480	2203-006144	C-CER,CHIP;4700nF,10%,16V,X7R,3216	1	SA	
....4	C	2402-001314	C-AL,SMD;100uF,20%,16V,WT,TP,6x5.8mm	1	SA	

5. Exploded View & Part List

5-1. LA46C550J1F Exploded View

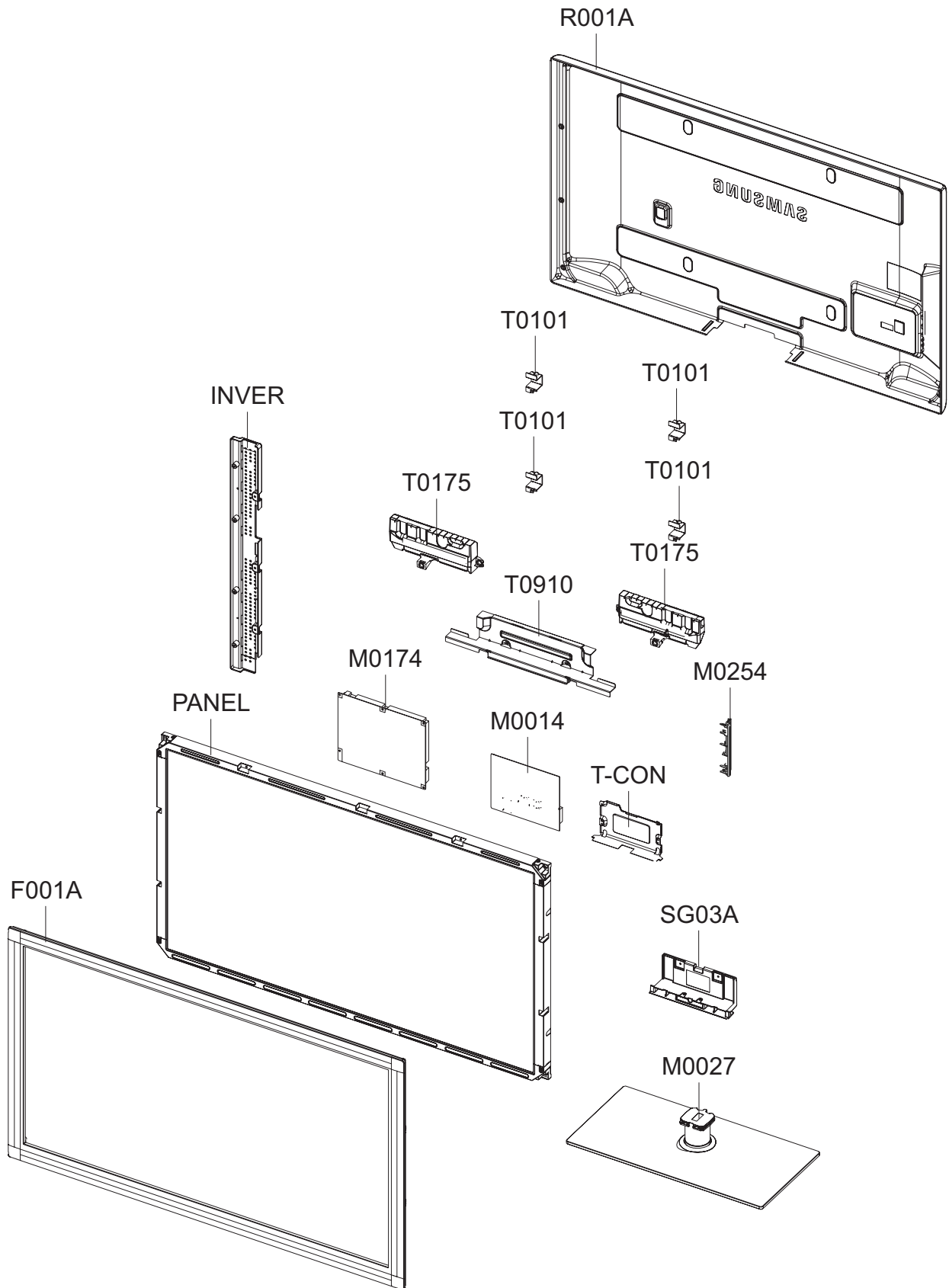

5-2. LA46C550J1F Parts List

Location No.	Code No.	Description & Specification	Q'ty	SA/SNA	Remark
F001A	BN96-12809E	ASSY COVER P-FRONT;46,LC550,CHINA(DTV),P	1	SA	
PANEL	BN07-00815A	LCD-PANEL;LTF460HM01,SSEZMS,8bit,46,16.7	1	SA	
TCON	BN81-04157A	A/S-T CON LTF460HM01;LTF460HM01	1	SA	
INVER	BN81-04173A	A/S-BB-L LTF460HM01;LTF460HM01	1	SA	
M0174	BN44-00341A	IP BOARD-TV;PSIV281510A,I46F1_ASM,14mA,1	1	SA	
M0014	BN94-03740A	ASSY PCB MAIN;LA46C550J1F,N82A,DTV	1	SNA	
M0254	BN61-06066B	HOLDER-SIDE AV;LC550,PMMA+ABS,HB,BK0007	1	SNA	
T0910	BN96-13342A	ASSY BRACKET P-STAND LINK;LC530 37/40/46	1	SNA	
T0175	BN96-12837B	ASSY SPEAKER P;6ohm,4pin,10W,L:630 R:290	1	SA	
T0101	BN61-05997A	BRACKET-WALL;LC650 46,SECC,T1.6	4	SNA	
R001A	BN96-12768T	ASSY COVER P-REAR;46,LC550,XZ(DTV),PCM,T	1	SA	
SG03A	BN96-12795D	ASSY STAND P-GUIDE;37,40,46,LC650,W/W,PC	1	SA	
M0027	BN96-12763A	ASSY STAND P-BASE;46,EXPORT,TEMPERED GLA	1	SA	

5-2-1. LA46C550J1F Parts List

Service Bom (SA: SERVICE AVAILABLE, SNA: SERVICE NOT AVAILABLE)

Level	Location No.	Code No.	Description & Specification	Q'ty	SA/SNA	Remark
			LA46C550J1FXXZ			
0.1	S001A	BN90-02444B	ASSY STAND;46,LC650,W/W,2COAT,ROSE BLACK	1	SNA	
..2	M0027	BN96-12763A	ASSY STAND P-BASE;46,EXPORT,TEMPERED GLA	1	SA	
...3	M0081	6003-001003	SCREW-TAPTYPE;BH,+ ,B,M4,L12,ZPC(BLK),SWR	6	SA	
...3		BN61-04692A	BOSS-PRIMER;#94,clear,35cps	0.1	SNA	
...3		BN61-04731D	BOSS-TAPE;AMBER,ACRYL,T1.1,W20.0mm,WHITE	0.39	SNA	
...3		BN61-05244A	BRACKET-SWIVEL BOTTOM;LB700 46,HGI,T3.0	1	SNA	
...3		BN61-05493A	HOLDER-SWIVEL RING BOTTOM;LB650 40,Aceta	1	SNA	
...3		BN61-05826A	BOSS-BOND;#760,Poly urethane,Black	2.4	SNA	
...3	GSN01	BN61-05994A	GUIDE-STAND NECK;40,LC650,PETG,V2,TP0003	1	SNA	
...4		BN61-06079B	GUIDE-NECK-INSERT;LC650 40,PETG HB,TP000	1	SNA	
...3	CCM1	BN63-04755A	COVER-SHEET;AMBER,PE,T0.05,W150mm,200M,6	1.22	SNA	
...3		BN63-05227D	COVER-STAND GLASS;46,LC650,GLASS,T8.0,2C	1	SNA	
...3	T0527	BN68-01648B	LABEL WARNING;WW,PET,T0.05,40,25,EXPORT	1	SNA	
...3	M0126	BN73-00215A	RUBBER-FOOT;40LB650,RUBBER,15*25,60,4.0,	4	SNA	
...3	M0126	BN73-00217A	RUBBER-FOOT;LB650,RUBBER,DIA30,7.5,Dark	4	SNA	
...3		BN74-00031A	GREASE;kanto-kasei FL-955,grease,wht	0.4	SNA	
...3	FD01	BN63-06913A	COVER-DECORATION;LB7000 46,ABS+PMMA,HB,H	1	SNA	
...3		BN61-05652C	BRACKET-STAND BOTTOM;B650 40,SGCC,T2.0,V	1	SNA	
..2	SG03A	BN96-12795D	ASSY STAND P-GUIDE;37,40,46,LC650,W/W,PC	1	SA	
...3	T0920	BN61-06003A	GUIDE-STAND;37,40,46,LC650,PC+G/F,20%,V2	1	SNA	
...3		BN68-02766B	MANUAL FLYER-STAND GUIDE;L550~L750,SAMSU	1	SNA	
...3		BN96-12031G	ASSY ACCESSORY-SCREW;10 LCD-TV,6003-0010	1	SNA	
...4	M0081	6003-001003	SCREW-TAPTYPE;BH,+ ,B,M4,L12,ZPC(BLK),SWR	9	SA	
...4	T0524	6902-000341	BAG PE;LDPE,T0.05,L90,W70,TRP,,,PE MARK	1	SNA	
...3	T0524	6902-001063	BAG PE;LDPE,T0.05,W180,L350,TRP,RECYCLE	1	SNA	
0.1	R001A	BN90-02449T	ASSY COVER REAR;46,LC650	1	SNA	
..2	M0081	6003-001003	SCREW-TAPTYPE;BH,+ ,B,M4,L12,ZPC(BLK),SWR	14	SA	
..2	R001A	BN96-12768T	ASSY COVER P-REAR;46,LC550,XZ(DTV),PCM,T	1	SA	
...3	R001	BN63-06337D	COVER-REAR;46,LC550,SO,PCM,T0.5,BLK	1	SNA	
...3		BN64-01270Q	INLAY-AV;LC550,CO,PS SHEET,T0.5	1	SNA	
...3	T0071	BN64-01297F	INLAY-TERMINAL;LC550,XZ(DTV),PS SHEET,T0	1	SNA	
...3	T0139	BN65-00003A	CLAMPER BAG;42C7,LDPE,HB,BLK	1	SNA	
...3	AH358	BN61-06545A	HOLDER-REAR;LC650 37/40/46,PP,BLK	1	SNA	
...3		BN63-06630A	SHEET-INSULATOR SMPS;UC6100 40inch,PC,T0	1	SNA	
...3		BN60-00162X	SPACER-FOAM;FOAM,30000mm,Dark Gray,1T,15	1.95	SNA	
0.1		BN90-02475E	ASSY COVER FRONT;LA46C550J1FXXZ	1	SNA	
..2	F001A	BN96-12809E	ASSY COVER P-FRONT;46,LC550,CHINA(DTV),P	1	SA	
...3	AB326	BN61-04661A	BRACKET-STOPPER;L650,SK-5,T0.4,Plating,H	5	SNA	
...3	CCM1	BN63-02183H	COVER-SHEET;Rhcm,PE Vinyl,T0.04,1300mm,2	0.84	SNA	
...3	F001	BN63-06387E	COVER-FRONT;46,LC550,CHINA(DTV),PMMA+PMM	1	SNA	
...3		BN96-12778B	ASSY HOLDER P-BOSS BOTTOM;46,LC630,ABS,H	1	SNA	
...4		BN61-04731A	BOSS-TAPE;AMBER,ACRYL,T1.1,W8.0mm,WHITE	0.51	SNA	
...4		BN61-06076B	HOLDER-BOSS BOTTOM;46,LC630,ABS,HB,WT003	1	SNA	
...3		BN63-05940J	COVER-SHEET;PE,T0.08,720mm,200M,CLEAR,40	2	SNA	
...3		BN60-00163D	SPACER-FOAM;LC650-46",FOAM,590,0.5,25,Bo	2	SNA	
...3		BN60-00163J	SPACER-FOAM;LC650-46",FOAM,1024,T 0.5,20	1	SNA	

5. Exploded View & Part List

Level	Location No.	Code No.	Description & Specification	Q'ty	SA/SNA	Remark
...3	M0125	BN96-13451C	ASSY BOARD P-TOUCH FUNCTION&IR;LN46C550J	1	SA	
...3		BN74-00052A	TAPE-PAPER;LB530,Crepe Paper,0.17mm, 10m	0.05	SNA	
..2	T0175	BN96-12837B	ASSY SPEAKER P;6ohm,4pin,10W,L:630 R:290	1	SA	
0.1		BN91-04897A	ASSY LCD-AMLCD;BN07-00815A	1	SNA	
..2	PANEL	BN07-00815A	LCD-PANEL;LTF460HM01,SSEZMS,8bit,46,16.7	1	SA	
...3	TCON	BN81-04157A	A/S-T CON LTF460HM01;LTF460HM01	1	SA	
...3	INVER	BN81-04173A	A/S-BB-L LTF460HM01;LTF460HM01	1	SA	
0.1		BN91-05276C	ASSY SHIELD;LA46C550J1FXXZ	1	SNA	
..2	T0081	6001-002284	SCREW-MACHINE;BH,+,M4,L8,ZPC(WHT),SWRCH1	10	SA	
..2	M0081	6003-000337	SCREW-TAPTYPE;BH,+,S,M4,L10,ZPC(BLK),SWR	6	SA	
..2	M0081	6003-001003	SCREW-TAPTYPE;BH,+,B,M4,L12,ZPC(BLK),SWR	6	SA	
..2	M0174	BN44-00341A	IP BOARD-TV;PSIV281510A,I46F1_ASM,14mA,1	1	SA	
..2	M0523	BN96-12974A	ASSY BRACKET P-WALL;46,52,55,LC650,SECC,	4	SNA	
...3	T0101	BN61-05997A	BRACKET-WALL;LC650 46,SECC,T1.6	4	SNA	
...3		BN60-00188A	SPACER-FOAM;LCD,FELT,20,3.0,30,Center :	4	SNA	
..2	M0230	BN96-13171D	ASSY CABLE P-FFC;LN46C530F1FXZA,FFC,0.5m	1	SA	
..2	T0910	BN96-13342A	ASSY BRACKET P-STAND LINK;LC530 37/40/46	1	SNA	
...3		BN61-02429K	STUD-PEM;PNB,M3.8,D7,L14.9,ZPC(SIL),SUM2	2	SNA	
...3	M0115	BN61-05998A	BRACKET-STAND LINK;LC650 46,SECC,T1.6	1	SNA	
...3		BN61-05281A	HOLDER-CLAMP;LCD,NYLON 66,WHT	3	SNA	
..2	M2893	BN39-01024E	LEAD CONNECTOR;LC5F,UL3239#24,2P,175mm,1	1	SA	
..2	T0081	6001-002604	SCREW-MACHINE;BH,+,M4,L10,ZPC(WHT),SWRCH	2	SA	
..2		BN61-06441A	HOLDER-INLET;LC530,ABS,V0	1	SNA	
..2	CCMM1	BN73-00264A	SILICON/RUBBER;LE32C530F1WXXC,SILICON+PO	1	SNA	
..2	M2893	BN39-01279F	LEAD CONNECTOR;LN46C650L1FXZA,UL1061 #28	1	SA	
0.1		BN92-05857A	ASSY P/MATERIAL;46,LC650	1	SNA	
..2	T0214	0203-001595	TAPE-OPP MASKING;OPP-2,0.075,75,800M,CLR	3.03	SNA	
..2		6902-000061	BAG AIR;LDPE,T0.2,W500,L1000,TRP,370.000	1	SNA	
..2		6902-000379	BAG AIR;LDPE,T0.2,W1000,L1800,TRP,1260.0	1	SNA	
..2		6902-000604	BAG WRAPPING;LDPE,T0.02,W500,L10000,TRP,	6.12	SNA	
..2		6902-000609	BAG ROLL;LDPE,T0.05,W2400,L1000,TRP,30.0	0.13	SNA	
..2		BN69-00391E	PAD-ANGLE;DI19PS,B400 PAPER,T5,50,1500,Y	1	SNA	
..2	T0246	BN69-04339A	CUSHION-01,SET;46LC550/630/640/650/670-G	1	SNA	
..2		BN68-02422B	LABEL-WARNING SHIPPING;ALL MODEL,A/P 100	1	SNA	
..2		6902-001183	BAG PE;HDPE/NITRON,T0.015/T0.5,W1300,L90	1	SNA	
..2		6902-001126	BAG SHEET;HDPE/NITRON,T0.015/T1.0,W500,L	1	SNA	
..2	M040	6922-000013	BAND PP;PP,W18,L2300m,TRP,21000g	1.45	SNA	
0.1		BN92-05898E	ASSY BOX;LA46C550J1FXXZ	1	SNA	
..2		BN69-04653G	BOX-SET;46LC550-S,CB,A-01,DW2,ECT50,YEL,	1	SNA	
..2		BH68-00662A	LABEL BOX-00;ALL MODEL,MOJO 90G,60,110,W	1	SNA	
0.1		BN92-05951A	ASSY LABEL;LA40C550J1FXXZ,LC550,N82A	1	SNA	
..2	T0527	BP68-00052B	LABEL-00,RATING;CCTV,TETRON PAPER,T0.05,	1	SNA	
0.1	ACCE1	BN92-06011A	ASSY ACCESSORY;LA46C550J1FXXZ,LC550,N82A	1	SNA	
..2		BN96-13621A	ASSY ACCESSORY-MANUAL;LA32C550J1FXXZ,LC5	1	SNA	
...3	T0524	6902-000110	BAG PE;LDPE,T0.05,W250,L400,TRP,28,2,9.2	1	SNA	
...3	T0527	AA68-00764A	LABEL-PASSING;SAMSUNG ALL,ART PAPER,CLR,	1	SNA	
...3	T0527	AA68-02517A	LABEL;PJTV(TTSEC),COPPERPLATE,50,75,YELL	1	SNA	
...3	T0059	AA68-03184A	MANUAL FLYER-CARD-07;ALL MODEL,CHINESE,2	1	SNA	
...3	T0527	BN68-00513A	LABEL-E,PASS;ALL MODEL,YUPO(110G),50X15,	1	SNA	
...3		BN68-02186A	MANUAL FLYER-TOC GUIDE;COMM,SAMSUNG,11 L	1	SNA	
...3		BN68-02515A	MANUAL USERS;LC550&530&480&360,SAMSUNG,S	1	SNA	

5. Exploded View & Part List

Level	Location No.	Code No.	Description & Specification	Q'ty	SA/SNA	Remark
.2	ACCE2	BN96-13889A	ASSY ACCESSORY-CABLE;LA46C550J1FXXZ,LC55	1	SNA	
...3	T0268	3903-000434	CBF-POWER CORD;DT,CN,IP3/YES,IEC320 C13-	1	SA	
...3	T0524	6902-001107	BAG PE;LDPE,T0.05,W450,L400,TRP,0,3Separ	1	SNA	
...3	M9889	BN63-01798B	CLOTH-CLEAN;cloth,180,200,sea blue,ToC	1	SA	
...3	T0531	BN63-06339A	COVER-BOTTOM;37,40,46,LC650,HIPS,HB,BK00	1	SA	
...3	T0527	BN68-00513A	LABEL-E,PASS;ALL MODEL,YUPO(110G),50X15,	1	SNA	
...3	T0010	BN96-08624A	ASSY HOLDER P;08 PDP MODEL,ABS HB,GRAY	1	SNA	
...4	T0010	BN61-04529A	HOLDER-RING;ABS, HB,GRAY	4	SNA	
...4		6902-000683	BAG ZIPPER;LDPE,T0.05,W60,L60,TRP,4-PE M	1	SNA	
...3		BN61-05596A	HOLDER-WIRE CABLE;LED TV,LDPE,T0.8,L150,	1	SNA	
...3		BN43-00004A	BATTERY;BM1L,BATTERY,MN,600mAh,7.9g	2	SNA	
...3	REMO2	BN59-01017A	REMOCON;TM1050,SAMSUNG,20PIN SINGLE,48KE	1	SA	
...3	M0254	AA59-00416A	ANT SHIELD BOX;UGC-AS-001A,PAL-BG,DK,I,M	1	SA	
0.1	M0017	BN91-05822A	ASSY CHASSIS;LA46C550J1F,N82A,DTV	1	SNA	
.2	M0014	BN94-03740A	ASSY PCB MAIN;LA46C550J1F,N82A,DTV	1	SNA	
...3		0202-001608	SOLDER-WIRE FLUX;LFC7-107,D0.8,99.3Sn/0.	0.25	SNA	
...3		3701-001480	CONNECTOR-DSUB;15P,3R,FEMALE,STAMPED PIN	1	SA	
...3	CN906	3707-001096	CONNECTOR-OPTICAL;STRAIGHT W/L,SPDIF	1	SA	
...3		3711-007302	HEADER-BOARD TO BOARD;BOX,18P,2R,2mm,ANG	1	SA	
...3		3722-003037	JACK-USB;4P/1C W/L,AU/NI,BLK,ANGLE,A	1	SA	
...3	JA330	3722-003038	JACK-PHONE;7P/1C W/L,SN,BLK	2	SA	
...3	JA333	3722-003040	JACK-PIN;3P W/L,SN,BLK/YEL/WHT/RED,ANGLE	1	SA	
...3	JA333	3722-003052	JACK-PIN;5P+Shield W/L,NI/SN,GN/BL/RD/WH	2	SA	
...3		3722-003058	JACK-MODULAR;8P/8C W/L,Y,STRAIGHT,N,AU,1	1	SA	
...3		3722-003088	JACK-USB;4P/1C,NI/PD/AU/SN,GRY,STRAIGHT,	1	SA	
...3	M2893	BN39-01267F	LEAD CONNECTOR;LB6T,UL2651#26,18P,350mm,	1	SA	
...3	ET01	BN40-00183A	TUNER;DNCS443VL161A(S),DTMB/PAL/NTSC,75o	1	SA	
...3	M0254	BN61-06066B	HOLDER-SIDE AV;LC550,PMMA+ABS,HB,BK0007	1	SNA	
...3	T0066	BN62-00040A	HEAT SINK-ES;SAPPHIRE,T2.0,36*36*6.6,BLK	1	SNA	
...3	M0412	BN96-11826C	ASSY BRACKET P-PCB;LB450 40,SPTE T0.5 +	1	SNA	
...4		BN61-04928C	BRACKET-SUPPORT PCB;SPTE,T 0.5,SCREW-M4	1	SNA	
...4		BN61-05262B	HOLDER-BOSS PCB;52,LB550(EO),PBT+G/F(30%	1	SNA	
...3		BN97-04052A	ASSY SMD-MAIN;SX1 550,DTV	1	SNA	
...4	DS01A	0401-001056	DIODE-SWITCHING;MMBD4148SE,100V,200mA,SO	16	SA	
...4		0403-001164	DIODE-ZENER;MMSZ5232B,5.32-5.88V,500MW,S	1	SA	
...4		0403-001783	DIODE-ZENER;BZB84-C6V2,5.8/6.6V,300mW,SO	15	SNA	
...4	D0254	0404-001271	DIODE-SCHOTTKY;SSA34,40V,3000mA,SMA,TP	1	SA	
...4	D0254	0404-001404	DIODE-SCHOTTKY;BAT721C,40V,200mA,SOT-23,	1	SA	
...4	T0139	0406-001200	DIODE-TVS;RCLAMP0504F,6/-V,150W,SC-70	2	SA	
...4	T0139	0406-001271	DIODE-TVS;RCLAMP0524P,6/-V,150W,SLP251	9	SNA	
...4	SD3	0407-000114	DIODE-SWITCHING;KDS184,80V,100mA,SOT-23,	3	SNA	
...4	Q101	0501-000445	TR-SMALL SIGNAL;KTC3875S-Y,NPN,150mW,SOT	8	SA	
...4	CEQ2	0505-000110	FET-SILICON;2N7002,N,60V,115mA,7.5ohm,0.	8	SA	
...4	Q409	0505-000274	FET-SILICON;AO4435L,P,-30V,-11A,0.014ohm	1	SNA	
...4	T0596	0904-002554	IC-USC;AU6256-JBF,QFN,28P,5x5mm,12MHz,TP	1	SA	
...4	IC106	1001-001573	IC-VIDEO SWITCH;Sii9287BCNUTR,QFN,72P,10	1	SNA	
...4		1006-001266	IC-LINE TRANSCEIVER;3232,TSSOP,16P,174MI	1	SA	
...4		1006-001474	IC-LINE DRIVER;DRV604PWP,HPSSOP,28P,9.8x	1	SA	
...4	IC112	1103-000129	IC-EEPROM;24C02,2Kbit,256x8,SOP,8P,5x4mm	2	SA	
...4	IC112	1103-001385	IC-EEPROM;AT24C256,256Kbit,32Kx8,SOP,8P,	1	SA	
...4		1105-002058	IC-DDR2 SDRAM;K4T1G164QE-HCF8,DDR2,1Gbit	2	SA	

5. Exploded View & Part List

Level	Location No.	Code No.	Description & Specification	Q'ty	SA/SNA	Remark
...4	T0124	1201-002992	IC-POWER AMP;STA369BWS,PSSO,36P,10.3x7.5	1	SA	
...4	T0087	1203-001815	IC-POSI.FIXED REG.;78M09,TO-252,3P,PLAST	1	SA	
...4	T0087	1203-002835	IC-POSI.FIXED REG.;KIA7805AF,DPAK,3P,6.6	1	SA	
...4	T0087	1203-002898	IC-POSI.FIXED REG.;G950T45R,T0-252,3P,6.	1	SA	
...4		1203-004364	IC-VOL. DETECTOR;RT9818C-42PV,SOT-23,3P,	1	SA	
...4	T0087	1203-005134	IC-POSI.FIXED REG.;RT9167A-33PB,SOT-23-5	1	SNA	
...4		1203-005559	IC-BACKLIGHT DRIVER;MP3302DJ,TSOT23,5P,2	1	SA	
...4		1203-006013	IC-DC/DC CONVERTER;AOZ1031AI,SO-8,8P,4.9	2	SA	
...4		1203-006017	IC-VOL. DETECTOR;RT9824GJ8,TSOT23,8P,2.9	1	SA	
...4	T0087	1203-006135	IC-POSI.FIXED REG.;AP1117D-33-GZ-13-89,T	1	SA	
...4	T0087	1203-006136	IC-POSI.FIXED REG.;AP1117D-18-GZ-13-89,T	1	SA	
...4		1204-003096	IC-VIDEO DECODER;HIDTVPRO-SX,PBGA,580P,P	1	SA	
...4		1204-003117	IC-AUDIO PROCESSOR;MSP3455G,PMQFP,44P,13	1	SA	
...4		1205-003201	IC-BUS SWITCH;TC7WB125FK,SSOP,8P,2x2.3mm	2	SA	
...4		1205-003733	IC-SWITCH;AP2191MPG-13,MSOP-8L-EP,8P,2.9	1	SA	
...4		1205-003735	IC-SWITCH;AP2151WG-7,SOT25,5P,2.9x1.6mm,	1	SA	
...4		1405-001185	VARISTOR;24Vdc,1.6x0.8x0.36mm,TP	1	SA	
...4		1405-001271	VARISTOR;20Vdc,5A,1.0x0.5x0.6mm,TP	25	SA	
...4	R105	2007-000138	R-CHIP;100ohm,5%,1/16W,TP,1005	33	SNA	
...4	AR49	2007-000140	R-CHIP;1Kohm,5%,1/16W,TP,1005	5	SNA	
...4	MR306	2007-000141	R-CHIP;2.2Kohm,5%,1/16W,TP,1005	11	SNA	
...4	R319	2007-000143	R-CHIP;4.7Kohm,5%,1/16W,TP,1005	53	SNA	
...4	R104	2007-000148	R-CHIP;10Kohm,5%,1/16W,TP,1005	38	SNA	
...4	R102	2007-000149	R-CHIP;12Kohm,5%,1/16W,TP,1005	8	SA	
...4	HDR9	2007-000152	R-CHIP;20Kohm,5%,1/16W,TP,1005	2	SNA	
...4	MR36	2007-000153	R-CHIP;22Kohm,5%,1/16W,TP,1005	5	SNA	
...4	AR43	2007-000155	R-CHIP;27Kohm,5%,1/16W,TP,1005	2	SNA	
...4	MR13	2007-000157	R-CHIP;47Kohm,5%,1/16W,TP,1005	7	SNA	
...4	R123	2007-000159	R-CHIP;56Kohm,5%,1/16W,TP,1005	1	SNA	
...4	DR39	2007-000162	R-CHIP;100Kohm,5%,1/16W,TP,1005	2	SNA	
...4	R509	2007-000170	R-CHIP;1Mohm,5%,1/16W,TP,1005	1	SNA	
...4	R111	2007-000171	R-CHIP;0ohm,5%,1/16W,TP,1005	11	SNA	
...4	HDR17	2007-000172	R-CHIP;10ohm,5%,1/16W,TP,1005	4	SNA	
...4	R338	2007-000173	R-CHIP;22ohm,5%,1/16W,TP,1005	12	SNA	
...4	MR9	2007-000455	R-CHIP;18Kohm,1%,1/10W,TP,1608	1	SA	
...4	ER13	2007-000669	R-CHIP;2Kohm,1%,1/10W,TP,1608	1	SNA	
...4	R726	2007-000695	R-CHIP;3.3ohm,5%,1/10W,TP,1608	1	SNA	
...4		2007-000755	R-CHIP;330Kohm,1%,1/10W,TP,1608	1	SA	
...4	R124	2007-000775	R-CHIP;33Kohm,5%,1/16W,TP,1005	3	SNA	
...4		2007-001285	R-CHIP;5.6ohm,5%,1/16W,TP,1005	4	SA	
...4	OTR1	2007-001292	R-CHIP;33ohm,5%,1/16W,TP,1005	4	SNA	
...4	R326	2007-001325	R-CHIP;3.3Kohm,5%,1/16W,TP,1005	11	SNA	
...4	TR30	2007-007009	R-CHIP;75ohm,5%,1/16W,TP,1005	11	SNA	
...4		2007-007134	R-CHIP;39Kohm,1%,1/16W,TP,1005	1	SA	
...4	DR4	2007-007142	R-CHIP;10Kohm,1%,1/16W,TP,1005	4	SNA	
...4		2007-007156	R-CHIP;1ohm,5%,1/16W,TP,1005	6	SNA	
...4		2007-007316	R-CHIP;3.3Kohm,1%,1/16W,TP,1005	1	SNA	
...4		2007-007318	R-CHIP;1Kohm,1%,1/16W,TP,1005	9	SNA	
...4		2007-007334	R-CHIP;200Kohm,1%,1/16W,TP,1005	4	SNA	
...4		2007-007698	R-CHIP;5.1Kohm,1%,1/16W,TP,1005	1	SNA	
...4	MR11	2007-008015	R-CHIP;75ohm,1%,1/16W,TP,1005	9	SNA	

5. Exploded View & Part List

Level	Location No.	Code No.	Description & Specification	Q'ty	SA/SNA	Remark
....4		2007-008134	R-CHIP;12.4Kohm,1%,1/16W,TP,1005	2	SC	
....4		2007-008298	R-CHIP;49.9ohm,1%,1/16W,TP,1005	4	SA	
....4		2007-008593	R-CHIP;750ohm,1%,1/16W,TP,1005	1	SA	
....4	DAR09	2011-001262	R-NETWORK;22ohm,5%,1/16W,L,CHIP,8P,TP,2.	6	SA	
....4	DRP29	2011-001396	R-NETWORK;4.7Kohm,5%,1/16W,L,CHIP,8P,TP,	1	SA	
....4		2011-001448	R-NETWORK;10ohm,5%,1/16W,L,4P,T,1010	4	SA	
....4		2011-001449	R-NETWORK;22ohm,5%,1/16W,L,4P,TP,1010	5	SA	
....4		2011-001519	R-NETWORK;33OHM,5%,1/16W,L,CHIP,4P,TP,1.	3	SA	
....4		2011-001527	R-NETWORK;4.7Kohm,5%,1/16W,L,CHIP,4P,TP,	8	SNA	
....4		2011-001587	R-NETWORK;100ohm,5%,1/16W,L,CHIP-V,4P,TP	1	SNA	
....4		2011-001589	R-NETWORK;0ohm,5%,1/16W,L,CHIP-V,4P,TP,1	16	SNA	
....4	C4N08	2203-000140	C-CER,CHIP;1.5nF,10%,50V,X7R,1608	3	SNA	
....4	PC43	2203-000233	C-CER,CHIP;0.1nF,5%,50V,C0G,TP,1005	1	SA	
....4	MC302	2203-000425	C-CER,CHIP;.018nF,5%,50V,C0G,TP,1005	2	SA	
....4	C254	2203-000438	C-CER,CHIP;1nF,10%,50V,X7R,TP,1005	13	SA	
....4	AC139	2203-000491	C-CER,CHIP;2.2nF,10%,50V,X7R,1608	2	SA	
....4	V1233	2203-000575	C-CER,CHIP;220nF,10%,25V,X7R,TP,2012	6	SNA	
....4	MC9	2203-000627	C-CER,CHIP;.022nF,5%,50V,C0G,TP,1005	3	SNA	
....4	DC25	2203-000812	C-CER,CHIP;.033nF,5%,50V,C0G,1005	9	SA	
....4	CK40B	2203-000838	C-CER,CHIP;0.39NF,5%,50V,C0G,TP,1608	3	SNA	
....4	AD480	2203-000995	C-CER,CHIP;.047nF,5%,50V,C0G,TP,1005	2	SA	
....4	HDC5	2203-001072	C-CER,CHIP;0.056nF,5%,50V,NP0,1005	4	SA	
....4	C101	2203-001124	C-CER,CHIP;0.68NF,10%,50V,X7R,TP,1005	1	SA	
....4	AD480	2203-001412	C-CER,CHIP;0.03nF,5%,50V,NP0,TP,1005	10	SNA	
....4	AD480	2203-001428	C-CER,CHIP;470nF,10%,50V,X7R,TP,2012	2	SNA	
....4	C637	2203-001656	C-CER,CHIP;0.47nF,5%,50V,NP0,1608	3	SNA	
....4	AD480	2203-002285	C-CER,CHIP;10nF,10%,50V,X7R,1005	14	SNA	
....4	AD480	2203-002525	C-CER,CHIP;0.56nF,10%,50V,X7R,TP,1005	8	SNA	
....4	AD480	2203-005052	C-CER,CHIP;0.0033nF,0.25pF,50V,NP0,1005	2	SA	
....4	AC611	2203-005194	C-CER,CHIP;.22nF,10%,50V,X7R,TP,1608	1	SA	
....4	AAC1	2203-005249	C-CER,CHIP;100nF,10%,50V,X7R,TP,1608	11	SNA	
....4	AD480	2203-005968	C-CER,CHIP;4.7NF,10%,50V,X7R,TP,1005	2	SNA	
....4	AD480	2203-006104	C-CER,CHIP;1000nF,10%,50V,X7R,3225	1	SA	
....4	PC11	2203-006141	C-CER,CHIP;1000nF,10%,16V,X5R,1608	1	SNA	
....4	C102	2203-006158	C-CER,CHIP;100nF,10%,16V,X7R,1005	115	SNA	
....4	JC10	2203-006324	C-CER,CHIP;2200nF,10%,10V,X5R,1608	2	SA	
....4	AD480	2203-006336	C-CER,CHIP;10000nF,10%,25V,X5R,3216	20	SA	
....4	C125	2203-006361	C-CER,CHIP;10000nF,10%,10V,X5R,TP,2012	48	SC	
....4	HDC11	2203-006562	C-CER,CHIP;1000nF,10%,10V,X5R,TP,1005	14	SNA	
....4	AD480	2203-006824	C-CER,CHIP;4700nF,10%,10V,X5R,1608	1	SNA	
....4	AD480	2203-006841	C-CER,CHIP;1000nF,10%,16V,X5R,1005	15	SNA	
....4	AD480	2203-006992	C-CER,CHIP;0.33nF,5%,50V,C0G,TP,1005	2	SNA	
....4	AD480	2203-007270	C-CER,CHIP;10000nF,10%,10V,X5R,TP,1608	3	SNA	
....4	T0052	2703-000158	INDUCTOR-SMD;1uH,10%,2012	9	SA	
....4	VL6	2703-000398	INDUCTOR-SMD;10uH,10%,3225	5	SA	
....4	T0052	2703-001239	INDUCTOR-SMD;3.3uH,10%,1608	1	SA	
....4	T0052	2703-001778	INDUCTOR-SMD;3.3uH,20%,3225	2	SA	
....4	T0052	2703-003149	INDUCTOR-SMD;2.2uH,20%,5050	3	SA	
....4	T0052	2703-003150	INDUCTOR-SMD;4.7uH,20%,5050	4	SNA	
....4	X202	2801-003326	CRYSTAL-SMD;24MHz,30ppm,28-ABX,20pF,50oh	1	SA	
....4	X202	2801-004300	CRYSTAL-SMD;18.432MHz,30ppm,28-ABX,13pF,	1	SA	

5. Exploded View & Part List

Level	Location No.	Code No.	Description & Specification	Q'ty	SA/SNA	Remark
....4	X202	2801-004775	CRYSTAL-SMD;12MHz,30ppm,16pF,30ohm,TP	1	SNA	
....4	F103	2901-001506	FILTER-EMI SMD;5V,0.13A,0pF,2x1x0.5mm,TP	2	SA	
....4	T0568	3301-001236	BEAD-SMD;60ohm,1608	7	SNA	
....4	T0568	3301-002039	BEAD-SMD;26ohm,1608,TP	37	SA	
....4	T0313	3404-001207	SWITCH-TACT;12V,50mA,160gf,6.2X6.2,SPST	1	SA	
....4		3601-001374	FUSE-SURFACE MOUNT;32V,5A,FAST-ACTING,Hi	1	SNA	
....4		3701-001591	CONNECTOR-HDMI;19P,2ROW,FEMALE,SMD-S,AU	3	SNA	
....4	AC510	3708-002797	CONNECTOR-FPC/FFC/PIC;51P,0.50mm,SMD,AU,	1	SA	
....4		3710-002111	SOCKET-BOARD TO BOARD;60P,2R,0.5MM,SMD-S	1	SA	
....4	CON_US	3711-005616	HEADER-BOARD TO CABLE;BOX,10P,1R,2mm,SMD	1	SNA	
....4	HB01A	3711-007336	HEADER-BOARD TO CABLE;BOX,4P,1R,2.5mm,SM	1	SA	
....4		BN41-01407A	PCB MAIN;SA1,FR-4,4L,1.0,1.2T,192*195,SA	1	SNA	
....4	D0254	0402-000553	DIODE-SCHOTTKY;SS24/B240,40V,2000mA,DO-2	2	SA	
....4		2011-001427	R-NETWORK;0ohm,5%,1/16W,L,CHIP,8P,TP,2.0	1	SNA	
....4	L1103	2703-000403	INDUCTOR-SMD;22uH,10%,3225	1	SA	
....4		1203-005538	IC-DC/DC CONVERTER;AOZ1021HAIL,SOP,8P,4.	1	SA	
....4		1203-006288	IC-VOL. DETECTOR;RT9818B-18GV,SOT-23-3,3	1	SA	
....4	PR6	2007-000072	R-CHIP;47ohm,5%,1/10W,TP,1608	4	SNA	
....4	HDR7	2007-000139	R-CHIP;220ohm,5%,1/16W,TP,1005	3	SNA	
....4		2007-007135	R-CHIP;18Kohm,1%,1/16W,TP,1005	1	SNA	
....4	C711	2203-002982	C-CER,CHIP;6.8nF,10%,50V,X7R,1005	1	SA	
....4	HE4	2203-006474	C-CER,CHIP;2200nF,20%,6.3V,X5R,2012	2	SA	
....4		BN97-04281A	ASSY MICOM;T-TDT5DEUS-1002,N82A,MX25L400	1	SNA	
....5	IC115	1107-001580	IC-FLASH MEMORY;MX25L4005,4Mbit,512Kx8,S	1	SNA	
....4		BN97-04282A	ASSY MICOM;T-TDT5DCNC-1002.0,N82A,KFG1G1	1	SNA	
....5		1107-001818	IC-NAND FLASH;KFG1G16U2C-DIB6,1024Mbit,6	1	SNA	
....4		0202-001767	SOLDER-CREAM;LST-5710,D20~38,Sn-57Bi-1Ag	0.409	SNA	
....4	HR3	2007-000903	R-CHIP;430ohm,1%,1/10W,TP,1608	1	SNA	
....4		2007-001317	R-CHIP;910ohm,5%,1/16W,TP,1005	1	SNA	
....4		2007-002768	R-CHIP;6.2Kohm,1%,1/10W,TP,1608	1	SA	
....4		2007-007317	R-CHIP;2.2Kohm,1%,1/16W,TP,1005	1	SA	
....4		2007-008275	R-CHIP;30Kohm,1%,1/16W,TP,1005	1	SNA	
....4	DC87	2203-001153	C-CER,CHIP;.068nF,5%,50V,NP0,1005	2	SA	
....4	T0052	2703-002268	INDUCTOR-SMD;8.2nH,5%,1005	4	SNA	
....4		3701-001693	CONNECTOR-HDMI;19P,2ROW,FEMALE,SMD-A	1	SA	
....4	AD480	2203-006144	C-CER,CHIP;4700nF,10%,16V,X7R,3216	1	SA	
....4	C	2402-001314	C-AL,SMD;100uF,20%,16V,WT,TP,6x5.8mm	1	SA	

1. Precautions

1-1. Safety Precautions

Follow these safety, servicing and ESD precautions to prevent damage and to protect against potential hazards such as electrical shock.

1-1-1. Warnings

1. For continued safety, do not attempt to modify the circuit board.
2. Disconnect the AC power and DC power jack before servicing.

1-1-2. Servicing the LCD TV

1. When servicing the LCD TV, Disconnect the AC line cord from the AC outlet.
2. It is essential that service technicians have an accurate voltage meter available at all times. Check the calibration of this meter periodically.

1-1-3. Fire and Shock Hazard

Before returning the LCD TV to the user, perform the following safety checks:

1. Inspect each lead dress to make certain that the leads are not pinched or that hardware is not lodged between the chassis and other metal parts in the LCD TV.
2. Inspect all protective devices such as nonmetallic control knobs, insulating materials, cabinet backs, adjustment and compartment covers or shields, isolation resistor/capacitor networks, mechanical insulators, etc.
3. Leakage Current Hot Check (Figure 1-1):

WARNING : Do not use an isolation transformer during this test.

Use a leakage current tester or a metering system that complies with American National Standards Institute (ANSI C101.1, Leakage Current for Appliances), and Underwriters Laboratories (UL Publication UL1410, 59.7).

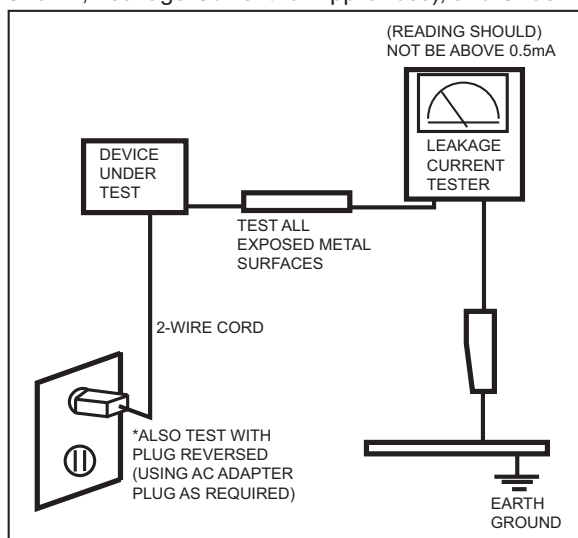

Figure 1-1. Leakage Current Test Circuit

4. With the unit completely reassembled, plug the AC line cord directly into a 120V AC outlet. With the unit's AC switch first in the ON position and then OFF, measure the current between a known earth ground (metal water pipe, conduit, etc.) and all exposed metal parts, including: metal cabinets, screwheads and control shafts. The current measured should not exceed 0.5 milliamp. Reverse the power-plug prongs in the AC outlet and repeat the test.

1-1-4. Product Safety Notices

Some electrical and mechanical parts have special safety-related characteristics which are often not evident from visual inspection. The protection they give may not be obtained by replacing them with components rated for higher voltage, wattage, etc. Parts that have special safety characteristics are identified by \triangle on schematics and parts lists. A substitute replacement that does not have the same safety characteristics as the recommended replacement part might create shock, fire and/or other hazards. Product safety is under review continuously and new instructions are issued whenever appropriate.

1-2. Servicing Precautions

WARNING: An electrolytic capacitor installed with the wrong polarity might explode.

Caution: Before servicing units covered by this service manual, read and follow the Safety Precautions section of this manual.

Note: If unforeseen circumstances create conflict between the following servicing precautions and any of the safety precautions, always follow the safety precautions.

1-2-1 General Servicing Precautions

1. Always unplug the unit's AC power cord from the AC power source and disconnect the DC Power Jack before attempting to:
(a) remove or reinstall any component or assembly, (b) disconnect PCB plugs or connectors, (c) connect a test component in parallel with an electrolytic capacitor.
2. Some components are raised above the printed circuit board for safety. An insulation tube or tape is sometimes used. The internal wiring is sometimes clamped to prevent contact with thermally hot components. Reinstall all such elements to their original position.
3. After servicing, always check that the screws, components and wiring have been correctly reinstalled. Make sure that the area around the serviced part has not been damaged.
4. Check the insulation between the blades of the AC plug and accessible conductive parts (examples: metal panels, input terminals and earphone jacks).
5. Insulation Checking Procedure: Disconnect the power cord from the AC source and turn the power switch ON. Connect an insulation resistance meter (500 V) to the blades of the AC plug. The insulation resistance between each blade of the AC plug and accessible conductive parts (see above) should be greater than 1 megohm.
6. Always connect a test instrument's ground lead to the instrument chassis ground before connecting the positive lead; always remove the instrument's ground lead last.

1-3. Electrostatically Sensitive Devices (ESD) Precautions

Some semiconductor (solid state) devices can be easily damaged by static electricity. Such components are commonly called Electrostatically Sensitive Devices (ESD). Examples of typical ESD are integrated circuits and some field-effect transistors. The following techniques will reduce the incidence of component damage caused by static electricity.

1. Immediately before handling any semiconductor components or assemblies, drain the electrostatic charge from your body by touching a known earth ground. Alternatively, wear a discharging wrist-strap device. To avoid a shock hazard, be sure to remove the wrist strap before applying power to the LCD TV.
2. After removing an ESD-equipped assembly, place it on a conductive surface such as aluminum foil to prevent accumulation of an electrostatic charge.
3. Do not use freon-propelled chemicals. These can generate electrical charges sufficient to damage ESDs.
4. Use only a grounded-tip soldering iron to solder or desolder ESDs.
5. Use only an anti-static solder removal device. Some solder removal devices not classified as "anti-static" can generate electrical charges sufficient to damage ESDs.
6. Do not remove a replacement ESD from its protective package until you are ready to install it. Most replacement ESDs are packaged with leads that are electrically shorted together by conductive foam, aluminum foil or other conductive materials.
7. Immediately before removing the protective material from the leads of a replacement ESD, touch the protective material to the chassis or circuit assembly into which the device will be installed.
Caution: Be sure no power is applied to the chassis or circuit and observe all other safety precautions.
8. Minimize body motions when handling unpackaged replacement ESDs. Motions such as brushing clothes together, or lifting your foot from a carpeted floor can generate enough static electricity to damage an ESD.

1-4. Installation Precautions

1. For safety reasons, more than a people are required for carrying the product.
2. Keep the power cord away from any heat emitting devices, as a melted covering may cause fire or electric shock.
3. Do not place the product in areas with poor ventilation such as a bookshelf or closet. The increased internal temperature may cause fire.
4. Bend the external antenna cable when connecting it to the product. This is a measure to protect it from being exposed to moisture. Otherwise, it may cause a fire or electric shock.
5. Make sure to turn the power off and unplug the power cord from the outlet before repositioning the product. Also check the antenna cable or the external connectors if they are fully unplugged. Damage to the cord may cause fire or electric shock.
6. Keep the antenna far away from any high-voltage cables and install it firmly. Contact with the highvoltage cable or the antenna falling over may cause fire or electric shock.
7. When installing the product, leave enough space (0.4m) between the product and the wall for ventilation purposes. A rise in temperature within the product may cause fire.

2. Product specifications

2-1. Feature & Specifications

Model	LA32C550J1F/LA32C530F1R	
Feature		
<ul style="list-style-type: none"> ▶ DTV/ATV, 4-HDMI, 2-Component, 2-A/V, D-SUB, 2-USB, 1-PC, 1LAN ▶ Brightness : 500cd/m² ▶ High Contrast Ratio : 60,000:1 ▶ Response Time : 6.5ms 		
Specifications		
Item	Description	
Input Jack	4-HDMI, 2-Component, 2-A/V, D-SUB, 2-USB, 1-PC, 1LAN	
Scanning Frequency	Horizontal : 50kHz~75kHz (Automatic) Vertical : 47kHz~63kHz (Automatic)	
Display Colors	16.7 million colors	
Maximum resolution	Horizontal : 1920 Pixels Vertical : 1080 pixels	
Input Signal	Analog 0.7 Vp-p ± 5% positive at 75Ω , internally terminated	
Input Sync Signal	H/V Separate, TTL, P. or N.	
Maximum Pixel Clock rate	300MHz	
Active Display Horizontal/Vertical	27.50 x 15.47 inches (698.4 (H) x 392.85 (V) mm)	
AC power voltage & Frequency	AC 100V~240V, 60 Hz	
Power Consumption	< 130W (< 0.3W, stand by)	
Dimensions Set (W x D x H)	30.8 x 8.7 x 21.1 inches (783.0 x 220.2 x 536.2 mm)_with stand 30.8 x 3.0 x 19.61 inches (783.0 x 76.2 x 497.5 mm)_without stand	
Weight (Set)	23.72 lbs (10.76kg)_with stand 19.31 lbs (8.76kg)_without stand	
TV System	Tuning	Frequency Synthesize (Refer to detailed Frequency Table)
	System	DVB-T, PAL, SECAM, NT4.43, NT3.58
	Sound	BG, DK, L/L', MPEG1, DD, DD+, HE-AAC
Environmental Considerations	Operating Temperature : 50°F ~ 104°F (10°C ~ 40°C) Operating Humidity : 10% ~ 80%, non-condensing Storage temperature : -13°F ~ 113°F (-25°C ~ 45°C) Storage Humidity : 5% ~ 95%, non-condensing	
Audio Spec.	<ul style="list-style-type: none"> - MAX Internal speaker Out : Right => 10W, Left => 10W - BASS Control Range : -8 dB ~ + 8dB - TREBLE Control Range : -8 dB ~ +8 dB - Output Frequency : RF : 80 Hz ~ 15 kHz A/V : 80 Hz ~ 20 kHz 	
Note: TruSurround HD, Film Mode, Energy Saving, Anynet+		

2. Product specifications

Model	LA37C550J1F/LA37C530F1R	
Feature		
<ul style="list-style-type: none"> ▶ DTV/ATV, 4-HDMI, 2-Component, 2-A/V, D-SUB, 2-USB, 1-PC, 1LAN ▶ Brightness : 500cd/m² ▶ High Contrast Ratio : 60,000:1 ▶ Response Time : 6.5ms 		
Specifications		
Item	Description	
Input Jack	4-HDMI, 2-Component, 2-A/V, D-SUB, 2-USB, 1-PC, 1LAN	
Scanning Frequency	Horizontal : 50kHz~75kHz (Automatic) Vertical : 47kHz~63kHz (Automatic)	
Display Colors	16.7 million colors	
Maximum resolution	Horizontal : 1920 Pixels Vertical : 1080 pixels	
Input Signal	Analog 0.7 Vp-p ± 5% positive at 75Ω , internally terminated	
Input Sync Signal	H/V Separate, TTL, P. or N.	
Maximum Pixel Clock rate	300MHz	
Active Display Horizontal/Vertical	27.50 x 15.47 inches (698.4 (H) x 392.85 (V) mm)	
AC power voltage & Frequency	AC 100V~240V, 60 Hz	
Power Consumption	< 130W (< 0.3W, Stand by)	
Dimensions Set (W x D x H)	35.5 x 9.4 x 24.2 inches (901.8x 240.0 x 613.6 mm)_with stand 35.5 x 3.0 x 22.1 inches (901.8 x 76.9 x 561.8 mm)_without stand	
Weight (Set)	31.39lbs (14.24kg)_with stand 25.00lbs (11.34kg)_without stand	
TV System	Tuning	Frequency Synthesize (Refer to detailed Frequency Table)
	System	DVB-T, PAL, SECAM, NT4.43, NT3.58
	Sound	BG, DK, L/L', MPEG1, DD, DD+, HE-AAC
Environmental Considerations	Operating Temperature : 50°F ~ 104°F (10°C ~ 40°C) Operating Humidity : 10% ~ 80%, non-condensing Storage temperature : -13°F ~ 113°F (-25°C ~ 45°C) Storage Humidity : 5% ~ 95%, non-condensing	
Audio Spec.	<ul style="list-style-type: none"> - MAX Internal speaker Out : Right => 10W, Left => 10W - BASS Control Range : -8 dB ~ + 8dB - TREBLE Control Range : -8 dB ~ +8 dB - Output Frequency : RF : 80 Hz ~ 15 kHz A/V : 80 Hz ~ 20 kHz 	
Note: TruSurround HD, Film Mode, Energy Saving, Anynet+		

Model	LA40C550J1F/LA40C530F1R	
Feature		
<ul style="list-style-type: none"> ▶ DTV/ATV, 4-HDMI, 2-Component, 2-A/V, D-SUB, 2-USB, 1-PC, 1LAN ▶ Brightness : 500cd/m² ▶ High Contrast Ratio : 60,000:1 ▶ Response Time : 6.5ms 		
Specifications		
Item	Description	
Input Jack	4-HDMI, 2-Component, 2-A/V, D-SUB, 2-USB, 1-PC, 1LAN	
Scanning Frequency	Horizontal : 50kHz~75kHz (Automatic) Vertical : 47kHz~63kHz (Automatic)	
Display Colors	16.7 million colors	
Maximum resolution	Horizontal : 1920 Pixels Vertical : 1080 pixels	
Input Signal	Analog 0.7 Vp-p ± 5% positive at 75Ω , internally terminated	
Input Sync Signal	H/V Separate, TTL, P. or N.	
Maximum Pixel Clock rate	300MHz	
Active Display Horizontal/Vertical	27.50 x 15.47 inches (698.4 (H) x 392.85 (V) mm)	
AC power voltage & Frequency	AC 100V~240V, 60 Hz	
Power Consumption	< 130W (< 0.3W, stand by)	
Dimensions Set (W x D x H)	38.2 x 9.4 x 25.7 inches (970.0x 240.0 x 651.7 mm)_with stand 3.8 x 3.1 x 23.6 inches (970.0 x 78.6 x 600.1 mm)_without stand	
Weight (Set)	38.14lbs (17.3kg)_with stand 31.75lbs (14.4kg)_without stand	
TV System	Tuning	Frequency Synthesize (Refer to detailed Frequency Table)
	System	DVB-T, PAL, SECAM, NT4.43, NT3.58
	Sound	BG, DK, L/L', MPEG1, DD, DD+, HE-AAC
Environmental Considerations	Operating Temperature : 50°F ~ 104°F (10°C ~ 40°C) Operating Humidity : 10% ~ 80%, non-condensing Storage temperature : -13°F ~ 113°F (-25°C ~ 45°C) Storage Humidity : 5% ~ 95%, non-condensing	
Audio Spec.	<ul style="list-style-type: none"> - MAX Internal speaker Out : Right => 10W, Left => 10W - BASS Control Range : -8 dB ~ + 8dB - TREBLE Control Range : -8 dB ~ +8 dB - Output Frequency : RF : 80 Hz ~ 15 kHz A/V : 80 Hz ~ 20 kHz 	
Note: TruSurround HD, Film Mode, Energy Saving, Anynet+		

2. Product specifications

Model	LA46C550J1F/LA46C530F1R	
Feature		
<ul style="list-style-type: none"> ▶ DTV/ATV, 4-HDMI, 2-Component, 2-A/V, D-SUB, 2-USB, 1-PC, 1LAN ▶ Brightness : 500cd/m² ▶ High Contrast Ratio : 60,000:1 ▶ Response Time : 6.5ms 		
Specifications		
Item	Description	
Input Jack	4-HDMI, 2-Component, 2-A/V, D-SUB, 2-USB, 1-PC, 1LAN	
Scanning Frequency	Horizontal : 50kHz~75kHz (Automatic) Vertical : 47kHz~63kHz (Automatic)	
Display Colors	16.7 million colors	
Maximum resolution	Horizontal : 1920 Pixels Vertical : 1080 pixels	
Input Signal	Analog 0.7 Vp-p ± 5% positive at 75Ω , internally terminated	
Input Sync Signal	H/V Separate, TTL, P. or N.	
Maximum Pixel Clock rate	310MHz	
Active Display Horizontal/Vertical	27.50 x 15.47 inches (698.4 (H) x 392.85 (V) mm)	
AC power voltage & Frequency	AC 100V~240V, 60 Hz	
Power Consumption	< 130W (< 0.3W, stand by)	
Dimensions Set (W x D x H)	43.4 x 10.2 x 28.9 inches (1102.4x 260.1 x 733.2 mm)_with stand 43.4 x 3.1 x 26.6 inches (1102.4 x 78.4 x 676.3 mm)_without stand	
Weight (Set)	45.50lbs (20.64kg)_with stand 36.90lbs (16.74kg)_without stand	
TV System	Tuning	Frequency Synthesize (Refer to detailed Frequency Table)
	System	DVB-T, PAL, SECAM, NT4.43, NT3.58
	Sound	BG, DK, L/L', MPEG1, DD, DD+, HE-AAC
Environmental Considerations	Operating Temperature : 50°F ~ 104°F (10°C ~ 40°C) Operating Humidity : 10% ~ 80%, non-condensing Storage temperature : -13°F ~ 113°F (-25°C ~ 45°C) Storage Humidity : 5% ~ 95%, non-condensing	
Audio Spec.	<ul style="list-style-type: none"> - MAX Internal speaker Out : Right => 10W, Left => 10W - BASS Control Range : -8 dB ~ + 8dB - TREBLE Control Range : -8 dB ~ +8 dB - Output Frequency : RF : 80 Hz ~ 15 kHz A/V : 80 Hz ~ 20 kHz 	
Note: TruSurround HD, Film Mode, Energy Saving, Anynet+		

Frequency (DTV)

Channel	UK	France	Germany	Italy	Spain	Sweden	Finland
VHF							
				[A] 56			
				[B] 64.5			
				[C] 84.5			
				[D] 177.5			
	[5] 178.75	[5] 177.5		[E] 186		[5] 177.5	[5] 177.5
	[6] 186.75	[6] 184.5	[6] 184.5	[F] 194.5		[6] 184.5	[6] 184.5
	[7] 194.75	[7] 191.5	[7] 191.5	[G] 203.5		[7] 191.5	[7] 191.5
	[8] 202.75	[8] 198.5	[8] 198.5	[H] 212.5		[8] 198.5	[8] 198.5
	[9] 210.75	[9] 205.5	[9] 205.5	[H1] 219.5		[9] 205.5	[9] 205.5
	[10] 218.75	[10] 212.5	[10] 212.5	[H2] 226.5		[10] 212.5	[10] 212.5
			[11] 219.5			[11] 219.5	[11] 219.5
			[12] 226.5			[12] 226.5	[12] 226.5
UHF							
21	474	474	474	474	474	474	474
22	482	482	482	482	482	482	482
23	490	490	490	490	490	490	490
24	498	498	498	498	498	498	498
25	506	506	506	506	506	506	506
26	514	514	514	514	514	514	514
27	522	522	522	522	522	522	522
28	530	530	530	530	530	530	530
29	538	538	538	538	538	538	538
30	546	546	546	546	546	546	546
31	554	554	554	554	554	554	554
32	562	562	562	562	562	562	562
33	570	570	570	570	570	570	570
34	578	578	578	578	578	578	578
35	586	586	586	586	586	586	586
36	594	594	594	594	594	594	594
37	602	602	602	602	602	602	602
38	610	610	610	610	610	610	610
39	618	618	618	618	618	618	618
40	626	626	626	626	626	626	626
41	634	634	634	634	634	634	634
42	642	642	642	642	642	642	642
43	650	650	650	650	650	650	650
44	658	658	658	658	658	658	658
45	666	666	666	666	666	666	666
46	674	674	674	674	674	674	674
47	682	682	682	682	682	682	682
48	690	690	690	690	690	690	690
49	698	698	698	698	698	698	698
50	706	706	706	706	706	706	706
51	714	714	714	714	714	714	714
52	722	722	722	722	722	722	722
53	730	730	730	730	730	730	730
54	738	738	738	738	738	738	738
55	746	746	746	746	746	746	746
56	754	754	754	754	754	754	754
57	762	762	762	762	762	762	762
58	770	770	770	770	770	770	770
59	778	778	778	778	778	778	778
60	786	786	786	786	786	786	786
61	794	794	794	794	794	794	794
62	802	802	802	802	802	802	802
63	810	810	810	810	810	810	810
64	818	818	818	818	818	818	818
65	826	826	826	826	826	826	826
66	834	834	834	834	834	834	834
67	842	842	842	842	842	842	842
68	850	850	850	850	850	850	850
69		858	858	858	858	858	858

2. Product specifications

Australia	Netherlands	China	Hongkong	Taiwan
[0] 48.5		[1]52.5		
[1] 59.5		[2]60.5		
[2] 66.5		[3]68.5		
[3] 88.5		[4]80		
[4] 97.5	[5] 174.5	[5]88		
[5] 104.5	[6] 181.5	[6]171		
[5A] 140.5	[7] 188.5	[7]179		
[6] 177.5	[8] 195.5	[8]187		
[7] 184.5	[9] 202.5	[9]195		
[8] 191.5	[10] 209.5	[10]203		
[9] 198.5	[11] 216.5	[11]211		
[9A] 205.5	[12] 223.5	[12]219		
[10] 212.5				
[11] 219.5				
[12] 226.5				
	474	[13]474	[21]474	[14]473
	482	[14]482	[22]482	[15]479
	490	[15]490	[23]490	[16]485
	498	[16]498	[24]498	[17]491
	506	[17]506	[25]506	[18]497
	514	[18]514	[26]514	[19]503
520~526.6MHz	522	[19]522	[27]522	[20]509
529.5	530	[20]530	[28]530	[21]515
536.5	538	[21]538	[29]538	[22]521
543.5	546	[22]546	[30]546	[23]527
550.5	554	[23]554	[31]554	[24]533
557.5	562	[24]562	[32]562	[25]539
564.5	570	[25]610	[33]570	[26]545
571.5	578	[26]618	[34]578	[27]551
578.5	586	[27]626	[35]586	[28]557
585.5	594	[28]634	[36]594	[29]563
592.5	602	[29]642	[37]602	[30]569
599.5	610	[30]650	[38]610	[31]575
606.5	618	[31]658	[39]618	[32]581
613.5	626	[32]666	[40]626	[33]587
620.5	634	[33]674	[41]634	[34]593
627.5	642	[34]682	[42]642	[35]599
634.5	650	[35]690	[43]650	[36]605
641.5	658	[36]698	[44]658	[37]611
648.5	666	[37]706	[45]666	[38]617
655.5	674	[38]714	[46]674	[39]623
662.5	682	[39]722	[47]682	[40]629
669.5	690	[40]730	[48]690	[41]635
676.5	698	[41]738	[49]698	[42]641
683.5	706	[42]746	[50]706	[43]647
690.5	714	[43]754	[51]714	[44]653
697.5	722	[44]762	[52]722	[45]659
704.5	730	[45]770	[53]730	[46]665
711.5	738	[46]778	[54]738	[47]671
718.5	746	[47]786	[55]746	[48]677
725.5	754	[48]794	[56]754	[49]683
732.5	762	[49]802	[57]762	[50]689
739.5	770	[50]810	[58]770	[51]695
746.5	778	[51]818	[59]778	[52]701
753.5	786	[52]826	[60]786	[53]707
760.5	794	[53]834	[61]794	[54]713
767.5	802	[54]842	[62]802	[55]719
774.5	810	[55]850	[63]810	[56]725
781.5	818	[56]858	[64]818	[57]731
788.5	826	[57]866	[65]826	[58]737
795.5	834	[58]874	[66]834	[59]743
802.5	842	[59]882	[67]842	[60]749
809.5	850	[60]890	[68]850	[61]755
816.5	858	[61]898	[69]858	[62]761
		[62]906		[63]767
		[63]914		[64]773
				[65]779
				[66]785
				[67]791
				[68]797
				[69]803

Frequency (ATV)

CH	CCIR (PAL B/G)		OIRT (SECAM D/K)		FRANCE (SECAM-L)		NEWZEAL	CHINA (PAL D/K)
1		69-855.25	49.25	69-855.25	176.00	69-855.25	45.25	49.25
2	48.25	E2-48.25	59.25		184.00	FA-47.75	55.25	57.25
3	55.25	E3-55.25	77.25		192.00	FB-55.75	62.25	65.25
4	62.25	E4-62.25	85.25		200.00	FC1-60.50	175.25	77.25
5	175.25	X -69.25	93.25		208.00	FC-53.75	182.25	85.25
6	182.25	Y -76.25	175.25		216.00	B-116.75	189.25	168.25
7	189.25	Z -83.25	183.25			C-128.25	196.25	176.25
8	196.25	Z1-90.25	191.25			D-140.75	203.25	184.25
9	203.25	Z2-97.25	199.25			E-152.75	210.25	192.25
10	210.25	S1-105.25	207.25			F-164.75	217.25	200.25
11	217.25	S2-112.25	215.25			F1-176.00	224.25	208.25
12	224.25	S3-119.25	223.25			G -176.75		216.25
13		S4-126.25				F2-184.00		471.25
14		S5-133.25				H -188.75		479.25
15		S6-140.25				F3-192.00		487.25
16		S7-147.25				F4-200.00		495.25
17		S8-154.25				I -200.75		503.25
18		S9-161.25				F5-208.00		511.25
19		S10-168.25				J -212.75		519.25
20		E5-175.25				F6-216.00		527.25
21	471.25	E6-182.25	471.25		471.25	K -224.75		535.25
22	479.25	E7-189.25	479.25		479.25	L -236.75		543.25
23	487.25	E8-196.25	487.25		487.25	M -248.75		551.25
24	495.25	E9-203.25	495.25		495.25	N -260.75		559.25
25	503.25	E10-210.25	503.25		503.25	O -272.75		607.25
26	511.25	E11-217.25	511.25		511.25	P -284.75		615.25
27	519.25	E12-224.25	519.25		519.25	Q -296.75		623.25
28	527.25	S11-231.25	527.25		527.25			631.25
29	535.25	S12-238.25	535.25		535.25			639.25
30	543.25	S13-245.25	543.25		543.25			647.25
31	551.25	S14-252.25	551.25		551.25			655.25
32	559.25	S15-259.25	559.25		559.25			663.25
33	567.25	S16-266.25	567.25		567.25			671.25
34	575.25	S17-273.25	575.25		575.25			679.25
35	583.25	S18-280.25	583.25		583.25			687.25
36	591.25	S19-287.25	591.25		591.25			695.25
37	599.25	S20-294.25	599.25		599.25			703.25
38	607.25	S21-303.25	607.25		607.25			711.25
39	615.25	S22-311.25	615.25		615.25			719.25
40	623.25	S23-319.25	623.25		623.25			727.25
41	631.25	S24-327.25	631.25		631.25			735.25
42	639.25	S25-335.25	639.25		639.25			743.25
43	647.25	S26-343.25	647.25		647.25			751.25
44	655.25	S27-351.25	655.25		655.25			759.25
45	663.25	S28-359.25	663.25		663.25			767.25
46	671.25	S29-367.25	671.25		671.25			775.25
47	679.25	S30-375.25	679.25		679.25			783.25
48	687.25	S31-383.25	687.25		687.25			791.25
49	695.25	S32-391.25	695.25		695.25			799.25
50	703.25	S33-399.25	703.25		703.25			807.25
51	711.25	S34-407.25	711.25		711.25			815.25
52	719.25	S35-415.25	719.25		719.25			823.25
53	727.25	S36-423.25	727.25		727.25			831.25
54	735.25	S37-431.25	735.25		735.25			839.25
55	743.25	S38-439.25	743.25		743.25			847.25
56	751.25	S39-447.25	751.25		751.25			855.25
57	759.25	S40-455.25	759.25		759.25			863.25
58	767.25	S41-463.25	767.25		767.25			871.25
59	775.25		775.25		775.25			879.25
60	783.25		783.25		783.25			887.25
61	791.25		791.25		791.25			895.25
62	799.25		799.25		799.25			903.25
63	807.25		807.25		807.25			911.25
64	815.25		815.25		815.25			919.25
65	823.25		823.25		823.25			927.25
66	831.25		831.25		831.25			935.25
67	839.25		839.25		839.25			943.25
68	847.25		847.25		847.25			951.25

2-2. New Features explanation

- ▶ Anynet+: Anynet+ is an AV network system that enables you to control all connected Samsung AV devices with the TV's remote.

To directly connect to TV

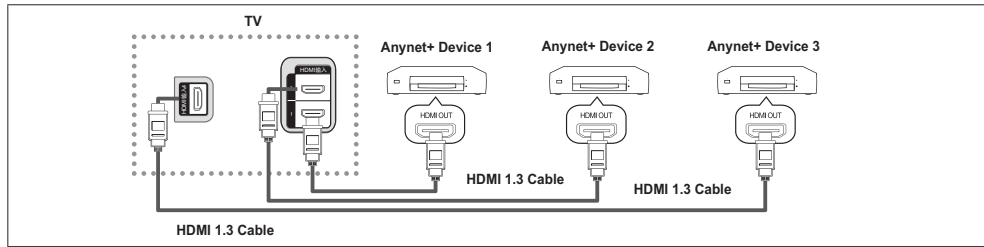

Connect the [HDMI 1], [HDMI 2] or [HDMI] jack on the TV and the HDMI OUT jack of the corresponding Anynet+ device using an HDMI cable.

To connect to Home Theater

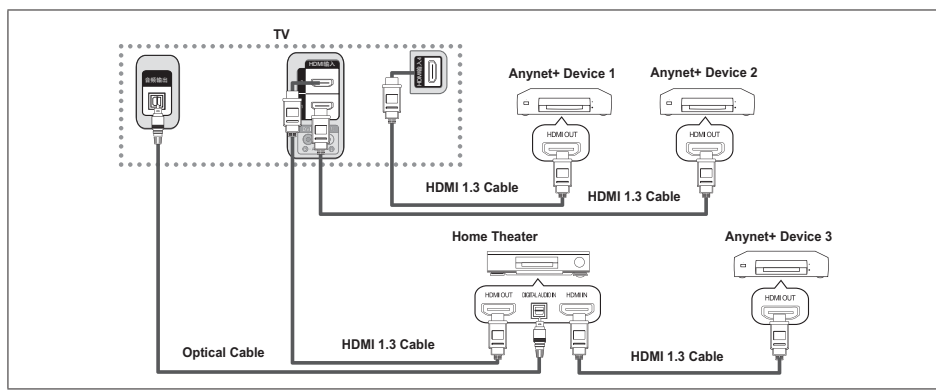

1. Connect the [HDMI 1], [HDMI 2] or [HDMI] jack on the TV and the HDMI OUT jack of the corresponding Anynet+ device using an HDMI cable.
2. Connect the HDMI IN jack of the home theater and the HDMI OUT jack of the corresponding Anynet+ device using the HDMI cable.







- Connect the Optical cable between [Digital Audio Out (Optical)] on your TV and Digital Audio Input on the Home Theater.
- When following the connection above, the Optical jack only outputs 2 channel audio. You will only hear sound from the Home Theater's Front Left and Right speakers and the subwoofer. If you want to hear 5.1 channel audi connect the DIGITAL AUDIO OUT (OPTICAL) jack on the DVD / Satellite Box (ie Anynet Device 1 or 2) directly to the Amplifi er or Home Theater, not the TV.
- Connect only one Home Theater.
- You can connect an Anynet+ device using the HDMI 1.3 cable. Some HDMI cables may not support Anynet+ functions.
- Anynet+ works when the AV device supporting Anynet+ is in the Standby or On status.
- Anynet+ supports up to 12 AV devices in total. Note that you can connect up to 3 devices of the same type.

2-3. Specification Comparison to Old Models

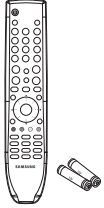
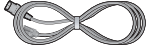
※ O : application, X : non-application

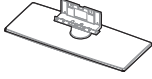
Model	C550(LA32C550)		B550(LA32B550)	
Design				
Display Type	LCD TV		LCD TV	
Built-in Tuner	O		O	
Resolution	1920 x 1080		1920 x 1080	
LCD Panel	TFT LCD Panel		TFT LCD Panel	
Screen Size	32"/37"/40"/46"		32"/37"/40"/46"	
Picture ratio	16 : 9		16 : 9	
Dimensions (W x H x D)	32"	31.2 x 9.4 x 21.9 inches_with stand	32"	31.3 x 9.4 x 22.4 inches_with stand
	37"	35.9 x 10.0 x 25.5 inches_with stand	37"	36.1 x 10.0 x 25.9 inches_with stand
	40"	38.6 x 10.0 x 26.0 inches_with stand	40"	38.7 x 10.0 x 26.6 inches_with stand
	46"	43.8 x 10.8 x 29.0 inches_with stand	46"	44.0 x 10.8 x 30.3 inches_with stand
Weight	32"	25.35 lbs_with stand	32"	27.78 lbs_with stand
	37"	32.85lbs_with stand	37"	35.27 lbs_with stand
	40"	40.12lbs_with stand	40"	39.68 lbs_with stand
	46"	47.84lbs_with stand	46"	51.15 lbs_with stand
Brightness	500 cd ²		500 cd ²	
Contrast Ratio	60,000:1		60,000:1	
Picture Enhacer	DNle (SETD-10)		DNle (SEMS12)	
Equalizer	5 Band		5 Band	
Auto Volume Control	O		O	
Surround Sound	SRS TruSurround HD		SRS TruSurround HD	
Speaker Output	10W + 10W		10W + 10W	
PIP	O		X	
Double Window	X		X	
TTX	X		X	
Entertainment Mode	X		X	
Game Mode	O		O	
Energy Saving	O		O	
Anynet+	O		O	
LAN	O		X	
DLAN	O		X	
Antenna	1(Cable/Air)		1(Cable/Air)	

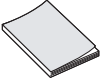
2-4. Accessories

Product	Description	Code. No	Remark
	Remote Control & Batteries (AAA x 2)	LC550 CN : BN59-01017A LC550 HK : BN59-01014A LC360 HK : BN59-01012A	
	Power Cord	CN : 3903-000434 HK : 3903-000461	
	Cover-Bottom	LA32C550/LC530/LC360 : BN63-06389A LA37C550/LA40C550/LA46C550/LC530 : BN63-06339A	
	Stand	BN96-09131D	
	Screw (for the stand - M4, L12)	6003-001003	Samsung Electronics Service center
	Owner's Instructions	LC550 CN : BN68-02515A(SC) LC550/LC530/LC360 HK : BN68-02515B(ENG) LC550/LC530/LC360 HK : BN68-02515C(TC)	
	Cleaning Cloth	BN63-01798B	
	Manual flyer card Label sticker Manual Flyer-Manual flyer safety guid Label Sticker	AA68-03184A(CN) AA68-03752D AA68-03242M(HK) AA68-03752D	

4. Troubleshooting

4-1. Troubleshooting

4-1-1. Previous check

1. Check the various cable connections first.
 - Check to see if there is a burnt or damaged cable.
 - Check to see if there is a disconnected or loose cable connection.
 - Check to see if the cables are connected according to the connection diagram.
2. Check the power input to the Main Board.

4-1-2. No Power

Symptom	<ul style="list-style-type: none"> - The LEDs on the front panel do not work when connecting the power cord. - The SMPS relay does not work when connecting the power cord. - The units appears to be dead.
Major checkpoints	<p>The IP relay or the LEDs on the front panel does not work when connecting the power cord if the cables are improperly connected or the Main Board or SMPS is not functioning. In this case, check the following:</p> <ul style="list-style-type: none"> - Check the internal cable connection status inside the unit. - Check the fuses of each part. - Check the output voltage of SMPS. - Replace the Main Board.
Diagnostics	<div style="text-align: center; margin-bottom: 10px;">  </div> <pre> graph TD Q1[Lamp(Backlight) Off, power indicator LED off?] -- No --> A1[Change the 18p power cable.] Q1 -- Yes --> Q2[Lamp(Backlight) Off, power indicator LED on?] Q2 -- No --> A2[Change INVERTER/BALANCE B'D.] Q2 -- Yes --> Q3[Does proper Stand-By DC A5V appear at TP - A5V1?] Q3 -- No --> A3[Change the Main Assy.] Q3 -- Yes --> Q4[Does proper Main DC B13V, B5V appear at TP - B13V1, B5V2?] Q4 -- No --> A3 Q4 -- Yes --> Q5[Does proper DC A3.3V appear at TP - A3.3V1?] Q5 -- No --> A3 Q5 -- Yes --> Q6[Does proper B3.3V, B1.8V, SPI_3.3V appear at TP - B3.3V1, B1.8V1, SPI_A3.3 ?] Q6 -- No --> A3 Q6 -- Yes --> Q7[Does proper DC B13V appear at LVDS connector Pin #1~5 of T-con b'd?] Q7 -- No --> A4[Change the LVDS cable.] Q7 -- Yes --> Q8[Does proper DC B13V appear at F1 of T-con b'd?] Q8 -- No --> A5[Change the T-con b'd.] Q8 -- Yes --> Q9[A power is supplied to set?] Q9 --> A6[Check a other function.(No picture part) Replace a LCD Panel.] </pre>
Caution	<p>Make sure to disconnect the power before working on the IP board.</p>

SW	RF_AGC	B+	GND	VT	GND	SCL	SDA	IF-TP	NC	NC	NC	NC	SIF	D12.V	CVBS	
A3.3V	TS_CLK	D0	D1	D2	D3	D4	D5	D6	D7	SYNC	VALID	ERROR	RESET	D3.3V	NC	D2.5V

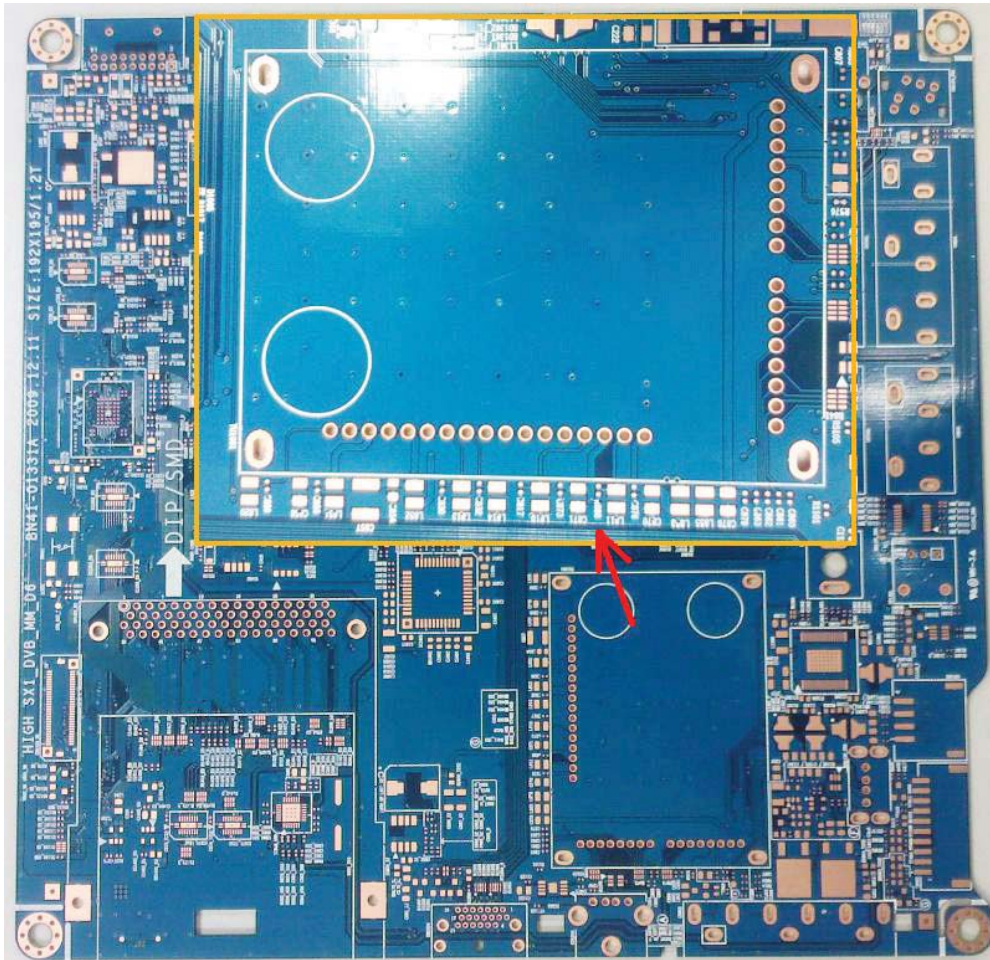

MAINBOARD(B)

4. Troubleshooting

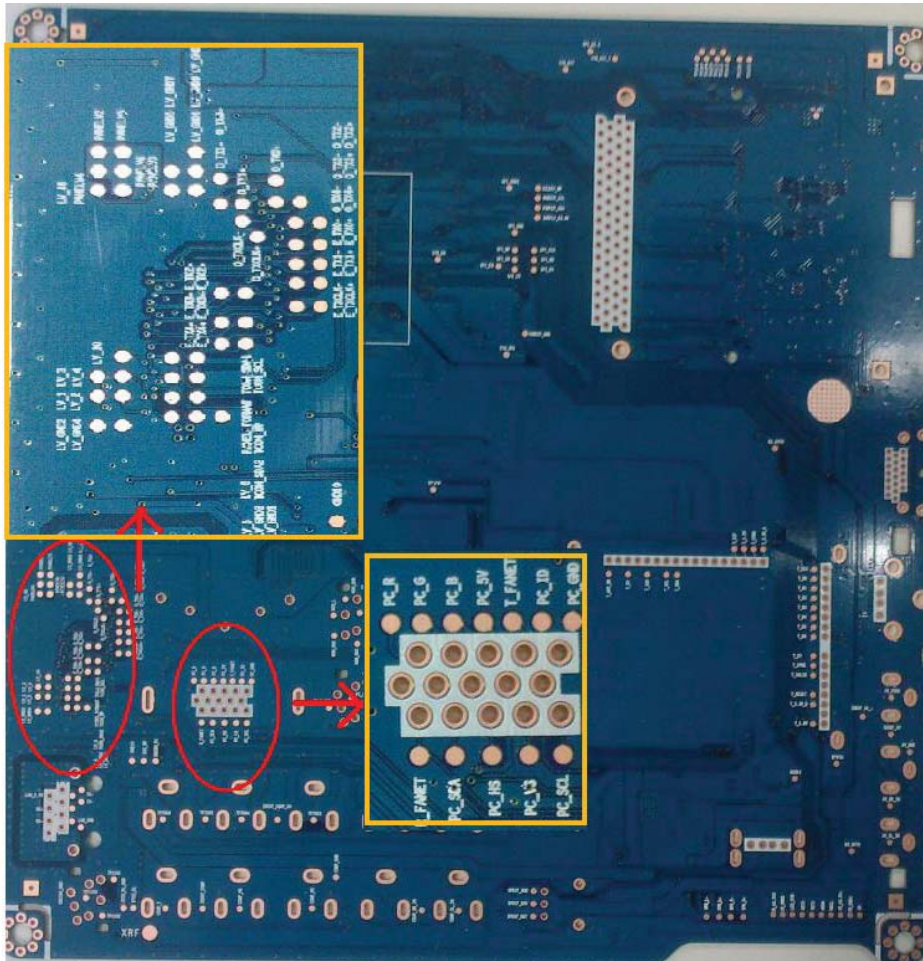

MAINBOARD(T)

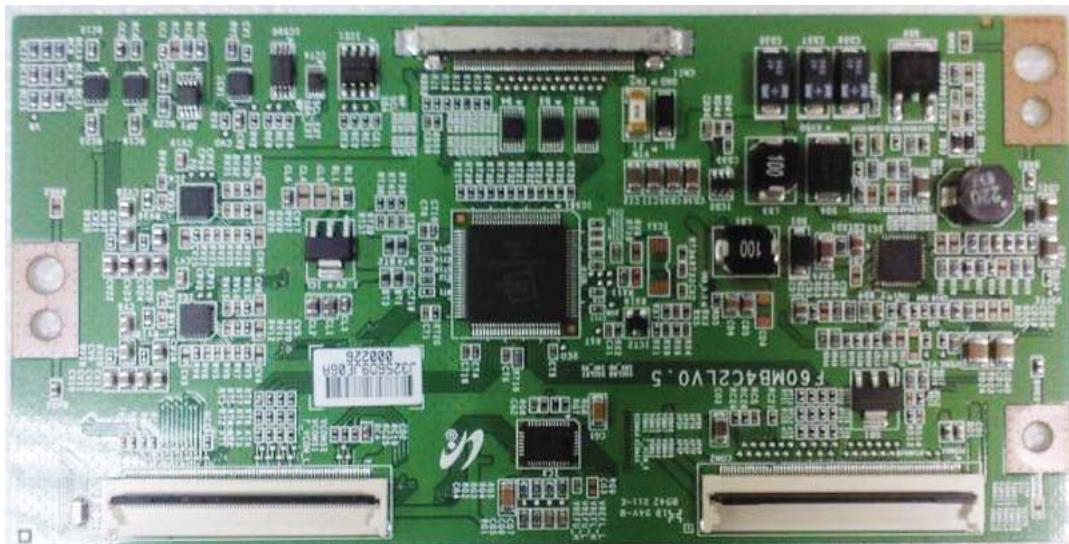

T-CON

4-1-3. No Video (Analog PC signal)

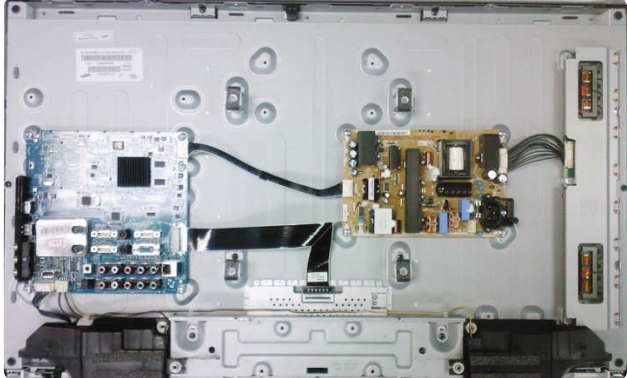
Symptom	<ul style="list-style-type: none"> - Audio is normal but no picture is displayed on the screen.
Major checkpoints	<ul style="list-style-type: none"> - Check the PC source - Check the Arsenal, Check the Chelsea. - This may happen when the LVDS cable connecting the Main Board and the Panel is disconnected.
Diagnostics	 <pre> graph TD Q1[Power indicator LED is off. Lamp(Backlight) on, no video?] -- No --> A1[Check a set in the 'Stand-by mode' or 'DPMS mode'.] Q1 -- Yes --> Q2[Check the PC source and check the connection of D-SUB ?] Q2 -- No --> A2[Input the analog PC signal properly.] Q2 -- Yes --> Q3[Does the signal appear at TP - PC_R, PC_G, PC_B, PC_HS, PC_VS (R, G, B, H, V) ?] Q3 -- No --> A3[Check CN902, PC cable. Change the Main Assy.] Q3 -- Yes --> Q4[Does the digital data appear at TP-E_TXCLK+, E_TXCLK-, O_TXCLK+, O_TXCLK-?] Q4 -- No --> A4[Check IC1102 (SX1). Change the Main Assy.] Q4 -- Yes --> Q5[Check the LVDS cable? Check the T-Con B'd? Replace the LCD panel?] Q5 -- No --> A5[Please, Contact Tech support.] </pre>
Caution	<p>Make sure to disconnect the power before working on the IP board.</p>

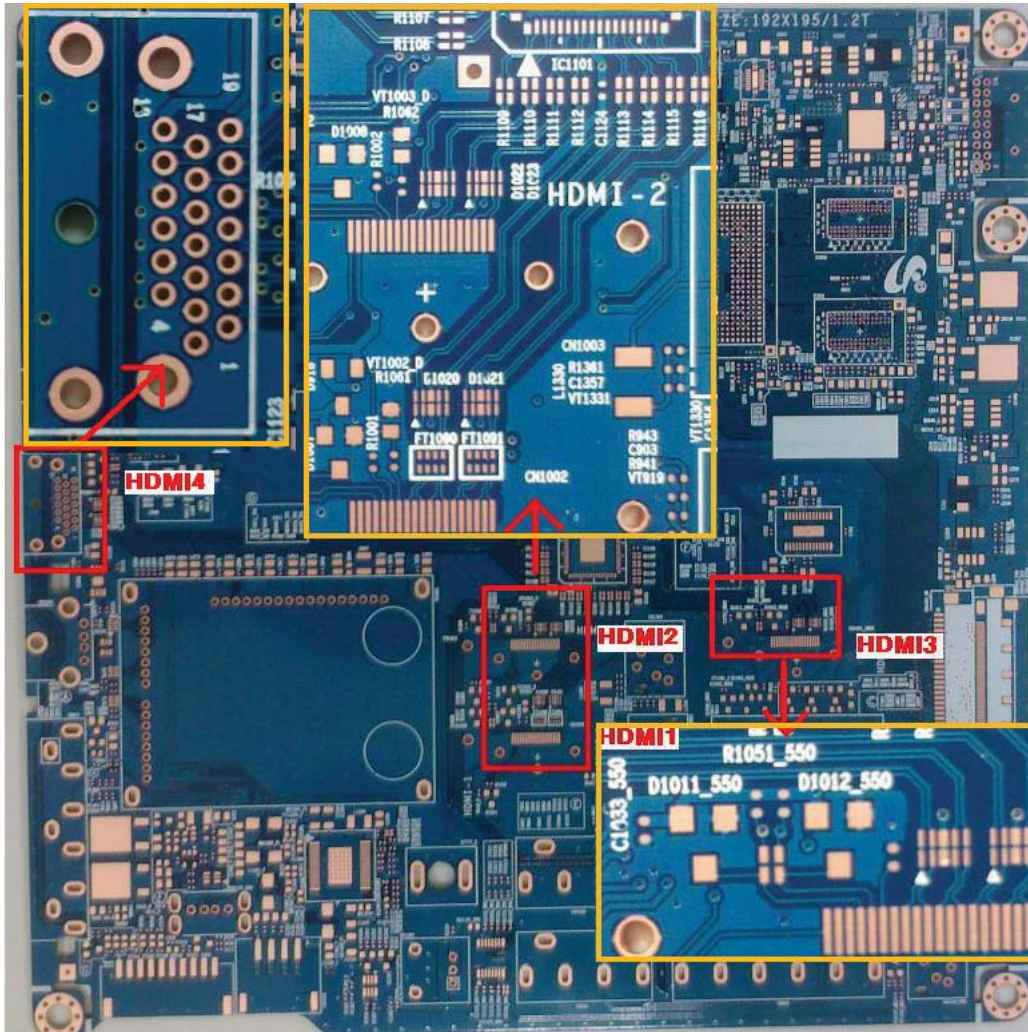

MAINBOARD(B)

WAVEFORMS

1 PC input (V-sink , H-sink , R/G/B)

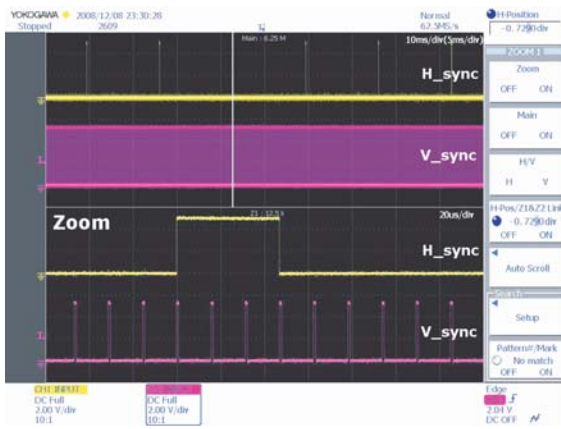

2 LVDS output

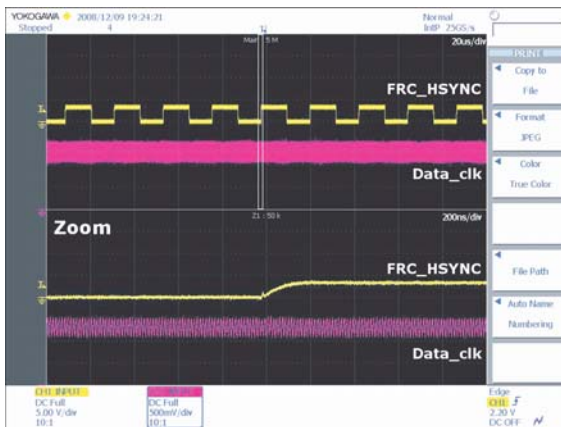

4-1-4. No video (HDMI1, 2, 3, 4 - Digital signal)

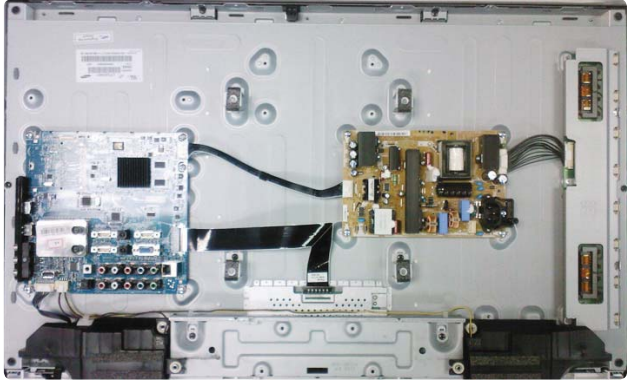
Symptom	<ul style="list-style-type: none"> - Audio is normal but no picture is displayed on the screen.
Major checkpoints	<ul style="list-style-type: none"> - Check the HDMI source. - Check the HDMI switch, Check the Chelsea. - This may happen when the LVDS cable connecting the Main Board and the Panel is disconnected.
Diagnostics	 <pre> graph TD Q1[Power indicator LED is off. Lamp(Backlight) on, no video ?] -- No --> A1[Check a set in the 'Stand-by mode'.'] Q1 -- Yes --> Q2[Check the HDMI source and check the connection of HDMI cable?] Q2 -- No --> A2[Input the HDMI signal properly.] Q2 -- Yes --> Q3[Does the signal appear at CN1002 (Pin#12 , #7)(HDMI1) CN1006 (Pin#12 , #7)(HDMI2) CN1001_550 (Pin#12 , #7)(HDMI3) CN1004 (Pin#12 , #7)(HDMI4) (HDMI RX_Clk , RX_Data) ?] Q3 -- No --> A3[Check CN1002, CN1006 CN1001_550, CN1004. Check HDMI cable. Change the Main Assy.] Q3 -- Yes --> Q4[Does the digital data appear at TP-E_TXCLK+, E_TXCLK-, O_TXCLK+, O_TXCLK-?] Q4 -- No --> A4[Check IC1102 (SX1). Change the Main Assy.] Q4 -- Yes --> Q5[Check the LVDS cable? Check the T-Con B'd? Replace the LCD panel?] Q5 -- No --> A5[Please, Contact Tech support.] </pre>
Caution	<p>Make sure to disconnect the power before working on the IP board.</p>

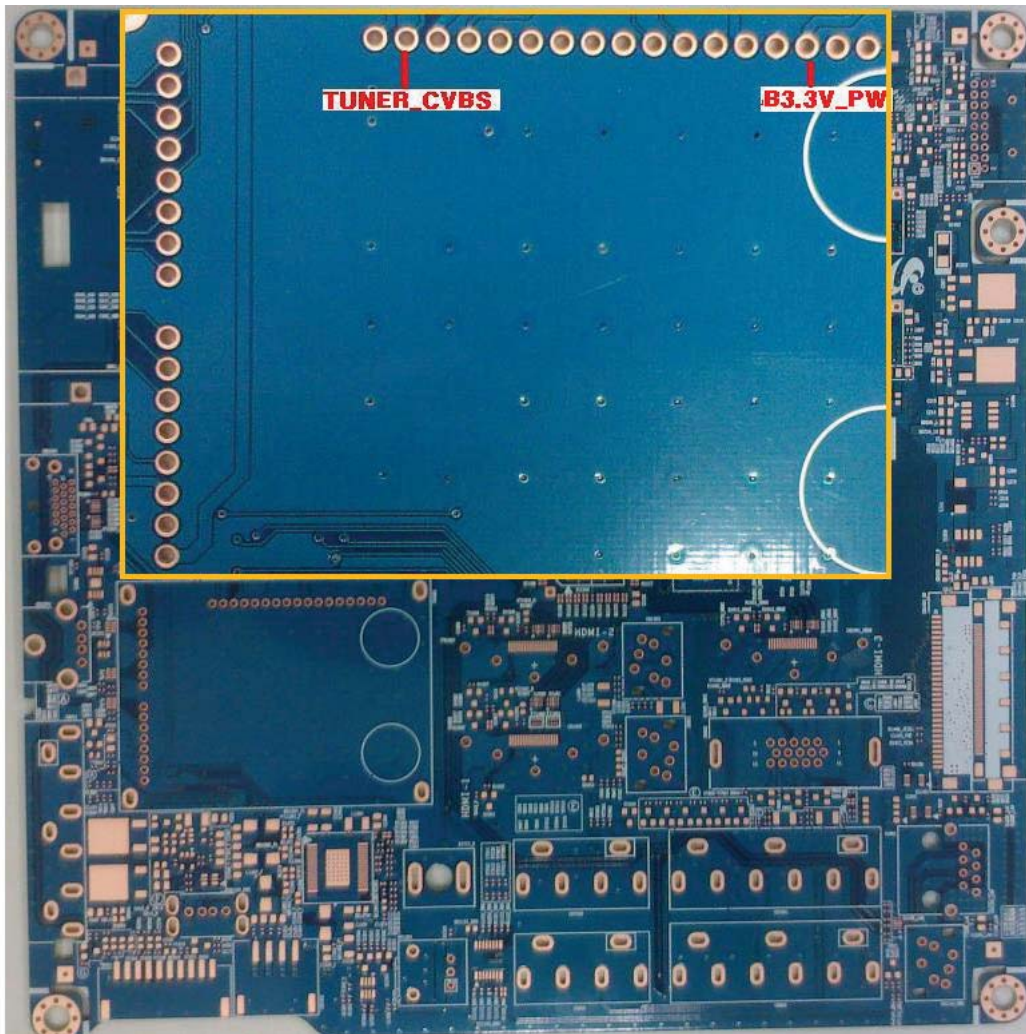

MAINBOARD(T)

WAVEFORMS

3 HDMI input (RX_Data, RX_Clk)

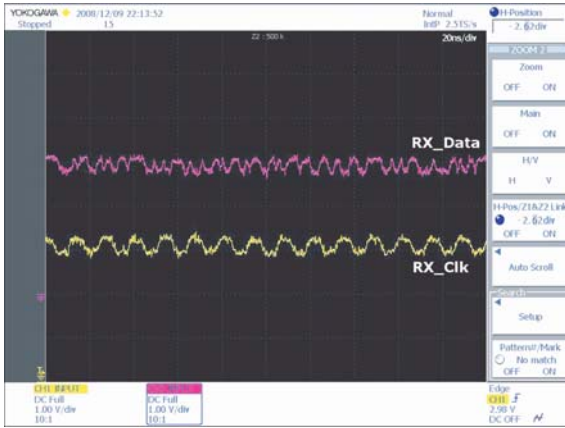

2 LVDS output

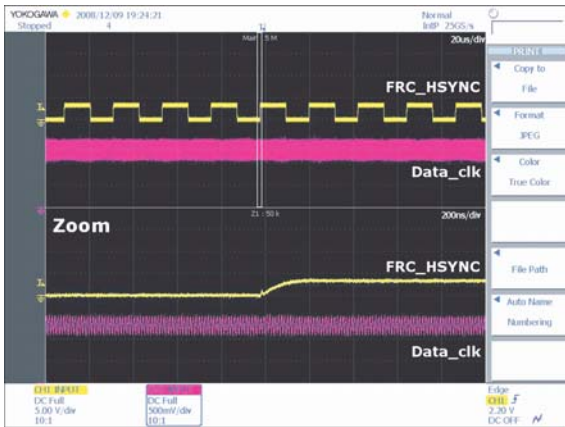

4-1-5. No Video (Tuner_CVBS)

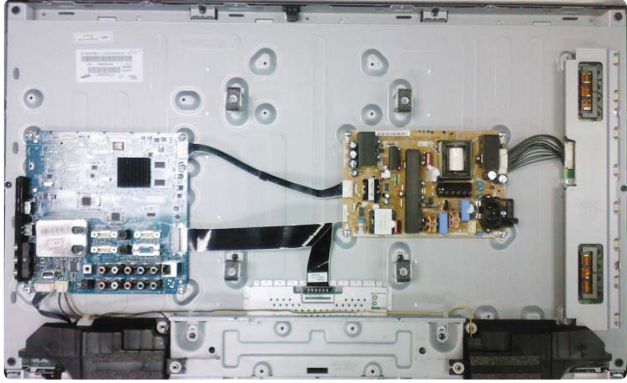
Symptom	<ul style="list-style-type: none"> - Audio is normal but no picture is displayed on the screen.
Major checkpoints	<ul style="list-style-type: none"> - Check the Tuner CVBS source. - Check the Tuner, Check the Chelsea. - This may happen when the LVDS cable connecting the Main Board and the Panel is disconnected.
Diagnostics	 <pre> graph TD Q1[Power indicator LED is off. Lamp(Backlight) on, no video ?] -- No --> A1[Check a set in the 'Stand-by mode'.'] Q1 -- Yes --> Q2[Check the RF source and check the connection of RF cable?] Q2 -- No --> A2[Input the RF source properly.] Q2 -- Yes --> Q3[Does the DC B5V_TU_PW, TU33V_PW appear at #3, #5 Pin of Tuner ?] Q3 -- No --> A3[Change the Main Assy.] Q3 -- Yes --> Q4[Does the digital data appear at TP-E_TXCLK+, E_TXCLK-, O_TXCLK+, O_TXCLK-?] Q4 -- No --> A4[Check IC1102 (SX1). Change the Main Assy.] Q4 -- Yes --> Q5[Check the LVDS cable? Check the T-Con B'd?] Q5 -- No --> A5[Please, Contact Tech support.] </pre> <p>2</p>
Caution	Make sure to disconnect the power before working on the IP board.

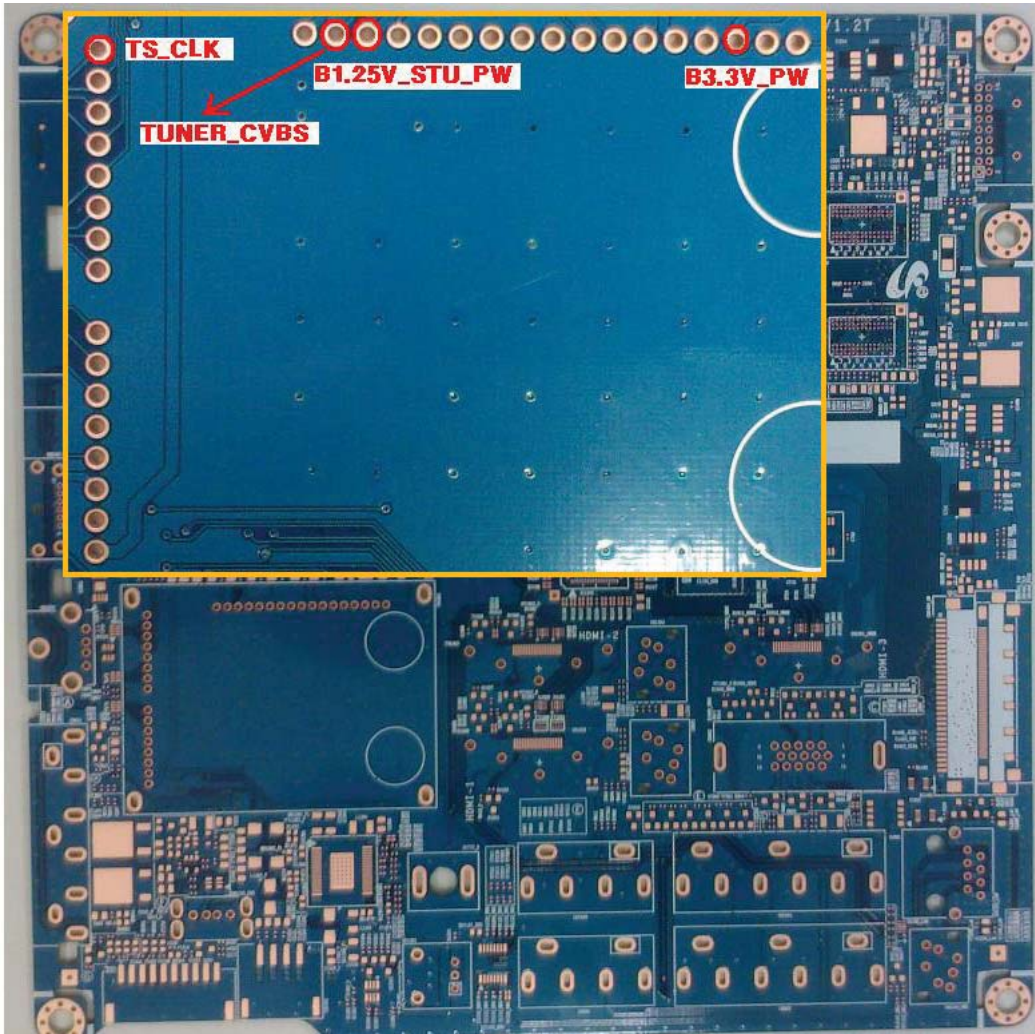

MAINBOARD(T)

WAVEFORMS

2 LVDS output

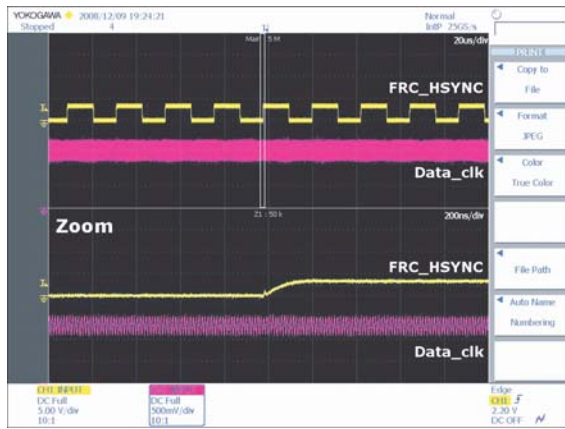

4-1-6. No Video (Tuner DTV)

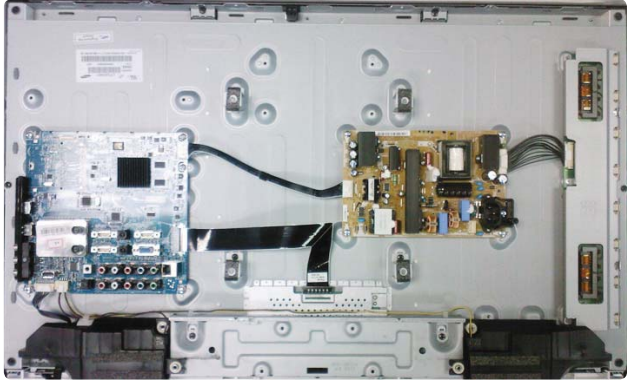
Symptom	<ul style="list-style-type: none"> - Audio is normal but no picture is displayed on the screen.
Major checkpoints	<ul style="list-style-type: none"> - Check the DTV source. - Check the Tuner, Check the Chelsea. - This may happen when the LVDS cable connecting the Main Board and the Panel is disconnected.
Diagnostics	 <pre> graph TD Q1[Power indicator LED is off. Lamp(Backlight) on, no video ?] -- No --> A1[Check a set in the 'Stand-by mode'.'] Q1 -- Yes --> Q2[Check the connection of RF cable?] Q2 -- No --> A2[Input the RF source properly.] Q2 -- Yes --> Q3[Check the 'signal strength' in Self Diagnosis menu Strength is enough?] Q3 -- No --> A3[Input the RF cable properly.] Q3 -- Yes --> Q4[Does the DC B5V_TU_PW, TU33V_PW appear at #3, #5 Pin of Tuner] Q4 -- No --> A4[Check the D-TV source.] Q4 -- Yes --> Q5[Does the digital data appear at TP-E_TXCLK+, E_TXCLK-, O_TXCLK+, O_TXCLK-?] Q5 -- No --> A5[Check IC1102 (SX1). Change the Main Assy.] Q5 -- Yes --> Q6[Check the LVDS cable? Check the T-Con B'd?] Q6 -- No --> A6[Please, Contact Tech support.] </pre>
Caution	<p>Make sure to disconnect the power before working on the IP board.</p>

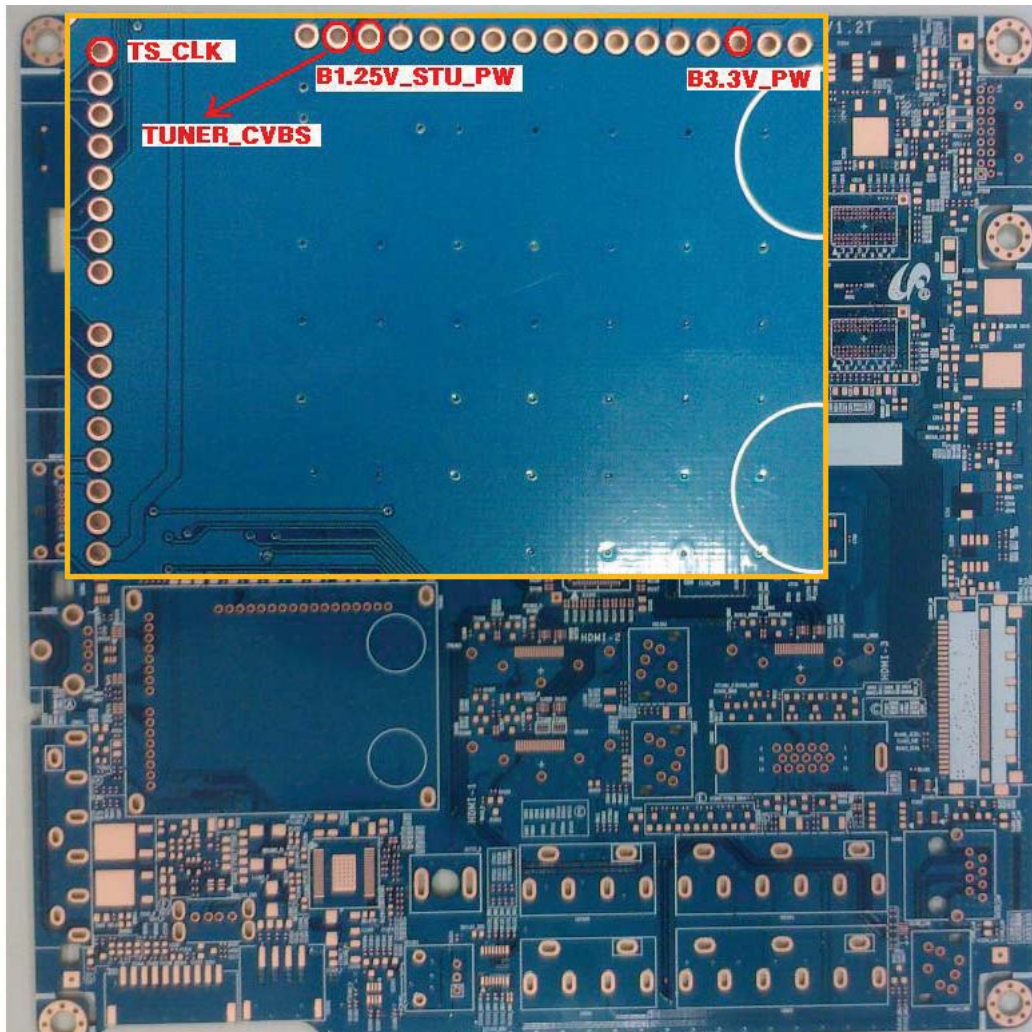

MAINBOARD(T)

WAVEFORMS

2

LVDS output

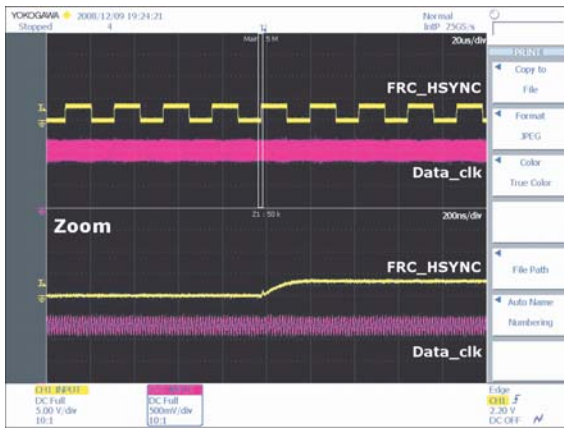

4-1-7. No Video (Video CVBS)

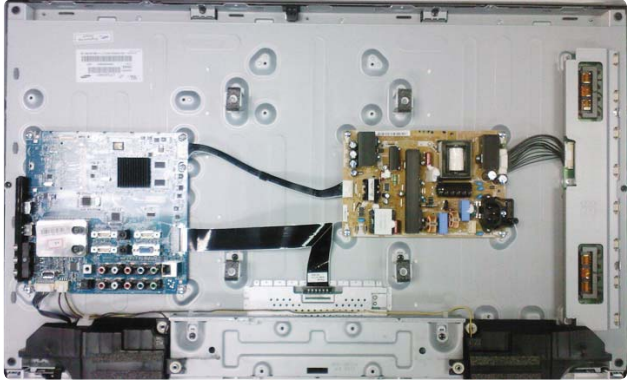
Symptom	<ul style="list-style-type: none"> - Audio is normal but no picture is displayed on the screen.
Major checkpoints	<ul style="list-style-type: none"> - Check the Video CVBS source - Check the Chelsea. - This may happen when the LVDS cable connecting the Main Board and the Panel is disconnected.
Diagnostics	 <pre> graph TD Q1[Power indicator LED is off. Lamp(Backlight) on, no video ?] -- No --> A1[Check a set in the 'Stand-by mode'.'] Q1 -- Yes --> Q2[Check the video source and check the connection of video cable?] Q2 -- No --> A2[Input the video source properly.] Q2 -- Yes --> Q3[4 Does the CVBS data appear at TP - AV_CVBS?] Q3 -- No --> A3[Check CN801. Change the Main Assy.] Q3 -- Yes --> Q4[2 Does the digital data appear at TP-E_TXCLK+, E_TXCLK-, O_TXCLK+, O_TXCLK-?] Q4 -- No --> A4[Check IC1102 (SX1). Change the Main Assy.] Q4 -- Yes --> Q5[Check the LVDS cable? Check the T-Con B'd? Replace the LCD panel?] Q5 -- No --> A5[Please, Contact Tech support.] </pre>
Caution	<p>Make sure to disconnect the power before working on the IP board.</p>

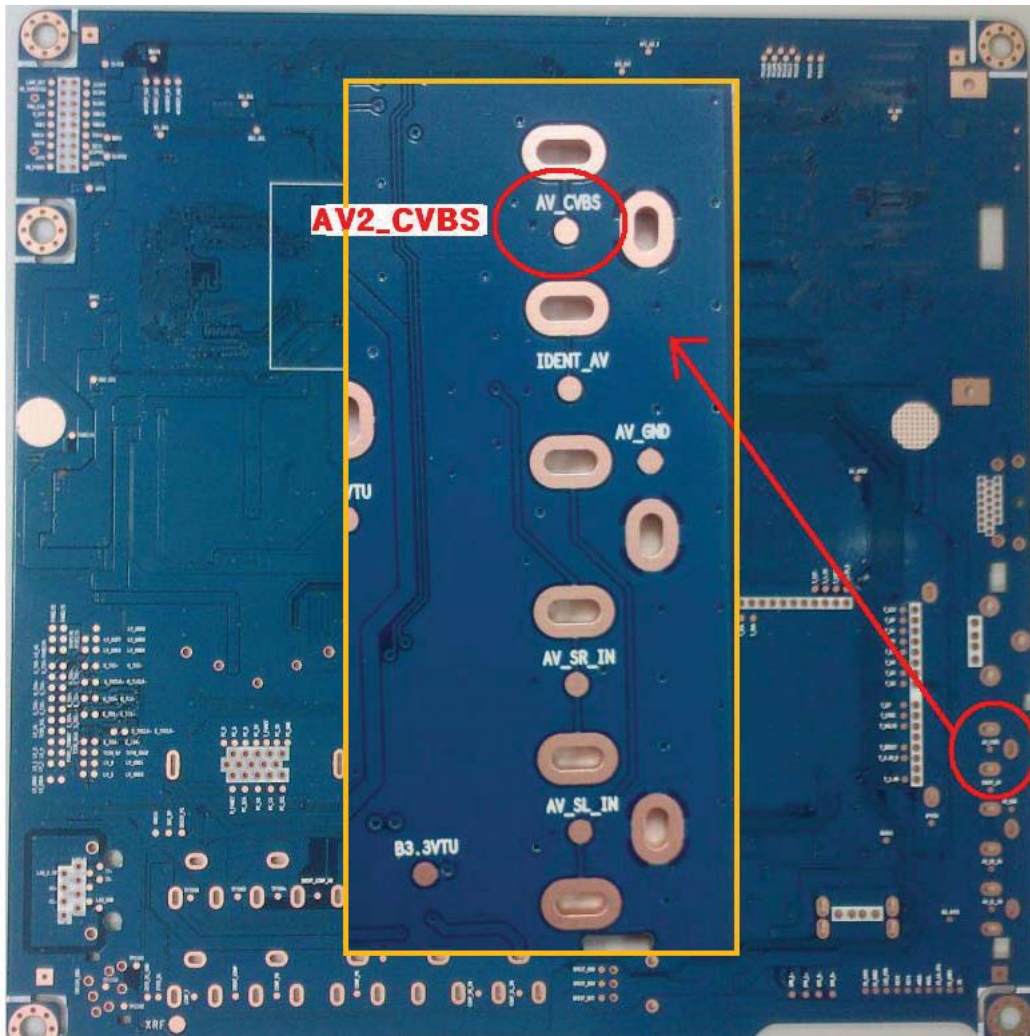

MAINBOARD(B)

WAVEFORMS

4 CVBS OUT (Grey Bar)

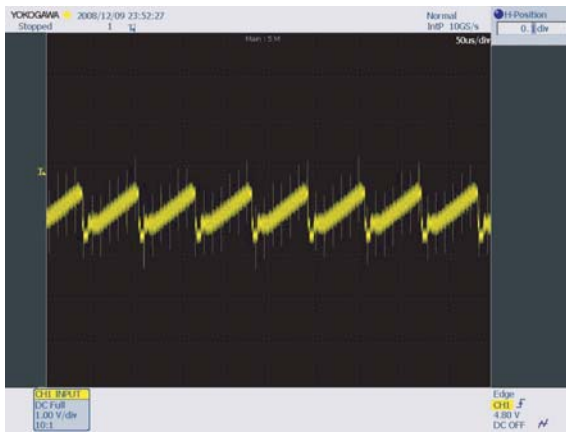

2 LVDS output

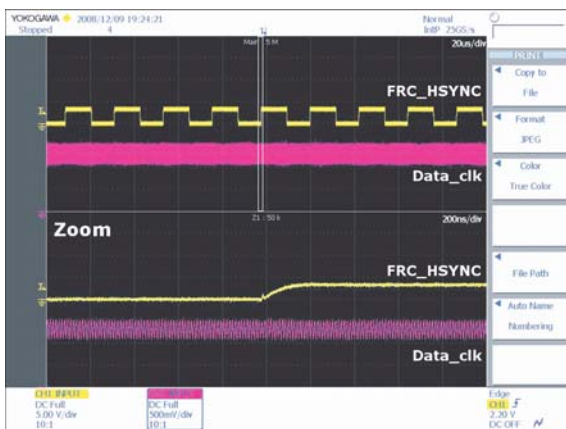

4-1-8. No Video (Component)

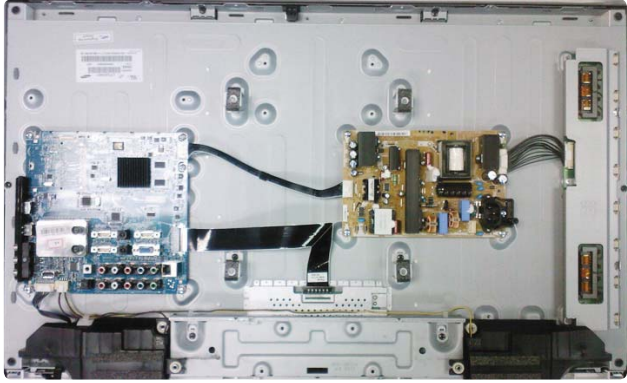
Symptom	<ul style="list-style-type: none"> - Audio is normal but no picture is displayed on the screen.
Major checkpoints	<ul style="list-style-type: none"> - Check the Component source - Check the chelsea. - This may happen when the LVDS cable connecting the Main Board and the Panel is disconnected.
Diagnostics	 <pre> graph TD Q1[Power indicator LED is off. Lamp(Backlight) on, no video ?] -- No --> A1[Check a set in the 'Stand-by mode'.'] Q1 -- Yes --> Q2[Check the component source and check the connection of component cables(Y,Pb,Pr)?] Q2 -- No --> A2[Input the component source properly.] Q2 -- Yes --> Q3[5 Does the component data appear at TP - COMP_Y, COMP_PB, COMP_PR?] Q3 -- No --> A3[Check CN802. Change the Main Assy.] Q3 -- Yes --> Q4[2 Does the digital data appear at TP-E_TXCLK+, E_TXCLK- , O_TXCLK+, O_TXCLK-?] Q4 -- No --> A4[Check IC1102 (SX1). Change the Main Assy.] Q4 -- Yes --> Q5[Check the LVDS cable? Check the T-Con B'd? Replace the LCD panel?] Q5 -- No --> A5[Please, Contact Tech support.] </pre>
Caution	<p>Make sure to disconnect the power before working on the IP board.</p>

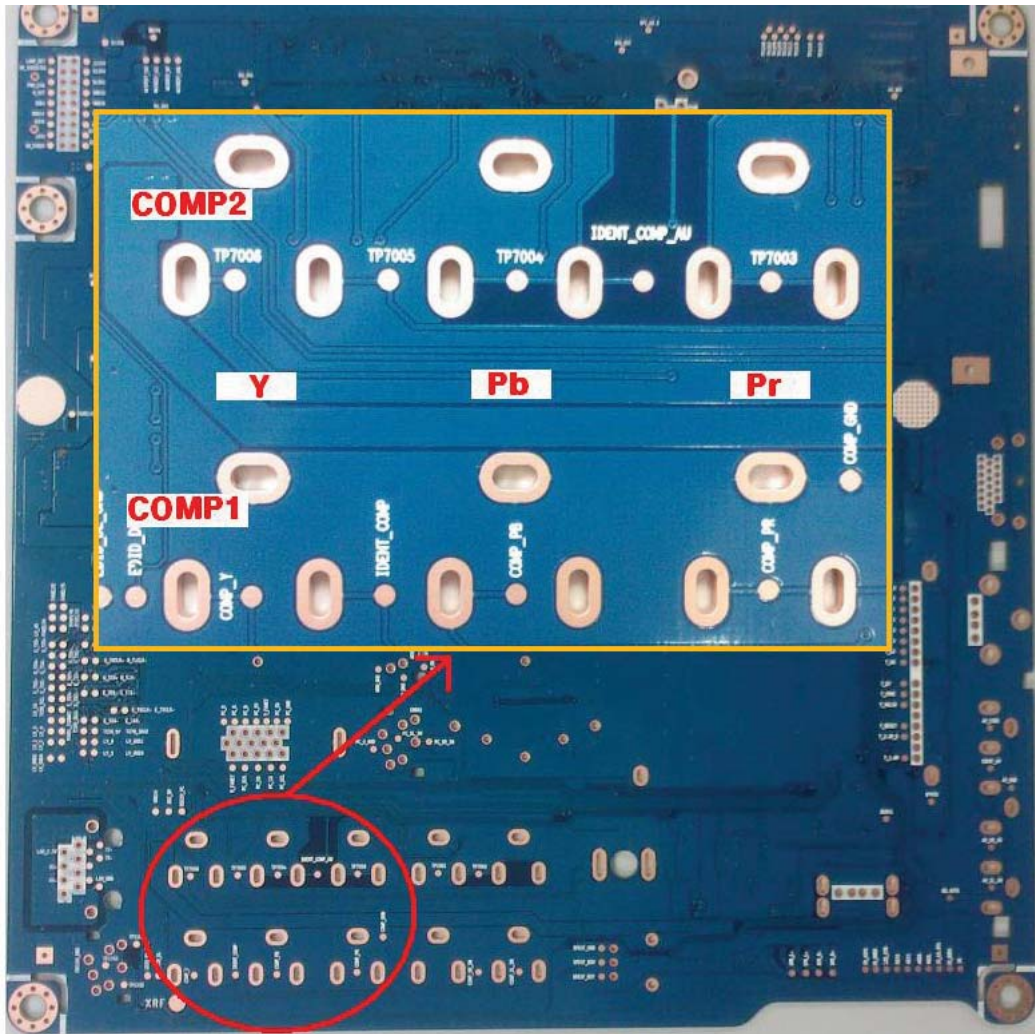

MAINBOARD(B)

WAVEFORMS

5 **Compnent_Y (Gray scale) / Pb / Pr (Color bar)**

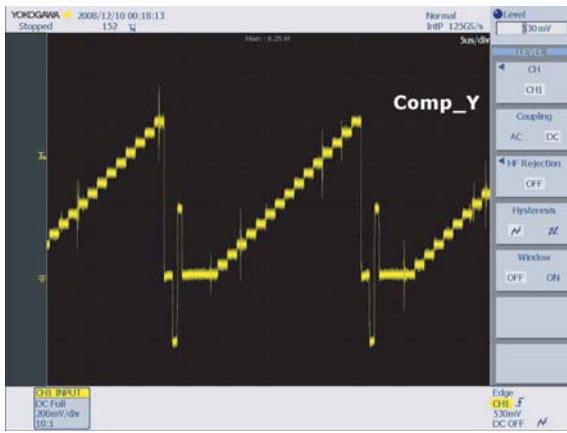

2 **LVDS output**

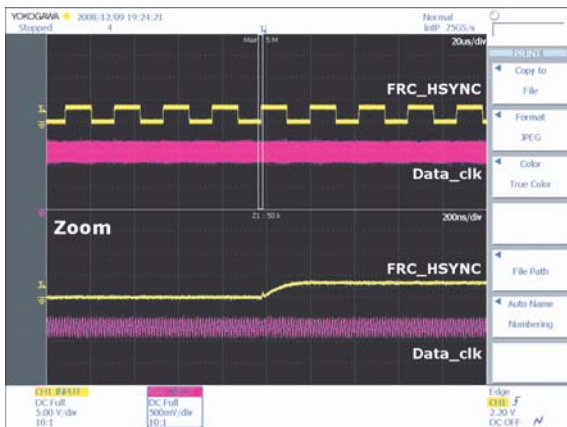

4-1-9. No Sound

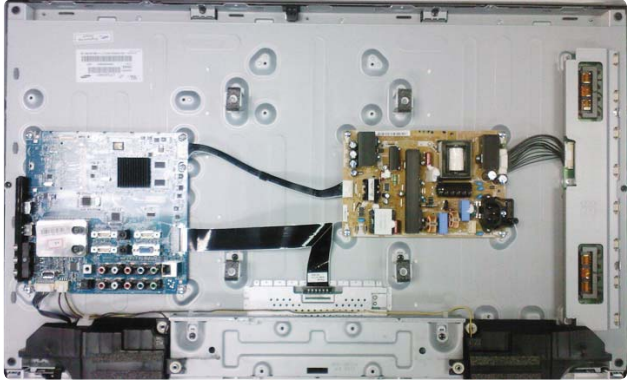
Symptom	<ul style="list-style-type: none"> - Video is normal but there is no sound..
Major checkpoints	<ul style="list-style-type: none"> - When the speaker connectors are disconnected or damaged. - When the sound processing part of the Main Board is not functioning. - Speaker defect..
Diagnostics	 <pre> graph TD Q1[Check the source and check the connection of sound cable? (Comp/AV/PC/DVI to HDMI)] -- No --> A1[Input the sound source properly.] Q1 -- Yes --> Q2[Does the sound data appear at TP - COMP_SL_IN, COMP_SR_IN (COMP) TP - AV_SL_IN, AV_SR_IN (AV) TP - PC_SL_IN, PC_SR_IN (PC/DVI) ?] Q2 -- No --> A2[Check CN802, CN801, CN901. Change the Main Assy.] Q2 -- Yes --> Q3[Does the DC B12VS appear at TP - B12VS1?] Q3 -- No --> A3[Change the Main Assy.] Q3 -- Yes --> Q4[Does the sound data appear at TP - SPK_L-, SPK_L+, SPK_R-, SPK_R+?] Q4 -- No --> A4[Check I102 (SX1). Check IC1301 (Sound AMP).] Q4 -- Yes --> Q5[Replace speaker.] Q5 -- No --> A5[Please, Contact Tech support.] </pre>
Caution	<p>Make sure to disconnect the power before working on the IP board.</p>

WAVEFORMS

6 Speaker out

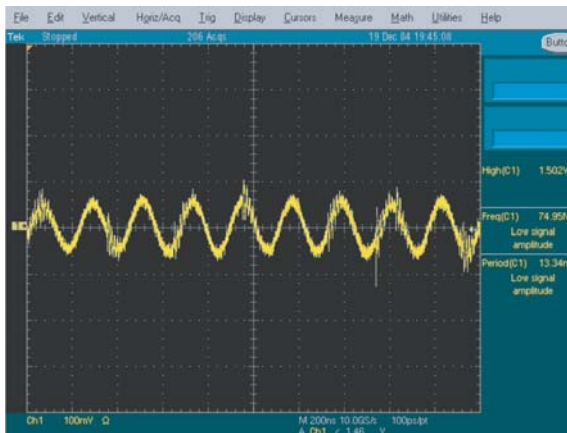

4-2. Alignments and Adjustments

4-2-1. General Alignment Instruction

1. Usually, a color LCD-TV needs only slight touch-up adjustment upon installation.
Check the basic characteristics such as height, horizontal and vertical sync.
2. Use the specified test equipment or its equivalent.
3. Correct impedance matching is essential.
4. Avoid overload. Excessive signal from a sweep generator might overload the front-end of the TV. When inserting signal markers, do not allow the marker generator to distort test result.
5. Connect the TV only to an AC power source with voltage and frequency as specified on the backcover nameplate.
6. Do not attempt to connect or disconnect any wire while the TV is turned on. Make sure that the power cord is disconnected before replacing any parts.
7. To protect against shock hazard, use an isolation transformer.

4-3. Factory Mode Adjustments

4-3-1 Entering Factory Mode

To enter 'Service Mode' Press the remote -control keys in this sequence :

- If you do not have Factory remote - control



4-3-2 How to Access Service Mode

Using the Customer Remote

1. Turn the power off and set to stand-by mode.
2. Press the remote buttons in this order; POWER OFF- INFO - MENU - MUTE to turn the set on.
3. The set turns on and enters service mode. This may take approximately 20 seconds.
4. Press the Power button to exit and store data in memory.
 - If you fail to enter service mode, repeat steps 1 and 2 above.
5. Initial SERVICE MODE DISPLAY State

Option
Control
SVC
Expert
ADC/WB
Advanced
T-TDT5DCNC-XXXX T-TDT5DCNS-XXXX EDID SUCCESS CABLIB : AV X COMP X PC X HDMI X Option : XXXX XXXX XXX
SDAL-XXXX RFS : P0220 T-TDT5DCNC 2010-01-31 Type : 32A1AFOC Model : LA32C550 MAC SUCCESS Factory Data Ver : XXX EERC Version : XXX DTP-AP-COMP-XXX DIP-HIG-XXXX DTP-BP-XXXX-XX Date of purchase : XX/XX/XXXX

* How to enter the hidden factory mode.

- a. into the factory mode
 - b. move the tap to Advanced
 - c. key input : 0 + 0 + 0 + 0
- ** hidden menu : Advanced

6. Buttons operations withn Service Mode

Menu	Full Menu Display/Move to Parent Menu
Direction Keys ▲/▼	Item Selection by Moving the Cursor
Direction Keys ◀/▶	Data Increase / Decrease for the Selected Item
Source	Cycles through the active input source that are connected to the unit

4-3-3 Factory Data

■ Option

OPTION	Factory Name	Data	Range
	Factory Reset		
	Type		NONE/19O6TH0C/19A6TH0C/22I6TH0C/22A6TH0C/22D6TH0C/22P6TH0C/26A6AH0C/26D6AH0C/26L6AH0C/26P6AH0C/32A6AH0C/32D6AH0C/32L6AH0C/32P6AH0C/32A6AF0C/32L6AF0C/32A1AF0C/32L1AF0C/37L6AF0C/37L1AF0C/40A6AF0C/40D6AF0C/40L6AF0C/40A1AF0C/40L1AF0C/40A1UF0C/40D1UF0C/40L1UF0C/46A6AF0C/46D6AF0C/46L6AF0C/46A1AF0C/46L1AF0C/46A1UF0C/46D1UF0C/46L1UF0C/55A1UF0C/55L1UF0C/65L1UF0C/19O6TH0E/22D6TH0E/26D6AH0E/32D6AH0E/32D6UF0E/32A1UF0E/32D1UF0E/37L6UF0E/37D1UF0E/37L1UF0E/40D6UF0E/40A1UF0E/40D1UF0E/46D6UF0E/46L6UF0E/46A1UF0E/46D1UF0E/46L1UF0E/55A1UF0E/55D1UF0E/55L1UF0E/65L1UF0E/42HHcD3/50HHcD4/50FArN4/50FArV4/58FArN1/58FArV1/63FArN1/
	Local Set		...
	Model	LC550	LC350/LC450/LC450H/LC451/LC452/LC457H/LC459H/LC480/LC530/LC530H/LC539H/LC540/LC550/LC570/LC560/LC580/LC610/LC620/LC630/LC631/LC632/LC633/LC640/LC650/LC652/LC653/LC654/LC670/UC4000/UC4000H/UC4010/UC5000/UC5100/UC6000/UC6200/UC6300/UC6400/UC6400H/UC6500/UC6510/UC6530/UC6540/UC6550/UC6600/UC6620/UC6630/UC6700/UC6730/UC6740/UC6800/UC6830/UC6900/UC6900H/UC8000/PC420/PC430/PC431/PC432/PC450/PC451/PC480/PC520/PC530/PC531/PC540/PC541/PC550/PC551/PC560/PC580/PC590/PC670/PC6100/PC6400/PC6500/PC7000/PC7700/PC8000
	TUNER	HummerH3	SEMPT082/SEMPA081/HummerH3/Error
	DDR	0	
	Light Effect	OFF	OFF/ON
	Ch Table	TTSEC	NONE/PBA/TTSEC
	Country		...
	Front Color		NONE/W-MILKY/T-M-Brn/T-W-Brn/T-W-Gray/W-D-Gray/W-M-Whit/W-Violet/T-C-Gray/T-R-BLK/S-BLK/S-RBLK/S-C-Gray/

■ Control

Control	Factory Name	Data	Range
	EDID		
	Sub Option		
	PDP Option		
	Hotel Option		
	Shop Option		
	Asia Option		
	Sound		
	Config Option		
	SCC		

EDID	Factory Name	Data	Range
	EDID ON/OFF	Off	
	EDID WRITE ALL	...	
	EDID WRITE PC	...	
	EDID WRITE HDMI	...	
	EDID WRITE HDMI1	...	
	EDID WRITE HDMI2	...	
	EDID WRITE HDMI3	...	
	EDID WRITE HDMI4	...	
	EDID 1.2 PORT	...	
	EDID WRITE DVI	...	

Sub Option	Factory Name	Data	Range
	RF Mute Time	600ms	0ms~1000ms
	RS-232 Jack	Debug	Debug/Login/UART
	Watchdog	OFF	ON/OFF
	WD Count	0	255
	Dimm Type	EXT	fixed
	Lvds Format	JEIDA	JEIDA/VESA/19INCH
	Language_Arabic	...	
	TOOLS Support	61	
	LNA Support	1	0/1
	MediaPlayer DB	On whth 5MB	fixed
	MediaPlayer Movie	chapterinMedia	fixed
	MediaPlayer DLNA	ON	fixed
	MediaPlayer PlayList	OFF	fixed
	NETWORK Support	Wireless	Cable/Wireless
	Info Link Server Type	operating	operation/development/developing
	Info Link Country	None	China/Hongkong
	TTX List	Flof	Flof/List
	TTX Group	UserOSD	WestEurope/EastEurope/Russian/Greek/Turkey/Arabic/Farsian/Arab/Hbrw/UserOSD
	24Px4 Support	OFF	ON/OFF
	Power Indicator Support	OFF	ON/OFF
	BD Wise Support	OFF	ON/OFF
	Data Service Support	OFF	ON/OFF
	OTA Duration Test	OFF	ON/OFF
	Alternate Del	OFF	ON/OFF

4. Troubleshooting

OTN Server Type	operating	operation/development
OTN Test Server	OFF	OFF/ A/B/C/D/E Zone
OTN Support	ON	ON/OFF
OTN Reset		not modified
OTN Duration	OFF	ON/OFF
OTN Fail Test	OFF	ON/OFF
IIC Bus Stop	OFF	ON/OFF
Visual Test	Disable	fixed
T-CON USB Download	Failure	fixed
Emergency Log Copy		
Checksum	0x0000	
View Log		not modified
ColorSpace Support	HueSat Type	RGB Type/HueSat Type
Gemstar On/Off	OFF	ON/OFF
WSS Support	ON	ON/OFF
PVR Support	OFF	ON/OFF
CI Support	ON	ON/OFF
Eeprom Reset		
Spread Spectrum		
DDR Margin		
SST		not modified
SST_Th		
2nd mips	ON	ON/OFF
2nd mips count	0	0~255
Region	CHI	CHI/HKG
PnP Language	CHI	Error/KOR/ENG_US/SAP_US/FRA_US/POR_US/BUL/CRO/CZE/DAN/DUT/FIN/FRA/DEU/GRE/HUN/ITA/NOR/ENG/POL/POR/ROM/RUS/SER/SLK/SPA/SWE/TUR/CHI/HKG/TPE/JPN/MAO/CMN/YUE/HIN/EST/LAT/LTU/ARA/PER/OAA/AD/CAT/VAL/THA/HEB/IND/VIE/URD/AFR/ZUL/XHO/YOR/IGB/HAU/SWA/AMH/TAM/OTHER
PC Auto Ident	Enable	Auto/Enable

PDP Option	Factory Name	Data	Range
	...		

Hotel Option	Factory Name	Data	Range
	Hotel Mode	OFF	
	SI Vender	...	
	Power On Channel	...	
	Channel Type	...	
	Power On Volume	...	
	Min Volume	...	
	Max Volume	...	
	Panel Button Lock	...	
	Power On Source	...	

Shop Option	Factory Name	Data	Range
	Shop Mode	OFF	ON/OFF
	Exhibition Mode	OFF	ON/OFF

Asia Option	Factory Name	Data	Range
	TTX	OFF	ON/OFF
	China HD	OFF	ON/OFF
	NT Conversion	OFF	ON/OFF
	Sepco 120Hz	OFF	ON/OFF
	Unbalance	OFF	ON/OFF
	FMTransmitter Support	OFF	ON/OFF
	FMTRransmitter Carrier	OFF	ON/OFF
	AF Level adjust	3	0~7
	TX Power Level	0	
	Mono Last Memory	OFF	ON/OFF

Sound	Factory Name	Data	Range
	High Devi	OFF	ON/OFF
	Carrier_Mute	OFF	ON/OFF
	Volume Cruve	Type2	Type1/Type2/Error
	Speaker Delay Normal	10	0~255
	Pilot Level High Thld	0x70h	0x00~0xff
	Pilot Level Low Thld	0x20h	0x00~0xff
	FM Prescale	16	0~255
	AM Prescale	10	0~255
	NICAM Prescale	33	0~255
	Amp Volume	0x3bh	0x00~0xff
	Amp Scale	0x78h	0x00~0xff

4. Troubleshooting

Amp Check Sum	0x00434F05	
Woofer Type	1	1~7
Woofer Scale	0x0h	0x00~0xff
Woofer Check Sum		
Speaker EQ	ON	ON/OFF
PEQ Test	0	0~5
Amp Model	STA369B	STA369B/TAS5715/NTP7300
Speaker cut-off Freq	4	0~16
SPDIF PCM Gain	-9dB	-10dB~0dB

Config Option	Factory Name	Data	Range
	Num of ATV	1	0~2
	Num of DTV	1	0~2
	Num of AV	2	0~3
	Num of SVIDEO	0	0~3
	Num of COMP	2	0~3
	Num of HDMI	4	0~4
	Num of PC	1	0~1
	Num of SCART	0	0~2
	Num of DVI	0	0~1
	Num of OPTICAL Link	1	0
	Num of MEDIA	1	0~1
	Num of PANEL KEY	6	0~8
	Num of USB Port	2	1~2
	Num of HeadPhone	0	0~1
	MFT Offset	62.5	62.5/50
	Select LCD/PDP	LCD	LCD/PDP
	HDMI/DVI SEL	1	1~4
	Indicator Led	OFF	ON/OFF
	Wall Mount	OFF	ON/OFF
	HV Flip	ON	ON/OFF
	Num of Display	2	1~2
	DVI/HDMI SOUND	Auto	Auto/DVI
	HDMI HOT PLUG	Disable	Enable/Disable
	HOTPLUG SWITCHING	Boot	Boot/Source
	HOT PLUG DURATION	1200ms	0~2000ms
	CLK TERM DURATION	1200ms	2000ms
	HDMI FLT CNT SIG	200ms	0~1000ms
	HDMI FLT CNT LOS	600ms	0~1000ms
	UNSTABLE BAN CNT	3500ms	0~10000ms
	HDMI Err Cnt	5	0~10

	HDMI ROBIN	ON	ON/OFF
	HDMI Callback	OFF	ON/OFF
	HDMI CTS Thld	8	0~15
	HDMI CTS Cnt1	1	0~15
	TMDS_EQ2_Boost	1	0~7
	TMDS_EQ2_Gain	0	0~3
	TMDS_PLL_Loop	3	0~3
	TMDS_CPREG_BLEED	1	0~1
	HDMI EQ	AUTO	AUTO/LOW/MIDDLE/HIGH/STRONG
	HDMI Write Type	Combine	Combine/Separate
	HDMI Switch	SIL9287	NONE/SIL9287/TMDS461
	DVI SET TIME	300ms	0~1000ms
	Type Of PANEL KEY	Horizontal	Horizontal/Vertical
	EcoSensor Support	ON	ON/OFF
	LEDMotionPlus Support	OFF	ON/OFF
	Natural Mode Support	ON	ON/OFF
	All Share Support	OFF	ON/OFF
	Relax Mode Support	OFF	ON/OFF
	DVI-I Support	OFF	ON/OFF
	Melfas Frction Support	OFF	ON/OFF
	Light Level Support	OFF	ON/OFF
SCC	Factory Name	Data	Range
	SCC Mode	Dynamic	Movie/Dynamic
	SCC ON/OFF	OFF	ON/OFF
	SCC Input Data		
	sSCC Const		
	pSCC Const		
	SCC Source Data	PBA	PBA/PANEL
	SWAP	PBA	PBA/PANEL

■ SVC

SVC	Factory Name	Data	Range
	Test Pattern		fixed
	Panel Auto Setting	Success	
	Panel Display Time	7Hr	
	Logic Usb D/L	off	
	Tuner Status		

Test Pattern	Factory Name	Data	Range
	Pattern Sel	OFF	OFF/ White/Grey/Black/Red/Green/Blue
	FRC PC Mode	...	ON/OFF
	Logic Pattern Sel	...	Not modified
	Logic Level Sel	...	Not modified

TUNER STATUS	Factory Name	Factory Name	Range
	DVB	SNR	0
		BER	0
		Singal Strength	0
		Bandwidth	8MHz
		Frequency	87.250000MH
		LNA Status	OFF
		FFT	0x0
		Modulation	32QAM
		Code Rate	0.4
		GI	None
		Hier Modulation	Non-Hier
		Frequency Offset	2000.00Hz
		Timing Offset	0.00ppm
		AGC	3641
		UCB	0
		PLL Type	TDA6651
		DEMOD Type	SCORPIUS
		TPS LOCK	Unlock
		RS Lock	Unlock
		SSI	
SQI			

ISDB-T	FFT Size_1	Not modified
	Guard Interval_1	Not modified
	Freq. Offset_1	Not modified
	SNR_1	Not modified
	IF AGC_1	Not modified
	TMCC Lock_1	Not modified
	TS Packet_1	Not modified
	Master Lock_1	Not modified
	A_Modulation_1	Not modified
	A_Code Rate_1	Not modified
	A_Timer InterLeave_1	Not modified
	A_Segments Num_1	Not modified
	A_Ber_1	Not modified
	B_Modulation_1	Not modified
	B_Code Rate_1	Not modified
	B_Timer InterLeave_1	Not modified
	B_Segments Num_1	Not modified
	B_BER_1	Not modified
	C_Modulation_1	Not modified
	C_Code Rate_1	Not modified
	C_Timer InterLeave_1	Not modified
	C_Segments Num_1	Not modified
	C_BER_1	Not modified

■ Expert

Expert	Factory Name	Data	Range
	N / D ADJ	Off	Off / On / FIX
	SOURCE	...	Not modified

■ ADC/WB

ADC/WB	Factory Name	Data	Range
	ADC		
	ADC Target		
	ADC RESULT		
	White Balance		

ADC	Factory Name	Data	Range
	AV Calibration	Success	Success / Failure
	Comp Calibration	Success	Success / Failure
	PC Calibration	Success	Success / Failure
	HDMI Calibration	Success	Success / Failure

ADC Target	Factory Name	Data	Range
	1st_AV_Low	64	0~255
	1st_AV_High	880	0~1020
	1st_AV_Delta	2	0~255
	1st_COMP_Y_Low	64	0~1020
	1st_COMP_Cb_Low	...	
	1st_COMP_Cr_Low	...	
	1st_COMP_Y_High	940	0~1020
	1st_COMP_Cb_High	...	
	1st_COMP_Cr_High	...	
	1st_COMP_Delta	2	0~7
	1st_PC_R_Low	16	0~1020
	1st_PC_G_Low	...	
	1st_PC_B_Low	...	
	1st_PC_R_High	1004	0~1020
	1st_PC_G_High	...	
	1st_PC_B_High	...	
	1st_PC_Delta	2	0~7
	2nd_AV_R_Low	4	0~124
	2nd_AV_G_Low	4	0~124
	2nd_AV_B_Low	4	0~124
	2nd_AV_R_High	940	0~1020
	2nd_AV_G_High	940	0~1020
	2nd_AV_B_High	940	0~1020
	2nd_AV_Detal	2	0~7
	2nd_Comp_R_Low	4	fixed
	2nd_Comp_G_Low	4	0~124

2nd_Comp_B_Low	4	0~124
2nd_Comp_R_High	940	0~1020
2nd_Comp_G_High	940	0~1020
2nd_Comp_B_High	940	0~1020
2nd_Comp_Delta	2	0~7
2nd_PC_R_Low	4	fixed
2nd_PC_G_Low	4	0~124
2nd_PC_B_Low	4	0~124
2nd_PC_R_High	940	0~1020
2nd_PC_G_High	940	0~1020
2nd_PC_B_High	940	0~1020
2nd_PC_Delta	2	0~7
2nd_HDMI_R_Low	4	fixed
2nd_HDMI_G_Low	4	0~124
2nd_HDMI_B_Low	4	0~124
2nd_HDMI_R_High	940	0~1020
2nd_HDMI_G_High	940	0~1020
2nd_HDMI_B_High	940	0~1020
2nd_HDMI_Delta	2	0~7

ADC RESULT	Factory Name	Data	Range
	1st_Y_GH	128	0~255
	1st_Y_GL	32	0~255
	1st_Cb_BH	0	
	1st_Cb_BL	0	
	1st_Cr_RH	0	
	1st_Cr_RL	0	
	2nd_R_L	132	0~255
	2nd_G_L	132	0~255
	2nd_B_L	132	0~255
	2nd_R_H	50	0~255
	2nd_G_H	50	0~255
	2nd_B_H	50	0~255

4. Troubleshooting

WB	Factory Name	Data	Range
	Sub Brightness	128	0~255
	R_Offset	512	0~1023
	G_Offset	512	0~1023
	B_Offset	512	0~1023
	Sub	Contrast	128
	R_Gain	512	0~1023
	G_Gain	512	0~1023
	B_Gain	512	0~1023
	Movie R-Offset	...	
	Movie B-Offset	...	
	Movie R-Gain	...	
	Movie B-Gain	...	

4-4. White Balance - Calibration

4-4-1 White Balance -Calibration

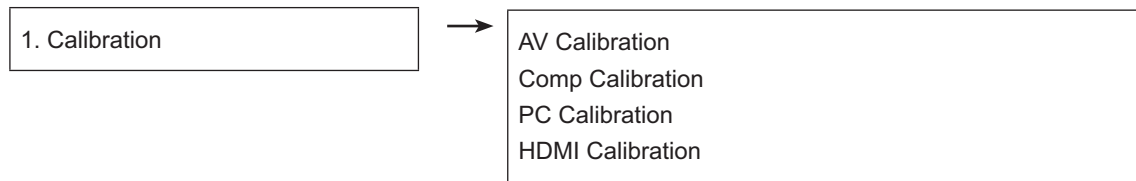

4-4-2 White Balance - Adjustment

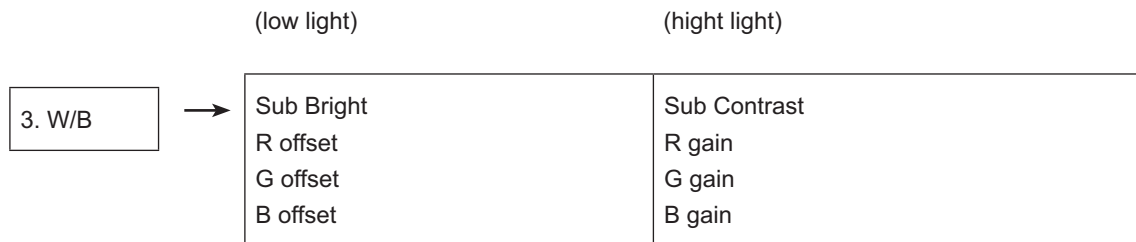

(W/B adjustment Condition refer next page)

4-5. White Ratio (Balance) Adjustment

- You can adjust the white ratio in factory mode (1:Calibration, 3:White-Balance).
- Since the adjustment value and the data value vary depending on the input source, you have to adjust these in CVBS, Component 1 and HDMI 1 modes.
- The optimal values for each mode are configured by default. (Refer to Table 1, 2)
It varies with Panel's size and Specification.
 - Equipment : CS-210
 - Pattern: MIK K-7256 #92 "Flat W/B Pattern" as standard
 - Use other equipment only after comparing the result with that of the Master equipment.
 - Set Aging time : 60min ↑
 - Calibration and Manual setting for WB adjustment.

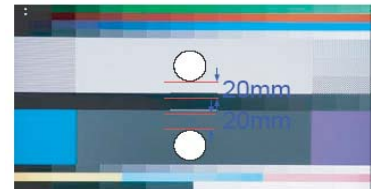

- | | | |
|--|---|---|
| HDMI : Calibration at #24 Chessboard Pattern | → | Manual adjustment #92 pattern (720p) |
| COMP: Calibration at #24 Chessboard Pattern | → | Manual adjustment at #92 pattern (720p) |
| CVBS: Calibration at #24 Chessboard Pattern | → | Manual adjustment at #92 pattern (PAL) |

- If finishing in HDMI mode, adjustment coordinate is almost same in AV/COMP mode.
- White Balance Manual Adjustment

P-Mode	Adjustment Coordinate				
		x	y	Y (Luminance)	T(K) + MPCD
CVBS (PAL)	H/L	272	278	- (Sub_CT:130)	12,000 (±0)
	L/L	272	278	12.6cd/m ² (3.7 Ft)	12,000 (±0)
COMP (720P)	H/L	272	278	- (Sub_CT:130)	12,000 (±0)
	L/L	272	278	13.0cd/m ² (3.8 Ft)	12,000 (±0)
HDMI (720P)	H/L	272	278	- (Sub_CT:130)	12,000 (±0)
	L/L	272	278	13.0cd/m ² (3.8 Ft)	12,000 (±0)

- Adjustment Specification

- White Balance : High light (±1), Low light (±3)
- Luminance : High light (Don't care), Low light (±0.2 Ft/L)

4-6. Servicing Information

4-6-1 USB Download Method

Samsung may offer upgrades for TV's firmware in the future. Please contact the Samsung call center at 1-800-SAMSUNG (726-7864) to receive information about downloading upgrades and using a USB drive. Upgrades will be possible by connecting a USB drive to the USB port located on your TV.

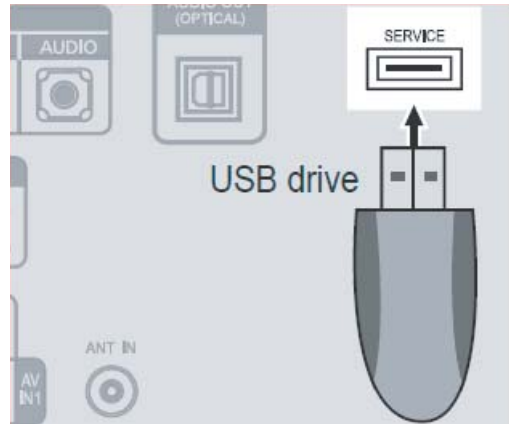

1. Insert a USB drive containing the firmware upgrade into the USB port on the rear of the TV.
2. Press the **MENU** button to display the menu. Press the ▲ or ▼ button to select "Support", then press the **ENTER** button.
3. Press the ▲ or ▼ button to select "SW Upgrade", then press the **ENTER** button. The message "Scanning for USB. It may take up to 30 seconds." is displayed.
4. The message "Upgrade version XXXX to version XXXX? The system will be reset after upgrade." is displayed. Press the ◀ or ▶ to select the "OK", then press the **ENTER** button.

Please be careful to not disconnect the power or remove the USB drive while upgrades are being applied. The TV will turn off and turn on automatically after completing the firmware upgrade. Please check the firmware version after the upgrades are complete. When software is upgraded, video and audio settings you have made will return to their default (factory) settings. We recommend you write down your settings so that you can easily reset them after the upgrade.

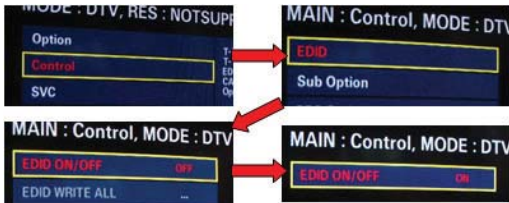

4-7. How To Upgrade Sub Micom With Ddc Manager

4-7-1. TV Sub S/W

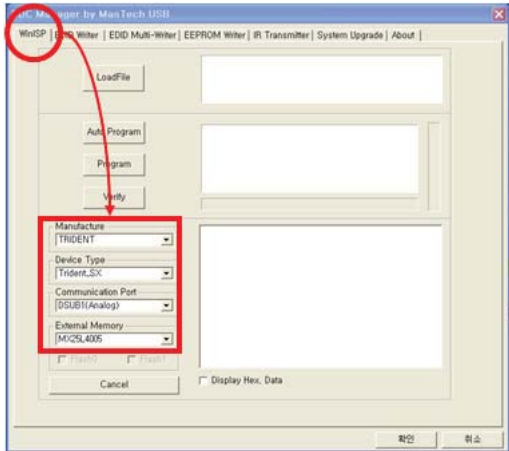
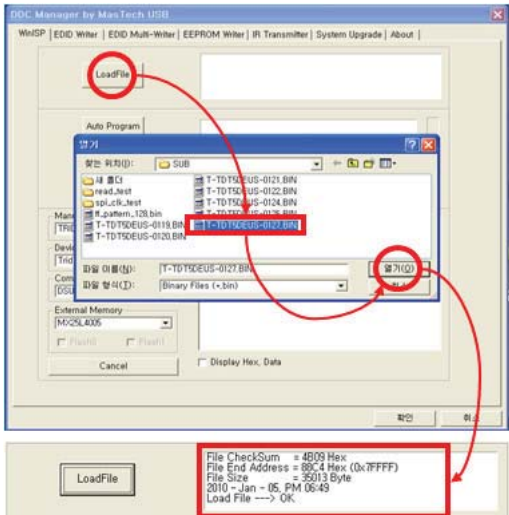
Order	Description	
1	Connect DDC MANAGER to the TV Set with D-SUB cable. And Power on.	
2	Enter the factory mode. Control - EDID - EDID ON/OFF Select ON.	
3	Open the DDC tool. (Parallel type & USB type)  Check the setting.	
4	Load the sub micom program file.	

4. Troubleshooting

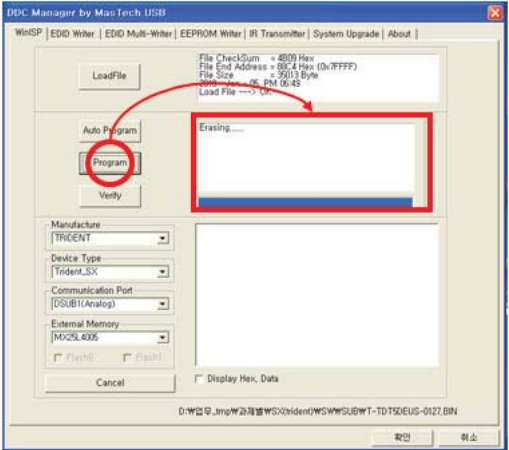
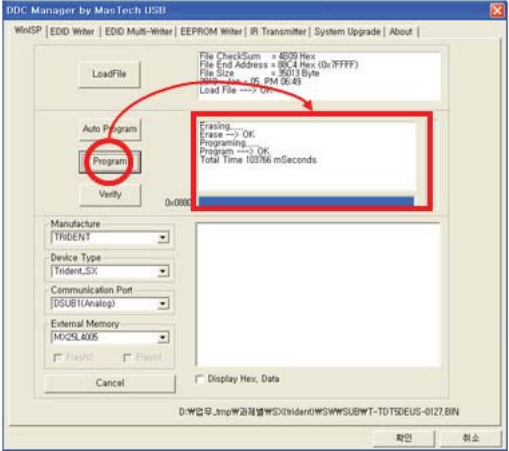
Order	Description	
5	<p>Push the 'Program' Button. (It takes quite a bit of time. You can wait or close the DDC tool by force and open tool and load file again.)</p>	 <p>The screenshot shows the 'DDC Manager by Mac Tech USB' interface. The 'Program' button is circled in red. A red box highlights the 'Erasing...' progress bar. The status window shows 'Erasing...' and 'Load File -> OK'.</p>
6	<p>Push the 'Program' Button again. (It takes about 100 seconds.)</p>	 <p>The screenshot shows the 'DDC Manager by Mac Tech USB' interface. The 'Program' button is circled in red. A red box highlights the 'Erasing...' progress bar. The status window shows 'Erasing... OK', 'Programming... OK', and 'Total Time 103/106 mSeconds'.</p>
7	<p>If update completes, TV set will booting automatically. Disconnect the JIG.</p>	

4-8. Mechanical diagram

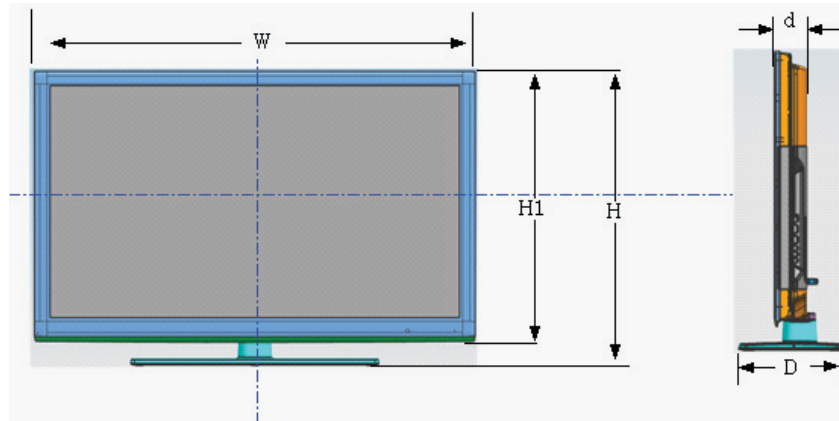

		LC530 32"	LC530 37"	LC530 40"	LC530 46"
Size [mm]	Set with Stand (W * D * H)	783.0*220.2*536.2	901.8*240.0*613.6	970.0*240.0*651.7	1102.4*260.1*733.2
	Set without Stand (W * d * H1)	783.0*76.2*497.5	901.8*76.9*561.8	970.0*78.6*600.1	1102.4*78.7*676.3
Weight [Kg]	Set with Stand	10.76	14.24	17.3	20.64
	Set without Stand	8.76	11.34	14.4	16.74

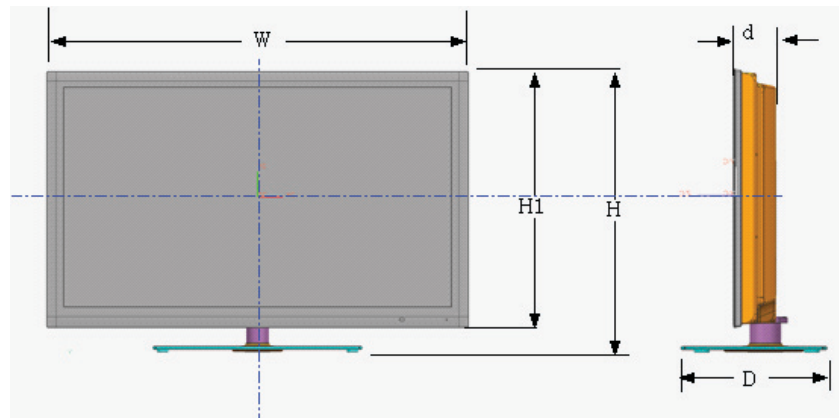

		LC550 32"	LC550 37"	LC550 40"	LC550 46"
Size [mm]	Set with Stand (W * D * H)	793.7*239*557.5	911.6*255*622.8	980.2*255*660.9	1305.9*305*847.1
	Set without Stand (W * d * H1)	793.7*78*494.3	911.6*78.2*559.4	1112.5*80.3*672.5	1305.9*85.3*783.8
Weight [Kg]	Set with Stand	11.5	14.9	18.2	21.7
	Set without Stand	8.8	11.5	14.8	17.9

4-9. PCB diagram

4-9-1. PCB layout

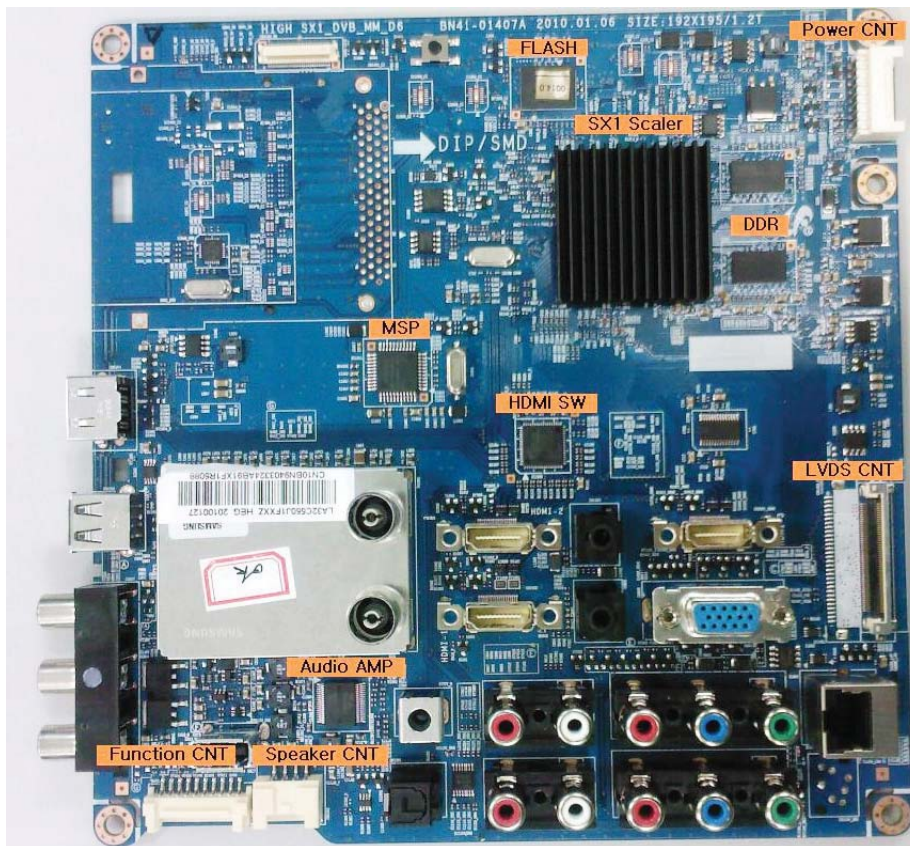

4-9-2. Main TOP

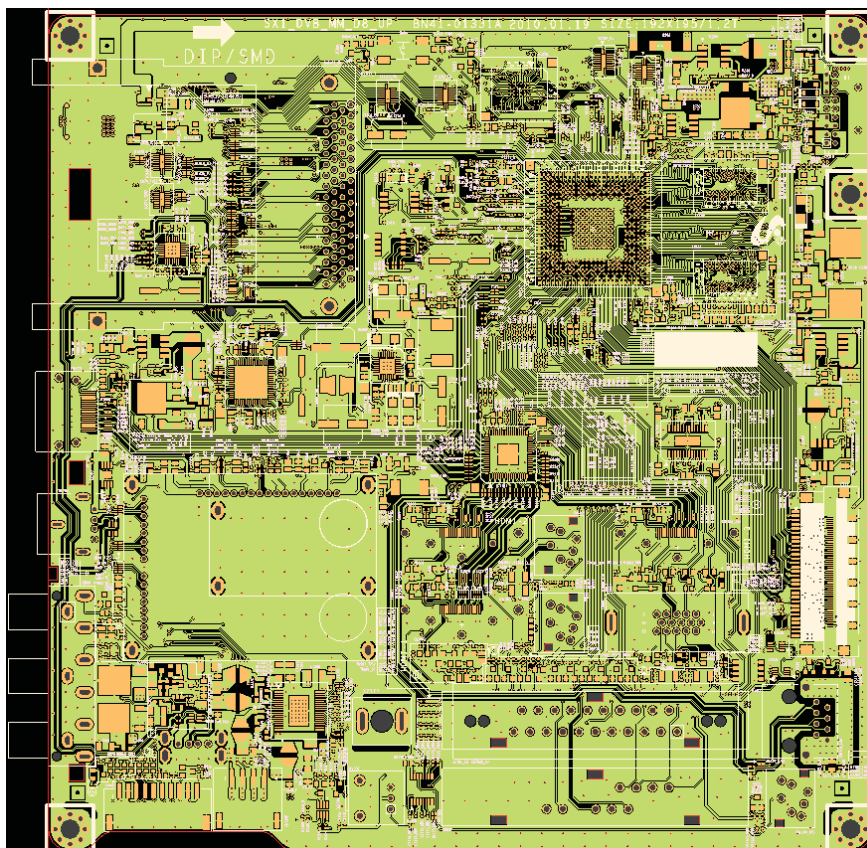

4-9-3. Main Inner(2)

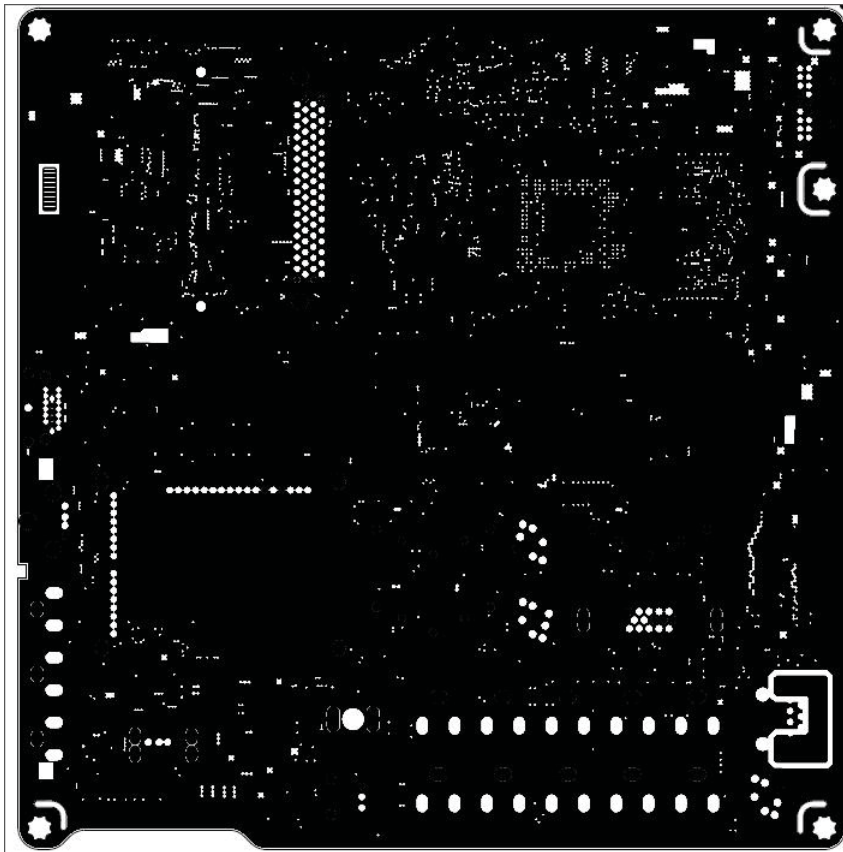

4-9-4. Main Inner(3)

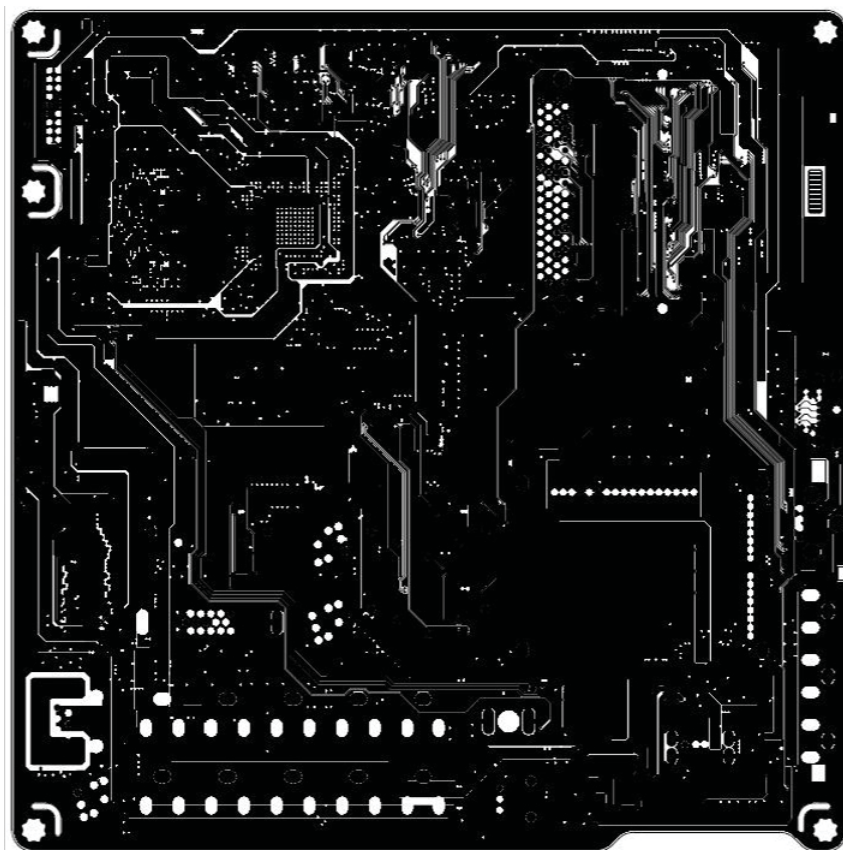

4-9-5. Main Bottom

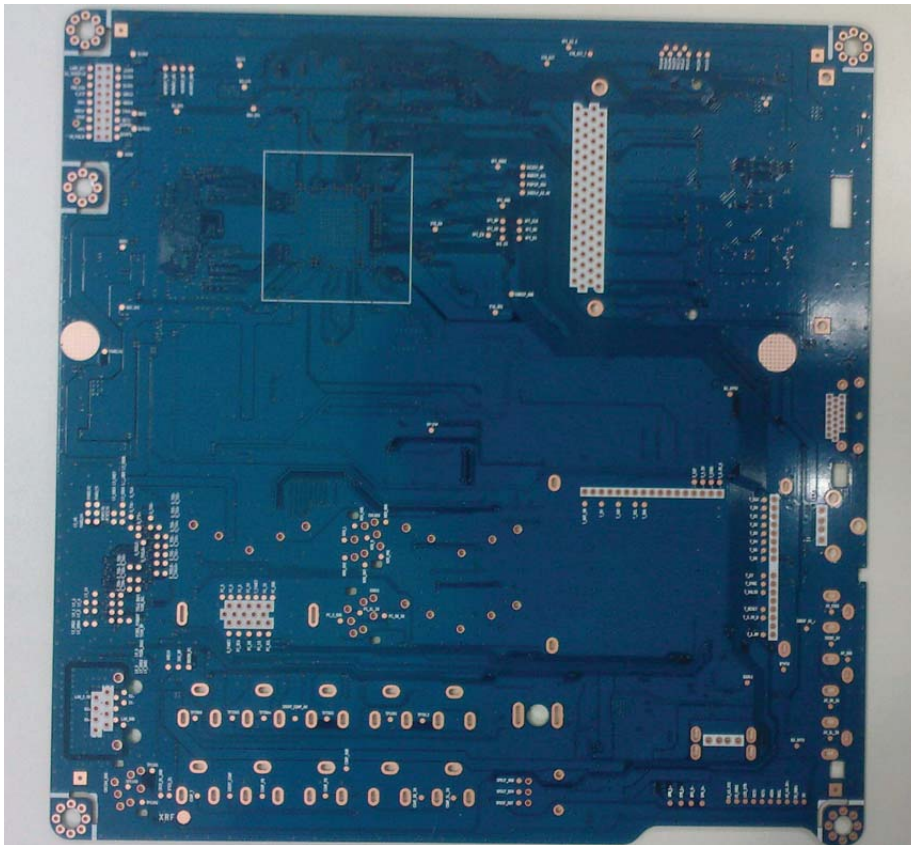

4-9-6. Power_32" SMPS

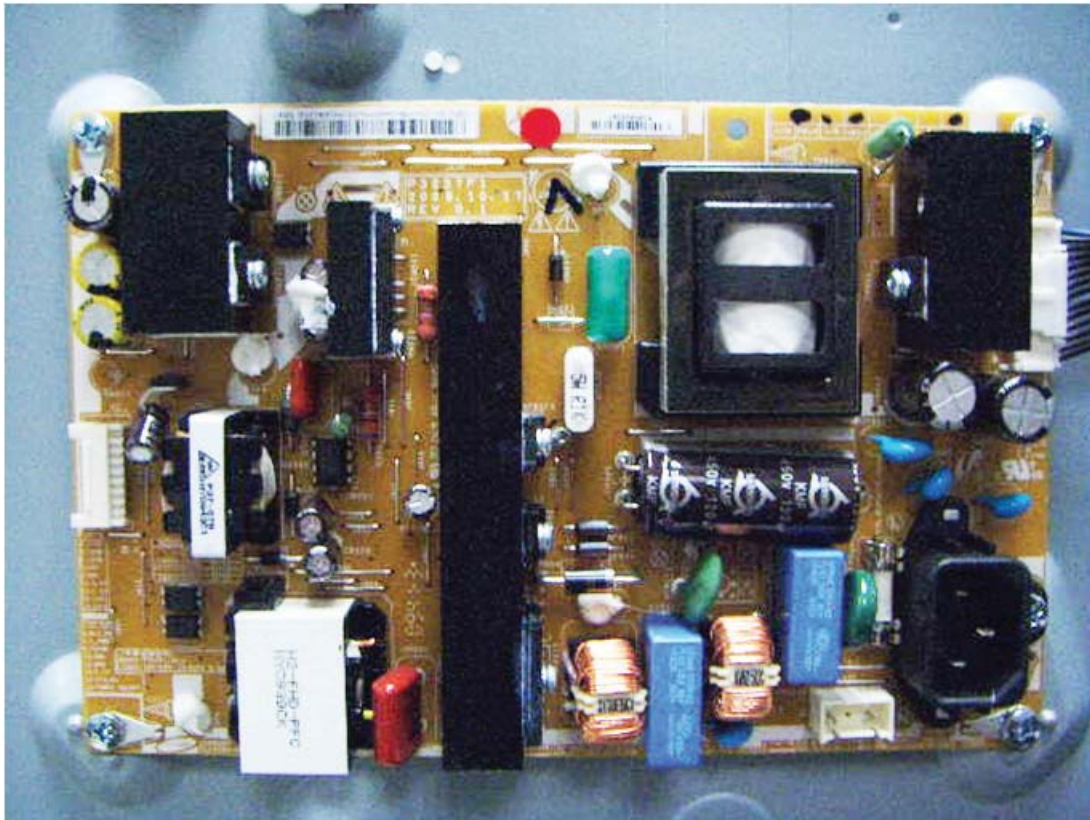

4-9-7. Power_37" SMPS

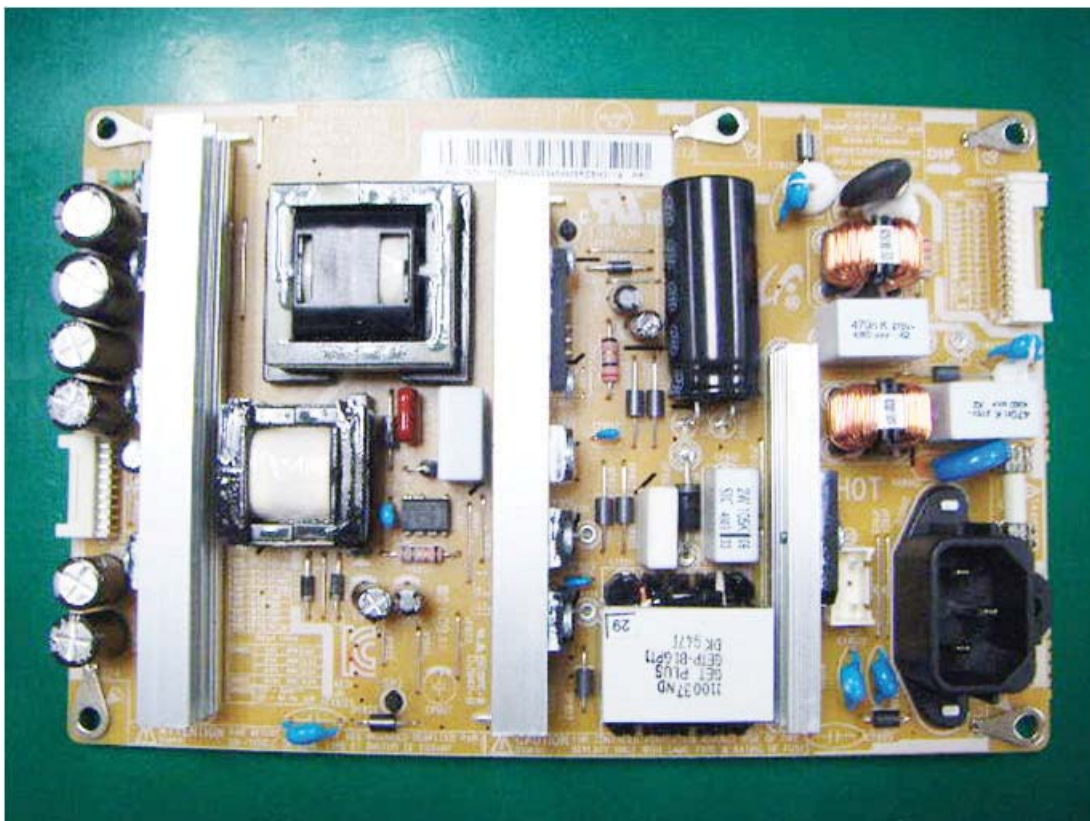

4-9-8. Power_40" SMPS

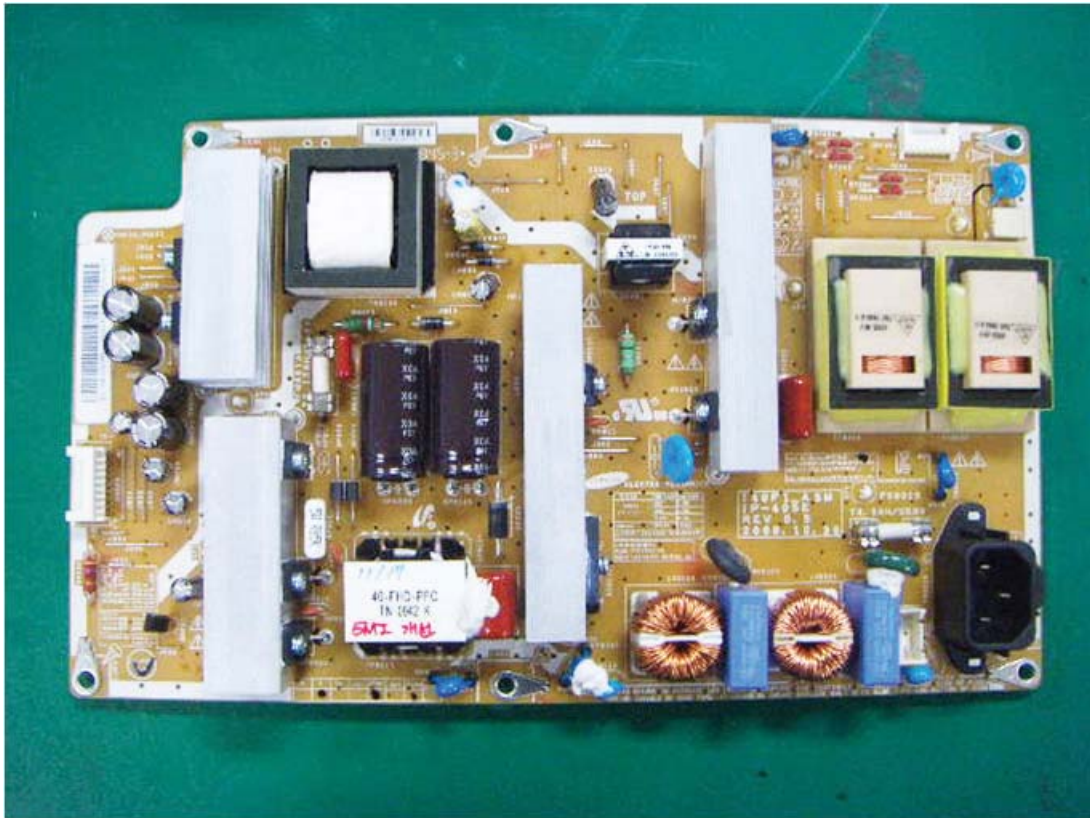

4-9-9. Power_46" SMPS

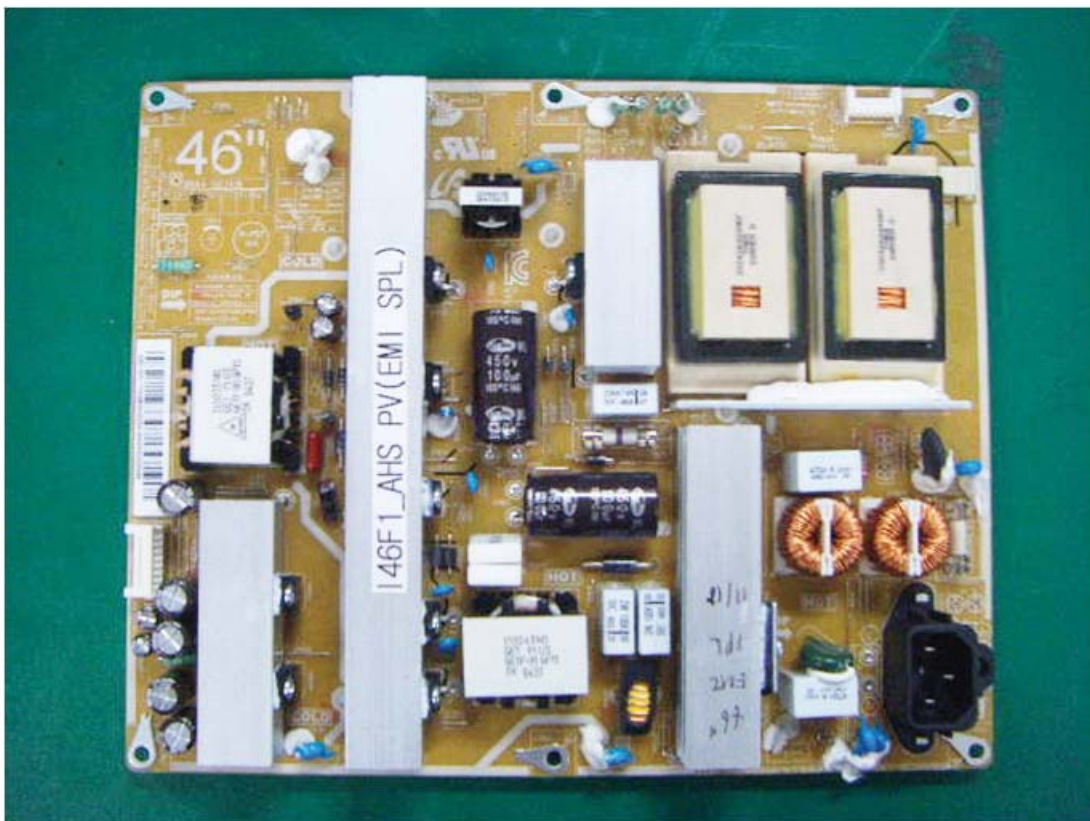

6. Wiring Diagram

6-1. Wiring Diagram

■ 32" _37"

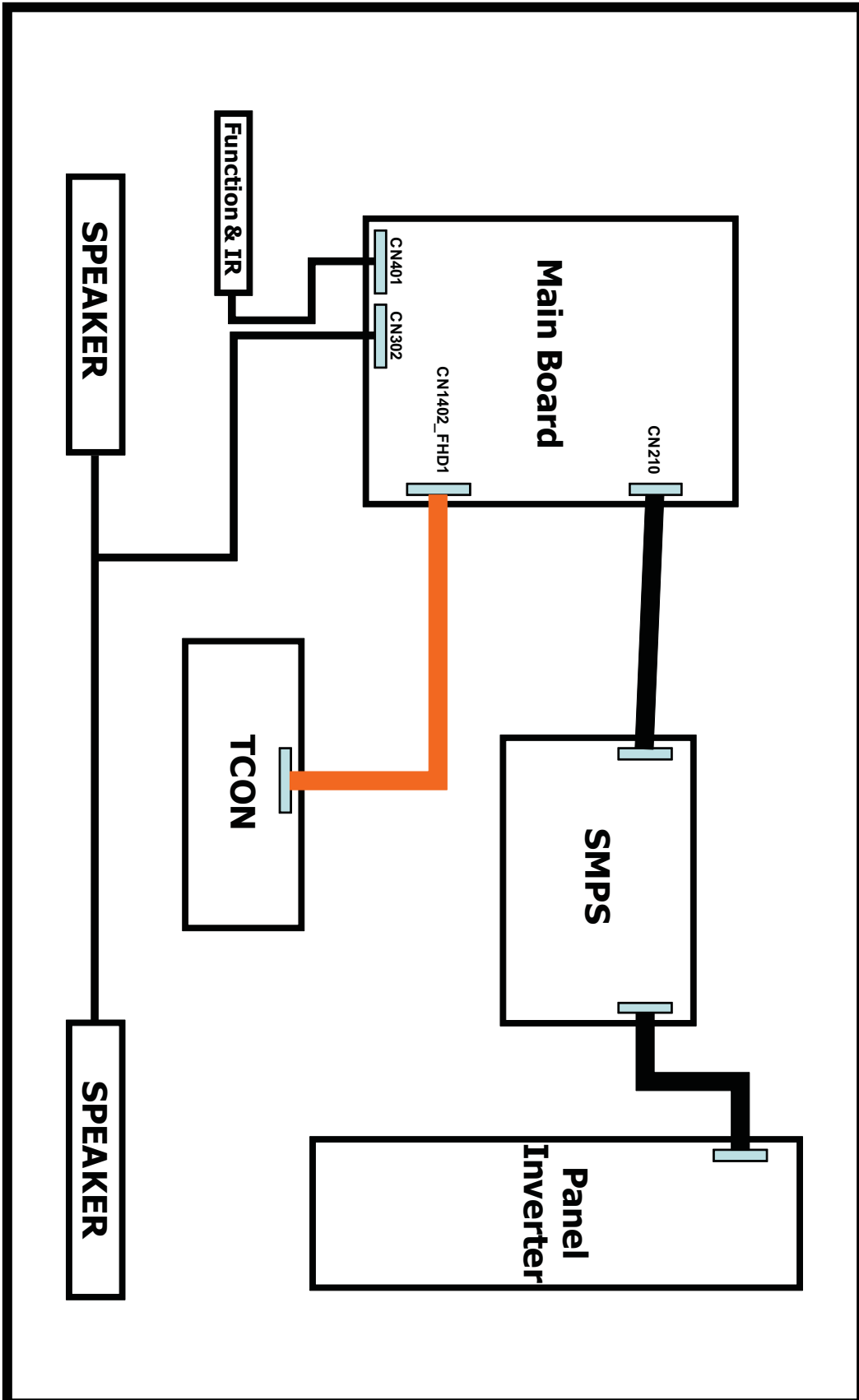

■ 40" _46"

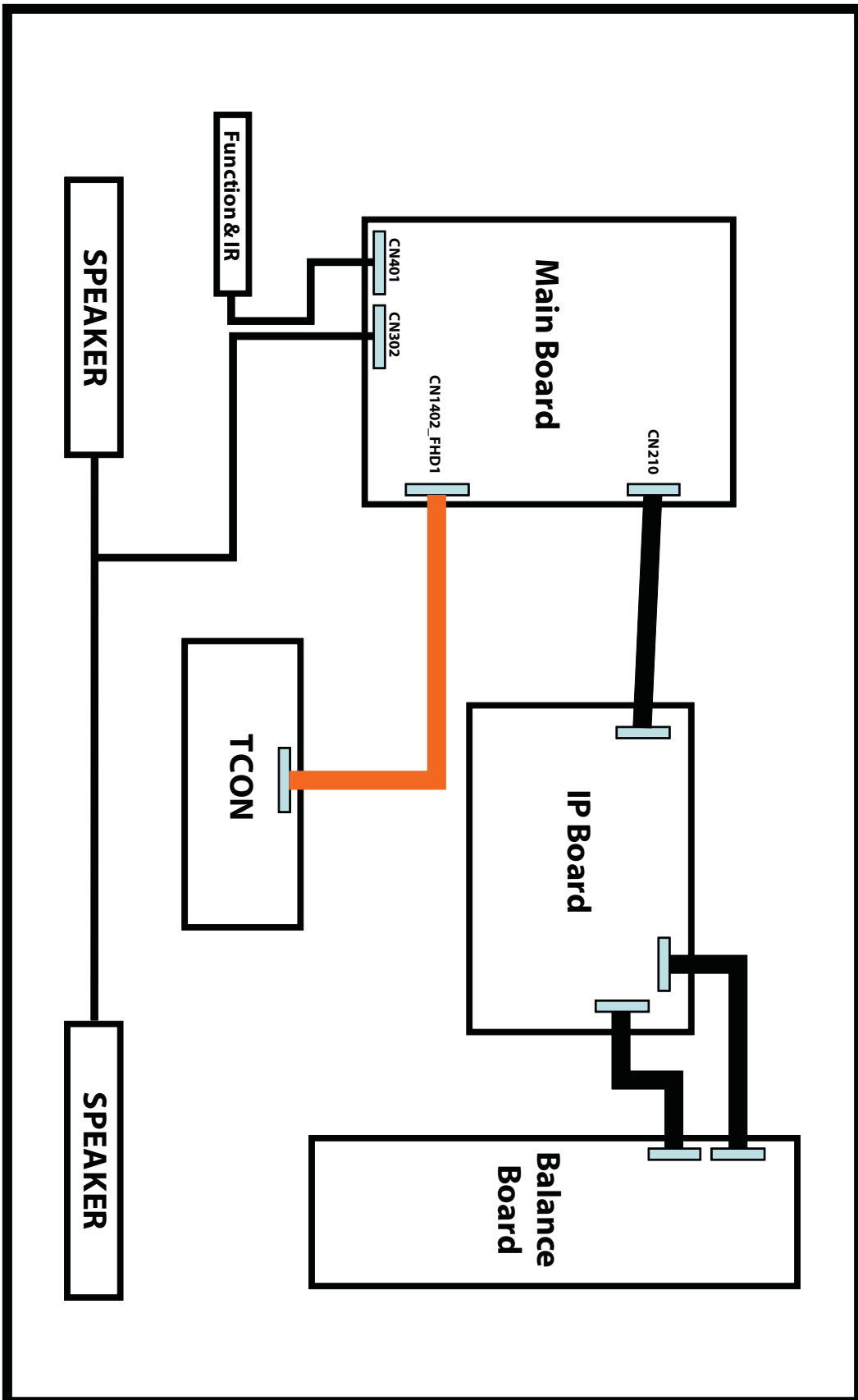

6-2. Connector

CN1405_FHD (to Panel) C5XX			
1	NC	27	EVEN[0]-
2	NC	28	GND
3	NC	29	ODD[4]+
4	NC	30	ODD[4]-
5	NC	31	ODD[3]+
6	NC	32	ODD[3]-
7	FORMAT	33	GND
8	SDA_Panel	34	ODDCLK+
9	TCON_WP	35	ODDCLK-
10	NC	36	GND
11	SDA_Panel	37	ODD[2]+
12	SCL_Panel	38	ODD[2]-
13	GND	39	ODD[1]+
14	EVEN[4]+	40	ODD[1]-
15	EVEN[4]-	41	ODD[0]+
16	EVEN[3]+	42	ODD[0]-
17	EVEN[3]-	43	GND
18	GND	44	GND
19	EVENCLK+	45	GND
20	EVENCLK-	46	NC
21	GND	47	Panel_VCC
22	EVEN[2]+	48	Panel_VCC
23	EVEN[2]-	49	Panel_VCC
24	EVEN[1]+	50	Panel_VCC
25	EVEN[1]-	51	Panel_VCC
26	EVEN[0]+		

CN1403_HD (to Panel) C4XX			
1	Panel_VCC	16	ODD[CLK]+
2	Panel_VCC	17	ODD[CLK]-
3	Panel_VCC	18	GND
4	Panel_VCC	19	ODD[2]+
5	Panel_VCC	20	ODD[2]-
6	GND	21	GND
7	GND	22	ODD[1]+
8	GND	23	ODD[1]-
9	TCON_WP	24	GND
10	FORMAT	25	ODD[0]+
11	NC	26	ODD[0]-
12	GND	27	GND
13	ODD[3]+	28	SDA_TCON
14	ODD[3]-	29	SCL_TCON
15	GND	30	NC

CN210 (to Powr board)			
1	B13VS	10	GND
2	SW_POWER	11	GND
3	B13VS	12	H_OUT
4	A5V	13	B13V
5	B5V	14	PWM_DIMMING
6	B5V	15	B13V
7	B5V	16	SW_INVERTER
8	GND	17	B13V
9	GND	18	LAMP_DET

CN401(FUNCTION)			
1	IR	6	KEY_INPUT1
2	GND	7	KEY_INPUT2
3	A3.3V	8	LED_STB
4	MSCL	9	GND
5	MSDA	10	A3.3V

CN1102_LAN(LAN) C55X/C57X			
1	TX+	5	SB2.5V
2	SB2.5V	6	RX-
3	TX-	7	NC
4	RX+	8	GND

CN902(PC)			
1	PC_RED	9	PC_5V
2	PC_GREEN	10	IDENT_PC
3	PC_BLUE	11	R_FANET
4	T_FANET	12	SDA_DOWN
5	GND	13	PC_HS
6	GND	14	PC_VS
7	GND	15	SCL_DOWN
8	GND		

CN901(PC/DIV SOUND)			
1	GND	4	NC
2	PC_SR_IN	5	NC
3	PC_SL_IN	6	NC

CN802(COMPONENT) / CN7000_AU			
1	COMP1_Y	6	COMP1_SR
2	IDENT_COMP1	7	GND
3	COMP1_PB	8	GND
4	COMP1_PR	9	GND
5	COMP1_SL		

JA701_EU (SCART)			
1	SC_SR_OUT	12	NC
2	SC_SR_IN	13	GND
3	SC_SL_OUT	14	GND
4	GND	15	SC_R
5	GND	16	SC_FB
6	SC_SL_IN	17	GND
7	SC_B	18	GND
8	IDENT_SC	19	SC_CVBS_OUT
9	GND	20	SC_CVBS_IN
10	NC	21	GND
11	SC_G		

CN1302 (SPEAKER)			
1	R+	3	L+
2	R-	4	L-

CN1150_550 (REAR USB) C55X/C57X			
1	USB_VCC	3	USB_DP
2	USB_DM	4	GND

CN1204 (SIDE USB)			
1	USB_VCC	3	USB_DP
2	USB_DM	4	GND

CN704 (SIDE AV)			
1	GND	6	SL_IN
2	IDENT_AV	7	GND
3	CVBS	8	SL_IN
4	GND	9	SR_IN
5	SR_IN		

CN1002 (HDMI1)			
1	HDMI1_RX2+	11	GND
2	GND	12	HDMI1_RXCLK-
3	HDMI1_RX2-	13	HDMI_CEC
4	HDMI1_RX1+	14	GND
5	GND	15	SCL
6	HDMI1_RX1-	16	SDA
7	HDMI1_RX0+	17	GND
8	GND	18	5V
9	HDMI1_RX0-	19	HPD
10	HDMI1_RXCLK+		

CN1003 (HDMI2)			
1	HDMI2_RX2+	11	GND
2	GND	12	HDMI2_RXCLK-
3	HDMI2_RX2-	13	HDMI_CEC
4	HDMI2_RX1+	14	GND
5	GND	15	SCL
6	HDMI2_RX1-	16	SDA
7	HDMI2_RX0+	17	GND
8	GND	18	5V
9	HDMI2_RX0-	19	HPD
10	HDMI2_RXCLK+		

CN1001_550 (HDMI3) C55X/C57X			
1	HDMI3_RX2+	11	GND
2	GND	12	HDMI3_RXCLK-
3	HDMI3_RX2-	13	HDMI_CEC
4	HDMI3_RX1+	14	GND
5	GND	15	SCL
6	HDMI3_RX1-	16	SDA
7	HDMI3_RX0+	17	GND
8	GND	18	5V
9	HDMI3_RX0-	19	HPD
10	HDMI3_RXCLK+		

CN1001 (SIDE HDMI4)			
1	HDMI4_RX2+	11	GND
2	GND	12	HDMI4_RXCLK-
3	HDMI4_RX2-	13	HDMI_CEC
4	HDMI4_RX1+	14	GND
5	GND	15	SCL
6	HDMI4_RX1-	16	SDA
7	HDMI4_RX0+	17	GND
8	GND	18	5V
9	HDMI4_RX0-	19	HPD
10	HDMI4_RXCLK+		

OP1301 (SPDIF)			
1	SPDIF_OUT	3	GND
2	B5V		

CN1301 (HEADPHONG)			
1	GND	4	HP_SL
2	HP_SR	5	HP_SL
3	HP_SL	6	GND

6-3. Connector Functions

Connector	Functions
Main CN210 ↔ IP CN802	Supply main power and dimming signal from IP board to Main Board.
Main CN1405_FHD ↔ T-CON CNF1	The LVDS signal transferred from Main Board to Panel .
IP CN803 ↔ Panel CN1 (14 Pin)	Supply power from IP board to Driver Board.
IP CNI802 ↔ Panel CN1 (2 Pin)	Supply power from IP board to Driver Board.
IP CNI801 ↔ Panel CN3 (7 Pin)	Supply power from IP board to Driver Board.

6-4. Cables

Use	LEAD (Main-IP 18P)	LVDS (Main - TCON)	
Code	32" : BN39-01267A(200mm) 37" : BN39-01267E(250mm) 40" : BN39-01267E(250mm) 46" : BN39-01267F(350mm)	32" : BN96-13171N 37" : BN96-13171B 40" : BN96-13171C 46" : BN96-13171D	
Photo			
Use	LEAD (IP-Driver B'D 14P)	LEAD (IP-Driver B'D 2P)	LEAD (IP-Driver B'D 7P)
Code	32" : BN39-01274A(80mm) 37" : BN39-01272A(100mm)	40"/46" : BN39-01024E (175mm)	40"/46" : BN39-01279E (200mm)
Photo			