



LCD-TV

Chassis : N88A

Model : LA22C450E1
LA26C450E1
LA32C450E1

SERVICE Manual

TFT-LCD TV



LA22C450E1/LA26C450E1/LA32C450E1

Contents

1. Precautions
2. Product specifications
3. Disassembly and Reassembly
4. Troubleshooting
5. Exploded View & Part List
6. Wiring Diagram

Contents

1. Precautions	1-1
1-1. Safety Precautions	1-1
1-2. Servicing Precautions.....	1-2
1-3. Electrostatically Sensitive Devices (ESD) Precautions	1-2
1-4. Installation Precautions	1-3
2. Product specifications	2-1
2-1. Feature & Specifications.....	2-1
2-2. Specification Comparison to Old Models.....	2-4
2-3. Detail Factory Option.....	2-5
2-4. Accessories	2-13
3. Disassembly and Reassembly	3-1
3-1. Disassembly and Reassembly (LA22C450)	3-1
3-2. Disassembly and Reassembly (LA32C450).....	3-4
4. Troubleshooting	4-1
4-1. Troubleshooting	4-1
4-2. Alignments and Adjustments	4-27
4-3. Factory Mode Adjustments	4-28
4-4. White Balance - Calibration	4-47
4-5. White Ratio (Balance) Adjustment.....	4-47
4-6. Servicing Information.....	4-48
5. Exploded View & Part List	5-1
5-1. Exploded View	5-1
5-2. Parts List.....	5-2
6. Wiring Diagram	6-1
6-1. Wiring Diagram.....	6-1
6-2. Connector	6-3
6-3. Connector Functions	6-5
6-4. Cables	6-5



GSPN (Global Service Partner Network)

Area	Web Site
North America	http://service.samsungportal.com
Latin America	http://latin.samsungportal.com
CIS	http://cis.samsungportal.com
Europe	http://europe.samsungportal.com
China	http://china.samsungportal.com
Asia	http://asia.samsungportal.com
Mideast & Africa	http://mea.samsungportal.com

This Service Manual is a property of Samsung Electronics Co.,Ltd.
Any unauthorized use of Manual can be punished under applicable
International and/or domestic law.

© 2010 Samsung Electronics Co.,Ltd.
All rights reserved.
Printed in Korea
P/N: BN82-00753A-00





3. Disassembly and Reassembly

This section of the service manual describes the disassembly and reassembly procedures for the LCD TV.



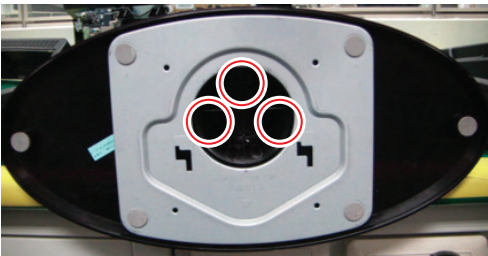

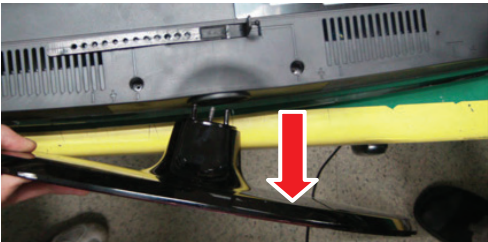
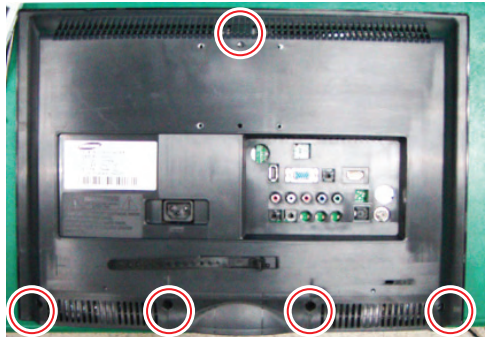
⚠ WARNING: This LCD TV contains electrostatically sensitive devices. Use caution when handling these components.

3-1. Disassembly and Reassembly (LA22C450)

⚠ Cautions: 1. Disconnect the LCD TV from the power source before disassembly.
2. Follow these directions carefully; never use metal instruments to pry apart the cabinet.

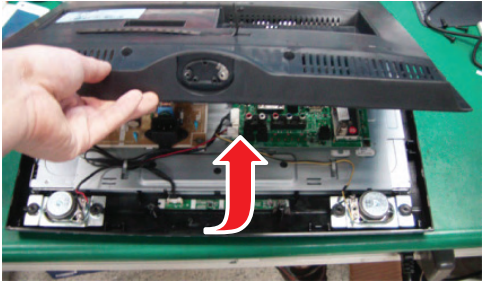
Description	Picture Description	Screws
1. Remove 3 Screws from the stand. Remove stand.		
		 6002-001294 (M4 x L16, Tapping)
		
2. Remove the 5 screws of rear-cover.		 6002-001294 (M4 x L16, Tapping)

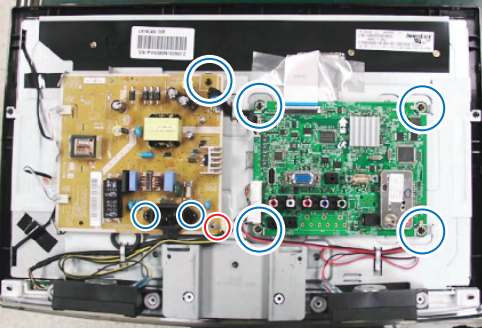
3. Disassembly and Reassembly

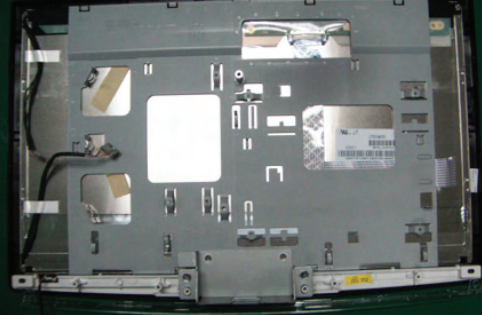

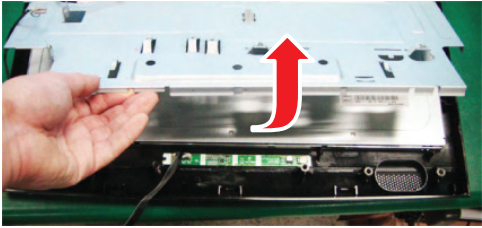
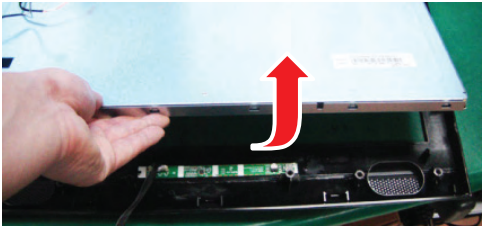

Description	Picture Description	Screws
3. Lift up the rear-cover.		
4. Remove the left and right speaker.		
5. Remove the 4 screws of main board and 4 screws of IP board.		 <p>6003-001439 (M4 x L8, TAPTYPE)</p>  <p>6002-001294 (M4 x L16, Tapping)</p>
6. Remove the bracket stand link.		

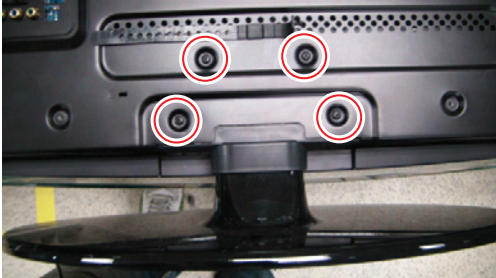

Description	Picture Description	Screws
7. Lift up the stand link.		
8. Lift up the panel.		

※ Reassembly procedures are in the reverse order of disassembly procedures.

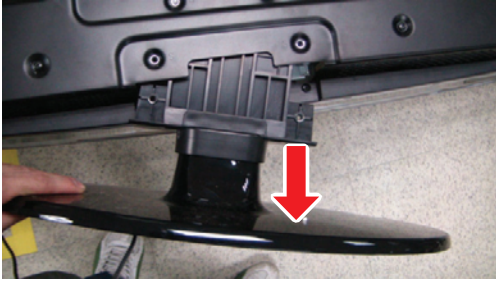



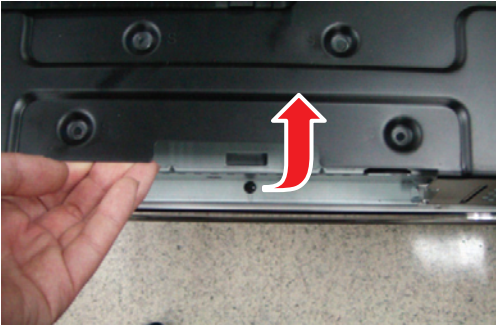
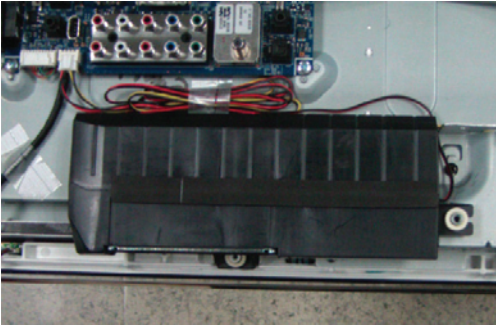
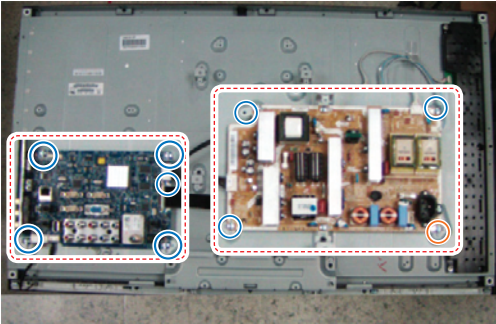

3-2. Disassembly and Reassembly (LA32C450)

- ⚠ Cautions:**
1. Disconnect the LCD TV from the power source before disassembly.
 2. Follow these directions carefully; never use metal instruments to pry apart the cabinet.

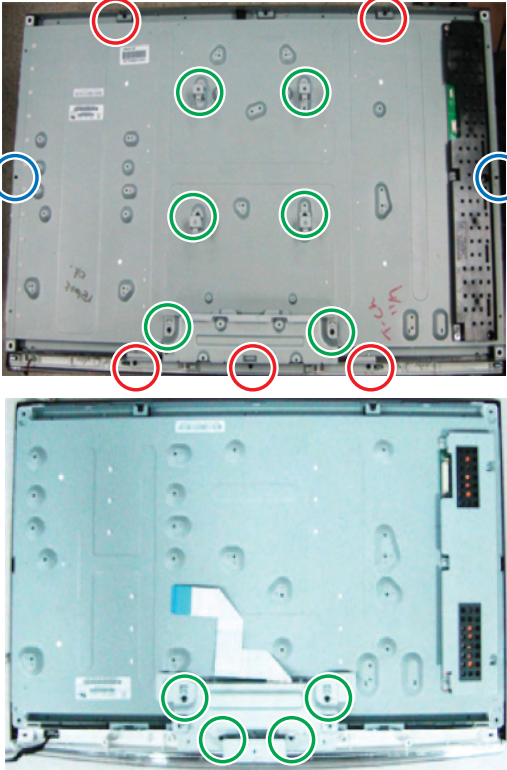
Description	Picture Description	Screws
<p>1. Place the TV face down on cushioned table. Remove 4 screws from the Stand. Remove stand.</p>		
		 6003-001003
		
<p>2. Remove the 9 screws of rear-cover.</p>		 6003-001003

Description	Picture Description	Screws
<p>3. Lift up the rear-cover.</p>		
<p>4. Remove the left and right speaker.</p>		
<p>5. Remove the 5 screws of main board and 4 screws of IP Board.</p>		 <p>6001-002284</p>  <p>6003-001439</p>

3. Disassembly and Reassembly

Description	Picture Description	Screws
<p>6. Remove the 2screws of panel and front. Remove the 4 screws of bracket stand link.</p>		 6003-000337  6003-000337 ONLY 32"C5X0  6003-001003
<p>7. Lift up the stand link.</p>		
<p>8. Lift up the panel.</p>		

※ Reassembly procedures are in the reverse order of disassembly procedures.

Screw Size

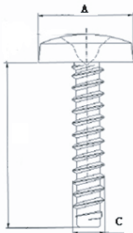
Code No.	A (mm)	B (mm)	C (mm)	Q'ty	
6001-002284	8.3±0.5	8.0±0.6	3.83~3.98	8(26"/32"/37"), 10(40"/46")	
6003-000337	7.3~8.3	9.2~10.0	3.73~3.83	4(26"), 8(32"), 6(37"/40"46")	
6003-001439	8.3±0.4	8.0±0.4	3.85~3.93	1(ALL)	
6003-001003	7.80~8.30	11.20~12.00	3.81~3.91	10(26") 12(32"450) 13(32"5XX). 17(37"), 15(40"), 18(46")	

5. Exploded View & Part List

5-1. LA22C450E1 Exploded View

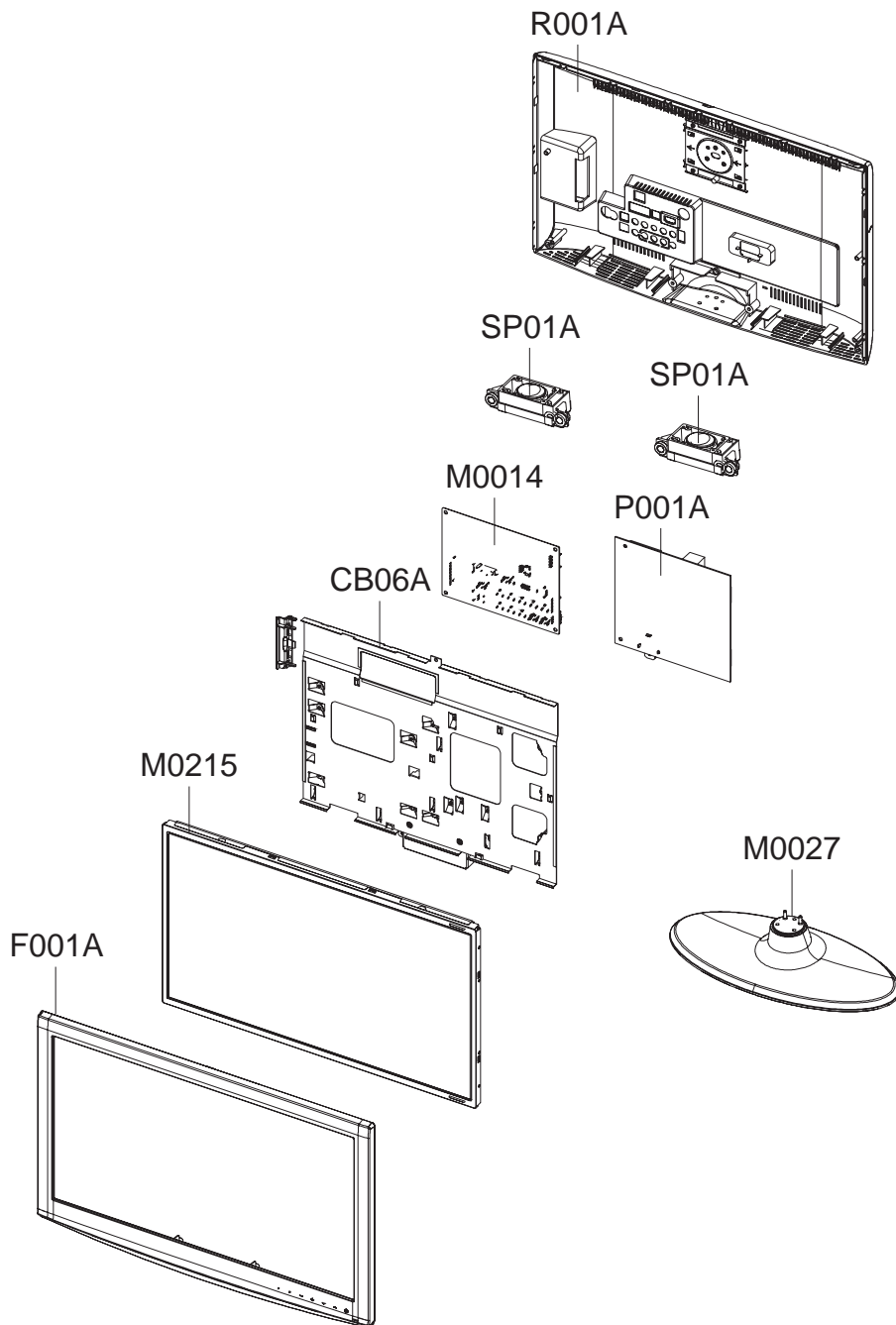

5-2. LA22C450E1 Parts List

Location No.	Code No.	Description & Specification	Q'ty	SA/SNA	Remark
CB06A	BN96-12734D	ASSY BRACKET P-PANEL;LC450 22,SO,T0.8,HD	1	SNA	
F001A	BN96-12731C	ASSY COVER P-FRONT;LC450 22,SO,ABS+PMMA,	1	SA	
M0014	BN94-03325G	ASSY PCB MAIN;LA22C450E1LXL	1	SA	
M0027	BN96-12739A	ASSY STAND P-BASE;LC450 22,ABS+PMMA,HB,B	1	SA	
M0215	BN07-00757A	LCD-PANEL;LTF216AT01,SS6YTS,6bit Hi-FRC,	1	SA	
P001A	BN44-00370B	AC VSS(I)-LIPS;PSIV680510B,EI22HD_ASM,6.	1	SA	
R001A	BN96-12736B	ASSY COVER P-REAR;LC450 22,SO,HIPS,HB,BK	1	SA	
SP01A	BN96-12940C	ASSY SPEAKER P;16ohm,4pin,3W,L:120 R:190	1	SA	

5-2-1. LA22C450E1 Parts List

Service Bom (SA: SERVICE AVAILABLE, SNA: SERVICE NOT AVAILABLE)

Level	Location No.	Code No.	Description & Specification	Q'ty	SA/SNA	Remark
0.1		BN90-02426C	ASSY COVER FRONT;LC450 22	1	SNA	
..2	F001A	BN96-12731C	ASSY COVER P-FRONT;LC450 22,SO,ABS+PMMA,	1	SA	
...3		BN61-04692A	BOSS-PRIMER;#94,clear,35cps	0.001	SNA	
...3		BN61-04731A	BOSS-TAPE;AMBER,ACRYL,T1.1,W8.0mm,WHITE	0.35	SNA	
...3		BN61-06143B	HOLDER-BOSS BOTTOM;LC450 22,ABS,HB,WT003	1	SNA	
...3	F001	BN63-06507C	COVER-FRONT;LC450 22,SO,ABS+PMMA,HB,RD00	1	SNA	
...3	AD070	BN64-01261A	DECORATION-BOTTOM;LC450 22,PC CLEAR,V2,T	1	SNA	
...3		BN68-02553A	LABEL-LCD-POP;L450(22/19),Asia,PET,T0.05	1	SNA	
...3	M0125	BN96-13046C	ASSY BOARD P-TOUCH FUNCTION&IR;LN22C450,	1	SA	
...3		BN60-00162Z	SPACER-FOAM;FOAM,50000mm,Dark Gray,0.35T	1.56	SNA	
...3	AB326	BN61-04661A	BRACKET-STOPPER;L650,SK-5,T0.4,Plating,H	2	SNA	
...3	CCM1	BN63-05199D	COVER-SHEET;AMBER,PE,T0.08,W75mm,200M,CL	0.6	SNA	
...3	CCM1	BN63-05199Q	COVER-SHEET;CREAM,PE,T0.08,W50,200M,CLEA	1.3	SNA	
..2	SP01A	BN96-12940C	ASSY SPEAKER P;16ohm,4pin,3W,L:120 R:190	1	SA	
0.1	R001A	BN90-02430B	ASSY COVER REAR;LC450 22	1	SNA	
..2	T0081	6002-001294	SCREW-TAPPING;BH,+,M4,L16,ZPC(BLK)	6	SA	
..2	R001A	BN96-12736B	ASSY COVER P-REAR;LC450 22,SO,HIPS,HB,BK	1	SA	
...3	T0101	BN61-06145A	BRACKET-WALL;SECC,1.0,LC450 22"	1	SNA	
...3	R001	BN63-06509B	COVER-REAR;LC450 22,HIPS,HB,BK0020	1	SNA	
...3	T0071	BN64-01265A	INLAY-TERMINAL;LC450 22",PS SHEET,T0.5,E	1	SNA	
...3	T0139	BN65-00002A	CLAMPER CORE;BORDEAUX,LDPE,BLK	1	SNA	
0.1	M0216	BN90-02433A	ASSY STAND;LC450 22	1	SNA	
..2	M0027	BN96-12739A	ASSY STAND P-BASE;LC450 22,ABS+PMMA,HB,B	1	SA	
...3	M0081	6003-001001	SCREW-TAPTYPE;FH,+,B,M3,L8,ZPC(BLK),SWRC	4	SNA	
...3		BN61-06187A	BRACKET-STAND BASE;SECC,1.0,LC450 22"	1	SNA	
...3	CCM1	BN63-02183D	COVER-SHEET;RhcM,PE Vinyl,T0.04,680mm,20	0.6	SNA	
...3		BN63-06508A	COVER-STAND BASE;LC450 22,ABS+PMMA,HB,BK	1	SNA	
...3	AR011	BN73-00077A	RUBBER FOOT;MATISSE,BUMPON,#13.5,T2.0,60	6	SNA	
0.1		BN91-04259B	ASSY LCD-AMLCD;BN07-00757A,TN ZBD	1	SNA	
..2	M0215	BN07-00757A	LCD-PANEL;LTF216AT01,SS6YTS,6bit Hi-FRC,	1	SA	
0.1	M0017	BN91-05028G	ASSY CHASSIS;LA22C450E1LXL	1	SNA	
..2	M0014	BN94-03325G	ASSY PCB MAIN;LA22C450E1LXL	1	SA	
...3		3701-001480	CONNECTOR-DSUB;15P,3R,FEMALE,STAMPED PIN	1	SA	
...3	PCN1	3711-004712	HEADER-BOARD TO CABLE;BOX,9P,1R,2mm,STRA	1	SA	
...3	T0527	BN68-00513A	LABEL-E,PASS;ALL MODEL,YUPO(110G),50X15,	1	SNA	
...3	T0527	BN68-01742A	LABEL;Chip Label,10,16	1	SNA	
...3	JA330	3722-003038	JACK-PHONE;7P/1C W/L,SN,BLK	3	SA	
...3		3722-003051	JACK-PIN;3P W/L,NI/SN,YEL/WHT/RED,STRAIG	1	SA	
...3	JA333	3722-003052	JACK-PIN;5P+Shield W/L,NI/SN,GN/BL/RD/WH	1	SA	
...3	T0066	BN62-00040A	HEAT SINK-ES;SAPPHIRE,T2.0,36*36*6.6,BLK	1	SNA	
...3	M0412	BN96-11826C	ASSY BRACKET P-PCB;LB450 40,SPTE T0.5 +	1	SNA	
...4		BN61-04928C	BRACKET-SUPPORT PCB;SPTE,T 0.5,SCREW-M4	1	SNA	
...4		BN61-05262B	HOLDER-BOSS PCB;52,LB550(E0),PBT+G/F(30%	1	SNA	
...3		0202-001608	SOLDER-WIRE FLUX;LFC7-107,D0.8,99.3Sn/0.	0.25	SNA	
...3	CN906	3707-001096	CONNECTOR-OPTICAL;STRAIGHT W/L,SPDIF	1	SA	
...3	CIS3	BN40-00173A	TUNER;DTOS40CVL081A,DVB-T/C,164CH,38.9MH	1	SA	
...3		BN97-04046L	ASSY SMD;NEW MODEL	1	SNA	
...4		0202-001767	SOLDER-CREAM;LST-5710,D20~38,Sn-57Bi-1Ag	2.221	SNA	

5. Exploded View & Part List

Level	Location No.	Code No.	Description & Specification	Q'ty	SA/SNA	Remark
...4	DS01A	0401-001056	DIODE-SWITCHING;MMBD4148SE,100V,200mA,SO	14	SA	
...4		0403-001164	DIODE-ZENER;MMSZ5232B,5.32-5.88V,500MW,S	1	SA	
...4		0403-001783	DIODE-ZENER;BZB84-C6V2,5.8/6.6V,300mW,SO	5	SNA	
...4	D0254	0404-001404	DIODE-SCHOTTKY;BAT721C,40V,200mA,SOT-23,	1	SA	
...4	T0139	0406-001271	DIODE-TVS;RCLAMP0524P,6/-V,150W,SLP251	3	SNA	
...4	SD3	0407-000114	DIODE-SWITCHING;KDS184,80V,100mA,SOT-23,	3	SNA	
...4	Q101	0501-000445	TR-SMALL SIGNAL;KTC3875S-Y,NPN,150mW,SOT	11	SA	
...4	CEQ2	0505-000110	FET-SILICON;2N7002,N,60V,115mA,7.5ohm,0.	6	SA	
...4	Q409	0505-002560	FET-SILICON;AO6415,P,-20V,-3.3A,0.15ohm,	1	SA	
...4	Q409	0505-002572	FET-SILICON;AO4801AL,P,-30V,-5.6A,0.075o	1	SA	
...4	T0596	0904-002554	IC-USC;AU6256-JBF,QFN,28P,5x5mm,12MHz,TP	1	SA	
...4	IC106	1001-001573	IC-VIDEO SWITCH;SiI9287BCNUTR,QFN,72P,10	1	SNA	
...4		1006-001266	IC-LINE TRANSCEIVER;3232,TSSOP,16P,174MI	1	SA	
...4	IC112	1103-000129	IC-EEPROM;24C02,2Kbit,256x8,SOP,8P,5x4mm	2	SA	
...4	IC112	1103-001385	IC-EEPROM;AT24C256,256Kbit,32Kx8,SOP,8P,	1	SA	
...4		1105-002058	IC-DDR2 SDRAM;K4T1G164QE-HCF8,DDR2,1Gbit	2	SA	
...4	T0085	1201-002487	IC-AUDIO AMP;MAX9728A,QFN,12P,3x3mm,DUAL	1	SA	
...4	T0085	1201-002849	IC-AUDIO AMP;DRV603,TSSOP,14P,5x4.4mm,DU	1	SA	
...4	T0124	1201-002993	IC-POWER AMP;TAS5715,HTQFP,48P,7x7mm,DUA	1	SA	
...4	T0087	1203-001815	IC-POSI.FIXED REG.;78M09,TO-252,3P,PLAST	1	SA	
...4	T0087	1203-002835	IC-POSI.FIXED REG.;KIA7805AF,DPAK,3P,6.6	1	SA	
...4	T0087	1203-002898	IC-POSI.FIXED REG.;G950T45R,TO-252,3P,6.	1	SA	
...4		1203-004364	IC-VOL. DETECTOR;RT9818C-42PV,SOT-23,3P,	1	SA	
...4	T0087	1203-005134	IC-POSI.FIXED REG.;RT9167A-33PB,SOT-23-5	1	SNA	
...4		1203-005559	IC-BACKLIGHT DRIVER;MP3302DJ,TSOT23,5P,2	1	SA	
...4		1203-006013	IC-DC/DC CONVERTER;AOZ1031AI,SO-8,8P,4.9	2	SA	
...4		1203-006017	IC-VOL. DETECTOR;RT9824GJ8,TSOT23,8P,2.9	1	SA	
...4	T0087	1203-006135	IC-POSI.FIXED REG.;AP1117D-33-GZ-13-89,T	1	SA	
...4	T0087	1203-006136	IC-POSI.FIXED REG.;AP1117D-18-GZ-13-89,T	1	SA	
...4	IC012	1203-006138	IC-POSI.ADJUST REG.;AP1117DGZ-13-89,TO-2	1	SA	
...4		1203-006288	IC-VOL. DETECTOR;RT9818B-18GV,SOT-23-3,3	1	SA	
...4		1204-003088	IC-DEMODULATOR;DRX39XYK,PQFN,64P,9x9x0.8	1	SA	
...4		1204-003096	IC-VIDEO DECODER;HIDTVPRO-SX,PBGA,580P,P	1	SA	
...4		1205-003201	IC-BUS SWITCH;TC7WB125FK,SSOP,8P,2x2.3mm	2	SA	
...4		1205-003735	IC-SWITCH;AP2151WG-7,SOT25,5P,2.9x1.6mm,	1	SA	
...4		1405-001185	VARISTOR;24Vdc,1.6x0.8x0.36mm,TP	1	SA	
...4		1405-001233	VARISTOR;30Vdc,5A,1.6x0.8x0.8mm,TP	4	SA	
...4		1405-001271	VARISTOR;20Vdc,5A,1.0x0.5x0.6mm,TP	21	SA	
...4	PR6	2007-000072	R-CHIP;47ohm,5%,1/10W,TP,1608	2	SNA	
...4	ZR24	2007-000109	R-CHIP;1Mohm,5%,1/10W,TP,1608	1	SA	
...4	R105	2007-000138	R-CHIP;100ohm,5%,1/16W,TP,1005	26	SA	
...4	AR49	2007-000140	R-CHIP;1Kohm,5%,1/16W,TP,1005	4	SNA	
...4	MR306	2007-000141	R-CHIP;2.2Kohm,5%,1/16W,TP,1005	12	SNA	
...4	R319	2007-000143	R-CHIP;4.7Kohm,5%,1/16W,TP,1005	54	SNA	
...4		2007-000146	R-CHIP;6.8Kohm,5%,1/16W,TP,1005	2	SA	
...4	R104	2007-000148	R-CHIP;10Kohm,5%,1/16W,TP,1005	39	SA	
...4	R102	2007-000149	R-CHIP;12Kohm,5%,1/16W,TP,1005	6	SA	
...4	MR36	2007-000153	R-CHIP;22Kohm,5%,1/16W,TP,1005	8	SNA	
...4	AR43	2007-000155	R-CHIP;27Kohm,5%,1/16W,TP,1005	2	SNA	
...4	RZ07	2007-000156	R-CHIP;30Kohm,5%,1/16W,TP,1005	2	SA	
...4	MR13	2007-000157	R-CHIP;47Kohm,5%,1/16W,TP,1005	2	SNA	

5. Exploded View & Part List

Level	Location No.	Code No.	Description & Specification	Q'ty	SA/SNA	Remark
...4	R123	2007-000159	R-CHIP;56Kohm,5%,1/16W,TP,1005	1	SNA	
...4	DR39	2007-000162	R-CHIP;100Kohm,5%,1/16W,TP,1005	2	SNA	
...4	MR16	2007-000168	R-CHIP;470Kohm,5%,1/16W,TP,1005	2	SA	
...4	R111	2007-000171	R-CHIP;0ohm,5%,1/16W,TP,1005	13	SNA	
...4	HDR17	2007-000172	R-CHIP;10ohm,5%,1/16W,TP,1005	9	SNA	
...4	R338	2007-000173	R-CHIP;22ohm,5%,1/16W,TP,1005	18	SNA	
...4	UR23	2007-000174	R-CHIP;47ohm,5%,1/16W,TP,1005	2	SNA	
...4	R2136	2007-000239	R-CHIP;1.5Kohm,1%,1/10W,TP,1608	1	SNA	
...4	MR9	2007-000455	R-CHIP;18Kohm,1%,1/10W,TP,1608	2	SA	
...4	ER13	2007-000669	R-CHIP;2Kohm,1%,1/10W,TP,1608	1	SNA	
...4	R945	2007-000726	R-CHIP;300ohm,1%,1/10W,TP,1608	1	SA	
...4		2007-000755	R-CHIP;330Kohm,1%,1/10W,TP,1608	1	SA	
...4	R124	2007-000775	R-CHIP;33Kohm,5%,1/16W,TP,1005	3	SNA	
...4	DR37	2007-000932	R-CHIP;470ohm,5%,1/16W,TP,1005	4	SNA	
...4	PR12	2007-000979	R-CHIP;5.6Kohm,1%,1/10W,TP,1608	1	SA	
...4	AAR20	2007-001002	R-CHIP;510ohm,5%,1/10W,TP,1608	1	SNA	
...4		2007-001237	R-CHIP;910ohm,1%,1/10W,TP,1608	1	SNA	
...4		2007-001285	R-CHIP;5.6ohm,5%,1/16W,TP,1005	2	SA	
...4	OTR1	2007-001292	R-CHIP;33ohm,5%,1/16W,TP,1005	10	SNA	
...4	R326	2007-001325	R-CHIP;3.3Kohm,5%,1/16W,TP,1005	11	SNA	
...4		2007-002906	R-CHIP;200Kohm,1%,1/10W,TP,1608	1	SA	
...4	TR30	2007-007009	R-CHIP;75ohm,5%,1/16W,TP,1005	3	SA	
...4	R365	2007-007107	R-CHIP;100Kohm,1%,1/16W,TP,1005	2	SNA	
...4		2007-007134	R-CHIP;39Kohm,1%,1/16W,TP,1005	1	SA	
...4	DR4	2007-007142	R-CHIP;10Kohm,1%,1/16W,TP,1005	4	SNA	
...4		2007-007156	R-CHIP;1ohm,5%,1/16W,TP,1005	8	SA	
...4		2007-007312	R-CHIP;20Kohm,1%,1/16W,TP,1005	3	SA	
...4		2007-007316	R-CHIP;3.3Kohm,1%,1/16W,TP,1005	1	SNA	
...4		2007-007318	R-CHIP;1Kohm,1%,1/16W,TP,1005	11	SNA	
...4		2007-007671	R-CHIP;11Kohm,1%,1/16W,TP,1005	1	SA	
...4		2007-007861	R-CHIP;62Kohm,1%,1/16W,TP,1005	2	SA	
...4	MR11	2007-008015	R-CHIP;75ohm,1%,1/16W,TP,1005	9	SNA	
...4		2007-008134	R-CHIP;12.4Kohm,1%,1/16W,TP,1005	1	SC	
...4		2007-008298	R-CHIP;49.9ohm,1%,1/16W,TP,1005	4	SA	
...4		2007-008593	R-CHIP;750ohm,1%,1/16W,TP,1005	1	SA	
...4	DRP29	2011-001396	R-NETWORK;4.7Kohm,5%,1/16W,L,CHIP,8P,TP,	1	SA	
...4		2011-001427	R-NETWORK;0ohm,5%,1/16W,L,CHIP,8P,TP,2.0	1	SA	
...4		2011-001449	R-NETWORK;22ohm,5%,1/16W,L,4P,TP,1010	2	SA	
...4		2011-001527	R-NETWORK;4.7Kohm,5%,1/16W,L,CHIP,4P,TP,	3	SNA	
...4		2011-001585	R-NETWORK;47ohm,5%,1/16W,L,CHIP-V,4P,TP,	2	SNA	
...4		2011-001589	R-NETWORK;0ohm,5%,1/16W,L,CHIP-V,4P,TP,1	4	SNA	
...4	DC30	2203-000138	C-CER,CHIP;1.5nF,10%,50V,X7R,TP,1005,-	2	SNA	
...4	PC43	2203-000233	C-CER,CHIP;0.1nF,5%,50V,C0G,TP,1005	5	SA	
...4	RC34	2203-000280	C-CER,CHIP;0.01nF,0.5pF,50V,C0G,1608	2	SA	
...4	MC302	2203-000425	C-CER,CHIP;.018nF,5%,50V,C0G,TP,1005	4	SA	
...4	C254	2203-000438	C-CER,CHIP;1nF,10%,50V,X7R,TP,1005	9	SA	
...4	C507	2203-000489	C-CER,CHIP;2.2nF,10%,50V,X7R,TP,1005	3	SA	
...4	ZC14	2203-000626	C-CER,CHIP;0.022nF,5%,50V,C0G,1608	2	SNA	
...4	AD480	2203-000679	C-CER,CHIP;0.027nF,5%,50V,C0G,1005	1	SA	
...4	JC31	2203-000715	C-CER,CHIP;3.3nF,10%,50V,X7R,1608	4	SNA	
...4	DC25	2203-000812	C-CER,CHIP;.033nF,5%,50V,C0G,1005	7	SNA	

5. Exploded View & Part List

Level	Location No.	Code No.	Description & Specification	Q'ty	SA/SNA	Remark
...4	CK40B	2203-000838	C-CER,CHIP;0.39NF,5%,50V,C0G,TP,1608	1	SNA	
...4	KFC6	2203-000872	C-CER,CHIP;0.0030nF,0.25pF,50V,C0G,1608	2	SNA	
...4	AD480	2203-001428	C-CER,CHIP;470nF,10%,50V,X7R,TP,2012	3	SNA	
...4	AD480	2203-002285	C-CER,CHIP;10nF,10%,50V,X7R,1005	15	SNA	
...4	AD480	2203-002525	C-CER,CHIP;0.56nF,10%,50V,X7R,TP,1005	10	SNA	
...4	AAC1	2203-005249	C-CER,CHIP;100nF,10%,50V,X7R,TP,1608	12	SNA	
...4	DC9	2203-005481	C-CER,CHIP;47nF,10%,10V,X7R,TP,1005	1	SA	
...4	AD480	2203-005511	C-CER,CHIP;27nF,10%,10V,X7R,TP,1005	1	SA	
...4	AD480	2203-005968	C-CER,CHIP;4.7NF,10%,50V,X7R,TP,1005	3	SNA	
...4	AD480	2203-006126	C-CER,CHIP;47nF,10%,16V,X7R,1005	2	SNA	
...4	PC11	2203-006141	C-CER,CHIP;1000nF,10%,16V,X5R,1608	5	SNA	
...4	C102	2203-006158	C-CER,CHIP;100nF,10%,16V,X7R,1005	111	SNA	
...4	JC10	2203-006324	C-CER,CHIP;2200nF,10%,10V,X5R,1608	2	SA	
...4	AD480	2203-006336	C-CER,CHIP;10000nF,10%,25V,X5R,3216	7	SA	
...4	C802	2203-006348	C-CER,CHIP;1000nF,10%,25V,X5R,TP,1608	1	SA	
...4	C125	2203-006361	C-CER,CHIP;10000nF,10%,10V,X5R,TP,2012	58	SC	
...4	C234	2203-006378	C-CER,CHIP;4700nF,10%,6.3V,X5R,TP,1608	1	SNA	
...4	HE4	2203-006474	C-CER,CHIP;22000nF,20%,6.3V,X5R,2012	1	SA	
...4	HDC11	2203-006562	C-CER,CHIP;1000nF,10%,10V,X5R,TP,1005	26	SNA	
...4	AD480	2203-006824	C-CER,CHIP;4700nF,10%,10V,X5R,1608	2	SNA	
...4	AD480	2203-006992	C-CER,CHIP;0.33nF,5%,50V,C0G,TP,1005	2	SNA	
...4	T0052	2703-000158	INDUCTOR-SMD;1uH,10%,2012	4	SNA	
...4	T0052	2703-000296	INDUCTOR-SMD;680nH,10%,1608	1	SA	
...4	VL6	2703-000398	INDUCTOR-SMD;10uH,10%,3225	6	SA	
...4	L1103	2703-000403	INDUCTOR-SMD;22uH,10%,3225	1	SA	
...4	T0052	2703-001239	INDUCTOR-SMD;3.3uH,10%,1608	3	SA	
...4	T0052	2703-002268	INDUCTOR-SMD;8.2nH,5%,1005	2	SNA	
...4	T0052	2703-003149	INDUCTOR-SMD;2.2uH,20%,5050	2	SA	
...4	X202	2801-003326	CRYSTAL-SMD;24MHz,30ppm,28-ABX,20pF,50oh	1	SA	
...4	X202	2801-004004	CRYSTAL-SMD;20.25MHz,20ppm,28-AAN,13pF,2	1	SA	
...4	X202	2801-004775	CRYSTAL-SMD;12MHz,30ppm,16pF,30ohm,TP	1	SNA	
...4	F103	2901-001506	FILTER-EMI SMD;5V,0.13A,0pF,2x1x0.5mm,TP	2	SA	
...4	T0568	3301-001082	BEAD-SMD;60ohm,3225,TP,43ohm/40MHz,83ohm	1	SNA	
...4	T0568	3301-001186	BEAD-SMD;600ohm,3216,2500mA,TP,553ohm/93	4	SA	
...4	T0568	3301-001236	BEAD-SMD;60ohm,1608	7	SNA	
...4	T0568	3301-002039	BEAD-SMD;26ohm,1608,TP	44	SA	
...4	T0313	3404-001207	SWITCH-TACT;12V,50mA,160gf,6.2X6.2,SPST	1	SA	
...4		3701-001591	CONNECTOR-HDMI;19P,2ROW,FEMALE,SMD-S,AU	1	SNA	
...4	AC510	3708-001150	CONNECTOR-FPC/FFC/PIC;30P,1mm,SMD-A,SN,Y	1	SA	
...4	HB01A	3711-005601	HEADER-BOARD TO CABLE;BOX,8P,1R,2mm,SMD-	1	SNA	
...4	HB01A	3711-007336	HEADER-BOARD TO CABLE;BOX,4P,1R,2.5mm,SM	1	SA	
...4	T0077	BN41-01377A	PCB MAIN;Trident SX1,FR-4,4,1.0,1.2,192x	1	SNA	
...4		BN97-04127A	ASSY MICOM-SUB2;T-TDT5DAAC-0340.0,L450,A	1	SNA	
....5		1107-001818	IC-NAND FLASH;KFG1G16U2C-DIB6,1024Mbit,6	1	SNA	
...4		BN97-04140A	ASSY MICOM-SUB;T-TDT5DEUS-1002,2010.03.1	1	SNA	
....5	IC115	1107-001580	IC-FLASH MEMORY;MX25L4005,4Mbit,512Kx8,S	1	SNA	
...4	C	2402-001314	C-AL,SMD;100uF,20%,16V,WT,TP,6x5.8mm	1	SA	
...3		3722-003088	JACK-USB;4P/1C,NI/PD/AU/SN,GRY,STRAIGHT,	1	SA	
0.1		BN91-05029F	ASSY SHIELD;LA22C450E1LXL	1	SNA	
..2	W391	6003-000275	SCREW-TAPTYPE;BH,+,B,M3,L10,ZPC(BLK),SWR	7	SA	
..2	M0081	6003-001439	SCREW-TAPTYPE;BH,+,S,M4,L8,ZPC(WHT),SWRC	1	SNA	

5. Exploded View & Part List

Level	Location No.	Code No.	Description & Specification	Q'ty	SA/SNA	Remark
..2	P001A	BN44-00370B	AC VSS(I)-LIPS;PSIV680510B,EI22HD_ASM,6.	1	SA	
..2	FL06	BN96-12447M	ASSY CABLE P-FFC;LA22C450,FFC,1mm PITCH,	1	SA	
..2	CB06A	BN96-12734D	ASSY BRACKET P-PANEL;LC450 22,SO,T0.8,HD	1	SNA	
...3		BN61-02428K	STUD-PEM;PNA,M4,D8,L24,ZPC(SIL),SUM24L	1	SNA	
...3	AB258	BN61-06144D	BRACKET-PANEL;LC450_22inch,SECC,0.8,HDLC	1	SNA	
...3	M0115	BN61-06146A	BRACKET-STAND LINK;SECC,1.6,LC450 22"	1	SNA	
..2		BN73-00206A	SILICON/RUBBER-GAPPAD;UE40B7000WWXXC,SIL	1	SNA	
0.1		BN92-05554K	ASSY BOX;LC450 22	1	SNA	
..2	CCM1	BH68-00572N	LABEL RATING;15", 17" OEM MONITOR,SIEL,F	1	SNA	
..2		BN69-04611G	BOX-SET;22LC450,CB,A-01,SW2, ECT40,YEL,W	1	SNA	
0.1		BN92-05558A	ASSY P/MATERIAL;LC450 22	1	SNA	
..2	S.N.A	0203-001100	TAPE-OPP MASKING;OPP/W75/CLR,T0.075,W75,	1.48	SNA	
..2	T0246	BN69-04454A	CUSHION-SET;22LC450,EPS,16.7g/l	1	SNA	
..2	T0524	6902-001067	BAG PE;HDPE/NITRON,T0.015/T0.5,W700,L600	1	SNA	
0.1	ACCE1	BN92-05759L	ASSY ACCESSORY;LA22C450E1LXL	1	SNA	
..2		BN96-13181L	ASSY ACCESSORY-MANUAL;LA22C450E1LXL	1	SNA	
...3		6801-001523	CARD-WARRANTY;INDIA,SIEL,ENGLISH,ARTPAPE	1	SNA	
...3	T0524	6902-000361	BAG PE;LDPE,T0.05,W400,L240,TRP,8,2,8.00	1	SNA	
...3		AA68-03242M	MANUAL FLYER-MANUAL FLYER-06,SAFETY GUID	1	SNA	
...3	T0511	BN68-00968F	MANUAL USERS;LA32R81BM/XTL,SIEL,ENGLISH,	1	SNA	
...3		BN68-01420C	MANUAL FLYER-SAFETY NOTICE FOR ANTENNA;A	1	SNA	
...3		BN68-02684A	MANUAL USERS-IB;Comm,Samsung,English,Asi	1	SNA	
...3		BN68-02832B	MANUAL FLYER-STAND GUIDE;LC450(22"),SAMS	1	SNA	
..2	ACCE2	BN96-13180K	ASSY ACCESSORY-CABLE;NEW MODEL	1	SNA	
...3	T0685	4301-000103	BATTERY-ALKALINE;1.5V,750mAH,LR03,10.5x4	2	SNA	
...3		BH83-00343C	CKD;SIEL ONLY,SIEL ONLY,NON UL	1	SNA	
...3	REMO2	BN59-01010A	REMOCON;TM950,SAMSUNG,20PIN SINGLE,48KEY	1	SA	
...3	M9889	BN63-01798B	CLOTH-CLEAN;cloth,180,200,sea blue,ToC	1	SA	
...3		BN96-01800K	ASSY ACCESSORY-SCREW ZIPPER;10 LCD-TV,60	1	SNA	
....4	T0081	6002-001294	SCREW-TAPPING;BH,+,,M4,L16,ZPC(BLK)	3	SA	
....4	T0524	6902-001169	BAG PE;LDPE,T0.1,W60,L60,Sealing	1	SNA	
...3	T0524	6902-000361	BAG PE;LDPE,T0.05,W400,L240,TRP,8,2,8.00	1	SNA	
...3	M0254	AA59-00416B	ANT SHIELD BOX;UGC-AS-003A,PAL-BG,DK,I,M	1	SA	
..2	CB25A	BN96-04960C	ASSY BRACKET P-WALL;LC450 22,SECC	1	SNA	
...3		6902-000128	BAG ZIPPER;LDPE,T0.05,W200,L150,TRP,8,2,	1	SNA	
...3	T0101	BN61-01162A	BRACKET-WALL;VE15,SECC,2.0	1	SNA	
...3		BN68-00850N	MANUAL FLYER-WALL POSITION;LC450 22,SAMS	1	SNA	
...3	T0527	BN68-00854A	LABEL-CODE;SP20UO,LABEL,T0.5,10*20	1	SNA	
...3	M0245	BN96-01272A	ASSY MISC P-SCREW;VE15UO	1	SNA	
0.1		BN92-05789B	ASSY LABEL;LA22C450E1XXT	1	SNA	
..2	CCM1	BN68-01176A	LABEL RATING;W/W,SS,PET POLYESTER,T0.05,	1	SNA	
..2	T0527	AA68-03752B	LABEL-STICKER;WW,ALL,Art Paper(90g),25,3	1	SNA	

5. Exploded View & Part List

5-1. LA26C450E1 Exploded View

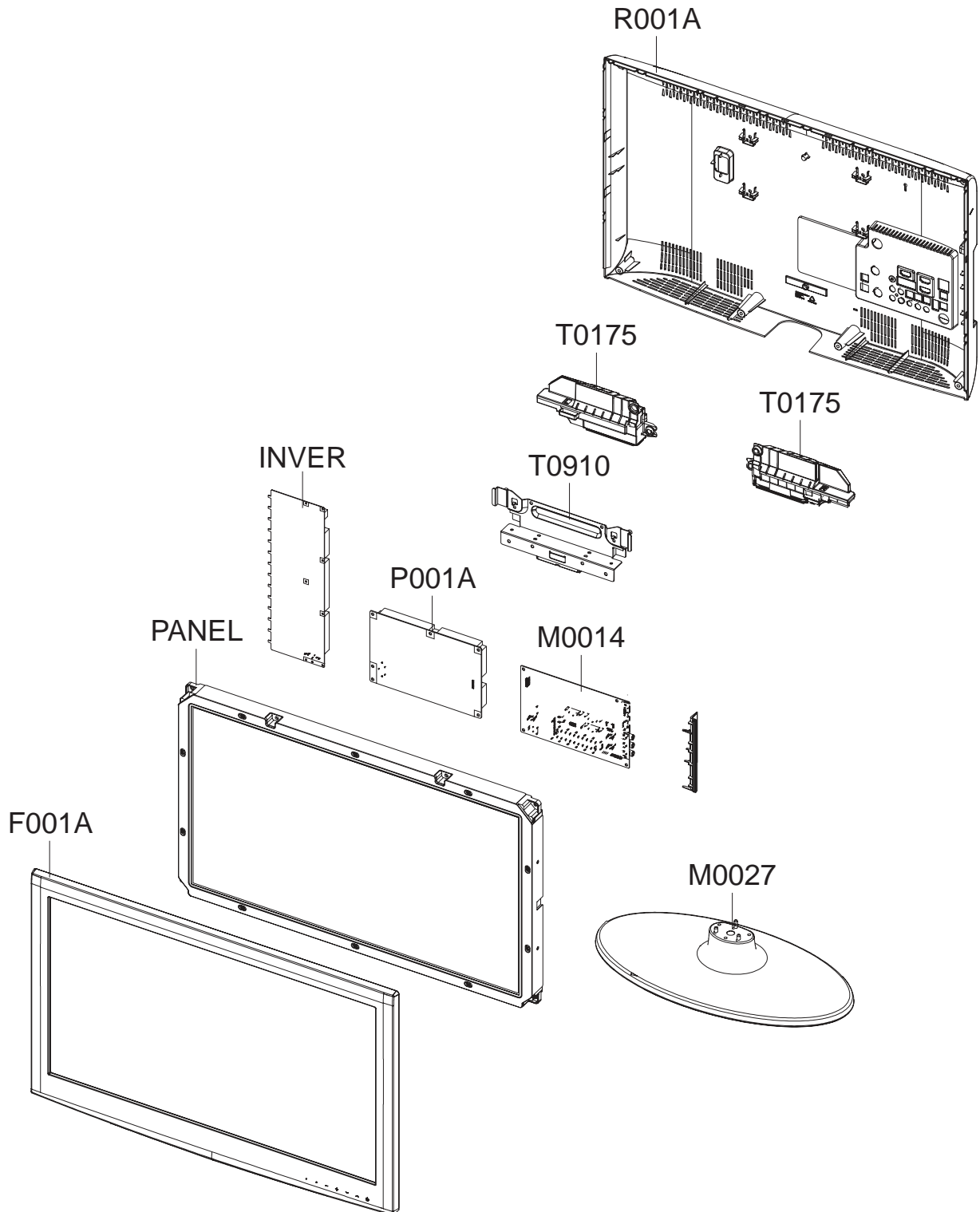

5-2. LA26C450E1 Parts List

Location No.	Code No.	Description & Specification	Q'ty	SA/SNA	Remark
F001A	BN96-12732C	ASSY COVER P-FRONT;LC450 26,SO,ABS+PMMA,	1	SA	
INVER	BN81-04434A	A/S-INV T260XW04 V2;T260XW04 V2	1	SA	
M0014	BN94-03325J	ASSY PCB MAIN;NEW MODEL	1	SA	
M0027	BN96-12869A	ASSY STAND P-BASE;LC350 26,ABS+PMMA,HB,B	1	SA	
P001A	BN44-00338C	DC VSS-LCD TV;PI2632HD_ASM,PSLF121401A,A	1	SA	
PANEL	BN07-00824A	LCD-PANEL;T260XW04 V2,AU26X42,8bit,26,16	1	SA	
R001A	BN96-13305C	ASSY COVER P-REAR;LC450 26,SO,HIPS,HB,BK	1	SA	
T0175	BN96-12975A	ASSY SPEAKER P;16ohm,4pin,5W,L:380 R:160	1	SA	
T0910	BN96-12743A	ASSY BRACKET P-STAND LINK;LC450 26,UO,SE	1	SNA	

5-2-1. LA26C450E1 Parts List

Service Bom (SA: SERVICE AVAILABLE, SNA: SERVICE NOT AVAILABLE)

Level	Location No.	Code No.	Description & Specification	Q'ty	SA/SNA	Remark
0.1		BN90-02427C	ASSY COVER FRONT;LC450 26	1	SNA	
..2	F001A	BN96-12732C	ASSY COVER P-FRONT;LC450 26,SO,ABS+PMMA,	1	SA	
...3	AB326	BN61-04661A	BRACKET-STOPPER;L650,SK-5,T0.4,Plating,H	2	SNA	
...3		BN61-04692A	BOSS-PRIMER;#94,clear,35cps	0.3	SNA	
...3		BN61-04731B	BOSS-TAPE;AMBER,ACRYL,T1.1,W12.0mm,WHITE	0.4	SNA	
...3		BN61-06140B	HOLDER-BOSS BOTTOM;LC450 26,ABS,HB,WT003	1	SNA	
...3	F001	BN63-06504C	COVER-FRONT;LC450 26,SO,ABS+PMMA,HB,RD00	1	SNA	
...3	M0125	BN96-13046D	ASSY BOARD P-TOUCH FUNCTION&IR;LN32C450,	1	SA	
...3		BN60-00162Y	SPACER-FOAM;FOAM,50000mm,Dark Gray,0.35T	1.72	SA	
...3		BN68-02554B	LABEL-LCD-POP;L450(32/26),PET,T0.05,100,	1	SNA	
...3	CCM1	BN63-05199C	COVER-SHEET;AMBER,PE,T0.08,W55mm,200M,CL	1.6	SNA	
...3	CCM1	BN63-05199E	COVER-SHEET;AMBER,PE,T0.08,W85mm,200M,CL	0.7	SNA	
...3	AD070	BN64-01260A	DECORATION-BOTTOM;LC450 26,PC CLEAR,V2,T	1	SNA	
..2	T0175	BN96-12975A	ASSY SPEAKER P;16ohm,4pin,5W,L:380 R:160	1	SA	
0.1	R001A	BN90-02431C	ASSY COVER REAR;LC450 26	1	SNA	
..2	T0081	6002-001294	SCREW-TAPPING;BH,+,,M4,L16,ZPC(BLK)	7	SA	
..2	R001A	BN96-13305C	ASSY COVER P-REAR;LC450 26,SO,HIPS,HB,BK	1	SA	
...3	T0101	BN61-04929A	BRACKET-WALL;26B450,SECC,T1.2	4	SNA	
...3	R001	BN63-06506B	COVER-REAR;LC450 26,SO,HIPS,HB,BK0020	1	SNA	
...3	T0071	BN64-01268A	INLAY-TERMINAL;LC450 26",PS SHEET,T0.5,E	1	SNA	
...3	T0139	BN65-00002A	CLAMPER CORE;BORDEAUX,LDPE,BLK	1	SNA	
0.1	M0017	BN91-05028K	ASSY CHASSIS;LA26C450E1LXL	1	SNA	
..2	M0014	BN94-03325J	ASSY PCB MAIN;NEW MODEL	1	SA	
...3		3701-001480	CONNECTOR-DSUB;15P,3R,FEMALE,STAMPED PIN	1	SA	
...3		3711-007302	HEADER-BOARD TO BOARD;BOX,18P,2R,2mm,ANG	1	SA	
...3	T0527	BN68-00513A	LABEL-E,PASS;ALL MODEL,YUPO(110G),50X15,	1	SNA	
...3	T0527	BN68-01742A	LABEL;Chip Label,10,16	1	SNA	
...3		3722-003037	JACK-USB;4P/1C W/L,AU/NI,BLK,ANGLE,A	1	SA	
...3	JA330	3722-003038	JACK-PHONE;7P/1C W/L,SN,BLK	2	SA	
...3	JA333	3722-003040	JACK-PIN;3P W/L,SN,BLK/YEL/WHT/RED,ANGLE	1	SA	
...3	JA333	3722-003052	JACK-PIN;5P+Shield W/L,NI/SN,GN/BL/RD/WH	2	SA	
...3	T0066	BN62-00040A	HEAT SINK-ES;SAPPHIRE,T2.0,36*36*6.6,BLK	1	SNA	
...3	M0412	BN96-11826C	ASSY BRACKET P-PCB;LB450 40,SPT E T0.5 +	1	SNA	
....4		BN61-04928C	BRACKET-SUPPORT PCB;SPT E T 0.5,SCREW-M4	1	SNA	
....4		BN61-05262B	HOLDER-BOSS PCB;52,LB550(EO),PBT+G/F(30%	1	SNA	
...3		0202-001608	SOLDER-WIRE FLUX;LFC7-107,D0.8,99.3Sn/0.	0.25	SNA	
...3	CN906	3707-001096	CONNECTOR-OPTICAL;STRAIGHT W/L,SPDIF	1	SA	
...3	CIS3	BN40-00173A	TUNER;DTOS40CVL081A,DVB-T/C,164CH,38.9MH	1	SA	
...3		BN97-04046M	ASSY SMD;NEW MODEL	1	SNA	
....4		0202-001767	SOLDER-CREAM;LST-5710,D20~38,Sn-57Bi-1Ag	2.221	SNA	
....4	DS01A	0401-001056	DIODE-SWITCHING;MMBD4148SE,100V,200mA,SO	21	SA	
....4		0403-001164	DIODE-ZENER;MMSZ5232B,5.32-5.88V,500MW,S	1	SA	
....4		0403-001783	DIODE-ZENER;BZB84-C6V2,5.8/6.6V,300mW,SO	8	SNA	
....4	D0254	0404-001404	DIODE-SCHOTTKY;BAT721C,40V,200mA,SOT-23,	1	SA	
....4	T0139	0406-001271	DIODE-TVS;RCLAMP0524P,6/-V,150W,SLP251	7	SNA	
....4	SD3	0407-000114	DIODE-SWITCHING;KDS184,80V,100mA,SOT-23,	3	SNA	
....4	Q101	0501-000445	TR-SMALL SIGNAL;KTC3875S-Y,NPN,150mW,SOT	10	SA	
....4	CEQ2	0505-000110	FET-SILICON;2N7002,N,60V,115mA,7.5ohm,0.	6	SA	

5. Exploded View & Part List

Level	Location No.	Code No.	Description & Specification	Q'ty	SA/SNA	Remark
...4	Q409	0505-002560	FET-SILICON;AO6415,P,-20V,-3.3A,0.15ohm,	1	SA	
...4	T0596	0904-002554	IC-USC;AU6256-JBF,QFN,28P,5x5mm,12MHz,TP	1	SA	
...4	IC106	1001-001573	IC-VIDEO SWITCH;SiI9287BCNUTR,QFN,72P,10	1	SNA	
...4		1006-001266	IC-LINE TRANSCEIVER;3232,TSSOP,16P,174MI	1	SA	
...4	IC112	1103-000129	IC-EEPROM;24C02,2Kbit,256x8,SOP,8P,5x4mm	2	SA	
...4	IC112	1103-001385	IC-EEPROM;AT24C256,256Kbit,32Kx8,SOP,8P,	1	SA	
...4		1105-002058	IC-DDR2 SDRAM;K4T1G164QE-HCF8,DDR2,1Gbit	2	SA	
...4	T0085	1201-002849	IC-AUDIO AMP;DRV603,TSSOP,14P,5x4.4mm,DU	1	SA	
...4	T0124	1201-002993	IC-POWER AMP;TAS5715,HTQFP,48P,7x7mm,DUA	1	SA	
...4	T0087	1203-001815	IC-POSI.FIXED REG.;78M09,TO-252,3P,PLAST	1	SA	
...4	T0087	1203-002835	IC-POSI.FIXED REG.;KIA7805AF,DPAK,3P,6.6	1	SA	
...4	T0087	1203-002898	IC-POSI.FIXED REG.;G950T45R,TO-252,3P,6.	1	SA	
...4		1203-004364	IC-VOL. DETECTOR;RT9818C-42PV,SOT-23,3P,	1	SA	
...4	T0087	1203-005134	IC-POSI.FIXED REG.;RT9167A-33PB,SOT-23-5	1	SNA	
...4		1203-005559	IC-BACKLIGHT DRIVER;MP3302DJ,TSOT23,5P,2	1	SA	
...4		1203-006013	IC-DC/DC CONVERTER;AOZ1031AI,SO-8,8P,4.9	2	SA	
...4		1203-006017	IC-VOL. DETECTOR;RT9824GJ8,TSOT23,8P,2.9	1	SA	
...4	T0087	1203-006135	IC-POSI.FIXED REG.;AP1117D-33-GZ-13-89,T	1	SA	
...4	T0087	1203-006136	IC-POSI.FIXED REG.;AP1117D-18-GZ-13-89,T	1	SA	
...4	IC012	1203-006138	IC-POSI.ADJUST REG.;AP1117DGZ-13-89,TO-2	1	SA	
...4		1203-006288	IC-VOL. DETECTOR;RT9818B-18GV,SOT-23-3,3	1	SA	
...4		1204-003088	IC-DEMODULATOR;DRX39XYK,PQFN,64P,9x9x0.8	1	SA	
...4		1204-003096	IC-VIDEO DECODER;HIDTVPRO-SX,PBGA,580P,P	1	SA	
...4		1205-003201	IC-BUS SWITCH;TC7WB125FK,SSOP,8P,2x2.3mm	2	SA	
...4		1205-003735	IC-SWITCH;AP2151WG-7,SOT25,5P,2.9x1.6mm,	1	SA	
...4		1405-001185	VARISTOR;24Vdc,1.6x0.8x0.36mm,TP	1	SA	
...4		1405-001233	VARISTOR;30Vdc,5A,1.6x0.8x0.8mm,TP	4	SA	
...4		1405-001271	VARISTOR;20Vdc,5A,1.0x0.5x0.6mm,TP	21	SA	
...4	PR6	2007-000072	R-CHIP;47ohm,5%,1/10W,TP,1608	2	SNA	
...4	ZR24	2007-000109	R-CHIP;1Mohm,5%,1/10W,TP,1608	1	SA	
...4	R105	2007-000138	R-CHIP;100ohm,5%,1/16W,TP,1005	29	SA	
...4	AR49	2007-000140	R-CHIP;1Kohm,5%,1/16W,TP,1005	4	SNA	
...4	MR306	2007-000141	R-CHIP;2.2Kohm,5%,1/16W,TP,1005	12	SNA	
...4	R319	2007-000143	R-CHIP;4.7Kohm,5%,1/16W,TP,1005	51	SNA	
...4		2007-000146	R-CHIP;6.8Kohm,5%,1/16W,TP,1005	2	SA	
...4	R104	2007-000148	R-CHIP;10Kohm,5%,1/16W,TP,1005	39	SA	
...4	R102	2007-000149	R-CHIP;12Kohm,5%,1/16W,TP,1005	8	SA	
...4	MR36	2007-000153	R-CHIP;22Kohm,5%,1/16W,TP,1005	5	SNA	
...4	AR43	2007-000155	R-CHIP;27Kohm,5%,1/16W,TP,1005	2	SNA	
...4	RZ07	2007-000156	R-CHIP;30Kohm,5%,1/16W,TP,1005	2	SA	
...4	MR13	2007-000157	R-CHIP;47Kohm,5%,1/16W,TP,1005	4	SNA	
...4	R123	2007-000159	R-CHIP;56Kohm,5%,1/16W,TP,1005	1	SNA	
...4	DR39	2007-000162	R-CHIP;100Kohm,5%,1/16W,TP,1005	2	SNA	
...4	MR16	2007-000168	R-CHIP;470Kohm,5%,1/16W,TP,1005	2	SA	
...4	R111	2007-000171	R-CHIP;0ohm,5%,1/16W,TP,1005	13	SNA	
...4	HDR17	2007-000172	R-CHIP;10ohm,5%,1/16W,TP,1005	11	SNA	
...4	R338	2007-000173	R-CHIP;22ohm,5%,1/16W,TP,1005	19	SNA	
...4	MR9	2007-000455	R-CHIP;18Kohm,1%,1/10W,TP,1608	2	SA	
...4	ER13	2007-000669	R-CHIP;2Kohm,1%,1/10W,TP,1608	1	SNA	
...4	R945	2007-000726	R-CHIP;300ohm,1%,1/10W,TP,1608	1	SA	
...4		2007-000755	R-CHIP;330Kohm,1%,1/10W,TP,1608	1	SA	

5. Exploded View & Part List

Level	Location No.	Code No.	Description & Specification	Q'ty	SA/SNA	Remark
...4	R124	2007-000775	R-CHIP;33Kohm,5%,1/16W,TP,1005	3	SNA	
...4	DR37	2007-000932	R-CHIP;470ohm,5%,1/16W,TP,1005	4	SNA	
...4	PR12	2007-000979	R-CHIP;5.6Kohm,1%,1/10W,TP,1608	1	SA	
...4	AAR20	2007-001002	R-CHIP;510ohm,5%,1/10W,TP,1608	1	SNA	
...4		2007-001237	R-CHIP;910ohm,1%,1/10W,TP,1608	1	SNA	
...4		2007-001285	R-CHIP;5.6ohm,5%,1/16W,TP,1005	2	SA	
...4	OTR1	2007-001292	R-CHIP;33ohm,5%,1/16W,TP,1005	10	SNA	
...4	R326	2007-001325	R-CHIP;3.3Kohm,5%,1/16W,TP,1005	11	SNA	
...4		2007-002906	R-CHIP;200Kohm,1%,1/10W,TP,1608	3	SA	
...4	TR30	2007-007009	R-CHIP;75ohm,5%,1/16W,TP,1005	6	SA	
...4	R365	2007-007107	R-CHIP;100Kohm,1%,1/16W,TP,1005	2	SNA	
...4		2007-007134	R-CHIP;39Kohm,1%,1/16W,TP,1005	1	SA	
...4	DR4	2007-007142	R-CHIP;10Kohm,1%,1/16W,TP,1005	4	SNA	
...4		2007-007156	R-CHIP;1ohm,5%,1/16W,TP,1005	8	SA	
...4		2007-007312	R-CHIP;20Kohm,1%,1/16W,TP,1005	3	SA	
...4		2007-007316	R-CHIP;3.3Kohm,1%,1/16W,TP,1005	1	SNA	
...4		2007-007318	R-CHIP;1Kohm,1%,1/16W,TP,1005	9	SNA	
...4		2007-007671	R-CHIP;11Kohm,1%,1/16W,TP,1005	1	SA	
...4	MR11	2007-008015	R-CHIP;75ohm,1%,1/16W,TP,1005	12	SNA	
...4		2007-008134	R-CHIP;12.4Kohm,1%,1/16W,TP,1005	1	SC	
...4		2007-008298	R-CHIP;49.9ohm,1%,1/16W,TP,1005	4	SA	
...4		2007-008593	R-CHIP;750ohm,1%,1/16W,TP,1005	1	SA	
...4	DRP29	2011-001396	R-NETWORK;4.7Kohm,5%,1/16W,L,CHIP,8P,TP,	1	SA	
...4		2011-001427	R-NETWORK;0ohm,5%,1/16W,L,CHIP,8P,TP,2.0	1	SA	
...4		2011-001449	R-NETWORK;22ohm,5%,1/16W,L,4P,TP,1010	4	SA	
...4		2011-001527	R-NETWORK;4.7Kohm,5%,1/16W,L,CHIP,4P,TP,	3	SNA	
...4		2011-001585	R-NETWORK;47ohm,5%,1/16W,L,CHIP-V,4P,TP,	2	SNA	
...4		2011-001589	R-NETWORK;0ohm,5%,1/16W,L,CHIP-V,4P,TP,1	12	SNA	
...4	PC43	2203-000233	C-CER,CHIP;0.1nF,5%,50V,C0G,TP,1005	5	SA	
...4	RC34	2203-000280	C-CER,CHIP;0.01nF,0.5pF,50V,C0G,1608	2	SA	
...4	MC302	2203-000425	C-CER,CHIP;.018nF,5%,50V,C0G,TP,1005	4	SA	
...4	C254	2203-000438	C-CER,CHIP;1nF,10%,50V,X7R,TP,1005	9	SA	
...4	C507	2203-000489	C-CER,CHIP;2.2nF,10%,50V,X7R,TP,1005	3	SA	
...4	V1233	2203-000575	C-CER,CHIP;220nF,10%,25V,X7R,TP,2012	6	SNA	
...4	ZC14	2203-000626	C-CER,CHIP;0.022nF,5%,50V,C0G,1608	2	SNA	
...4	AD480	2203-000679	C-CER,CHIP;0.027nF,5%,50V,C0G,1005	1	SA	
...4	JC31	2203-000715	C-CER,CHIP;3.3nF,10%,50V,X7R,1608	4	SNA	
...4	DC25	2203-000812	C-CER,CHIP;.033nF,5%,50V,C0G,1005	10	SNA	
...4	CK40B	2203-000838	C-CER,CHIP;0.39nF,5%,50V,C0G,TP,1608	1	SNA	
...4	KFC6	2203-000872	C-CER,CHIP;0.0030nF,0.25pF,50V,C0G,1608	2	SNA	
...4	AD480	2203-001428	C-CER,CHIP;470nF,10%,50V,X7R,TP,2012	3	SNA	
...4	AD480	2203-002285	C-CER,CHIP;10nF,10%,50V,X7R,1005	15	SNA	
...4	AD480	2203-002525	C-CER,CHIP;0.56nF,10%,50V,X7R,TP,1005	10	SNA	
...4	AAC1	2203-005249	C-CER,CHIP;100nF,10%,50V,X7R,TP,1608	14	SNA	
...4	DC9	2203-005481	C-CER,CHIP;47nF,10%,10V,X7R,TP,1005	1	SA	
...4	AD480	2203-005511	C-CER,CHIP;27nF,10%,10V,X7R,TP,1005	1	SA	
...4	AD480	2203-005968	C-CER,CHIP;4.7nF,10%,50V,X7R,TP,1005	3	SNA	
...4	AD480	2203-006126	C-CER,CHIP;47nF,10%,16V,X7R,1005	2	SNA	
...4	PC11	2203-006141	C-CER,CHIP;1000nF,10%,16V,X5R,1608	5	SNA	
...4	C102	2203-006158	C-CER,CHIP;100nF,10%,16V,X7R,1005	118	SNA	
...4	JC10	2203-006324	C-CER,CHIP;2200nF,10%,10V,X5R,1608	2	SA	

5. Exploded View & Part List

Level	Location No.	Code No.	Description & Specification	Q'ty	SA/SNA	Remark
...4	AD480	2203-006336	C-CER,CHIP;1000nF,10%,25V,X5R,3216	7	SA	
...4	C125	2203-006361	C-CER,CHIP;1000nF,10%,10V,X5R,TP,2012	57	SC	
...4	C234	2203-006378	C-CER,CHIP;4700nF,10%,6.3V,X5R,TP,1608	1	SNA	
...4	HE4	2203-006474	C-CER,CHIP;2200nF,20%,6.3V,X5R,2012	1	SA	
...4	HDC11	2203-006562	C-CER,CHIP;1000nF,10%,10V,X5R,TP,1005	20	SNA	
...4	AD480	2203-006824	C-CER,CHIP;4700nF,10%,10V,X5R,1608	1	SNA	
...4	AD480	2203-006841	C-CER,CHIP;1000nF,10%,16V,X5R,1005	1	SNA	
...4	AD480	2203-006992	C-CER,CHIP;0.33nF,5%,50V,C0G,TP,1005	2	SNA	
...4	T0052	2703-000158	INDUCTOR-SMD;1uH,10%,2012	4	SNA	
...4	T0052	2703-000296	INDUCTOR-SMD;680nH,10%,1608	1	SA	
...4	VL6	2703-000398	INDUCTOR-SMD;10uH,10%,3225	6	SA	
...4	L1103	2703-000403	INDUCTOR-SMD;22uH,10%,3225	1	SA	
...4	T0052	2703-001239	INDUCTOR-SMD;3.3uH,10%,1608	3	SA	
...4	T0052	2703-002268	INDUCTOR-SMD;8.2nH,5%,1005	2	SNA	
...4	T0052	2703-003149	INDUCTOR-SMD;2.2uH,20%,5050	2	SA	
...4		2704-000029	INDUCTOR-SMD-ARRAY;5.6uH,2300mA,2,0.08oh	2	SNA	
...4	X202	2801-003326	CRYSTAL-SMD;24MHz,30ppm,28-ABX,20pF,50oh	1	SA	
...4	X202	2801-004004	CRYSTAL-SMD;20.25MHz,20ppm,28-AAN,13pF,2	1	SA	
...4	X202	2801-004775	CRYSTAL-SMD;12MHz,30ppm,16pF,30ohm,TP	1	SNA	
...4	F103	2901-001506	FILTER-EMI SMD;5V,0.13A,0pF,2x1x0.5mm,TP	2	SA	
...4	T0568	3301-001082	BEAD-SMD;60ohm,3225,TP,43ohm/40MHz,83ohm	1	SNA	
...4	T0568	3301-001236	BEAD-SMD;60ohm,1608	7	SNA	
...4	T0568	3301-002039	BEAD-SMD;26ohm,1608,TP	43	SA	
...4	T0313	3404-001207	SWITCH-TACT;12V,50mA,160gf,6.2X6.2,SPST	1	SA	
...4		3601-001374	FUSE-SURFACE MOUNT;32V,5A,FAST-ACTING,Hi	1	SNA	
...4		3701-001591	CONNECTOR-HDMI;19P,2ROW,FEMALE,SMD-S,AU	2	SNA	
...4		3701-001693	CONNECTOR-HDMI;19P,2ROW,FEMALE,SMD-A	1	SA	
...4	AC510	3708-001150	CONNECTOR-FPC/FFC/PIC;30P,1mm,SMD-A,SN,Y	1	SA	
...4	CON_US	3711-005616	HEADER-BOARD TO CABLE;BOX,10P,1R,2mm,SMD	1	SNA	
...4	HB01A	3711-007336	HEADER-BOARD TO CABLE;BOX,4P,1R,2.5mm,SM	1	SA	
...4	T0077	BN41-01377A	PCB MAIN;Trident SX1,FR-4,4,1.0,1.2,192x	1	SNA	
...4		BN97-04127A	ASSY MICOM-SUB2;T-TDT5DAAC-0340.0,L450,A	1	SNA	
....5		1107-001818	IC-NAND FLASH;KFG1G16U2C-DIB6,1024Mbit,6	1	SNA	
...4		BN97-04140A	ASSY MICOM-SUB;T-TDT5DEUS-1002,2010.03.1	1	SNA	
....5	IC115	1107-001580	IC-FLASH MEMORY;MX25L4005,4Mbit,512Kx8,S	1	SNA	
...4	C	2402-001314	C-AL,SMD;100uF,20%,16V,WT,TP,6x5.8mm	1	SA	
0.1		BN91-05029D	ASSY SHIELD;LA26C450E1LXL	1	SNA	
..2	T0081	6001-002284	SCREW-MACHINE;BH,+,M4,L8,ZPC(WHT),SWRCH1	8	SA	
..2	M0081	6003-000337	SCREW-TAPTTYPE;BH,+,S,M4,L10,ZPC(BLK),SWR	2	SA	
..2	M0081	6003-001003	SCREW-TAPTTYPE;BH,+,B,M4,L12,ZPC(BLK),SWR	4	SA	
..2	M2893	BN39-01274A	LEAD CONNECTOR;LC5F,UL 1007 #26,14P,80mm	1	SA	
..2	P001A	BN44-00338C	DC VSS-LCD TV;PI2632HD_ASM,PSLF121401A,A	1	SA	
..2	M0230	BN96-12469D	ASSY CABLE P-FFC;LA26C450,FFC,1mm PITCH,	1	SA	
..2	T0910	BN96-12743A	ASSY BRACKET P-STAND LINK;LC450 26,UO,SE	1	SNA	
...3		BN61-02429K	STUD-PEM;PNB,M3.8,D7,L14.9,ZPC(SIL),SUM2	4	SNA	
...3	M0115	BN61-06142A	BRACKET-STAND LINK;SECC,1.2	1	SNA	
...3		BN61-06252A	BRACKET-SUPPORT LINK;SECC,1.2,LC450 26"	1	SNA	
...3		BN60-00162Y	SPACER-FOAM;FOAM,50000mm,Dark Gray,0.35T	0.11	SA	
...3		BN61-05281A	HOLDER-CLAMP;LCD,NYLON 66,WHT	2	SNA	
..2		BN61-06151C	HOLDER-SIDE AV;LC450 26,ZB,ZL,HIPS,HB,BK	1	SNA	
..2		BN73-00206A	SILICON/RUBBER-GAPPAD;UE40B7000WWXXC,SIL	1	SNA	

5. Exploded View & Part List

Level	Location No.	Code No.	Description & Specification	Q'ty	SA/SNA	Remark
..2	M2893	BN39-01267L	LEAD CONNECTOR;UC4Q,Flat Connector Ass'y	1	SA	
..2	T0081	6001-002604	SCREW-MACHINE;BH,+,M4,L10,ZPC(WHT),SWRCH	1	SA	
0.1		BN91-05061A	ASSY LCD;BN07-00824A	1	SNA	
..2	PANEL	BN07-00824A	LCD-PANEL;T260XW04 V2,AU26X42,8bit,26,16	1	SA	
...3	INVER	BN81-04434A	A/S-INV T260XW04 V2;T260XW04 V2	1	SA	
0.1		BN92-05529J	ASSY BOX;LC450 26	1	SNA	
..2	CCM1	BH68-00572N	LABEL RATING;15", 17" OEM MONITOR,SIEL,F	1	SNA	
..2		BN69-04636G	BOX-SET;26LC450,CB,A-01,SW2,YEL,W729,D49	1	SNA	
0.1		BN92-05533A	ASSY P/MATERIAL;LC450 26	1	SNA	
..2	S.N.A	0203-001100	TAPE-OPP MASKING;OPP/W75/CLR,T0.075,W75,	1.77	SNA	
..2	T0524	6902-000996	BAG PE;HDPE/NITRON,T0.015/T0.5,W800,L600	1	SNA	
..2	T0246	BN69-04453A	CUSHION-01,SET;26LC450,EPS,16.7g/l	1	SNA	
0.1	M0216	BN90-02526A	ASSY STAND;LC350 26	1	SNA	
..2	M0027	BN96-12869A	ASSY STAND P-BASE;LC350 26,ABS+PMMA,HB,B	1	SA	
...3	CCM1	BN63-02183D	COVER-SHEET;Rhcm,PE Vinyl,T0.04,680mm,20	0.4	SNA	
...3		BN63-06687A	COVER-STAND BASE;LC350 26,ABS+PMMA,HB,BK	1	SNA	
...3	M0126	BN73-00052B	RUBBER-FOOT;42Q9,c9,CR Rubber Gray,T3.0	5	SNA	
0.1		BN92-06107G	ASSY LABEL;NEW MODEL	1	SNA	
..2		AA68-03752D	LABEL-STICKER;WW,ALL,Art Paper(90g),44.5	1	SNA	
..2	CCM1	BN68-01176A	LABEL RATING;W/W,SS,PET POLYESTER,T0.05,	1	SNA	
0.1	ACCE1	BN92-06212M	ASSY ACCESSORY;NEW MODEL	1	SNA	
..2	ACCE2	BN96-14636H	ASSY ACCESSORY-CABLE;NEW MODEL	1	SNA	
...3	T0268	3903-000431	CBF-POWER CORD;DT,IN,DP3/Y(A),IEC320 C13	1	SA	
...3	T0685	4301-000103	BATTERY-ALKALINE;1.5V,750mAh,LR03,10.5x4	2	SNA	
...3	T0524	6902-000361	BAG PE;LDPE,T0.05,W400,L240,TRP,8,2,8.00	1	SNA	
...3	REMO2	BN59-01010A	REMOCON;TM950,SAMSUNG,20PIN SINGLE,48KEY	1	SA	
...3	M9889	BN63-01798B	CLOTH-CLEAN;cloth,180,200,sea blue,ToC	1	SA	
...3		BN96-01800K	ASSY ACCESSORY-SCREW ZIPPER;10 LCD-TV,60	1	SNA	
...4	T0081	6002-001294	SCREW-TAPPING;BH,+,M4,L16,ZPC(BLK)	3	SA	
...4	T0524	6902-001169	BAG PE;LDPE,T0.1,W60,L60,Sealing	1	SNA	
...3	M0254	AA59-00416B	ANT SHIELD BOX;UGC-AS-003A,PAL-BG,DK,I,M	1	SA	
..2		BN96-14636Q	ASSY ACCESSORY-MANUAL;LA26C450E1LXL	1	SNA	
...3		6801-001523	CARD-WARRANTY;INDIA,SIEL,ENGLISH,ARTPAPE	1	SNA	
...3	T0524	6902-000361	BAG PE;LDPE,T0.05,W400,L240,TRP,8,2,8.00	1	SNA	
...3		AA68-03242M	MANUAL FLYER-MANUAL FLYER-06,SAFETY GUID	1	SNA	
...3	T0511	BN68-00968F	MANUAL USERS;LA32R81BM/XTL,SIEL,ENGLISH,	1	SNA	
...3		BN68-01420C	MANUAL FLYER-SAFETY NOTICE FOR ANTENNA;A	1	SNA	
...3		BN68-02684A	MANUAL USERS-IB;Comm,Samsung,English,Asi	1	SNA	
...3		BN68-02765B	MANUAL FLYER-STAND GUIDE;L450(26~32),SAM	1	SNA	

5. Exploded View & Part List

5-1. LA32C450E1 Exploded View

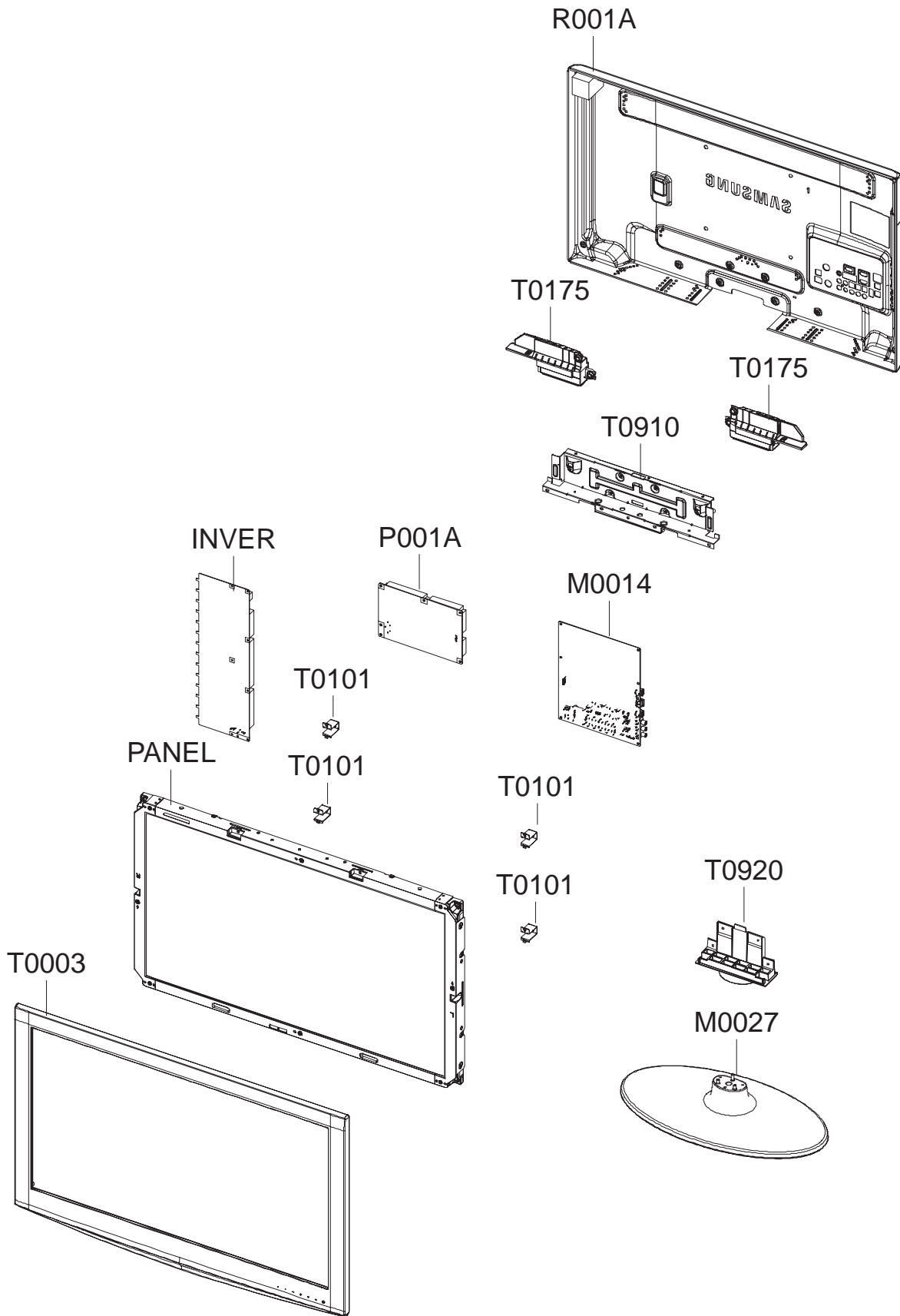

5-2. LA32C450E1 Parts List

Location No.	Code No.	Description & Specification	Q'ty	SA/SNA	Remark
INVER	BN90-02432R	ASSY COVER REAR;LC450 32	1	SNA	
M0014	BN81-04166A	A/S-INVERTER LTF320AP08;LTF320AP08	1	SA	
M0027	BN94-03485D	ASSY PCB MAIN;MODEL	1	SA	
P001A	BN96-12870A	ASSY STAND P-BASE;LC350 32,ABS+PMMA,HB,B	1	SA	
PANEL	BN44-00338C	DC VSS-LCD TV;PI2632HD_ASM,PSLF121401A,A	1	SA	
R001A	BN07-00807A	LCD-PANEL;LTF320AP08,SSCYPZ,8bit,32,16.7	1	SA	
T0003	BN96-12733C	ASSY COVER P-FRONT;LC450 32,SO,ABS+PMMA,	1	SA	
T0101	BN61-05996A	BRACKET-WALL;LC650 40,SECC,T1.2	4	SNA	
T0175	BN96-12871A	ASSY SPEAKER P;6ohm,4pin,10W,L:530 R:170	1	SA	
T0910	BN96-13341A	ASSY BRACKET P-STAND LINK;LC530 32,SECC,	1	SNA	
T0920	BN61-06139B	GUIDE-STAND;LC450 32,ABS HB,BK0020	1	SA	

5-2-1. LA32C450E1 Parts List

Service Bom (SA: SERVICE AVAILABLE, SNA: SERVICE NOT AVAILABLE)

Level	Location No.	Code No.	Description & Specification	Q'ty	SA/SNA	Remark
0.1		BN90-02428C	ASSY COVER FRONT;LC450 32	1	SNA	
..2	T0003	BN96-12733C	ASSY COVER P-FRONT;LC450 32,SO,ABS+PMMA,	1	SA	
...3	W391	6003-000275	SCREW-TAPTYPE;BH,+,B,M3,L10,ZPC(BLK),SWR	4	SA	
...3	M0081	6003-001003	SCREW-TAPTYPE;BH,+,B,M4,L12,ZPC(BLK),SWR	4	SA	
...3	AB326	BN61-04661A	BRACKET-STOPPER;L650,SK-5,T0.4,Plating,H	2	SNA	
...3		BN61-04692A	BOSS-PRIMER;#94,clear,35cps	0.3	SNA	
...3		BN61-04731B	BOSS-TAPE;AMBER,ACRYL,T1.1,W12.0mm,WHITE	0.5	SNA	
...3		BN61-06138A	HOLDER-BOSS BOTTOM;LC450 32,ABS,HB,WT003	1	SNA	
...3	M0112	BN63-06502C	COVER-FRONT;LC450 32,SO,ABS+PMMA,HB,RD00	1	SNA	
...3	M0006	BN63-06503A	COVER-REAR SUB;LC450 32,HIPS,HB,BK0020	1	SNA	
...3	M0125	BN96-13046D	ASSY BOARD P-TOUCH FUNCTION&IR;LN32C450,	1	SA	
...3		BN60-00162Y	SPACER-FOAM;FOAM,50000mm,Dark Gray,0.35T	2.18	SA	
...3		BN68-02554B	LABEL-LCD-POP;L450(32/26),PET,T0.05,100,	1	SNA	
...3	CCM1	BN63-05199B	COVER-SHEET;AMBER,PE,T0.08,W65mm,200M,CL	2	SNA	
...3	CCM1	BN63-05199F	COVER-SHEET;AMBER,PE,T0.08,W95mm,200M,CL	0.85	SNA	
...3	AD070	BN64-01259A	DECORATION-BOTTOM;LC450 32,PC CLEAR,V2,T	1	SNA	
..2	T0175	BN96-12871A	ASSY SPEAKER P;6ohm,4pin,10W,L:530 R:170	1	SA	
0.1		BN91-04885A	ASSY LCD-AMLCD;BN07-00807A	1	SNA	
..2	PANEL	BN07-00807A	LCD-PANEL;LTF320AP08,SSCYPZ,8bit,32,16.7	1	SA	
...3	INVER	BN81-04166A	A/S-INVERTER LTF320AP08;LTF320AP08	1	SA	
0.1		BN91-05029E	ASSY SHIELD;LA32C450E1LXL	1	SNA	
..2	T0081	6001-002284	SCREW-MACHINE;BH,+,M4,L8,ZPC(WHT),SWRCH1	7	SA	
..2	M0081	6003-000337	SCREW-TAPTYPE;BH,+,S,M4,L10,ZPC(BLK),SWR	6	SA	
..2	M0081	6003-001003	SCREW-TAPTYPE;BH,+,B,M4,L12,ZPC(BLK),SWR	7	SA	
..2	M2893	BN39-01267A	LEAD CONNECTOR;LA32B450,UL 2651 AWG#26,1	1	SA	
..2	M2893	BN39-01274A	LEAD CONNECTOR;LC5F,UL 1007 #26,14P,80mm	1	SA	
..2	P001A	BN44-00338C	DC VSS-LCD TV;PI2632HD_ASM,PSLF121401A,A	1	SA	
..2	M0523	BN96-12973A	ASSY BRACKET P-WALL;32,37,40,LC650,SECC,	4	SNA	
...3	T0101	BN61-05996A	BRACKET-WALL;LC650 40,SECC,T1.2	4	SNA	
...3		BN60-00188B	SPACER-FOAM;LCD,FELT,20,3.0,20,Center :	4	SNA	
..2	M0230	BN96-13227A	ASSY CABLE P-FFC;LA32C450,FFC,1mm PITCH,	1	SA	
..2	T0920	BN61-06139B	GUIDE-STAND;LC450 32,ABS HB,BK0020	1	SA	
..2	T0081	6001-002604	SCREW-MACHINE;BH,+,M4,L10,ZPC(WHT),SWRCH	2	SA	
..2		BN61-06441A	HOLDER-INLET;LC530,ABS,V0	1	SNA	
..2	T0910	BN96-13341A	ASSY BRACKET P-STAND LINK;LC530 32,SECC,	1	SNA	
...3	M0115	BN61-06024A	BRACKET-STAND LINK;LC550 32",SECC,T1.2	1	SNA	
...3		BN61-02429K	STUD-PEM;PNB,M3.8,D7,L14.9,ZPC(SIL),SUM2	4	SNA	
...3		BN61-05281A	HOLDER-CLAMP;LCD,NYLON 66,WHT	2	SNA	
..2	M0254	BN61-06066A	HOLDER-SIDE AV;LC550,PC+ABS,V0,BK0008	1	SNA	
..2		BN73-00206A	SILICON/RUBBER-GAPPAD;UE40B7000WWXXC,SIL	1	SNA	
0.1		BN92-05530K	ASSY BOX;LC450 32	1	SNA	
..2	CCM1	BH68-00572N	LABEL RATING;15", 17" OEM MONITOR,SIEL,F	1	SNA	
..2		BN69-04612G	BOX-SET;32LC450,CB,A-01,SW2,YEL,W1008,D1	1	SNA	
0.1		BN92-05534A	ASSY P/MATERIAL;LC450 32	1	SNA	
..2	S.N.A	0203-001100	TAPE-OPP MASKING;OPP/W75/CLR,T0.075,W75,	2.32	SNA	
..2	T0524	6902-000519	BAG PE;HDPE/NITRON,T0.015/T0.05(DOUBLE),	1	SNA	
..2	T0246	BN69-04452A	CUSHION-SET;LC450 32",EPS	1	SNA	
..2		BN68-02422B	LABEL-WARNING SHIPPING;ALL MODEL,A/P 100	1	SNA	

5. Exploded View & Part List

Level	Location No.	Code No.	Description & Specification	Q'ty	SA/SNA	Remark
0.1	ACCE1	BN92-05759X	ASSY ACCESSORY;LA26C450E1LXL	1	SNA	
..2		BN96-13181X	ASSY ACCESSORY-MANUAL;LA26C450E1LXL	1	SNA	
...3		6801-001523	CARD-WARRANTY;INDIA,SIEL,ENGLISH,ARTPAPE	1	SNA	
...3	T0524	6902-000361	BAG PE;LDPE,T0.05,W400,L240,TRP,8,2,8.00	1	SNA	
...3		AA68-03242M	MANUAL FLYER-MANUAL FLYER-06,SAFETY GUID	1	SNA	
...3	T0511	BN68-00968F	MANUAL USERS;LA32R81BM/XTL,SIEL,ENGLISH,	1	SNA	
...3		BN68-01420C	MANUAL FLYER-SAFETY NOTICE FOR ANTENNA;A	1	SNA	
...3		BN68-02684A	MANUAL USERS-IB;Comm,Samsung,English,Asi	1	SNA	
...3		BN68-02765B	MANUAL FLYER-STAND GUIDE;L450(26~32),SAM	1	SNA	
..2	ACCE2	BN96-13180E	ASSY ACCESSORY-CABLE;LA22C450E1LXL	1	SNA	
...3	T0685	4301-000103	BATTERY-ALKALINE;1.5V,750mAh,LR03,10.5x4	2	SNA	
...3	M0254	AA59-00416B	ANT SHIELD BOX;UGC-AS-003A,PAL-BG,DK,I,M	1	SA	
...3	REMO2	BN59-01010A	REMOCON;TM950,SAMSUNG,20PIN SINGLE,48KEY	1	SA	
...3	M9889	BN63-01798B	CLOTH-CLEAN;cloth,180,200,sea blue,ToC	1	SA	
...3		BN96-01800K	ASSY ACCESSORY-SCREW ZIPPER;10 LCD-TV,60	1	SNA	
...4	T0081	6002-001294	SCREW-TAPPING;BH,+,,M4,L16,ZPC(BLK)	3	SA	
...4	T0524	6902-001169	BAG PE;LDPE,T0.1,W60,L60,Sealing	1	SNA	
...3	T0268	3903-000431	CBF-POWER CORD;DT,IN,DP3/Y(A),IEC320 C13	1	SA	
...3	T0524	6902-000361	BAG PE;LDPE,T0.05,W400,L240,TRP,8,2,8.00	1	SNA	
0.1	M0216	BN90-02527A	ASSY STAND;LC350 32	1	SNA	
..2	M0027	BN96-12870A	ASSY STAND P-BASE;LC350 32,ABS+PMMA,HB,B	1	SA	
...3	CCM1	BN63-02183D	COVER-SHEET;Rhcm,PE Vinyl,T0.04,680mm,20	0.4	SNA	
...3		BN63-06688A	COVER-STAND BASE;LC350 32,ABS+PMMA,HB,BK	1	SNA	
...3	M0126	BN73-00052B	RUBBER-FOOT;42Q9,c9,CR Rubber Gray,T3.0	5	SNA	
0.1	R001A	BN90-02432R	ASSY COVER REAR;LC450 32	1	SNA	
..2	M0081	6003-001003	SCREW-TAPTYPE;BH,+,,B,M4,L12,ZPC(BLK),SWR	13	SA	
..2	R001A	BN96-12737P	ASSY COVER P-REAR;LC450 32,SO,PCM T0.5,B	1	SA	
...3	R001	BN63-06392D	COVER-REAR;32,LC550,SO,PCM,T0.5,BLK	1	SNA	
...3		BN60-00162X	SPACER-FOAM;FOAM,30000mm,Dark Gray,1T,15	1.77	SNA	
...3	AH358	BN61-06544A	HOLDER-REAR;LC650 32,PP,BLK	1	SNA	
...3		BN64-01270X	INLAY-AV;LC450 32,ZB/ZL,PS SHEET,T0.3	1	SNA	
...3	T0071	BN64-01298A	INLAY-TERMINAL;LC550,PS SHEET,T0.5,ASIA	1	SNA	
...3	T0139	BN65-00003A	CLAMPER BAG;42C7,LDPE,HB,BLK	1	SNA	
0.1	M0017	BN91-05474D	ASSY CHASSIS;MODEL	1	SNA	
..2	M0014	BN94-03485D	ASSY PCB MAIN;MODEL	1	SA	
...3		0202-001608	SOLDER-WIRE FLUX;LFC7-107,D0.8,99.3Sn/0.	0.25	SNA	
...3		3701-001480	CONNECTOR-DSUB;15P,3R,FEMAIL,STAMPED PIN	1	SA	
...3	CN906	3707-001096	CONNECTOR-OPTICAL;STRAIGHT W/L,SPDIF	1	SA	
...3		3711-007302	HEADER-BOARD TO BOARD;BOX,18P,2R,2mm,ANG	1	SA	
...3		3722-003037	JACK-USB;4P/1C W/L,AU/NI,BLK,ANGLE,A	1	SA	
...3	JA330	3722-003038	JACK-PHONE;7P/1C W/L,SN,BLK	2	SA	
...3	JA333	3722-003040	JACK-PIN;3P W/L,SN,BLK/YEL/WHT/RED,ANGLE	1	SA	
...3	JA333	3722-003052	JACK-PIN;5P+Shield W/L,NI/SN,GN/BL/RD/WH	2	SA	
...3	CIS3	BN40-00173A	TUNER;DTOS40CVL081A,DVB-T/C,164CH,38.9MH	1	SA	
...3	T0066	BN62-00040A	HEAT SINK-ES;SAPPHIRE,T2.0,36*36*6.6,BLK	1	SNA	
...3	T0527	BN68-00513A	LABEL-E,PASS;ALL MODEL,YUPO(110G),50X15,	1	SNA	
...3	T0527	BN68-01742A	LABEL;Chip Label,10,16	1	SNA	
...3	M0412	BN96-11826C	ASSY BRACKET P-PCB;LB450 40,SPTE T0.5 +	1	SNA	
...4		BN61-04928C	BRACKET-SUPPORT PCB;SPTE,T 0.5,SCREW-M4	1	SNA	
...4		BN61-05262B	HOLDER-BOSS PCB;52,LB550(E0),PBT+G/F(30%	1	SNA	
...3		BN97-04046M	ASSY SMD;NEW MODEL	1	SNA	

5. Exploded View & Part List

Level	Location No.	Code No.	Description & Specification	Q'ty	SA/SNA	Remark
....4		0202-001767	SOLDER-CREAM;LST-5710,D20~38,Sn-57Bi-1Ag	2.221	SNA	
....4	DS01A	0401-001056	DIODE-SWITCHING;MMBD4148SE,100V,200mA,SO	21	SA	
....4		0403-001164	DIODE-ZENER;MMSZ5232B,5.32-5.88V,500MW,S	1	SA	
....4		0403-001783	DIODE-ZENER;BZB84-C6V2,5.8/6.6V,300mW,SO	8	SNA	
....4	D0254	0404-001404	DIODE-SCHOTTKY;BAT721C,40V,200mA,SOT-23,	1	SA	
....4	T0139	0406-001271	DIODE-TVS;RCLAMP0524P,6/-V,150W,SLP251	7	SNA	
....4	SD3	0407-000114	DIODE-SWITCHING;KDS184,80V,100mA,SOT-23,	3	SNA	
....4	Q101	0501-000445	TR-SMALL SIGNAL;KTC3875S-Y,NPN,150mW,SOT	10	SA	
....4	CEQ2	0505-000110	FET-SILICON;2N7002,N,60V,115mA,7.5ohm,0.	6	SA	
....4	Q409	0505-002560	FET-SILICON;AO6415,P,-20V,-3.3A,0.15ohm,	1	SA	
....4	T0596	0904-002554	IC-USC;AU6256-JBF,QFN,28P,5x5mm,12MHz,TP	1	SA	
....4	IC106	1001-001573	IC-VIDEO SWITCH;SiI9287BCNUTR,QFN,72P,10	1	SNA	
....4		1006-001266	IC-LINE TRANSCEIVER;3232,TSSOP,16P,174MI	1	SA	
....4	IC112	1103-000129	IC-EEPROM;24C02,2Kbit,256x8,SOP,8P,5x4mm	2	SA	
....4	IC112	1103-001385	IC-EEPROM;AT24C256,256Kbit,32Kx8,SOP,8P,	1	SA	
....4		1105-002058	IC-DDR2 SDRAM;K4T1G164QE-HCF8,DDR2,1Gbit	2	SA	
....4	T0085	1201-002849	IC-AUDIO AMP;DRV603,TSSOP,14P,5x4.4mm,DU	1	SA	
....4	T0124	1201-002993	IC-POWER AMP;TAS5715,HTQFP,48P,7x7mm,DUA	1	SA	
....4	T0087	1203-001815	IC-POSI.FIXED REG.;78M09,TO-252,3P,PLAST	1	SA	
....4	T0087	1203-002835	IC-POSI.FIXED REG.;KIA7805AF,DPAK,3P,6.6	1	SA	
....4	T0087	1203-002898	IC-POSI.FIXED REG.;G950T45R,TO-252,3P,6.	1	SA	
....4		1203-004364	IC-VOL. DETECTOR;RT9818C-42PV,SOT-23,3P,	1	SA	
....4	T0087	1203-005134	IC-POSI.FIXED REG.;RT9167A-33PB,SOT-23-5	1	SNA	
....4		1203-005559	IC-BACKLIGHT DRIVER;MP3302DJ,TSOT23,5P,2	1	SA	
....4		1203-006013	IC-DC/DC CONVERTER;AOZ1031AI,SO-8,8P,4.9	2	SA	
....4		1203-006017	IC-VOL. DETECTOR;RT9824GJ8,TSOT23,8P,2.9	1	SA	
....4	T0087	1203-006135	IC-POSI.FIXED REG.;AP1117D-33-GZ-13-89,T	1	SA	
....4	T0087	1203-006136	IC-POSI.FIXED REG.;AP1117D-18-GZ-13-89,T	1	SA	
....4	IC012	1203-006138	IC-POSI.ADJUST REG.;AP1117DGZ-13-89,TO-2	1	SA	
....4		1203-006288	IC-VOL. DETECTOR;RT9818B-18GV,SOT-23-3,3	1	SA	
....4		1204-003088	IC-DEMODULATOR;DRX39XYK,PQFN,64P,9x9x0.8	1	SA	
....4		1204-003096	IC-VIDEO DECODER;HIDTVPRO-SX,PBGA,580P,P	1	SA	
....4		1205-003201	IC-BUS SWITCH;TC7WB125FK,SSOP,8P,2x2.3mm	2	SA	
....4		1205-003735	IC-SWITCH;AP2151WG-7,SOT25,5P,2.9x1.6mm,	1	SA	
....4		1405-001185	VARISTOR;24Vdc,1.6x0.8x0.36mm,TP	1	SA	
....4		1405-001233	VARISTOR;30Vdc,5A,1.6x0.8x0.8mm,TP	4	SA	
....4		1405-001271	VARISTOR;20Vdc,5A,1.0x0.5x0.6mm,TP	21	SA	
....4	PR6	2007-000072	R-CHIP;47ohm,5%,1/10W,TP,1608	2	SNA	
....4	ZR24	2007-000109	R-CHIP;1Mohm,5%,1/10W,TP,1608	1	SA	
....4	R105	2007-000138	R-CHIP;100ohm,5%,1/16W,TP,1005	29	SA	
....4	AR49	2007-000140	R-CHIP;1Kohm,5%,1/16W,TP,1005	4	SNA	
....4	MR306	2007-000141	R-CHIP;2.2Kohm,5%,1/16W,TP,1005	12	SNA	
....4	R319	2007-000143	R-CHIP;4.7Kohm,5%,1/16W,TP,1005	51	SNA	
....4		2007-000146	R-CHIP;6.8Kohm,5%,1/16W,TP,1005	2	SA	
....4	R104	2007-000148	R-CHIP;10Kohm,5%,1/16W,TP,1005	39	SA	
....4	R102	2007-000149	R-CHIP;12Kohm,5%,1/16W,TP,1005	8	SA	
....4	MR36	2007-000153	R-CHIP;22Kohm,5%,1/16W,TP,1005	5	SNA	
....4	AR43	2007-000155	R-CHIP;27Kohm,5%,1/16W,TP,1005	2	SNA	
....4	RZ07	2007-000156	R-CHIP;30Kohm,5%,1/16W,TP,1005	2	SA	
....4	MR13	2007-000157	R-CHIP;47Kohm,5%,1/16W,TP,1005	4	SNA	
....4	R123	2007-000159	R-CHIP;56Kohm,5%,1/16W,TP,1005	1	SNA	

5. Exploded View & Part List

Level	Location No.	Code No.	Description & Specification	Q'ty	SA/SNA	Remark
...4	DR39	2007-000162	R-CHIP;100Kohm,5%,1/16W,TP,1005	2	SNA	
...4	MR16	2007-000168	R-CHIP;470Kohm,5%,1/16W,TP,1005	2	SA	
...4	R111	2007-000171	R-CHIP;0ohm,5%,1/16W,TP,1005	13	SNA	
...4	HDR17	2007-000172	R-CHIP;10ohm,5%,1/16W,TP,1005	11	SNA	
...4	R338	2007-000173	R-CHIP;22ohm,5%,1/16W,TP,1005	19	SNA	
...4	MR9	2007-000455	R-CHIP;18Kohm,1%,1/10W,TP,1608	2	SA	
...4	ER13	2007-000669	R-CHIP;2Kohm,1%,1/10W,TP,1608	1	SNA	
...4	R945	2007-000726	R-CHIP;300ohm,1%,1/10W,TP,1608	1	SA	
...4		2007-000755	R-CHIP;330Kohm,1%,1/10W,TP,1608	1	SA	
...4	R124	2007-000775	R-CHIP;33Kohm,5%,1/16W,TP,1005	3	SNA	
...4	DR37	2007-000932	R-CHIP;470ohm,5%,1/16W,TP,1005	4	SNA	
...4	PR12	2007-000979	R-CHIP;5.6Kohm,1%,1/10W,TP,1608	1	SA	
...4	AAR20	2007-001002	R-CHIP;510ohm,5%,1/10W,TP,1608	1	SNA	
...4		2007-001237	R-CHIP;910ohm,1%,1/10W,TP,1608	1	SNA	
...4		2007-001285	R-CHIP;5.6ohm,5%,1/16W,TP,1005	2	SA	
...4	OTR1	2007-001292	R-CHIP;33ohm,5%,1/16W,TP,1005	10	SNA	
...4	R326	2007-001325	R-CHIP;3.3Kohm,5%,1/16W,TP,1005	11	SNA	
...4		2007-002906	R-CHIP;200Kohm,1%,1/10W,TP,1608	3	SA	
...4	TR30	2007-007009	R-CHIP;75ohm,5%,1/16W,TP,1005	6	SA	
...4	R365	2007-007107	R-CHIP;100Kohm,1%,1/16W,TP,1005	2	SNA	
...4		2007-007134	R-CHIP;39Kohm,1%,1/16W,TP,1005	1	SA	
...4	DR4	2007-007142	R-CHIP;10Kohm,1%,1/16W,TP,1005	4	SNA	
...4		2007-007156	R-CHIP;1ohm,5%,1/16W,TP,1005	8	SA	
...4		2007-007312	R-CHIP;20Kohm,1%,1/16W,TP,1005	3	SA	
...4		2007-007316	R-CHIP;3.3Kohm,1%,1/16W,TP,1005	1	SNA	
...4		2007-007318	R-CHIP;1Kohm,1%,1/16W,TP,1005	9	SNA	
...4		2007-007671	R-CHIP;11Kohm,1%,1/16W,TP,1005	1	SA	
...4	MR11	2007-008015	R-CHIP;75ohm,1%,1/16W,TP,1005	12	SNA	
...4		2007-008134	R-CHIP;12.4Kohm,1%,1/16W,TP,1005	1	SC	
...4		2007-008298	R-CHIP;49.9ohm,1%,1/16W,TP,1005	4	SA	
...4		2007-008593	R-CHIP;750ohm,1%,1/16W,TP,1005	1	SA	
...4	DRP29	2011-001396	R-NETWORK;4.7Kohm,5%,1/16W,L,CHIP,8P,TP,	1	SA	
...4		2011-001427	R-NETWORK;0ohm,5%,1/16W,L,CHIP,8P,TP,2.0	1	SA	
...4		2011-001449	R-NETWORK;22ohm,5%,1/16W,L,4P,TP,1010	4	SA	
...4		2011-001527	R-NETWORK;4.7Kohm,5%,1/16W,L,CHIP,4P,TP,	3	SNA	
...4		2011-001585	R-NETWORK;47ohm,5%,1/16W,L,CHIP-V,4P,TP,	2	SNA	
...4		2011-001589	R-NETWORK;0ohm,5%,1/16W,L,CHIP-V,4P,TP,1	12	SNA	
...4	PC43	2203-000233	C-CER,CHIP;0.1nF,5%,50V,C0G,TP,1005	5	SA	
...4	RC34	2203-000280	C-CER,CHIP;0.01nF,0.5pF,50V,C0G,1608	2	SA	
...4	MC302	2203-000425	C-CER,CHIP;.018nF,5%,50V,C0G,TP,1005	4	SA	
...4	C254	2203-000438	C-CER,CHIP;1nF,10%,50V,X7R,TP,1005	9	SA	
...4	C507	2203-000489	C-CER,CHIP;2.2nF,10%,50V,X7R,TP,1005	3	SA	
...4	V1233	2203-000575	C-CER,CHIP;220nF,10%,25V,X7R,TP,2012	6	SNA	
...4	ZC14	2203-000626	C-CER,CHIP;0.022nF,5%,50V,C0G,1608	2	SNA	
...4	AD480	2203-000679	C-CER,CHIP;0.027nF,5%,50V,C0G,1005	1	SA	
...4	JC31	2203-000715	C-CER,CHIP;3.3nF,10%,50V,X7R,1608	4	SNA	
...4	DC25	2203-000812	C-CER,CHIP;.033nF,5%,50V,C0G,1005	10	SNA	
...4	CK40B	2203-000838	C-CER,CHIP;0.39NF,5%,50V,C0G,TP,1608	1	SNA	
...4	KFC6	2203-000872	C-CER,CHIP;0.0030nF,0.25pF,50V,C0G,1608	2	SNA	
...4	AD480	2203-001428	C-CER,CHIP;470nF,10%,50V,X7R,TP,2012	3	SNA	
...4	AD480	2203-002285	C-CER,CHIP;10nF,10%,50V,X7R,1005	15	SNA	

5. Exploded View & Part List

Level	Location No.	Code No.	Description & Specification	Q'ty	SA/SNA	Remark
....4	AD480	2203-002525	C-CER,CHIP;0.56nF,10%,50V,X7R,TP,1005	10	SNA	
....4	AAC1	2203-005249	C-CER,CHIP;100nF,10%,50V,X7R,TP,1608	14	SNA	
....4	DC9	2203-005481	C-CER,CHIP;47nF,10%,10V,X7R,TP,1005	1	SA	
....4	AD480	2203-005511	C-CER,CHIP;27nF,10%,10V,X7R,TP,1005	1	SA	
....4	AD480	2203-005968	C-CER,CHIP;4.7NF,10%,50V,X7R,TP,1005	3	SNA	
....4	AD480	2203-006126	C-CER,CHIP;47nF,10%,16V,X7R,1005	2	SNA	
....4	PC11	2203-006141	C-CER,CHIP;1000nF,10%,16V,X5R,1608	5	SNA	
....4	C102	2203-006158	C-CER,CHIP;100nF,10%,16V,X7R,1005	118	SNA	
....4	JC10	2203-006324	C-CER,CHIP;2200nF,10%,10V,X5R,1608	2	SA	
....4	AD480	2203-006336	C-CER,CHIP;10000nF,10%,25V,X5R,3216	7	SA	
....4	C125	2203-006361	C-CER,CHIP;10000nF,10%,10V,X5R,TP,2012	57	SC	
....4	C234	2203-006378	C-CER,CHIP;4700nF,10%,6.3V,X5R,TP,1608	1	SNA	
....4	HE4	2203-006474	C-CER,CHIP;22000nF,20%,6.3V,X5R,2012	1	SA	
....4	HDC11	2203-006562	C-CER,CHIP;1000nF,10%,10V,X5R,TP,1005	20	SNA	
....4	AD480	2203-006824	C-CER,CHIP;4700nF,10%,10V,X5R,1608	1	SNA	
....4	AD480	2203-006841	C-CER,CHIP;1000nF,10%,16V,X5R,1005	1	SNA	
....4	AD480	2203-006992	C-CER,CHIP;0.33nF,5%,50V,C0G,TP,1005	2	SNA	
....4	T0052	2703-000158	INDUCTOR-SMD;1uH,10%,2012	4	SNA	
....4	T0052	2703-000296	INDUCTOR-SMD;680nH,10%,1608	1	SA	
....4	VL6	2703-000398	INDUCTOR-SMD;10uH,10%,3225	6	SA	
....4	L1103	2703-000403	INDUCTOR-SMD;22uH,10%,3225	1	SA	
....4	T0052	2703-001239	INDUCTOR-SMD;3.3uH,10%,1608	3	SA	
....4	T0052	2703-002268	INDUCTOR-SMD;8.2nH,5%,1005	2	SNA	
....4	T0052	2703-003149	INDUCTOR-SMD;2.2uH,20%,5050	2	SA	
....4		2704-000029	INDUCTOR-SMD-ARRAY;5.6uH,2300mA,2,0.08oh	2	SNA	
....4	X202	2801-003326	CRYSTAL-SMD;24MHz,30ppm,28-ABX,20pF,50oh	1	SA	
....4	X202	2801-004004	CRYSTAL-SMD;20.25MHz,20ppm,28-AAN,13pF,2	1	SA	
....4	X202	2801-004775	CRYSTAL-SMD;12MHz,30ppm,16pF,30ohm,TP	1	SNA	
....4	F103	2901-001506	FILTER-EMI SMD;5V,0.13A,0pF,2x1x0.5mm,TP	2	SA	
....4	T0568	3301-001082	BEAD-SMD;60ohm,3225,TP,43ohm/40MHz,83ohm	1	SNA	
....4	T0568	3301-001236	BEAD-SMD;60ohm,1608	7	SNA	
....4	T0568	3301-002039	BEAD-SMD;26ohm,1608,TP	43	SA	
....4	T0313	3404-001207	SWITCH-TACT;12V,50mA,160gf,6.2X6.2,SPST	1	SA	
....4		3601-001374	FUSE-SURFACE MOUNT;32V,5A,FAST-ACTING,Hi	1	SNA	
....4		3701-001591	CONNECTOR-HDMI;19P,2ROW,FEMALE,SMD-S,AU	2	SNA	
....4		3701-001693	CONNECTOR-HDMI;19P,2ROW,FEMALE,SMD-A	1	SA	
....4	AC510	3708-001150	CONNECTOR-FPC/FFC/PIC;30P,1mm,SMD-A,SN,Y	1	SA	
....4	CON_US	3711-005616	HEADER-BOARD TO CABLE;BOX,10P,1R,2mm,SMD	1	SNA	
....4	HB01A	3711-007336	HEADER-BOARD TO CABLE;BOX,4P,1R,2.5mm,SM	1	SA	
....4	T0077	BN41-01377A	PCB MAIN;Trident SX1,FR-4,4,1.0,1.2,192x	1	SNA	
....4		BN97-04127A	ASSY MICOM-SUB2;T-TDT5DAAC-0340.0,L450,A	1	SNA	
....5		1107-001818	IC-NAND FLASH;KFG1G16U2C-DIB6,1024Mbit,6	1	SNA	
....4		BN97-04140A	ASSY MICOM-SUB;T-TDT5DEUS-1002,2010.03.1	1	SNA	
....5	IC115	1107-001580	IC-FLASH MEMORY;MX25L4005,4Mbit,512Kx8,S	1	SNA	
....4	C	2402-001314	C-AL,SMD;100uF,20%,16V,WT,TP,6x5.8mm	1	SA	
0.1		BN92-06107F	ASSY LABEL;NEW MODEL	1	SNA	
..2		AA68-03752D	LABEL-STICKER;WW,ALL,Art Paper(90g),44.5	1	SNA	
..2	T0527	BP68-00052B	LABEL-00,RATING;CCTV,TETRON PAPER,T0.05,	1	SNA	

1. Precautions

1-1. Safety Precautions

Follow these safety, servicing and ESD precautions to prevent damage and to protect against potential hazards such as electrical shock.

1-1-1. Warnings

1. For continued safety, do not attempt to modify the circuit board.
2. Disconnect the AC power and DC power jack before servicing.

1-1-2. Servicing the LCD TV

1. When servicing the LCD TV, Disconnect the AC line cord from the AC outlet.
2. It is essential that service technicians have an accurate voltage meter available at all times. Check the calibration of this meter periodically.

1-1-3. Fire and Shock Hazard

Before returning the LCD TV to the user, perform the following safety checks:

1. Inspect each lead dress to make certain that the leads are not pinched or that hardware is not lodged between the chassis and other metal parts in the LCD TV.
2. Inspect all protective devices such as nonmetallic control knobs, insulating materials, cabinet backs, adjustment and compartment covers or shields, isolation resistor/capacitor networks, mechanical insulators, etc.
3. Leakage Current Hot Check (Figure 1-1):

WARNING : Do not use an isolation transformer during this test.

Use a leakage current tester or a metering system that complies with American National Standards Institute (ANSI C101.1, Leakage Current for Appliances), and Underwriters Laboratories (UL Publication UL1410, 59.7).

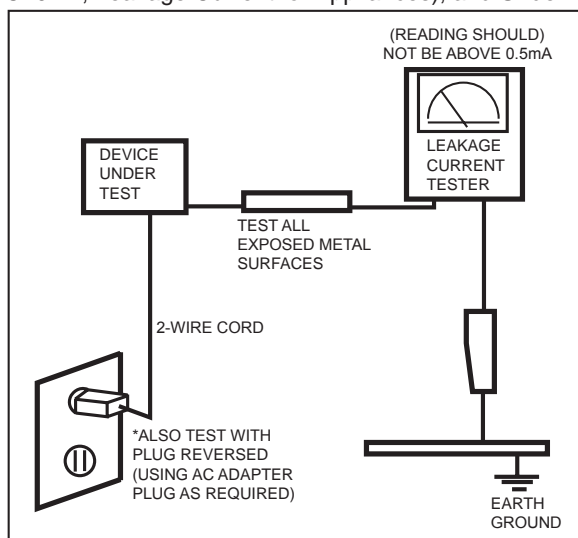

Figure 1-1. Leakage Current Test Circuit

4. With the unit completely reassembled, plug the AC line cord directly into a 120V AC outlet. With the unit's AC switch first in the ON position and then OFF, measure the current between a known earth ground (metal water pipe, conduit, etc.) and all exposed metal parts, including: metal cabinets, screwheads and control shafts. The current measured should not exceed 0.5 milliamp. Reverse the power-plug prongs in the AC outlet and repeat the test.

1-1-4. Product Safety Notices

Some electrical and mechanical parts have special safety-related characteristics which are often not evident from visual inspection. The protection they give may not be obtained by replacing them with components rated for higher voltage, wattage, etc. Parts that have special safety characteristics are identified by \triangle on schematics and parts lists. A substitute replacement that does not have the same safety characteristics as the recommended replacement part might create shock, fire and/or other hazards. Product safety is under review continuously and new instructions are issued whenever appropriate.

1-2. Servicing Precautions

WARNING: An electrolytic capacitor installed with the wrong polarity might explode.

Caution: Before servicing units covered by this service manual, read and follow the Safety Precautions section of this manual.

Note: If unforeseen circumstances create conflict between the following servicing precautions and any of the safety precautions, always follow the safety precautions.

1-2-1 General Servicing Precautions

1. Always unplug the unit's AC power cord from the AC power source and disconnect the DC Power Jack before attempting to:
 - (a) remove or reinstall any component or assembly, (b) disconnect PCB plugs or connectors, (c) connect a test component in parallel with an electrolytic capacitor.
2. Some components are raised above the printed circuit board for safety. An insulation tube or tape is sometimes used. The internal wiring is sometimes clamped to prevent contact with thermally hot components. Reinstall all such elements to their original position.
3. After servicing, always check that the screws, components and wiring have been correctly reinstalled. Make sure that the area around the serviced part has not been damaged.
4. Check the insulation between the blades of the AC plug and accessible conductive parts (examples: metal panels, input terminals and earphone jacks).
5. Insulation Checking Procedure: Disconnect the power cord from the AC source and turn the power switch ON. Connect an insulation resistance meter (500 V) to the blades of the AC plug. The insulation resistance between each blade of the AC plug and accessible conductive parts (see above) should be greater than 1 megohm.
6. Always connect a test instrument's ground lead to the instrument chassis ground before connecting the positive lead; always remove the instrument's ground lead last.

1-3. Electrostatically Sensitive Devices (ESD) Precautions

Some semiconductor (solid state) devices can be easily damaged by static electricity. Such components are commonly called Electrostatically Sensitive Devices (ESD). Examples of typical ESD are integrated circuits and some field-effect transistors. The following techniques will reduce the incidence of component damage caused by static electricity.

1. Immediately before handling any semiconductor components or assemblies, drain the electrostatic charge from your body by touching a known earth ground. Alternatively, wear a discharging wrist-strap device. To avoid a shock hazard, be sure to remove the wrist strap before applying power to the LCD TV.
2. After removing an ESD-equipped assembly, place it on a conductive surface such as aluminum foil to prevent accumulation of an electrostatic charge.
3. Do not use freon-propelled chemicals. These can generate electrical charges sufficient to damage ESDs.
4. Use only a grounded-tip soldering iron to solder or desolder ESDs.
5. Use only an anti-static solder removal device. Some solder removal devices not classified as "anti-static" can generate electrical charges sufficient to damage ESDs.
6. Do not remove a replacement ESD from its protective package until you are ready to install it. Most replacement ESDs are packaged with leads that are electrically shorted together by conductive foam, aluminum foil or other conductive materials.
7. Immediately before removing the protective material from the leads of a replacement ESD, touch the protective material to the chassis or circuit assembly into which the device will be installed.

Caution: Be sure no power is applied to the chassis or circuit and observe all other safety precautions.
8. Minimize body motions when handling unpackaged replacement ESDs. Motions such as brushing clothes together, or lifting your foot from a carpeted floor can generate enough static electricity to damage an ESD.

1-4. Installation Precautions

1. For safety reasons, more than a people are required for carrying the product.
2. Keep the power cord away from any heat emitting devices, as a melted covering may cause fire or electric shock.
3. Do not place the product in areas with poor ventilation such as a bookshelf or closet. The increased internal temperature may cause fire.
4. Bend the external antenna cable when connecting it to the product. This is a measure to protect it from being exposed to moisture. Otherwise, it may cause a fire or electric shock.
5. Make sure to turn the power off and unplug the power cord from the outlet before repositioning the product. Also check the antenna cable or the external connectors if they are fully unplugged. Damage to the cord may cause fire or electric shock.
6. Keep the antenna far away from any high-voltage cables and install it firmly. Contact with the highvoltage cable or the antenna falling over may cause fire or electric shock.
7. When installing the product, leave enough space (0.4m) between the product and the wall for ventilation purposes. A rise in temperature within the product may cause fire.

Memo

2. Product specifications

2-1. Feature & Specifications

Model	LA22C450E1	
Feature		
<ul style="list-style-type: none"> ▶ RF, 1-HDMI, 1-Component/AV, 1-AV, 1-USB2.0, D-SUB, Optical, Audio Out, Headphone ▶ Brightness : 500 cd/m² ▶ Response Time : 6.5ms 		
Specifications		
Item	Description	
LCD Panel	22inch HD 50/60Hz	
Scanning Frequency	Horizontal : 60 kHz ~ 73 kHz (Automatic) Vertical : 47 Hz ~ 63 Hz (Automatic)	
Display Colors	16.7M color	
Maximum resolution	Horizontal : 1366 Pixels Vertical : 768 pixels	
Input Signal	Analog 0.7 Vp-p ± 5% positive at 75Ω, internally terminated	
Input Sync Signal	H/V Separate, TTL, P. or N.	
Maximum Pixel Clock rate	76MHz	
Active Display Horizontal/Vertical	18.96 x 10.73 inches (481.5(H) x 272.5(V) mm)	
AC power voltage & Frequency	AC 110V ~ 240V, 50/60Hz	
Power Consumption	Under 55W (Under 0.3W, Stand by)	
Dimensions Set (W x D x H)	21.0 x 6.8 x 15.8 inches (533.2 x 171.9 x 402.5 mm)_with stand 21.0 x 2.4 x 13.9 inches (533.2 x 60.8 x 354.1 mm)_without stand	
Weight	11.46 lbs (5.20kg)_with stand 10.38 lbs (4.71kg)_without stand	
TV System	Tunning	Frequency Synthesize (Refer to detailed Frequency Table)
	System	PAL, SECAM, NT4.43, NT3.58
	Sound	BG, DK, M, I
Environmental Considerations	Operating Temperature : 32°F ~ 122°F (0°C ~ 50°C) Operating Humidity : 10% ~ 90% Storage temperature : -4°F ~ 140°F (-20°C ~ 60°C) Storage Humidity: 10% ~ 90%	
Audio Spec.	<ul style="list-style-type: none"> - MAX Internal Audio Output Power : Each 3W(Left/Right) - Equalizer : 5band - Output Frequency : RF : 20 Hz ~ 15.4 kHz AV/Componet/HDMI : 20 Hz ~ 20 kHz 	
Note: Dolby Digital*, Game Mode, Film Mode, Energy Saving, Anynet*		



2. Product specifications

Model	LA26C450E1	
Feature		
<ul style="list-style-type: none"> ▶ RF, 3-HDMI, 2-Component/AV, 1-USB2.0, D-SUB, Optical, Audio Out, FM Transmitter ▶ Brightness : 500 cd/m² ▶ Response Time : 6.5ms 		
Specifications		
Item	Description	
LCD Panel	26inch HD 50/60Hz	
Scanning Frequency	Horizontal : 60 kHz ~ 73 kHz (Automatic) Vertical : 47 Hz ~ 63 Hz (Automatic)	
Display Colors	16.7M color	
Maximum resolution	Horizontal : 1366 Pixels Vertical : 768 pixels	
Input Signal	Analog 0.7 Vp-p ± 5% positive at 75Ω, internally terminated	
Input Sync Signal	H/V Separate, TTL, P. or N.	
Maximum Pixel Clock rate	76MHz	
Active Display Horizontal/Vertical	22.67 x 12.74 inches (575.769 (H) x 323.712 (V) mm)	
AC power voltage & Frequency	AC 110V ~ 240V, 50/60Hz	
Power Consumption	Under 90W (Under 0.3W, Stand by)	
Dimensions Set (W x D x H)	25.5 x 8.8 x 18.7 nchs (646.5 x 222.2 x 475.8 mm)_with stand 25.5 x 3.0 x 17.0 inches (646.5 x 77.0 x 432.3 mm)_without stand	
Weight	14.66 lbs (6.65kg)_with stand 13.76 lbs (6.24kg)_without stand	
TV System	Tunning	Frequency Synthesize (Refer to detailed Frequency Table)
	System	PAL, SECAM, NT4.43,NT3.58
	Sound	BG, DK, M, I
Environmental Considerations	Operating Temperature : 32°F ~ 122°F (0°C ~ 50°C) Operating Humidity : 10% ~ 90% Storage temperature : -4°F ~ 140°F (-20°C ~ 60°C) Storage Humidity: 10% ~ 90%	
Audio Spec.	<ul style="list-style-type: none"> - MAX Internal Audio Output Power : Each 5W(Left/Right) - Equalizer : 5band - Output Frequency : RF : 20 Hz ~ 15.4 kHz AV/Componet/HDMI : 20 Hz ~ 20 kHz 	
Note: Dolby Digital ⁺ , Game Mode, Film Mode, Energy Saving, Anynet ⁺		

Model	LA32C450E1	
Feature		
<ul style="list-style-type: none"> ▶ RF, 3-HDMI, 2-Component/AV, 1-USB2.0, D-SUB, Optical, Audio Out, FM Transmitter ▶ Brightness : 500cd//m² ▶ Response Time : 6.5 ms 		
Specifications		
Item	Description	
LCD Panel	32inch HD 50/60Hz	
Scanning Frequency	Horizontal : 60 kHz ~ 73 kHz (Automatic) Vertical : 47 Hz ~ 63 Hz (Automatic)	
Display Colors	16.7M color	
Maximum resolution	Horizontal : 1366 Pixels Vertical : 768 pixels	
Input Signal	Analog 0.7 Vp-p ± 5% positive at 75Ω, internally terminated	
Input Sync Signal	H/V Separate, TTL, P. or N.	
Maximum Pixel Clock rate	76MHz	
Active Display Horizontal/Vertical	27.50 x 15.47 inches (698.4 (H) x 392.85 (V) mm)	
AC power voltage & Frequency	AC 110V ~ 240V, 50/60Hz	
Power Consumption	Under 120W (Under 0.3W, Stand by)	
Dimensions Set (W x D x H)	30.9 x 9.7 x 22.8 inches (784.4 x 247.2 x 580.0 mm)_with stand 30.9 x 3.0 x 20.2 inches (784.4 x 76.1 x 514.2 mm)_without stand	
Weight	20.30 lbs (9.21kg)_with stand 18.96 lbs (8.6kg)_without stand	
TV System	Tunning	Frequency Synthesize (Refer to detailed Frequency Table)
	System	PAL, SECAM, NT4.43,NT3.58
	Sound	BG, DK, M, I
Environmental Considerations	Operating Temperature : 32°F ~ 122°F (0°C ~ 50°C) Operating Humidity : 10% ~ 90% Storage temperature : -4°F ~ 140°F (-20°C ~ 60°C) Storage Humidity: 10% ~ 90%	
Audio Spec.	<ul style="list-style-type: none"> - MAX Internal Audio Output Power : Each 10W(Left/Right) - Equalizer : 5band - Output Frequency : RF : 20 Hz ~ 15.4 kHz AV/Componet/HDMI : 20 Hz ~ 20 kHz 	
Note: Dolby Digital+, Game Mode, Film Mode, Energy Saving, Anynet*		

2-2. Specification Comparison to Old Models

※ O : application, X : non-application

Model	LC4E(LA**C450E1)	LB4B(LA**B450B1)
Design		
Display Type	LCD TV	LCD TV
Built-in Tuner	O	O
Resolution	1366 x 768	1366 x 768
LCD Panel	TFT LCD Panel 50/60Hz	TFT LCD Panel 50/60Hz
Screen Size	22"/26"/32"	26"/32"/37"/40"
Picture ratio	16 : 9	16 : 9
Dimensions (W x H x D)	22" 21.0 x 6.8 x 15.8 inches_with stand 26" 25.5 x 8.8 x 17.0 inches _with stand 32" 26.0 x 9.7 x 22.8 inches _with stand	26" 26.0 x 8.5 x 19.4 inches _with stand 32" 31.4 x 9.4 x 22.8 inches _with stand
Weight	22" 5.2 kg_with stand 26" 6.8 kg_with stand 32" 9.6 kg_with stand	26" 6.5kg_with stand 32" 11.4kg_with stand
Brightness	500 nit	500 nit
Picture Enhacer	DNle (SX1 / X4)	DNle (Lola3)
Equalizer	5 Band	5 Band
Auto Volume Control	O	O
Surround Sound	Dolby Digital Plus	SRS TruSurround HD & Dolby Digital
Speaker Output	22" 3W / 26" 5W / 32" 10W	10W + 10W
PIP	O	O
Caption	O	O
Entertainment Mode	X	X
Game Mode	O	O
Energy Saving	O	O
Anynet*	O	O
Antenna	1	1

2-3. Detail Factory Option

※ If you replace the main board with new one, please change the factory option as well.
The options you must change are "Type".

• LC450 (SX1)

Model Name		LA22C450E1	LA26C450E1	LA32C450E1
Panel	Vendor	SEC	AUO	SEC
	CODE	BN07-00757A	BN07-00824A	BN07-00807A
	SPEC	LTF216AT01	T260XW04 V2	LTF320AP08
SMPS		IP Board (SEC)	BN44-00370A	BN44-00338A
Byte	Item	CHASSIS ASS'Y	BN91-05028E	BN91-05028A
		PBA ASSY CODE	BN94-03325E	BN94-03325A
0	Factory Reset	-	-	-
1	Type	22A6AH0C	26L6AH0C	32A6AH0C
2	Local Set	Depending on country	Depending on country	Depending on country
3	Model	LC450	LC450	LC450
4	Tuner	DRXKSEMCO	DRXKSEMCO	DRXKSEMCO
5	DDR	0	0	0
6	Light Effect	OFF	OFF	OFF
7	Ch Table	Depending on country	Depending on country	Depending on country
8	Country
9	Front Color	S-R-BLK	S-R-BLK	S-R-BLK

• LC450 (X4)

Model Name		LA22C450E1	LA26C450E1	LA32C450E1
Panel	Vendor	SEC	AUO	SEC
	CODE	BN07-00757A	BN07-00824A	BN07-00807A
	SPEC	LTF216AT01	T260XW04 V2	LTF320AP08
SMPS		IP Board (SEC)	BN44-00370A	BN44-00338A
Byte	Item	CHASSIS ASS'Y		
		PBA ASSY CODE		
0	Factory Reset	-	-	-
1	Type	22A6AH0C	26L6AH0C	32A6AH0C
2	Local Set	Depending on country	Depending on country	Depending on country
3	Model	LC450	LC450	LC450
4	Tuner	HTM6BXg	HTM6BXg	HTM6BXg
5	DDR	0	0	0
6	Light Effect	OFF	OFF	OFF
7	Ch Table	Depending on country	Depending on country	Depending on country
8	Country
9	Front Color	S-R-BLK	S-R-BLK	S-R-BLK

2. Product specifications

CHANNEL FREQUENCY TABLE

1. OUTPUT FREQUENCY : ANALOG fv:45.75MHz, fs:41.25MHz DIGITAL Fc:44MHz

2. TUNING STEP SIZE : FIRST PLL 250KHz SECOND PLL 62.5KHz

(Unit : MHz)

CH Number	AREA									
	ASIA W/EUROPE	BAND	CIS E/EUROPE	BAND	HONG KONG U/K	BAND	NZ/ INDONESIA	BAND	SOUTH AFRICA	BAND
C00	-	-	-	-	-	-	-	-	-	-
C01	46.25	VHF	49.75	VHF	49.75	VHF	44.25	VHF	-	-
C02	48.25	VHF	59.25	V-L	59.25	V-L	55.25	V-L	-	-
C03	55.25	V-L	77.25	V-L	77.25	V-L	62.25	V-L	-	-
C04	62.25	V-L	85.25	V-L	85.25	V-L	175.25	V-H	175.25	V-H
C05	175.25	V-H	93.25	VHF	93.25	VHF	182.25	V-H	183.25	V-H
C06	182.25	V-H	175.25	V-H	175.25	V-H	189.25	V-H	191.25	V-H
C07	189.25	V-H	183.25	V-H	183.25	V-H	196.25	V-H	199.25	V-H
C08	196.25	V-H	191.25	V-H	191.25	V-H	203.25	V-H	207.25	V-H
C09	203.25	V-H	199.25	V-H	199.25	V-H	210.25	V-H	215.25	V-H
C10	210.25	V-H	207.25	V-H	207.25	V-H	217.25	VHF	223.25	VHF
C11	217.25	VHF	215.25	V-H	215.25	V-H	224.25	VHF	231.25	VHF
C12	224.25	VHF	223.25	VHF	223.25	VHF	45.25	VHF	239.25	VHF
C13	53.75	VHF	53.75	VHF	45.75	VHF	-	-	247.25	VHF
C14	-	-	62.25	V-L	53.75	VHF	-	-	-	-
C15	82.25	V-L	82.25	V-L	61.75	V-L	-	-	-	-
C16	-	-	-	-	-	-	69.75	V-L	-	-
C17	183.75	V-H	183.75	V-H	95.75	VHF	-	-	-	-
C18	192.25	V-H	192.25	V-H	-	-	-	-	-	-
C19	201.25	V-H	-	-	201.25	V-H	-	-	-	-
C20	-	-	210.25	V-H	-	-	-	-	-	-
C21	471.25	UHF	471.25	UHF	471.25	UHF	471.25	UHF	471.25	UHF
C22	479.25	UHF	479.25	UHF	479.25	UHF	479.25	UHF	479.25	UHF
C23	487.25	UHF	487.25	UHF	487.25	UHF	487.25	UHF	487.25	UHF
C24	495.25	UHF	495.25	UHF	495.25	UHF	495.25	UHF	495.25	UHF
C25	503.25	UHF	503.25	UHF	503.25	UHF	503.25	UHF	503.25	UHF
C26	511.25	UHF	511.25	UHF	511.25	UHF	511.25	UHF	511.25	UHF
C27	519.25	UHF	519.25	UHF	519.25	UHF	519.25	UHF	519.25	UHF
C28	527.25	UHF	527.25	UHF	527.25	UHF	527.25	UHF	527.25	UHF
C29	535.25	UHF	535.25	UHF	535.25	UHF	535.25	UHF	535.25	UHF
C30	543.25	UHF	543.25	UHF	543.25	UHF	543.25	UHF	543.25	UHF
C31	551.25	UHF	551.25	UHF	551.25	UHF	551.25	UHF	551.25	UHF
C32	559.25	UHF	559.25	UHF	559.25	UHF	559.25	UHF	559.25	UHF
C33	567.25	UHF	567.25	UHF	567.25	UHF	567.25	UHF	567.25	UHF
C34	575.25	UHF	575.25	UHF	575.25	UHF	575.25	UHF	575.25	UHF
C35	583.25	UHF	583.25	UHF	583.25	UHF	583.25	UHF	583.25	UHF
C36	591.25	UHF	591.25	UHF	591.25	UHF	591.25	UHF	591.25	UHF
C37	599.25	UHF	599.25	UHF	599.25	UHF	599.25	UHF	599.25	UHF
C38	607.25	UHF	607.25	UHF	607.25	UHF	607.25	UHF	607.25	UHF
C39	615.25	UHF	615.25	UHF	615.25	UHF	615.25	UHF	615.25	UHF
C40	623.25	UHF	623.25	UHF	623.25	UHF	623.25	UHF	623.25	UHF
C41	631.25	UHF	631.25	UHF	631.25	UHF	631.25	UHF	631.25	UHF
C42	639.25	UHF	639.25	UHF	639.25	UHF	639.25	UHF	639.25	UHF
C43	647.25	UHF	647.25	UHF	647.25	UHF	647.25	UHF	647.25	UHF
C44	655.25	UHF	655.25	UHF	655.25	UHF	655.25	UHF	655.25	UHF
C45	663.25	UHF	663.25	UHF	663.25	UHF	663.25	UHF	663.25	UHF
C46	671.25	UHF	671.25	UHF	671.25	UHF	671.25	UHF	671.25	UHF
C47	679.25	UHF	679.25	UHF	679.25	UHF	679.25	UHF	679.25	UHF
C48	687.25	UHF	687.25	UHF	687.25	UHF	687.25	UHF	687.25	UHF
C49	695.25	UHF	695.25	UHF	695.25	UHF	695.25	UHF	695.25	UHF
C50	703.25	UHF	703.25	UHF	703.25	UHF	703.25	UHF	703.25	UHF
C51	711.25	UHF	711.25	UHF	711.25	UHF	711.25	UHF	711.25	UHF
C52	719.25	UHF	719.25	UHF	719.25	UHF	719.25	UHF	719.25	UHF
C53	727.25	UHF	727.25	UHF	727.25	UHF	727.25	UHF	727.25	UHF
C54	735.25	UHF	735.25	UHF	735.25	UHF	735.25	UHF	735.25	UHF
C55	743.25	UHF	743.25	UHF	743.25	UHF	743.25	UHF	743.25	UHF
C56	751.25	UHF	751.25	UHF	751.25	UHF	751.25	UHF	751.25	UHF
C57	759.25	UHF	759.25	UHF	759.25	UHF	759.25	UHF	759.25	UHF
C58	767.25	UHF	767.25	UHF	767.25	UHF	767.25	UHF	767.25	UHF
C59	775.25	UHF	775.25	UHF	775.25	UHF	775.25	UHF	775.25	UHF
C60	783.25	UHF	783.25	UHF	783.25	UHF	783.25	UHF	783.25	UHF

(Unit : MHz)

CH Number	AREA									
	ASIA W/EUROPE	BAND	CIS E/EUROPE	BAND	HONG KONG U/K	BAND	NZ/ INDONESIA	BAND	SOUTH AFRICA	BAND
C61	791.25	UHF	791.25	UHF	791.25	UHF	791.25	UHF	791.25	UHF
C62	799.25	UHF	799.25	UHF	799.25	UHF	799.25	UHF	799.25	UHF
C63	807.25	UHF	807.25	UHF	807.25	UHF	807.25	UHF	807.25	UHF
C64	815.25	UHF	815.25	UHF	815.25	UHF	815.25	UHF	815.25	UHF
C65	823.25	UHF	823.25	UHF	823.25	UHF	823.25	UHF	823.25	UHF
C66	831.25	UHF	831.25	UHF	831.25	UHF	831.25	UHF	831.25	UHF
C67	839.25	UHF	839.25	UHF	839.25	UHF	839.25	UHF	839.25	UHF
C68	847.25	UHF	847.25	UHF	847.25	UHF	847.25	UHF	847.25	UHF
C69	855.25	UHF	855.25	UHF	855.25	UHF	855.25	UHF	855.25	UHF
C70	-	-	-	-	-	-	53.75	-	53.75	-
C71	-	-	-	-	62.25	VHF	-	-	62.25	VHF
C72	-	-	-	-	82.25	V-L	82.25	V-L	82.25	V-L
C73	-	-	-	-	-	-	-	-	-	-
C74	69.75	V-L	-	-	-	-	183.25	V-H	-	-
C75	76.25	V-L	-	-	192.25	V-H	192.25	V-H	192.25	V-H
C76	83.25	V-L	-	-	201.25	V-H	201.25	V-H	201.25	V-H
C77	90.25	VHF	-	-	210.25	V-H	-	-	210.25	V-H
C78	97.25	VHF	217.25	VHF	217.25	VHF	-	-	217.25	VHF
C79	59.25	V-L	224.25	VHF	224.25	VHF	-	-	224.25	VHF
C80	-	-	93.25	VHF	-	-	-	-	-	-
C81	49.75	VHF	-	-	-	-	49.75	VHF	49.75	VHF
C82	-	-	-	-	-	-	59.25	V-L	59.25	V-L
C83	77.25	V-L	-	-	77.25	V-L	77.25	V-L	77.25	V-L
C84	85.25	V-L	-	-	85.25	V-L	85.25	V-L	85.25	V-L
C85	-	-	-	-	93.25	VHF	93.25	VHF	93.25	VHF
C86	-	-	-	-	-	-	-	-	-	-
C86	183.25	V-H	-	-	-	-	-	-	-	-
C86	191.25	V-H	-	-	-	-	191.25	V-H	-	-
C86	199.25	V-H	-	-	199.25	V-H	199.25	V-H	-	-
C86	207.25	V-H	-	-	207.25	V-H	207.25	V-H	-	-
C86	215.25	VHF	-	-	-	-	215.25	VHF	215.25	VHF
C86	223.25	VHF	-	-	-	-	223.25	VHF	223.25	VHF

2. Product specifications

(Unit : MHz)

CH Number	AREA					
	AUSTRALIA	BAND	CHINA	BAND	AMERICA	BAND
C00	46.25	VHF	-	-	-	-
C01	57.25	V-L	49.75	VHF	-	-
C02	64.25	V-L	57.75	V-L	55.25	V-L
C03	86.25	V-L	65.75	V-L	61.25	V-L
C04	95.25	VHF	77.25	V-L	67.25	V-L
C05	102.25	VHF	85.25	V-L	77.25	V-L
C06	175.25	V-H	168.25	VHF	83.25	V-L
C07	182.25	V-H	176.25	V-H	175.25	V-H
C08	189.25	V-H	184.25	V-H	181.25	V-H
C09	196.25	V-H	192.25	V-H	187.25	V-H
C10	209.25	V-H	200.25	V-H	193.25	V-H
C11	216.25	VHF	208.25	VHF	199.25	VHF
C12	224.25	VHF	216.25	VHF	205.25	VHF
C13	138.25	V-H	471.25	UHF	211.25	VHF
C14	203.25	V-H	479.25	UHF	471.25	UHF
C15	-	-	487.25	UHF	477.25	UHF
C16	-	-	495.25	UHF	483.25	UHF
C17	-	-	503.25	UHF	489.25	UHF
C18	-	-	511.25	UHF	495.25	UHF
C19	-	-	519.25	UHF	501.25	UHF
C20	-	-	527.25	UHF	507.25	UHF
C21	x	-	535.25	UHF	513.25	UHF
C22	x	-	543.25	UHF	519.25	UHF
C23	x	-	551.25	UHF	525.25	UHF
C24	x	-	559.25	UHF	531.25	UHF
C25	x	-	607.25	UHF	537.25	UHF
C26	x	-	615.25	UHF	543.25	UHF
C27	x	-	623.25	UHF	549.25	UHF
C28	527.25	UHF	631.25	UHF	555.25	UHF
C29	534.25	UHF	639.25	UHF	561.25	UHF
C30	541.25	UHF	647.25	UHF	567.25	UHF
C31	548.25	UHF	655.25	UHF	573.25	UHF
C32	555.25	UHF	663.25	UHF	579.25	UHF
C33	562.25	UHF	671.25	UHF	585.25	UHF
C34	569.25	UHF	679.25	UHF	591.25	UHF
C35	576.25	UHF	687.25	UHF	597.25	UHF
C36	583.25	UHF	695.25	UHF	603.25	UHF
C37	590.25	UHF	703.25	UHF	609.25	UHF
C38	597.25	UHF	711.25	UHF	615.25	UHF
C39	604.25	UHF	719.25	UHF	621.25	UHF
C40	611.25	UHF	727.25	UHF	627.25	UHF
C41	618.25	UHF	735.25	UHF	633.25	UHF
C42	625.25	UHF	743.25	UHF	639.25	UHF
C43	632.25	UHF	751.25	UHF	645.25	UHF
C44	639.25	UHF	759.25	UHF	651.25	UHF
C45	646.25	UHF	767.25	UHF	657.25	UHF
C46	653.25	UHF	775.25	UHF	663.25	UHF
C47	660.25	UHF	783.25	UHF	669.25	UHF
C48	667.25	UHF	791.25	UHF	675.25	UHF
C49	674.25	UHF	799.25	UHF	681.25	UHF
C50	681.25	UHF	807.25	UHF	687.25	UHF
C51	688.25	UHF	815.25	UHF	693.25	UHF

(Unit : MHz)

CH Number	AREA					
	AUSTRALIA	BAND	CHINA	BAND	AMERICA	BAND
C52	695.25	UHF	823.25	UHF	699.25	UHF
C53	702.25	UHF	831.25	UHF	705.25	UHF
C54	709.25	UHF	839.25	UHF	711.25	UHF
C55	716.25	UHF	847.25	UHF	717.25	UHF
C56	723.25	UHF	855.25	UHF	723.25	UHF
C57	730.25	UHF	863.25	UHF	729.25	UHF
C58	737.25	UHF	-	-	735.25	UHF
C59	744.25	UHF	-	-	741.25	UHF
C60	751.25	UHF	-	-	747.25	UHF
C61	758.25	UHF	-	-	753.25	UHF
C62	765.25	UHF	-	-	759.25	UHF
C63	772.25	UHF	-	-	765.25	UHF
C64	779.25	UHF	-	-	771.25	UHF
C65	786.25	UHF	567.25	UHF	777.25	UHF
C66	793.25	UHF	575.25	UHF	783.25	UHF
C67	800.25	UHF	583.25	UHF	789.25	UHF
C68	807.25	UHF	591.25	UHF	795.25	UHF
C69	814.25	UHF	599.25	UHF	801.25	UHF
C70	53.75	-	-	-	807.25	UHF
C71	62.25	VHF	-	-	813.25	UHF
C72	82.25	V-L	-	-	819.25	UHF
C73	-	-	-	-	825.25	UHF
C74	183.25	-	-	-	831.25	UHF
C75	192.25	V-H	-	-	837.25	UHF
C76	201.25	V-H	-	-	843.25	UHF
C77	-	V-H	-	-	849.25	UHF
C78	-	VHF	-	-	855.25	UHF
C79	-	VHF	-	-	861.25	UHF
C80	-	-	-	-	867.25	UHF
C81	49.75	VHF	-	-	873.25	UHF
C82	59.25	V-L	-	-	879.25	UHF
C83	77.25	V-L	-	-	885.25	UHF
C84	85.25	V-L	-	-	-	-
C85	93.25	VHF	-	-	-	-
C86	-	-	-	-	-	-
C86	-	-	-	-	-	-
C86	191.25	-	-	-	-	-
C86	199.25	-	-	-	-	-
C86	207.25	-	-	-	-	-
C86	215.25	VHF	-	-	-	-
C86	223.25	VHF	-	-	-	-

2. Product specifications

Cable CHANNEL

(Unit : MHz)

CH Number	AREA									
	ASIA W/EUROPE	BAND	CIS E/EUROPE	BAND	HONG KONG U/K	BAND	NZ/ INDONESIA	BAND	SOUTH AFRICA	BAND
S01	105.25	VHF	103.25	VHF	103.25	VHF	105.25	VHF	105.25	VHF
S02	112.25	VHF	111.25	VHF	111.25	VHF	112.25	VHF	112.25	VHF
S03	119.25	VHF	119.25	VHF	119.25	VHF	119.25	VHF	119.25	VHF
S04	126.25	VHF	127.25	VHF	127.25	VHF	126.25	VHF	126.25	VHF
S05	133.25	VHF	135.25	VHF	135.25	VHF	133.25	VHF	133.25	VHF
S06	140.25	VHF	143.25	VHF	143.25	VHF	140.25	VHF	140.25	VHF
S07	147.25	VHF	151.25	VHF	151.25	VHF	147.25	VHF	147.25	VHF
S08	154.25	VHF	159.25	VHF	159.25	VHF	154.25	VHF	154.25	VHF
S09	161.25	VHF	167.25	VHF	167.25	VHF	161.25	VHF	161.25	VHF
S10	168.25	VHF	231.25	VHF	231.25	VHF	168.25	VHF	168.25	VHF
S11	231.25	VHF	239.25	VHF	239.25	VHF	231.25	VHF	231.25	VHF
S12	238.25	VHF	247.25	VHF	247.25	VHF	238.25	VHF	238.25	VHF
S13	245.25	VHF	253.25	VHF	253.25	VHF	245.25	VHF	245.25	VHF
S14	252.25	VHF	263.25	VHF	263.25	VHF	252.25	VHF	252.25	VHF
S15	259.25	VHF	271.25	VHF	271.25	VHF	259.25	VHF	259.25	VHF
S16	266.25	VHF	279.25	VHF	279.25	VHF	266.25	VHF	266.25	VHF
S17	273.25	VHF	287.25	VHF	287.25	VHF	273.25	VHF	273.25	VHF
S18	280.25	VHF	295.25	VHF	295.25	VHF	280.25	VHF	280.25	VHF
S19	287.25	VHF	303.25	UHF	303.25	UHF	287.25	VHF	287.25	VHF
S20	294.25	VHF	-	-	-	-	294.25	VHF	294.25	VHF
S21	303.25	UHF	-	-	-	-	303.25	UHF	303.25	UHF
S22	311.25	UHF	311.25	UHF	311.25	UHF	311.25	UHF	311.25	UHF
S23	319.25	UHF	319.25	UHF	319.25	UHF	319.25	UHF	319.25	UHF
S24	327.25	UHF	327.25	UHF	327.25	UHF	327.25	UHF	327.25	UHF
S25	335.25	UHF	335.25	UHF	335.25	UHF	335.25	UHF	335.25	UHF
S26	343.25	UHF	343.25	UHF	343.25	UHF	343.25	UHF	343.25	UHF
S27	351.25	UHF	351.25	UHF	351.25	UHF	351.25	UHF	351.25	UHF
S28	359.25	UHF	359.25	UHF	359.25	UHF	359.25	UHF	359.25	UHF
S29	367.25	UHF	367.25	UHF	367.25	UHF	367.25	UHF	367.25	UHF
S30	375.25	UHF	375.25	UHF	375.25	UHF	375.25	UHF	375.25	UHF
S31	383.25	UHF	383.25	UHF	383.25	UHF	383.25	UHF	383.25	UHF
S32	391.25	UHF	391.25	UHF	391.25	UHF	391.25	UHF	391.25	UHF
S33	399.25	UHF	399.25	UHF	399.25	UHF	399.25	UHF	399.25	UHF
S34	407.25	UHF	407.25	UHF	407.25	UHF	407.25	UHF	407.25	UHF
S35	415.25	UHF	415.25	UHF	415.25	UHF	415.25	UHF	415.25	UHF
S36	423.25	UHF	423.25	UHF	423.25	UHF	423.25	UHF	423.25	UHF
S37	431.25	UHF	431.25	UHF	431.25	UHF	431.25	UHF	431.25	UHF
S38	439.25	UHF	439.25	UHF	439.25	UHF	439.25	UHF	439.25	UHF
S39	447.25	UHF	447.25	UHF	447.25	UHF	447.25	UHF	447.25	UHF
S40	455.25	UHF	455.25	UHF	455.25	UHF	455.25	UHF	455.25	UHF
S41	463.25	UHF	463.25	UHF	463.25	UHF	463.25	UHF	463.25	UHF

(Unit : MHz)

CH Number	AREA					
	AUSTRALIA	BAND	CHINA	BAND	AMERICA	BAND
S01	105.25	VHF	112.25	VHF	73.25	VHF
S02	112.25	VHF	120.25	VHF	55.25	VHF
S03	119.25	VHF	128.25	VHF	61.25	VHF
S04	126.25	VHF	136.25	VHF	67.25	VHF
S05	133.25	VHF	144.25	VHF	77.25	VHF
S06	140.25	VHF	152.25	VHF	83.25	VHF
S07	147.25	VHF	160.25	VHF	175.25	VHF
S08	154.25	VHF	224.25	VHF	181.25	VHF
S09	161.25	VHF	232.25	VHF	187.25	VHF
S10	168.25	VHF	240.25	VHF	193.25	VHF
S11	231.25	VHF	248.25	VHF	199.25	VHF
S12	238.25	VHF	256.25	VHF	205.25	VHF
S13	245.25	VHF	264.25	VHF	211.25	VHF
S14	252.25	VHF	272.25	VHF	121.25	VHF
S15	259.25	VHF	280.25	VHF	127.25	VHF
S16	266.25	VHF	288.25	VHF	133.25	VHF
S17	273.25	VHF	296.25	VHF	139.25	VHF
S18	280.25	VHF	304.25	UHF	145.25	VHF
S19	287.25	VHF	312.25	UHF	151.25	VHF
S20	294.25	VHF	320.25	UHF	157.25	VHF
S21	303.25	UHF	328.25	UHF	163.25	VHF
S22	311.25	UHF	336.25	UHF	169.25	VHF
S23	319.25	UHF	344.25	UHF	217.25	VHF
S24	327.25	UHF	352.25	UHF	223.25	VHF
S25	335.25	UHF	360.25	UHF	229.25	VHF
S26	343.25	UHF	368.25	UHF	235.25	VHF
S27	351.25	UHF	376.25	UHF	241.25	VHF
S28	359.25	UHF	384.25	UHF	247.25	VHF
S29	367.25	UHF	392.25	UHF	253.25	VHF
S30	375.25	UHF	400.25	UHF	259.25	VHF
S31	383.25	UHF	408.25	UHF	265.25	VHF
S32	391.25	UHF	416.25	UHF	271.25	VHF
S33	399.25	UHF	424.25	UHF	277.25	VHF
S34	407.25	UHF	432.25	UHF	283.25	VHF
S35	415.25	UHF	440.25	UHF	289.25	VHF
S36	423.25	UHF	448.25	UHF	295.25	VHF
S37	431.25	UHF	456.25	UHF	301.25	UHF
S38	439.25	UHF	x	x	307.25	UHF
S39	447.25	UHF	x	x	313.25	UHF
S40	455.25	UHF	x	x	319.25	UHF
S41	463.25	UHF	x	x	325.25	UHF
S42					331.25	UHF
S43					337.25	UHF
S44					343.25	UHF
S45					349.25	UHF
S46					355.25	UHF
S47					361.25	UHF
S48					367.25	UHF
S49					373.25	UHF
S50					379.25	UHF
S51					385.25	UHF
S52					391.25	UHF
S53					397.25	UHF
S54					403.25	UHF
S55					409.25	UHF
S56					415.25	UHF
S57					421.25	UHF
S58					427.25	UHF
S59					433.25	UHF
S60					439.25	UHF
S61					445.25	UHF
S62					451.25	UHF
S63					457.25	UHF
S64					463.25	UHF
S65					469.25	UHF

2. Product specifications

(Unit : MHz)

CH Number	AREA					
	AUSTRALIA	BAND	CHINA	BAND	AMERICA	BAND
S66					475.25	UHF
S67					481.25	UHF
S68					487.25	UHF
S69					493.25	UHF
S70					499.25	UHF
S71					505.25	UHF
S72					511.25	UHF
S73					517.25	UHF
S74					523.25	UHF
S75					529.25	UHF
S76					535.25	UHF
S77					541.25	UHF
S78					547.25	UHF
S79					553.25	UHF
S80					559.25	UHF
S81					565.25	UHF
S82					571.25	UHF
S83					577.25	UHF
S84					583.25	UHF
S85					589.25	UHF
S86					595.25	UHF
S87					601.25	UHF
S88					607.25	UHF
S89					613.25	UHF
S90					619.25	UHF
S91					625.25	UHF
S92					631.25	UHF
S93					637.25	UHF
S94					643.25	UHF
S95					91.25	VHF
S96					97.25	VHF
S97					103.25	VHF
S98					109.25	VHF
S99					115.25	VHF



CATV CH mark (A row) : China area : attach 'Z'

besides area : attach 'S'

For example) China : Z10

besides area : S10

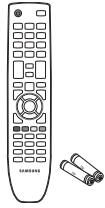
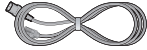
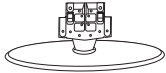
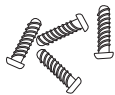
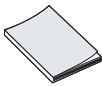
2-4. Accessories

Product	Description	Code. No	Remark
	Remote Control & Batteries (AAA x 2)	BN59-01010A	Samsung Electronics Service center
	Power Cord	Depending On Country	
	Stand	22" BN96-12739A 26" BN96-12869A 32" BN96-12870A	
	Screw (for the stand - M4, L6)	6002-001294	
	Owner's Instructions	BN68-02684A	
	Warranty Card / Registration Card / Safety Guide Manual (Not available in all locations)		
	FM Transmitter	BN59-00994A	

4. Troubleshooting

4-1. Troubleshooting

4-1-1. Previous check

1. Check the various cable connections first.
 - Check to see if there is a burnt or damaged cable.
 - Check to see if there is a disconnected or loose cable connection.
 - Check to see if the cables are connected according to the connection diagram.
2. Check the power input to the Main Board.

4-1-1. No Power (SX1)

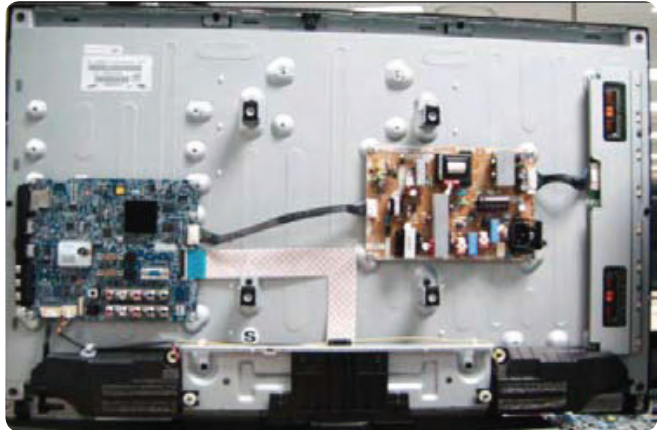
Symptom	<ul style="list-style-type: none"> - The LEDs on the front panel do not work when connecting the power cord. - The SMPS relay does not work when connecting the power cord. - The units appears to be dead.
Major checkpoints	<p>The IP relay or the LEDs on the front panel does not work when connecting the power cord if the cables are improperly connected or the Main Board or SMPS is not functioning. In this case, check the following:</p> <ul style="list-style-type: none"> - Check the internal cable connection status inside the unit. - Check the fuses of each part. - Check the output voltage of SMPS. - Replace the Main Board.
Diagnostics	<div style="text-align: center;">  </div> <pre> graph TD Q1[LAMP off, power indicator LED red color?] -- No --> A1[Check a connection a power cable.] Q1 -- Yes --> Q2[Does proper DC5V appear at pin 4 of CN210_18P?] Q2 -- No --> A2[Change a Assy PCB Power.] Q2 -- Yes --> Q3[Does proper DC A3.3V appear at BD215?] Q3 -- No --> A3[Check a IC201. Change a main PCB ass'y.] Q3 -- Yes --> Q4[Does proper DC 3.3V, 1.1V appear at BD216, BD233?] Q4 -- No --> A4[Check a IC203, IC204. Change a main PCB ass'y.] Q4 -- Yes --> Q5[A power is supplied to set?] </pre>
Caution	<p>Make sure to disconnect the power before working on the IP board.</p>

4-1-2. No Video (Analog PC signal) (SX1)

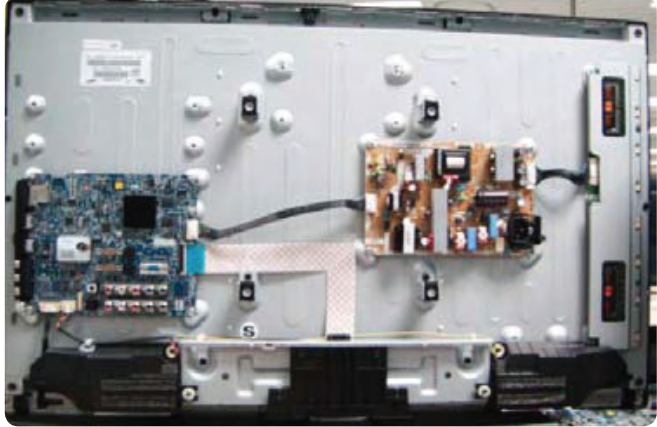
Symptom	<ul style="list-style-type: none"> - Audio is normal but no picture is displayed on the screen.
Major checkpoints	<ul style="list-style-type: none"> - Check the PC source. - Check the IC1102(SX1). - This may happen when the LVDS cable connecting the Main Board and the Panel is disconnected.
Diagnostics	 <pre> graph TD A[Power Indicator is off. Lamp on, no video.] -- Yes --> B[Check a PC source and check the connection of DSUB cable?] B -- No --> C[Input a analog PC signal and connected cable(DPMS).] B -- Yes --> D[Does the signal appear at R581(R), R582(G), R583(B) of IC1102?] D -- No --> E[PC cable. Change a PC. cable. Change a main PCB ass'y.] D -- Yes --> F[Does the digital data appear at the output of LVDS Cable?] F -- No --> G[IC1102. Change a main PCB ass'y.] F -- Yes --> H[Check a LVDS cable? Replace a lcd panel?] H -- Yes --> I[Please, Call to Samsung Co. LTD.] </pre>
Caution	<p>Make sure to disconnect the power before working on the IP board.</p>

WAVEFORMS

1 2 PC input (V-sink , H-sink , R/G/B)

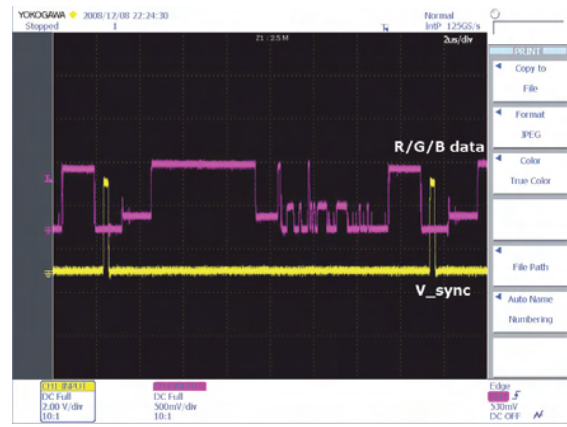
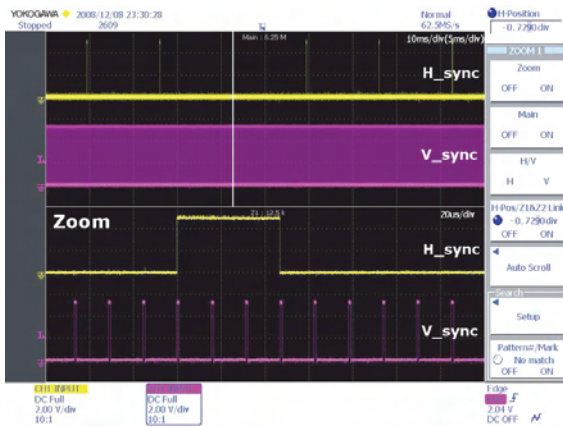

3 LVDS output

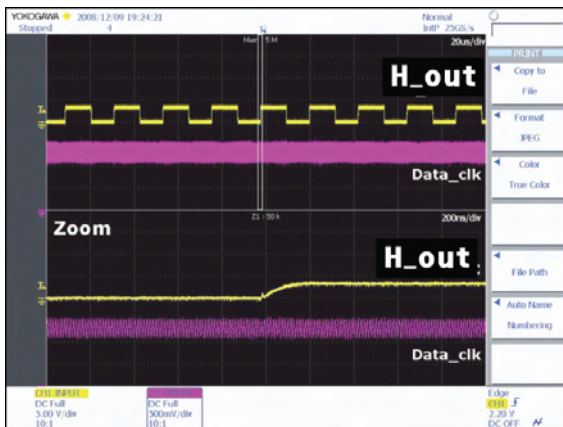

4-1-3. No Video (HDMI - Digital Signal) (SX1)

Symptom	- Audio is normal but no picture is displayed on the screen.
Major checkpoints	<ul style="list-style-type: none"> - Check the HDMI source. - Check the IC1102(SX1) , Check the HDMI switch - This may happen when the LVDS cable connecting the Main Board and the Panel is disconnected.

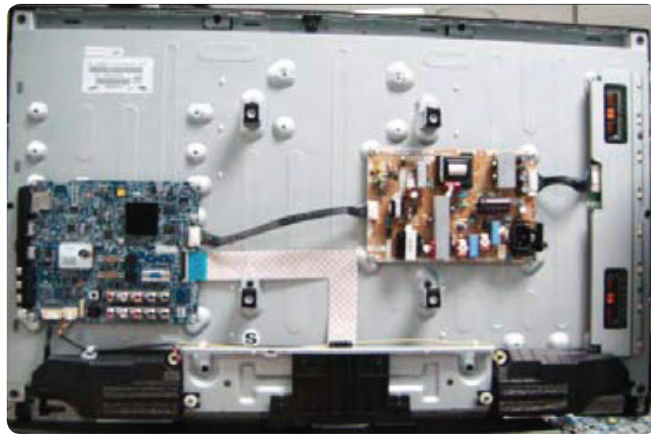

Diagnostics

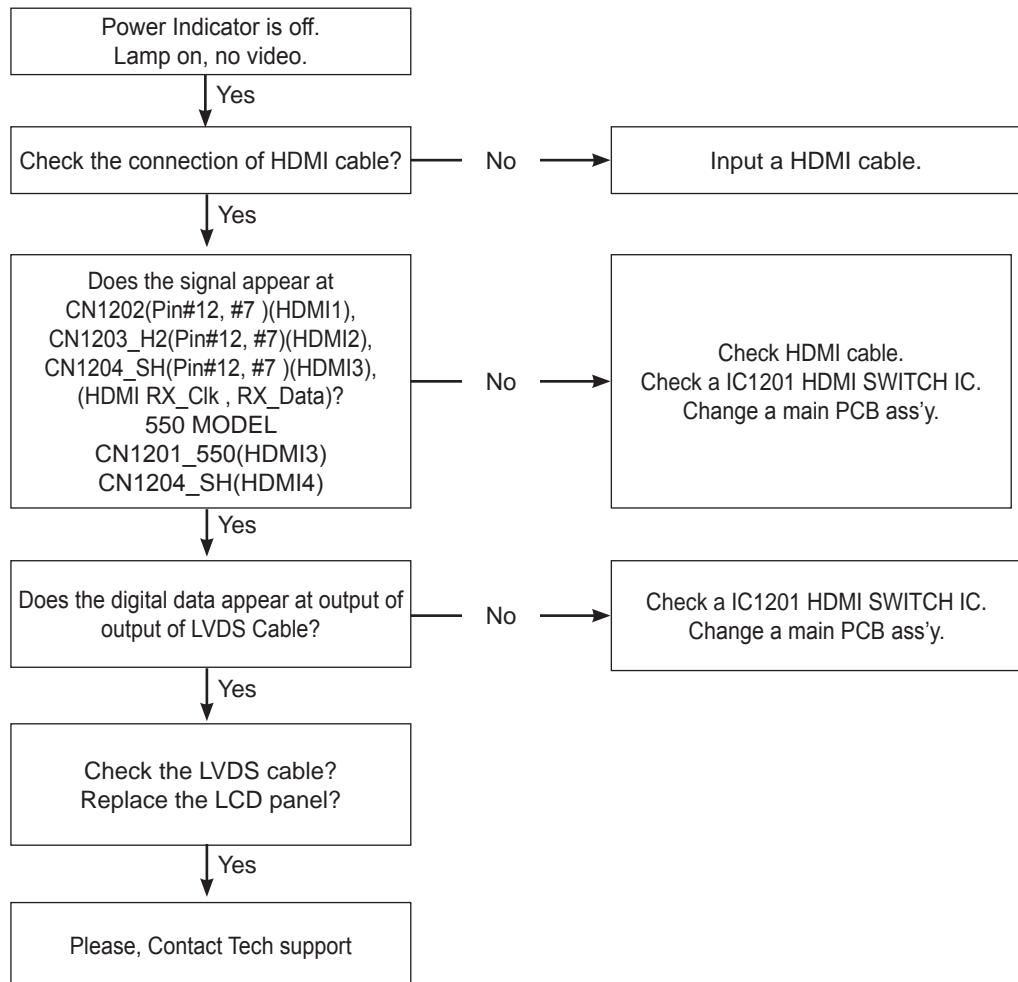

Caution	Make sure to disconnect the power before working on the IP board.
---------	---

WAVEFORMS

1 HDMI input (RX_Data, RX_Clk)

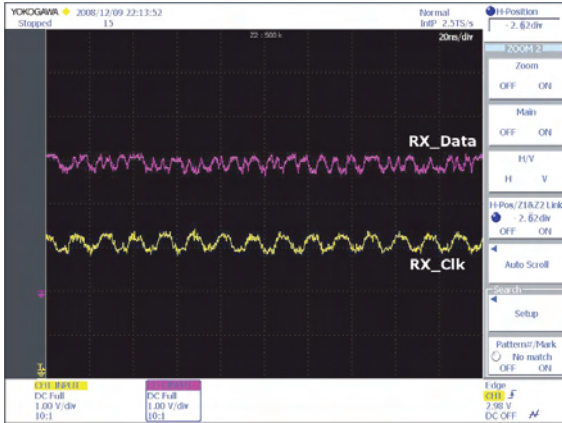

2 LVDS output

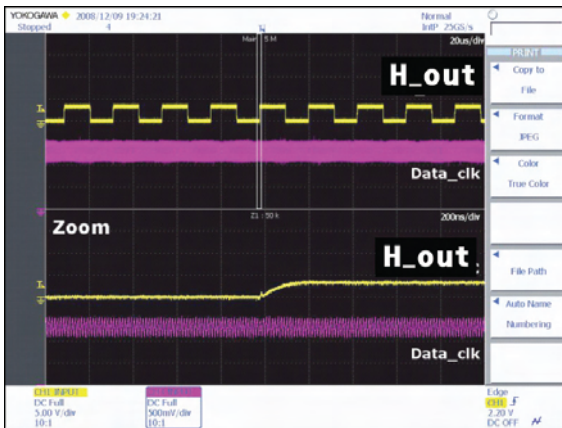

4-1-4. No Video (Tuner_CVBS) (SX1)

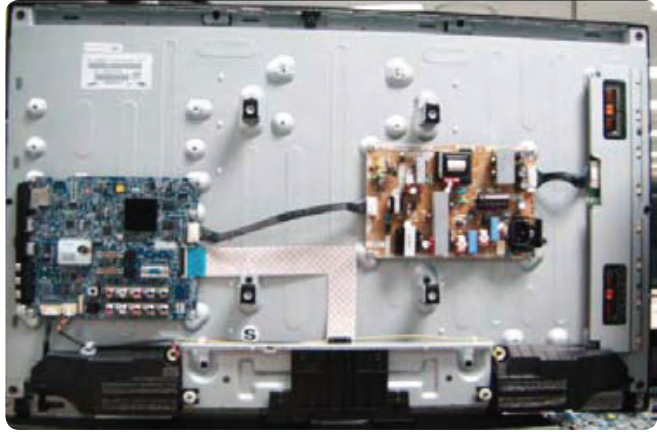
Symptom	<ul style="list-style-type: none"> - Audio is normal but no picture is displayed on the screen.
Major checkpoints	<ul style="list-style-type: none"> - Check the Tuner CVBS source - Check the M-star - This may happen when the LVDS cable connecting the Main Board and the Panel is disconnected.
Diagnostics	 <pre> graph TD A[Power Indicator is off. Lamp on, no picture.] -- No --> B[Connect the RF cable and check RF signal.] A -- Yes --> C[Does the signal appear #43 of IC801? (DRXK 43PIN CVBS_TP)] C -- No --> D[Check a B+ voltage (IC801 DRXK IC) 3.3V,1.25V. Change a main PCB ass'y.] C -- Yes --> E[Does the Signal appear at R505 of IC1102?] E -- No --> F[Change a main PCB ass'y.] E -- Yes --> G[Check the LVDS cable? Replace the LCD panel?] G -- Yes --> H[Please, Call to Samsung Co. LTD.] </pre>
Caution	<p>Make sure to disconnect the power before working on the IP board.</p>

WAVEFORMS

1 CVBS OUT (Grey Bar)

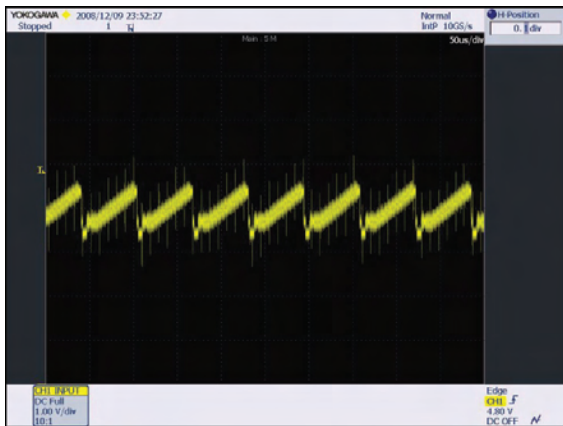

2 LVDS output

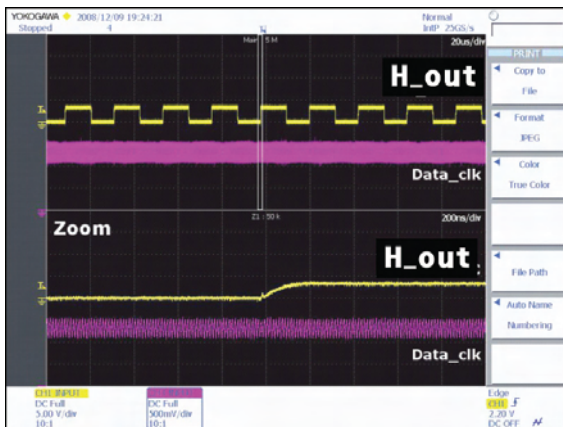

4-1-5. No Picture (Video_CVBS) (SX1)

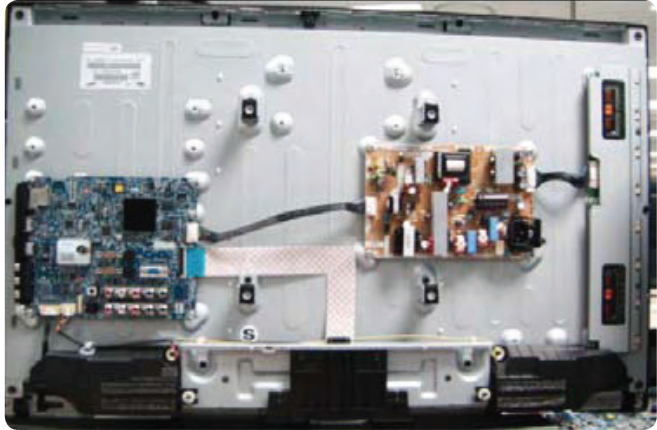
Symptom	<ul style="list-style-type: none"> - Audio is normal but no picture is displayed on the screen.
Major checkpoints	<ul style="list-style-type: none"> - Check the Video Source - Check the M-star - This may happen when the LVDS cable connecting the Main Board and the Panel is disconnected.
Diagnostics	 <pre> graph TD A[Power Indicator is off. Lamp on, no picture.] -- No --> B[Check a A/V cable and video signal.] A -- Yes --> C[Does the signal appear at C507, C509 of IC1102?] C -- No --> D[Check a connection harness.] C -- Yes --> E[Check a LVDS cable ? Replce/cd panel?] E -- Yes --> F[Please, Call to Samsung Co. LTD.] </pre>
Caution	<p>Make sure to disconnect the power before working on the IP board.</p>

WAVEFORMS

1 LVDS output

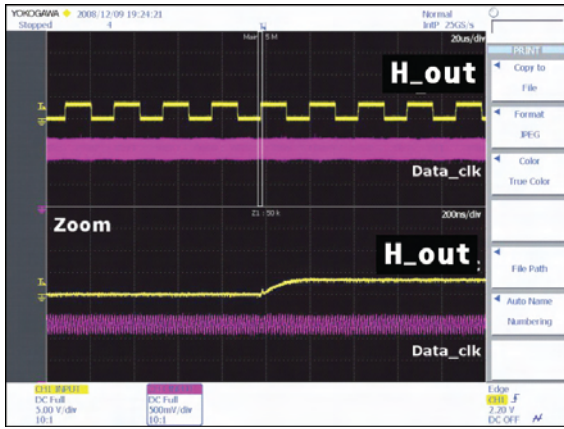

4-1-6. No Sound (SX1)

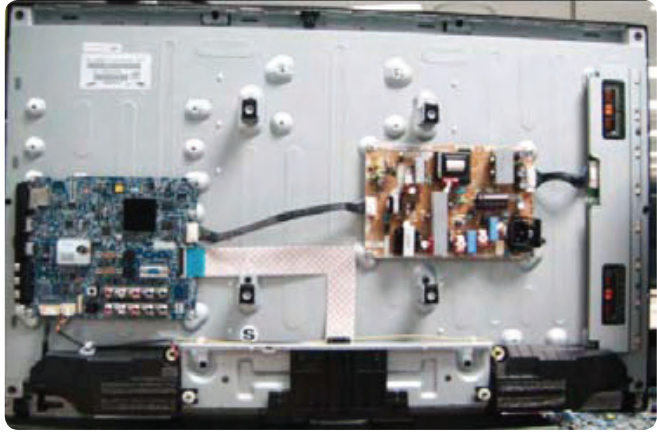
Symptom	<ul style="list-style-type: none"> - Video is normal but there is no sound..
Major checkpoints	<ul style="list-style-type: none"> - When the speaker connectors are disconnected or damaged. - When the sound processing part of the Main Board is not functioning. - Speaker defect.
Diagnostics	 <pre> graph TD A[Picture is display, no sound.] -- No --> B[Connect a sound cable. control a volume.] A -- Yes --> C[Does the signal appear at R832, R833, R834 (I2S_LRCLK, I2S_BCLK, I2S_DATA) of IC801?] C -- No --> D[Check a connection harness and headphone jack./Side AV. Check Sound Processor IC1102(SX1).] C -- Yes --> E[Check the B 3.3V, B 1.2V of IC801?] E -- No --> F[Change a DRXK IC IC801. Change a main PCB ass'y.] E -- Yes --> G[Does the signal appear at L1465_F, L1466_F near IC1401?] G -- No --> H[Change a DRXK IC IC1401. Change a main PCB ass'y.] G -- Yes --> I[Replace the speaker ass'y?] </pre>
Caution	Make sure to disconnect the power before working on the IP board.

WAVEFORMS

1 I2S Data



2 Speaker out

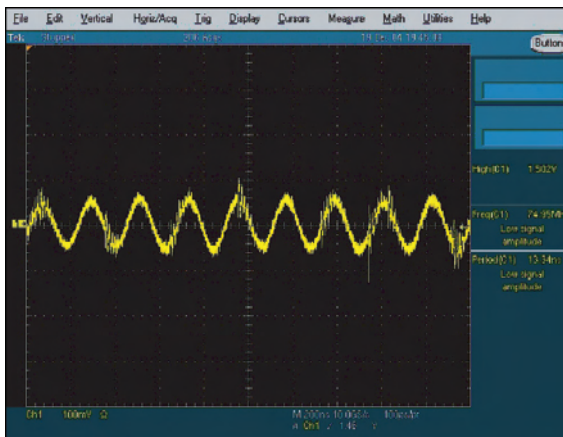

4-1-1. No Power (X4)

Symptom	<ul style="list-style-type: none"> - The LEDs on the front panel do not work when connecting the power cord. - The SMPS relay does not work when connecting the power cord. - The units appears to be dead.
Major checkpoints	<p>The IP relay or the LEDs on the front panel does not work when connecting the power cord if the cables are improperly connected or the Main Board or SMPS is not functioning.</p> <p>In this case, check the following:</p> <ul style="list-style-type: none"> - Check the internal cable connection status inside the unit. - Check the fuses of each part. - Check the output voltage of SMPS. - Replace the Main Board.

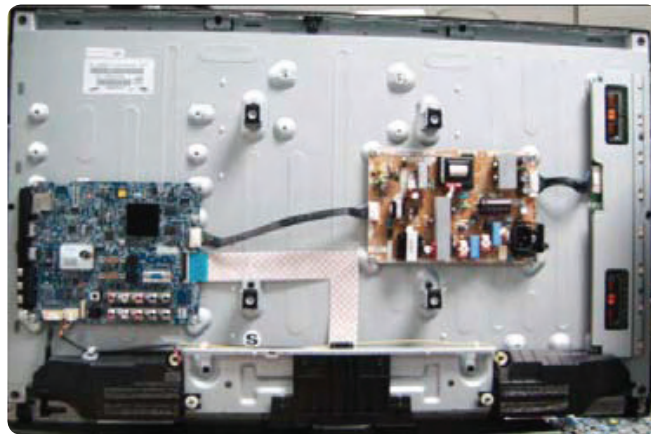

Diagnostics

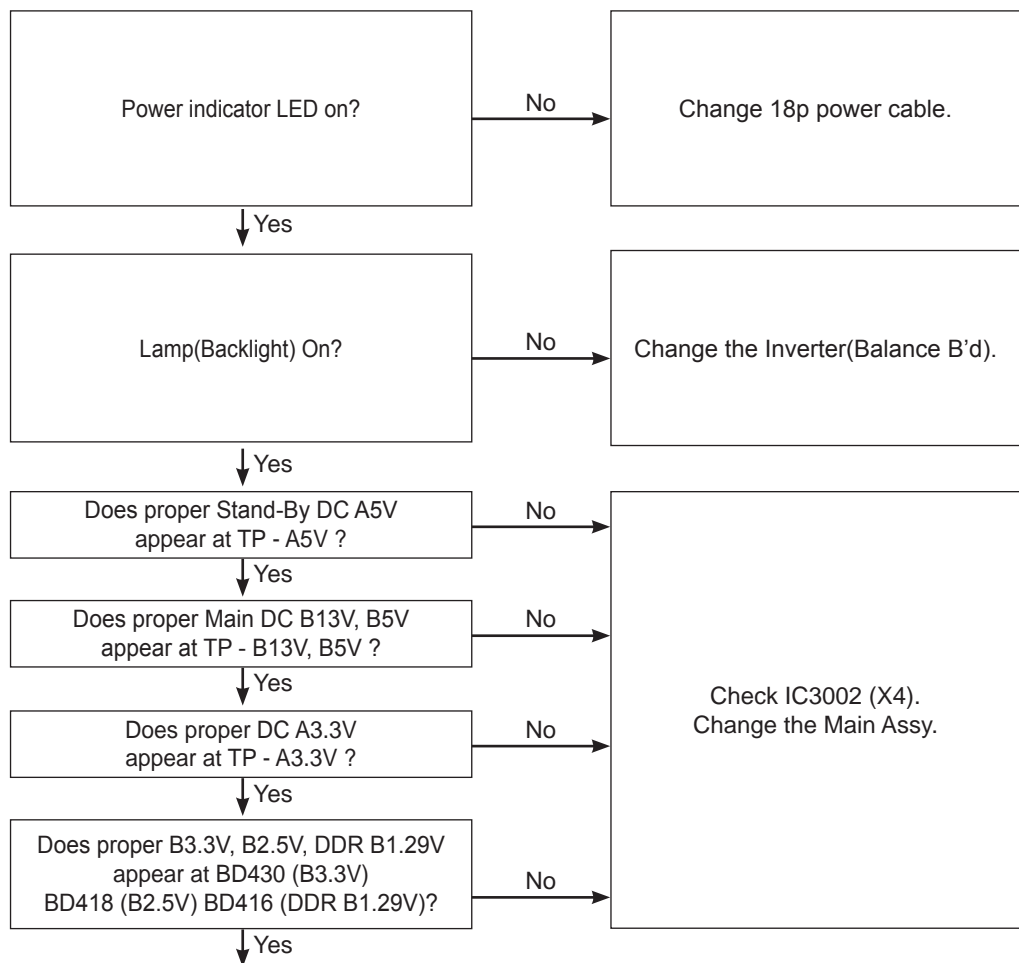

4. Troubleshooting

Diagnostics

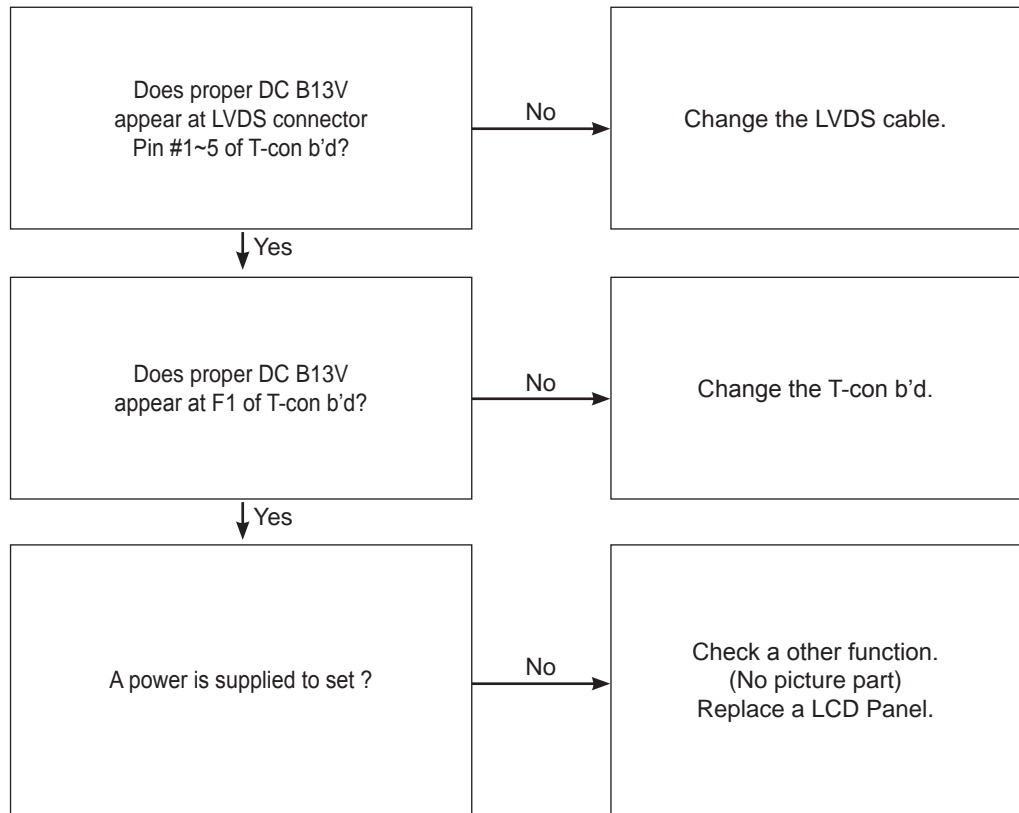

Caution

Make sure to disconnect the power before working on the IP board.

4-1-2. No Video_Analog PC signal (X4)

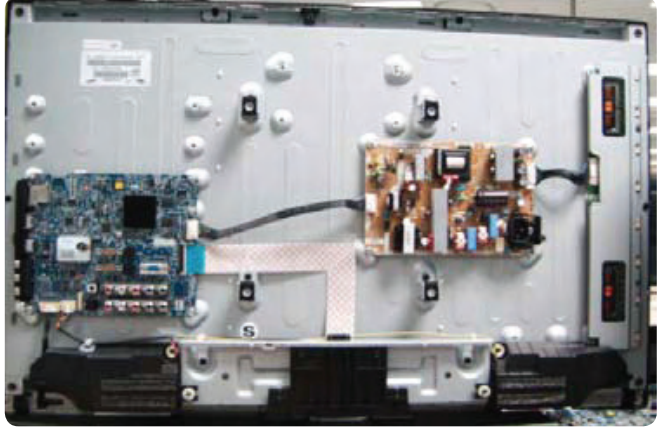
Symptom	<ul style="list-style-type: none"> - Audio is normal but no picture is displayed on the screen.
Major checkpoints	<ul style="list-style-type: none"> - Check the PC source - Check the Arsenal, Check the Chelsea. - This may happen when the LVDS cable connecting the Main Board and the Panel is disconnected.
Diagnostics	 <pre> graph TD Q1[Power indicator LED is off. Lamp(Backlight) on, no video ?] -- No --> A1[Check a set in the 'Stand-by mode'. or 'DPMS mode'.] Q1 -- Yes --> Q2[Check the PC source and check the connection of D-SUB ?] Q2 -- No --> A2[Input the analog PC signal properly.] Q2 -- Yes --> Q3[Does the signal appear at TP - PC_R, PC_G, PC_B, PC_HS, PC_VS (R, G, B, H, V) ?] Q3 -- No --> A3[Check CN901, PC cable. Change the Main Assy] Q3 -- Yes --> Q4[Does the digital data appear at TP-E_TXCLK+, E_TXCLK-, O_TXCLK+, O_TXCLK- ?] Q4 -- No --> A4[Check IC3002 (X4). Change the Main Assy.] Q4 -- Yes --> Q5[Check the LVDS cable? Check the T-Con B'd? Replace the LCD panel?] Q5 -- No --> A5[Please, Contact Tech support.] </pre>
Caution	Make sure to disconnect the power before working on the IP board.

■ WAVEFORMS

1 PC input (V-sink , H-sink , R/G/B)

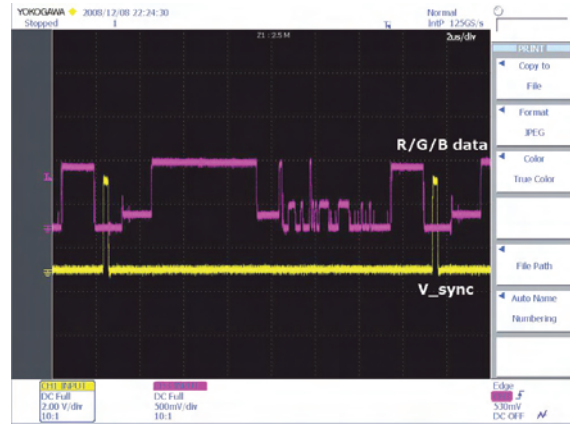
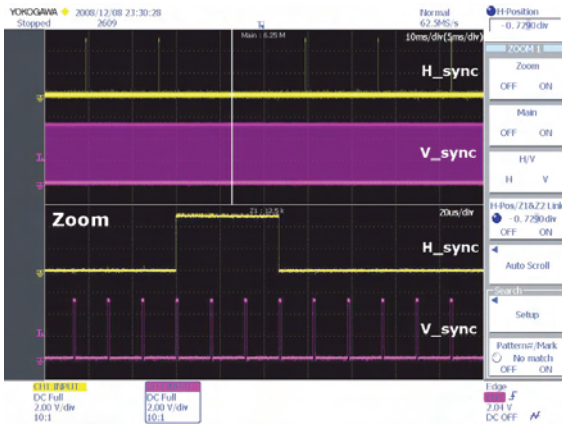

2 LVDS output

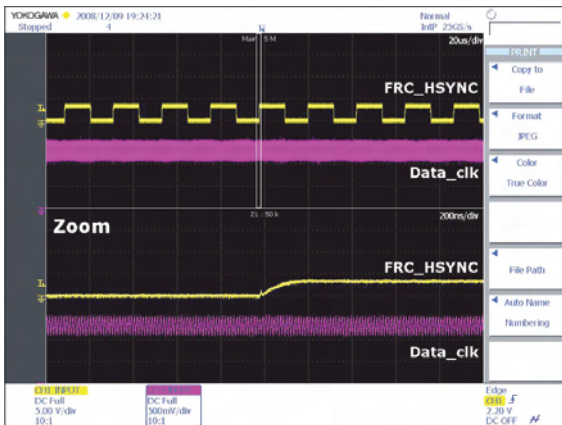

4-1-3. No video_HDMI1, 2, 3, 4 - Digital signal (X4)

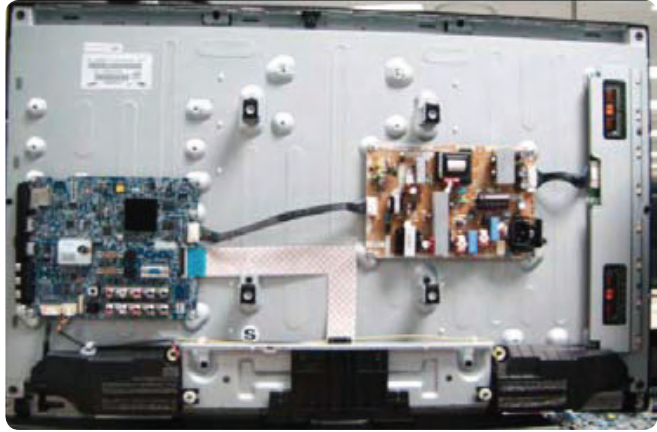
Symptom	<ul style="list-style-type: none"> - Audio is normal but no picture is displayed on the screen.
Major checkpoints	<ul style="list-style-type: none"> - Check the HDMI source. - Check the HDMI switch, Check the Chelsea. - This may happen when the LVDS cable connecting the Main Board and the Panel is disconnected.
Diagnostics	 <pre> graph TD Q1[Power indicator LED is off. Lamp(Backlight) on, no video ?] -- No --> A1[Check a set in the 'Stand-by mode'.] Q1 -- Yes --> Q2[Check the HDMI source and check the connection of HDMI cable ?] Q2 -- No --> A2[Input the HDMI signal properly.] Q2 -- Yes --> Q3[Does the signal appear at CN1302 (Pin#12, #7) (HDMI1) CN1303_H2 (Pin#12, #7) (HDMI2) CN1301_550 (Pin#12, #7) (HDMI3) CN1304_SH (Pin#12, #7) (HDMI4) (HDMI RX_Clk , RX_Data) ?] Q3 -- No --> A3[Check CN1302, CN1303_H2, CN1301_550, CN1304_SH. Check HDMI cable. Change the Main Assy.] Q3 -- Yes --> Q4[Does the digital data appear at TP-E_TXCLK+, E_TXCLK-, O_TXCLK+, O_TXCLK- ?] Q4 -- No --> A4[Check IC3002 (X4). Change the Main Assy.] Q4 -- Yes --> Q5[Check the LVDS cable? Check the T-Con B'd? Replace the LCD panel?] Q5 -- No --> A5[Please, Contact Tech support.] </pre>
Caution	Make sure to disconnect the power before working on the IP board.

■ WAVEFORMS

3 HDMI input (RX_Data, RX_Clk)

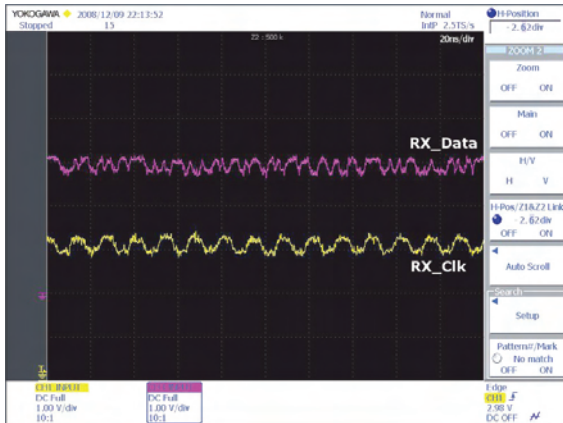

2 LVDS output

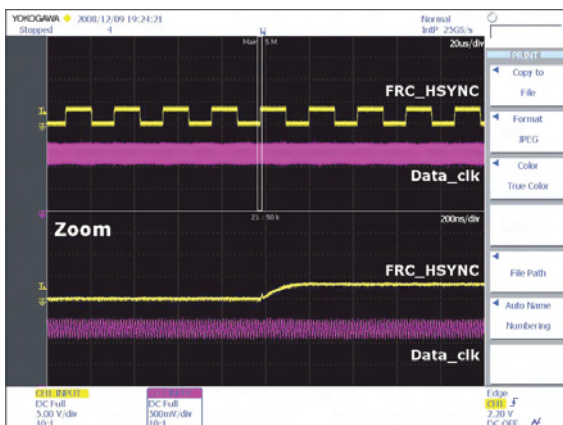

4-1-4. No Video_Tuner - CVBS (X4)

Symptom	- Audio is normal but no picture is displayed on the screen.
Major checkpoints	<ul style="list-style-type: none"> - Check the Tuner CVBS source. - Check the Tuner, Check the Chelsea. - This may happen when the LVDS cable connecting the Main Board and the Panel is disconnected.

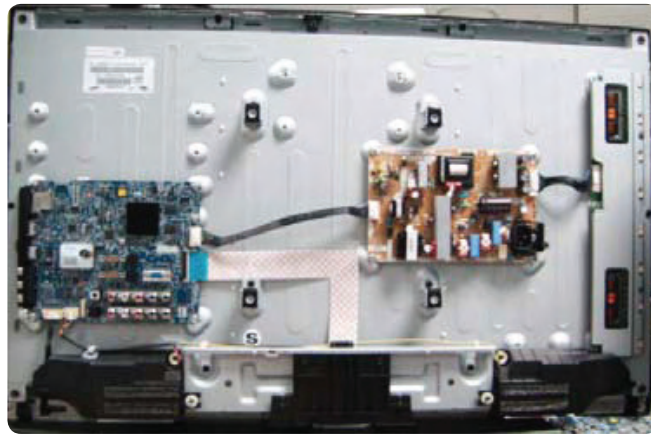

Diagnostics

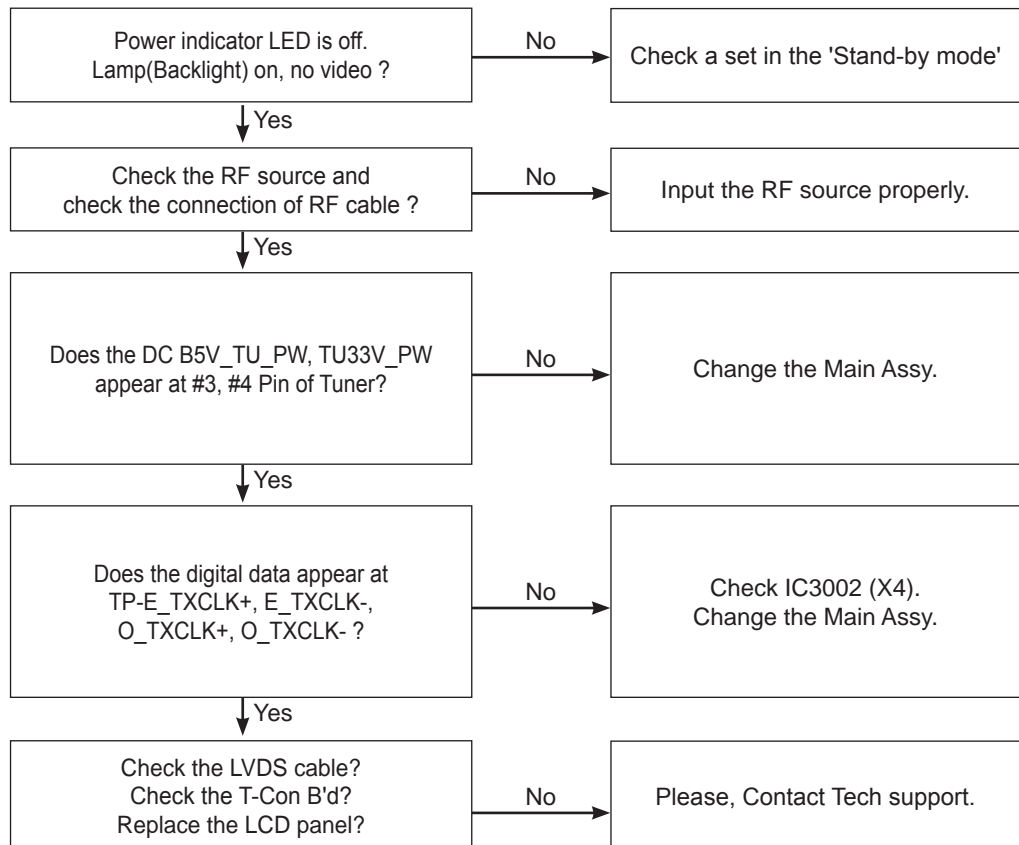

Caution	Make sure to disconnect the power before working on the IP board.
---------	---

■ WAVEFORMS

2 LVDS output

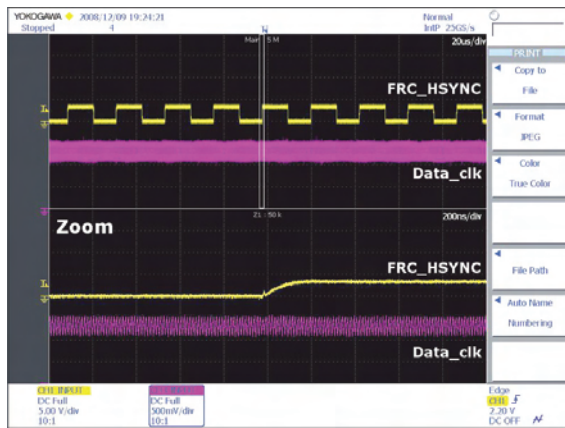

4-1-5. No Video_Video CVBS (X4)

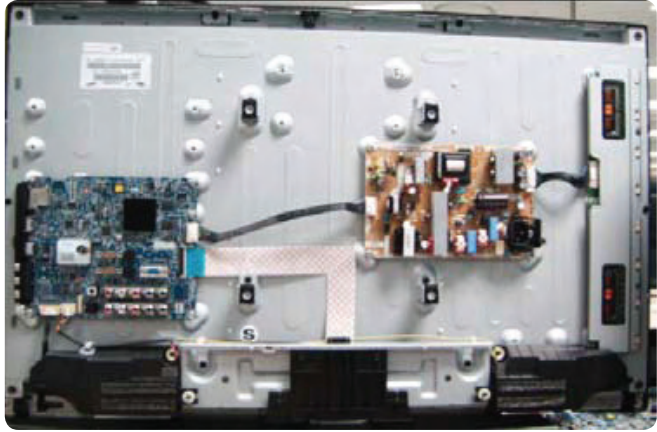
Symptom	<ul style="list-style-type: none"> - Audio is normal but no picture is displayed on the screen.
Major checkpoints	<ul style="list-style-type: none"> - Check the Video CVBS source - Check the Chelsea. - This may happen when the LVDS cable connecting the Main Board and the Panel is disconnected.
Diagnostics	 <pre> graph TD Q1[Power indicator LED is off. Lamp(Backlight) on, no video ?] -- No --> A1[Check a set in the 'Stand-by mode'] Q1 -- Yes --> Q2[Check the video source and check the connection of video cable?] Q2 -- No --> A2[Input the video source properly.] Q2 -- Yes --> Q3[Does the CVBS data appear at TP-COMP1_Y TP-SIDE_AV_CVBS ?] Q3 -- No --> A3[Check CN1101, CN1105_SAV. Change the Main Assy.] Q3 -- Yes --> Q4[Does the digital data appear at TP-E_TXCLK+, E_TXCLK-, O_TXCLK+, O_TXCLK- ?] Q4 -- No --> A4[Check IC3002 (X4). Change the Main Assy.] Q4 -- Yes --> Q5[Check the LVDS cable? Check the T-Con B'd? Replace the LCD panel?] Q5 -- No --> A5[Please, Contact Tech support.] </pre>
Caution	Make sure to disconnect the power before working on the IP board.

■ WAVEFORMS

④ CVBS OUT (Grey Bar)

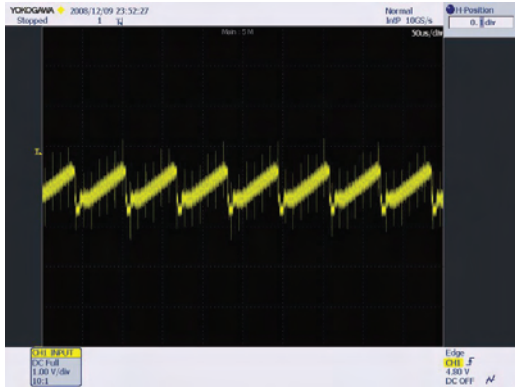

② LVDS output

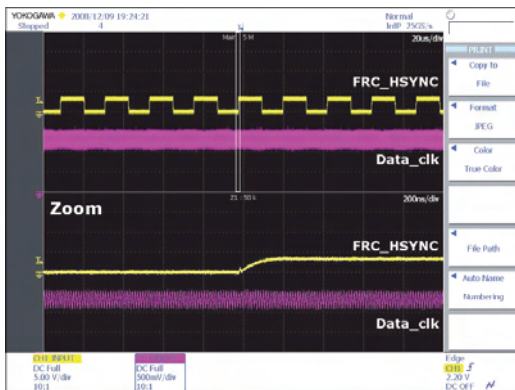

4-1-6. No Video_Component (X4)

Symptom	- Audio is normal but no picture is displayed on the screen.
Major checkpoints	<ul style="list-style-type: none"> - Check the Component source - Check the chelsea. - This may happen when the LVDS cable connecting the Main Board and the Panel is disconnected.

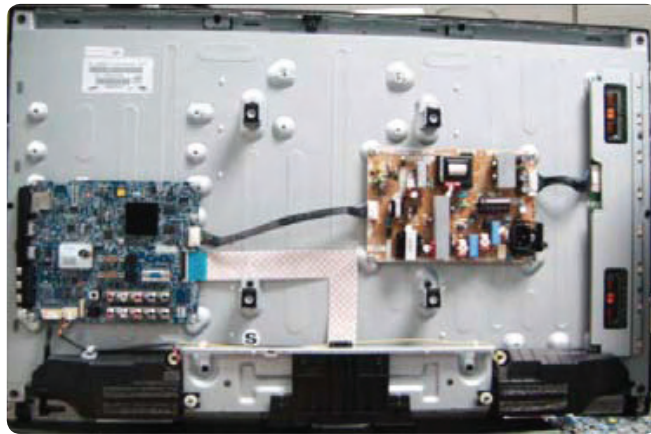

Diagnostics

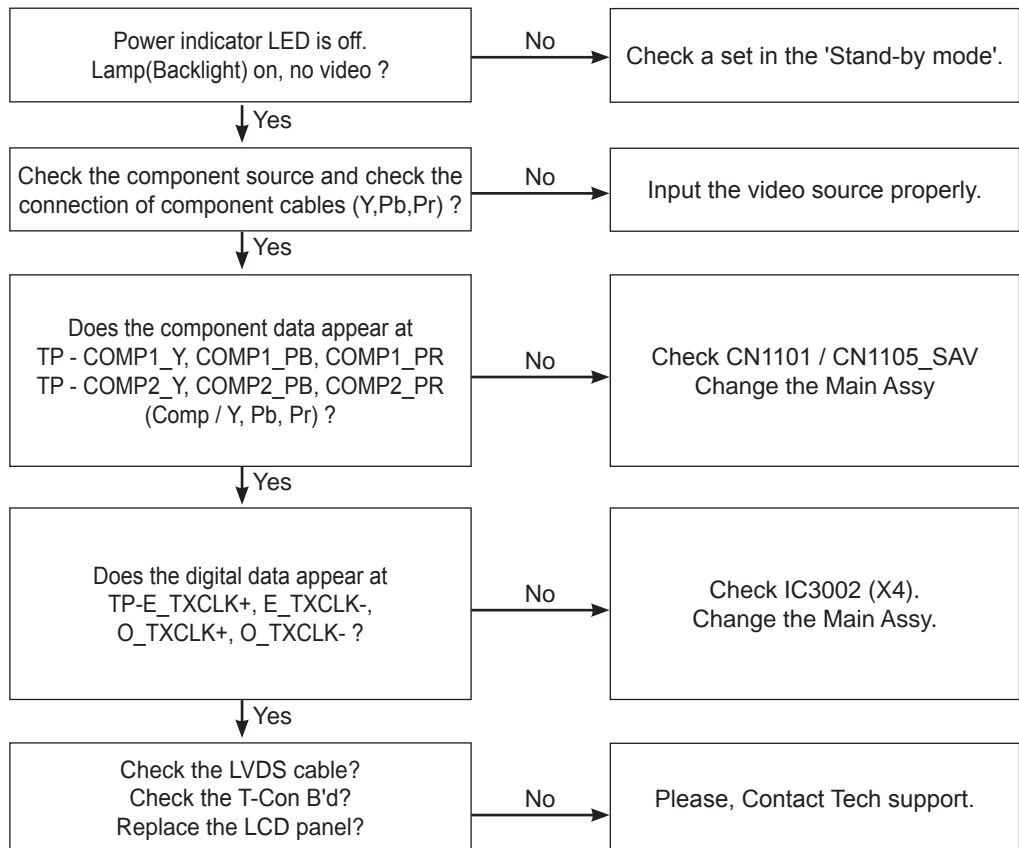

Caution	Make sure to disconnect the power before working on the IP board.
---------	---

■ WAVEFORMS

5 Compent_Y (Gray scale) / Pb / Pr (Color bar)



2 LVDS output

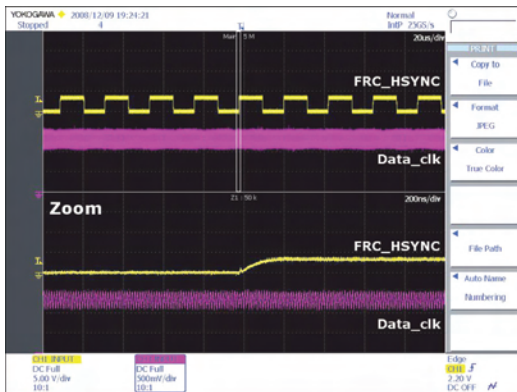

4-1-7. No Sound (X4)

Symptom	- Video is normal but there is no sound..
Major checkpoints	<ul style="list-style-type: none"> - When the speaker connectors are disconnected or damaged. - When the sound processing part of the Main Board is not functioning. - Speaker defect..

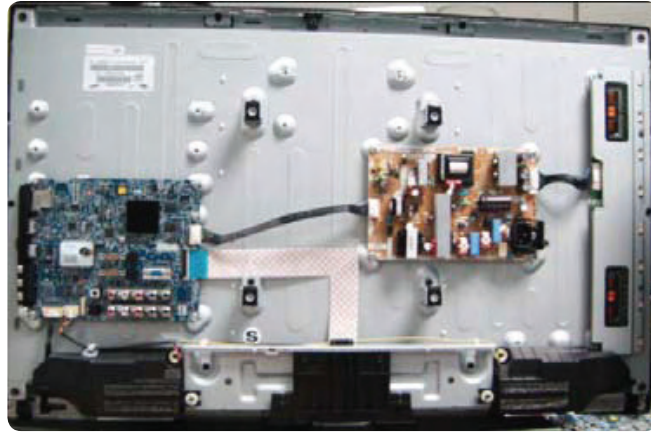

Diagnostics

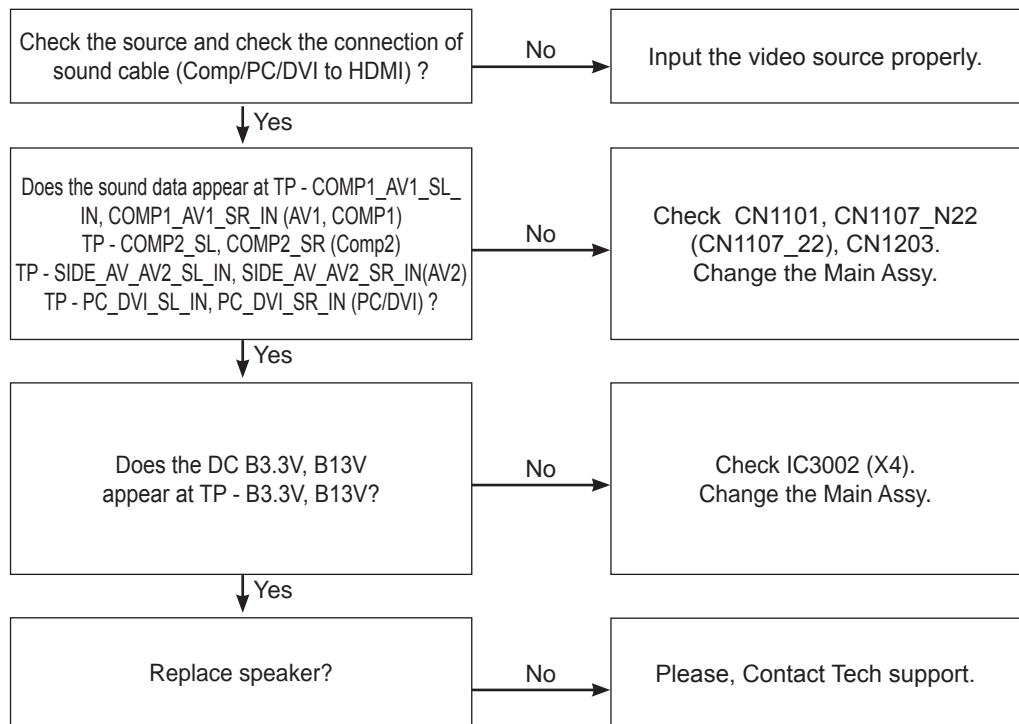

Caution	Make sure to disconnect the power before working on the IP board.
---------	---

■ WAVEFORMS

7 Speaker out

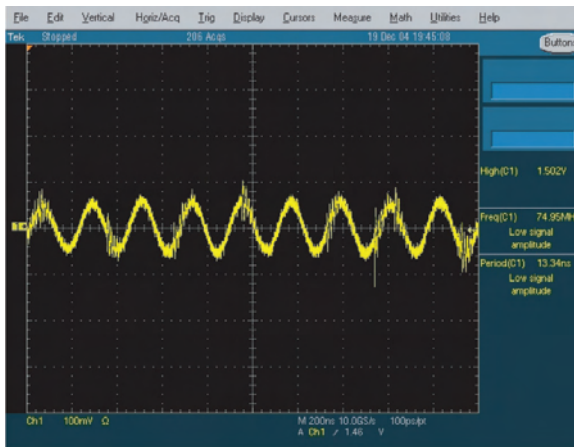

4-2. Alignments and Adjustments

4-2-1. General Alignment Instruction

1. Usually, a color LCD-TV needs only slight touch-up adjustment upon installation. Check the basic characteristics such as height, horizontal and vertical sync.
2. Use the specified test equipment or its equivalent.
3. Correct impedance matching is essential.
4. Avoid overload. Excessive signal from a sweep generator might overload the front-end of the TV. When inserting signal markers, do not allow the marker generator to distort test result.
5. Connect the TV only to an AC power source with voltage and frequency as specified on the backcover nameplate.
6. Do not attempt to connect or disconnect any wire while the TV is turned on. Make sure that the power cord is disconnected before replacing any parts.
7. To protect against shock hazard, use an isolation transformer.

4-3. Factory Mode Adjustments

4-3-1 Entering Factory Mode

To enter 'Service Mode' Press the remote -control keys in this sequence :
 - If you do not have Factory remote - control

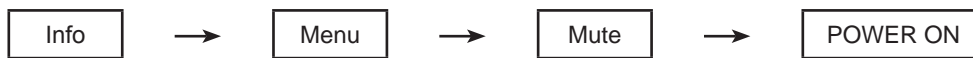

4-3-2 How to Access Service Mode

Using the Customer Remote

1. Turn the power off and set to stand-by mode
2. Press the remote buttons in this order to turn the set on.
3. The set turns on and enters service mode. This may take approximately 20 seconds.
4. Press the Power button to exit and store data in memory.
 - If you fail to enter service mode, repeat steps 1 and 2 above.
5. Initial SERVICE MODE DISPLAY State

SX1
Option
Control
SVC
ADC/WB
Advanced
T-TDT5DAAC-XXX T-TDT5DAAC-XXX EDID SUCCESS CALIB : AV X COM X PC X HDMI X Option : XXXX XXXX XXXX X
SDAL-XXX RFS : 0130 T-TDT5DAAC 20XX-XX-XX TYPE : XX MODEL : XXXXX MAC FAIL FACTORY DATA VER : XXX EERC VERSION : XXX DTP-AP-COMP-310-01 DTP-HIIG-0304 DTP-BP-0314 DATE OF PURCHASE : XX/XX/XX

X4
Option
Control
SVC
ADC/WB
Advanced
T-MSX5DAAC-XXX T-MSX5DAAC-XXX EDID SUCCESS CALIB : AV X COM X PC X HDMI X Option : XXXX XXXX XXXX X
SDAL-XXX RFS : P0154 T-MSX5DAAC 20XX-XX-XX TYPE : XX MODEL : XXXXX MAC FAIL FACTORY DATA VER : XXX EERC VERSION : XXX DTP-AP-COMP-310-01 DTP-HIIG-0304 DTP-BP-0314 DATE OF PURCHASE : XX/XX/XX

- * How to enter the hidden factory mode.
- a. into the factory mode
 - b. move the tap to Advanced
 - c. key input : 0 + 0 + 0 + 0
- ** hidden menu : Advanced

6. Buttons operations withn Service Mode

Menu	Full Menu Display/Move to Parent Menu
Direction Keys ▲/▼	Item Selection by Moving the Cursor
Direction Keys ◀/▶	Data Increase / Decrease for the Selected Item
Source	Cycles through the active input source that are connected to the unit

4-3-3 Factory Data (SX1)

■ Option

OPTION	Factory Name	Data	Range
	Factory Reset		
	Type		NONE/19O6TH0C/19A6TH0C/22I6TH0C/22A6TH0C/22D6TH0C/22P6TH0C/26A6AH0C/26D6AH0C/26L6AH0C/26P6AH0C/32A6AH0C/32D6AH0C/32L6AH0C/32P6AH0C/32A6AF0C/32L6AF0C/32A1AF0C/32L1AF0C/37L6AF0C/37L1AF0C/40A6AF0C/40D6AF0C/40L6AF0C/40A1AF0C/40L1AF0C/40A1UF0C/40D1UF0C/40L1UF0C/46A6AF0C/46D6AF0C/46L6AF0C/46A1AF0C/46L1AF0C/46A1UF0C/46D1UF0C/46L1UF0C/55A1UF0C/55L1UF0C/65L1UF0C/19R6TH0E/22D6TH0E/26D6AH0E/32D6AH0E/32D6UF0E/32A1UF0E/32D1UF0E/37L6UF0E/37D1UF0E/37L1UF0E/40D6UF0E/40A1UF0E/40D1UF0E/46D6UF0E/46L6UF0E/46A1UF0E/46D1UF0E/46L1UF0E/55A1UF0E/55D1UF0E/55L1UF0E/65L1UF0E/42HHcD3/50HcD450FARn4/50FARv458FARn1/58FARv163FARn1/
	Local Set	...	
	Model	LC550 LC540 LC530 LC450	LC350/LC450/LC450H/LC451LC452/LC457HLC459H/LC480/LC530/LC530H/LC539H/LC540/LC550/LC560/LC580/LC570/LC610/LC620/LC630/LC631/LC632/LC633/LC640/LC650/LC652/LC653/LC654/LC670/ UC400/UC400H/UC4010/UC5000/UC5100/UC6000/UC6200/UC6300/UC6400/UC6400H/UC6500/UC6510/UC6530/UC6540/UC6550/UC6600/UC6620/UC6630/UC6700/UC6720/UC6730/UC6740/UC6800/UC6830/UC6900/UC6900H/UC8000/ PC420/PC430/PC431/PC432/PC450/PC451/PC480/PC520/PC530/PC531/PC540/PC541/PC550/PC551/PC560/PC580/PC590/PC670/PC6100/PC6400/PC6500/PC7000/PC7700/PC8000
	TUNER	DRX3900J	
	DDR	0	
	Country	USA	
	Front Color		NONE/W-MILKY/T-M-Brn/T-W-Brn/T-W-Gray/W-D-Gray/W-M-Whit/W-Violet/T-C-Gray/T-R-BLK/S-BLK/S-RBLK/S-C-Gray/

■ Control

Control	Factory Name		
	EDID		
	Sub Option		
	PDP Option		
	Hotel Option		
	Shop Option		
	Asia Option		
	Sound		
	Config Option		
	SCC		
EDID	Factory Name	Data	Range
	EDID ON/OFF	Off	
	EDID WRITE ALL	...	
	EDID WRITE PC	...	
	EDID WRITE HDMI	...	
	EDID WRITE HDMI1	...	
	EDID WRITE HDMI2	...	
	EDID WRITE HDMI3	...	
	EDID WRITE HDMI4	...	
	EDID 1.2 PORT	...	
	EDID WRITE DVI	...	

Sub Option	Factory Name	Data	Range
	RF Mute Time	600ms	0ms~1000ms
	RS-232 Jack	UART	Debug/Login/UART
	Watchdog	OFF	ON/OFF
	WD Count	0	255
	Dimm Type	EXT	fixed
	Lvds Format	JEIDA	JEIDA/VESA/19INCH
	MediaPlay DB	On whth 5MB	fixed
	MediaPlay Movie	chapterinMedia	fixed
	MediaPlay DLNA	OFF	fixed
	MediaPlay PlayList	OFF	fixed
	OTN Server Type	operationg	operation/development
	OTN Test Server	OFF	OFF/ A/B/C/D/E Zone
	OTN Support	ON	ON/OFF
	OTN Reset		not modified
	OTN Duration	OFF	ON/OFF
	OTN Fail Test	OFF	ON/OFF
	T-CON USB Download	Failure	fixed
	View Log		not modified
	SST		not modified
	2nd mips	ON	ON/OFF
	2nd mips count	0	0~255
	Region	USA	fixed
	PC Auto Ident	Enable	Auto/Enable
Hotel Option	Factory Name	Data	Range
	Hotel Mode	OFF	
	SI Vender	...	
	Power On Channel	...	
	Channel Type	...	
	Power On Volume	...	
	Min Volume	...	
	Max Volume	...	
	Panel Button Lock	...	
	Power On Source	...	
Shop Option	Factory Name	Data	Range
	Shop Mode	OFF	ON/OFF
	Exhibition Mode	OFF	ON/OFF

4. Troubleshooting

Sound	Factory Name	Data	Range
	High Devi	OFF	ON/OFF
	Carrier_Mute	ON	ON/OFF
	Speaker Delay Normal	10	0~255
	Pilot Level High Thld	0x70h	0x00~0xff
	Pilot Level Low Thld	0x20h	0x00~0xff
	Speaker EQ	ON	ON/OFF
	SPDIF PCM Gain	-9dB	-10dB~0dB

■ SVC

SVC	Factory Name	Data	Range
	Test Pattern		fixed
	Panel Display Time	0Hr	
	Tuner Status		

Test Pattern	Factory Name	Data	Range
	Pattern Sel	OFF	OFF/ White/Grey/Black/Red/Green/Blue
	RFC PC Mode	OFF	ON/OFF
	Logic Pattern Sel	...	Not modified
	Logic Level Sel	...	Not modified

TUNER STATUS	Factory Name	Data	Range
	DVB		
	ISDB-T		

DVB	Factory Name	Data	Range
	SNR		Not modified
	BER		Not modified
	Singal Strength		Not modified
	Bandwidth		Not modified
	Frequency		Not modified
	LNA Status		Not modified
	FFT		Not modified
	Modulation		Not modified
	Code Rate		Not modified
	GI		Not modified
	Hier Modulation		Not modified
	Frequency Offset		Not modified
	Timing Offset		Not modified
	AGC		Not modified
	UCB		Not modified
	PLL Type		Not modified
	DEMOD Type		Not modified
	TPS LOCK		Not modified
	RS Lock		Not modified
	SSI		Not modified
	SQI		Not modified

ISDB-T	Factory Name	Data	Range
	FFT Size_1		Not modified
	Guard Interval_1		Not modified
	Freq. Offset_1		Not modified
	SNR_1		Not modified
	IF AGC_1		Not modified
	TMCC Lock_1		Not modified
	TS Packet_1		Not modified
	Master Lock_1		Not modified
	A_Modulation_1		Not modified
	A_Code Rate_1		Not modified
	A_Timer InterLeave_1		Not modified
	A_Segments Num_1		Not modified
	A_Ber_1		Not modified
	B_Modulation_!		Not modified
	B_Code Rate_1		Not modified
	B_Timer InterLeave_1		Not modified
	B_Segments Num_1		Not modified
	B_BER_1		Not modified
	C_Modulation_1		Not modified
	C_Code Rate_1		Not modified
	C_Timer InterLeave_1		Not modified
	C_Segments Num_1		Not modified
	C_BER_1		Not modified

■ Expert

Expert	Factory Name	Data	Range
	N / D ADJ	Off	Off / On / FIX
	SOURCE	...	Not modified

■ ADC/WB

ADC/WB	Factory Name
	ADC
	ADC Target
	ADC RESULT
	WB

ADC	Factory Name	Data	Range
	AV Calibration	Success	Success / Failure
	Comp Calibration	Success	Success / Failure
	PC Calibration	Success	Success / Failure
	HDMI Calibration	Success	Success / Failure

ADC Target	Factory Name	Data	Range
	1st_AV_Low	18	0 ~ 255
	1st_AV_High	220	0 ~ 255
	1st_AV_Delta	1	0 ~ 255
	1st_COMP_Low	16	0 ~ 255
	1st_COMP_High	235	0 ~ 255
	1st_COMP_Delta	1	0 ~ 255
	1st_PC_Low	2	0 ~ 255
	1st_PC_High	235	0 ~ 255
	1st_PC_Delta	1	0 ~ 255
	2nd_Low	1	0 ~ 255
	2nd_High	235	0 ~ 255
	2nd_Delta	1	0 ~ 255

ADC RESULT	Factory Name	Data	Range
	1st_AV_Gain	127	0 ~ 255
	1st_AV_Offset	139	0 ~ 255
	1st_Comp_Gain	68	0 ~ 255
	1st_Comp_Gain_Cb	68	0 ~ 255
	1st_Comp_Gain_Cr	68	0 ~ 255
	1st_Comp_Offset	127	0 ~ 255
	1st_Comp_Offset_Cb	127	0 ~ 255
	1st_Comp_Offset_Cr	127	0 ~ 255
	1st_PC_R_Gain	96	0 ~ 255
	1st_PC_G_Gain	95	0 ~ 255
	1st_PC_B_Gain	94	0 ~ 255
	1st_PC_R_Offset	127	0 ~ 255
	1st_PC_G_Offset	127	0 ~ 255
	1st_PC_B_Offset	127	0 ~ 255
	2nd_R_Offset	110	0 ~ 255
	2nd_G_Offset	110	0 ~ 255
	2nd_B_Offset	110	0 ~ 255
	2nd_R_Gain	165	0 ~ 255
	2nd_G_Gain	165	0 ~ 255
	2nd_B_Gain	165	0 ~ 255

WB	Factory Name	Data	Range
	Sub Brightness	128	0 ~ 255
	R_Offset	128	0 ~ 255
	G_Offset	128	0 ~ 255
	B_Offset	128	0 ~ 255
	Sub Contrast	128	0 ~ 255
	R_Gain	128	0 ~ 255
	G_Gain	128	0 ~ 255
	B_Gain	128	0 ~ 255
	Movie R Offset	122	0 ~ 255
	Movie B Offset	145	0 ~ 255
	Movie R Gain	156	0 ~ 255
	Movie B Gain	39	0 ~ 255

4-3-5. Factory Data (X4)

■ Option

OPTION	Factory Name	Data	Range	Remark
	Factory Reset			
	Type	26D6AH0C 32D6AH0C 32L6AF0C 37L6AF0C 40D6AF0C 46L6AF0C	NONE/19O6TH0C/19A6TH0C/22I6TH0C/22A6TH0C/22D6TH0C/2 2P6TH0C/26A6AH0C/26D6AH0C/26L6AH0C/26P6AH0C/32A6AH 0C/32D6AH0C/32L6AH0C/32P6AH0C/32A6AF0C/32L6AF0C/32A 1AF0C/32L1AF0C/37L6AF0C/37L1AF0C/40A6AF0C/40D6AF0C/4 0L6AF0C/40A1AF0C/40L1AF0C/40A1UF0C/40D1UF0C/40L1UF0 C/46A6AF0C/46D6AF0C/46L6AF0C/46A1AF0C/46L1AF0C/46A1 UF0C/46D1UF0C/46L1UF0C/55A1UF0C/55L1UF0C/65L1UF0C/1 9O6TH0E/22D6TH0E/26D6AH0E/32D6AH0E/32D6UF0E/32A1UF 0E/32D1UF0E/37L6UF0E/37D1UF0E/37L1UF0E/40D6UF0E/40A1 UF0E/40D1UF0E/46D6UF0E/46L6UF0E/46A1UF0E/46D1UF0E/4 6L1UF0E/55A1UF0E/55D1UF0E/55L1UF0E/65L1UF0E/42HHcD3/ 50HHcD450FArN4/50FArV458FArN1/58FArV163FArN1/	
	Local Set	...		
	Model	LC450 LC530 LN540 LC550	LC350/LC450/LC450H/LC451/LC452/LC457HLC459H/LC480/ LC530/LC530H/LC539H/LC540/LC550/LC560/LC580/LC570/ LC610/LC620/LC630/LC631/LC632/LC633/LC640/LC650/LC652/ LC653/LC654/LC670/ UC4000/UC4000H/UC4010/UC5000/UC5100/UC6000/UC6200/ UC6300/UC6400/UC6400H/UC6500/UC6510/UC6530/UC6540/ UC6550/UC6600/UC6620/UC6630/UC6700/UC6720/UC6730/ UC6740/UC6800/UC6830/UC6900/UC6900H/UC8000/ PC420/PC430/PC431/PC432/PC450/PC451/PC480/PC520/ PC530/PC531/PC540/PC541/PC550/PC551/PC560/PC580/ PC590/PC670/PC6100/PC6400/PC6500/PC7000/PC7700/PC8000	
	TUNER	SEMCO081A	SEMPA081/SEMCO081A/ALPSK02A/Error	
	DDR	0	0~2	
	Light Effect	OFF	ON/OFF	INFO+FACTORY
	Ch Table	...	NONE/SUWON/SAMEX	
	Country	USA	USA/PANAMA	
	Front Color	T-R-BLK S-R-BLK	NONE/W-MILKY/T-M-Brn/T-W-Brn/T-W-Gray/W-D-Gray/W-M-Whit/ W-Violet/T-C-Gray/T-R-BLK/S-BLK/S-R-BLK/S-C-Gray/	

■ Control

Control	Factory Name	Range	Remark
	EDID	SUB MENU	
	Sub Option	SUB MENU	
	PDP Option		
	Hotel Option	SUB MENU	
	Shop Option	SUB MENU	
	Asia Option	SUB MENU	INFO+FACTORY
	Sound	SUB MENU	
	Config Option	SUB MENU	INFO+FACTORY
	SCC	SUB MENU	INFO+FACTORY

EDID	Factory Name	Data	Range	Remark
	EDID ON/OFF	Off	ON/OFF	
	EDID WRITE ALL	Success	Success/failure	
	EDID WRITE PC	Success	Success/failure	
	EDID WRITE HDMI	...	Success/failure	
	EDID WRITE HDMI1	Success	Success/failure	
	EDID WRITE HDMI2	Success	Success/failure	
	EDID WRITE HDMI3	Success	Success/failure	
	EDID WRITE HDMI4	Success	Success/failure	
	EDID 1.2 PORT	NONE	NONE/Not Support/HDMI2/HDMI3/HDMI4	
	EDID WRITE DVI	...	fixed	

Sub Option	Factory Name	Data	Range	Remark
	RF Mute Time	600ms	0ms~1000ms	
	RS-232 Jack	UART	Debug/Login/UART	
	Watchdog	OFF	ON/OFF	
	WD Count	0	0~255	
	Dimm Type	EXT	fixed	
	Lvds Format	JEIDA	JEIDA/VESA/19INCH	
	Language_Arbic	...	fixed	INFO+FACTORY
	TOOLS Support	32	0~255	INFO+FACTORY
	LNA Support	0	0~255	INFO+FACTORY
	MediaPlay DB	On whth 5MB	fixed	
	MediaPlay Movie	chapterinMedia	fixed	
	MediaPlay DLNA	OFF	fixed	
	MediaPlay PlayList	OFF	fixed	
	NETWORK Support	Wireless	Not Support/Cable/Wireless	INFO+FACTORY
	Info Link Server Type	operationg	operationgdevelopment/developing	INFO+FACTORY
	Info Link Country	USA	None/USA	INFO+FACTORY
	TTX List	...	fixed	INFO+FACTORY
	TTX Group	...	fixed	INFO+FACTORY
	24Px4 Support	OFF	ON/OFF	INFO+FACTORY
	Power Indicator Support	OFF	ON/OFF	INFO+FACTORY
	BD Wise Support	ON	ON/OFF	INFO+FACTORY
	Data Service Support	OFF	ON/OFF	INFO+FACTORY

4. Troubleshooting

Alternate Del	OFF	ON/OFF	INFO+FACTORY
OTN Server Type	operating	operation/development	
OTN Test Server	OFF	OFF/ A/B/C/D/E Zone	
OTN Support	OFF	ON/OFF	
OTN Reset			
OTN Duration	OFF	ON/OFF	
OTN Fail Test	OFF	ON/OFF	
IIC Bus Stop	OFF	ON/OFF	INFO+FACTORY
Visual Test	Disable	fixed	INFO+FACTORY
T-CON USB Download	Failure	fixed	
Emergency Log Copy			INFO+FACTORY
Checksum	0x0000		INFO+FACTORY
View Log		SUB MENU	
Factory Name	Data	Range	Remark
Select Log Type	IR Key	NVRAM / DIAGNOSIS / IR KEY	
Log View			
Delete Log			
ColorSpace Support	HueSate Type	RGB Type / HueSate Type	INFO+FACTORY
Gemstar On/Off	OFF	ON/OFF	INFO+FACTORY
WSS Support	OFF	ON/OFF	INFO+FACTORY
PVR Support	OFF	ON/OFF	INFO+FACTORY
CI Support	OFF	ON/OFF	INFO+FACTORY
Eeprom Reset		SUB MENU	INFO+FACTORY
Factory Name	Data	Range	Remark
Select Log Type	IR Key	NVRAM / DIAGNOSIS / IR KEY	
Log View			
Delete Log			
Spread Spectrum		SUB MENU	INFO+FACTORY
Factory Name	Data	Range	Remark
LVDS Spread	ON	ON/OFF	INFO+FACTORY
Period	40K	30K/40K/50K/60K	INFO+FACTORY
Amplitude	1.5	0.0/0.5/1.0/1.5/2.0/2.5/3.0	INFO+FACTORY
DDR Spread	1.00%	0.1~2.0%	INFO+FACTORY
DDR Margin		SUB MENU	INFO+FACTORY
Factory Name	Data	Range	Remark
A CTRL_OFFSET_0_3	0X0	fixed	INFO+FACTORY
A CTRL_OFFSET_D	0X0	fixed	INFO+FACTORY
B CTRL_OFFSET_0_3	0X0	fixed	INFO+FACTORY
B CTRL_OFFSET_D	0X0	fixed	INFO+FACTORY
H.264 Margin	200	0~2000	
MPEG Margin	50	0~2001	

Tuner Margin	50	0~2002	
SST		SUB MENU	
Factory Name	Data	Range	Remark
Y0 Ref	166	0~255	
Y1 Ref	148	0~255	
Y2 Ref	119	0~255	
Y3 Ref	101	0~255	
Y4 Ref	76	0~255	
Y5 Ref	60	0~255	
Y6 Ref	31	0~255	
Y7 Ref	0	0~255	
Cb0 Ref	128	0~255	
Cb1 Ref	64	0~255	
Cb2 Ref	148	0~255	
Cb3 Ref	85	0~255	
Cb4 Ref	171	0~255	
Cb5 Ref	108	0~255	
Cb6 Ref	194	0~255	
Cb7 Ref	0	0~255	
Cr0 Ref	128	0~255	
Cr1 Ref	137	0~255	
Cr2 Ref	64	0~255	
Cr3 Ref	74	0~255	
Cr4 Ref	181	0~255	
Cr5 Ref	192	0~255	
Cr6 Ref	118	0~255	
Cr7 Ref	0	0~255	
SST_Th		SUB MENU	
Factory Name	Data	Range	Remark
Y0 TH	20	0~255	
Y1 TH	20	0~255	
Y2 TH	20	0~255	
Y3 TH	20	0~255	
Y4 TH	20	0~255	
Y5 TH	20	0~255	
Y6 TH	20	0~255	
Y7 TH	20	0~255	
Cb0 TH	20	0~255	
Cb1 TH	20	0~255	
Cb2 TH	20	0~255	
Cb3 TH	20	0~255	
Cb4 TH	20	0~255	
Cb5 TH	20	0~255	
Cb6 TH	20	0~255	
Cb7 TH	20	0~255	

4. Troubleshooting

	Cr0 TH	20	0~255	
	Cr1 TH	20	0~255	
	Cr2 TH	20	0~255	
	Cr3 TH	20	0~255	
	Cr4 TH	20	0~255	
	Cr5 TH	20	0~255	
	Cr6 TH	20	0~255	
	Cr7 TH	20	0~255	
	2nd mips	ON	ON/OFF	
	2nd mips count	0	0~255	
	Region	KOR	fixed	
	PnP Language	...	fixed	INFO+FACTORY
	PC Auto Ident	Enable	Auto/Enable	
Hotel Option	Factory Name	Data	Range	Remark
	Hotel Mode	OFF	ON/OFF	
	SI Vender	Samsung	Samsung/2M/Locatel/VDA/VDA-S/Acentic/Premiere/Sustinere/Quadriga/ETV/Ibahn/Magilink/Otrum/PeninsulaSiemens/OCC/MTI/MstreamsDAWNXTV/Enseo/Cardinal/Guestek/OFF/Movielink/Swisscom	
	Power On Channel	3	1~135	
	Channel Type	ATV	ATV/DTV/CATV/CDTV	
	Power On Volume	10	0~100	
	Min Volume	0	0~100	
	Max Volume	100	0~100	
	Panel Button Lock	Unlock	Unlock/Lock/OnlyPower	
	Power On Source	TV	TV/AV/Comp/PC/HDMI1/HDMI2/HDMI3/HDMI4	
Shop Option	Factory Name	Data	Range	Remark
	Shop Mode	OFF	ON/OFF	
	Exhibition Mode	OFF	ON/OFF	
Asia Option	Factory Name	Data	Range	Remark
	TTX	OFF	ON/OFF	INFO+FACTORY
	China HD	OFF	ON/OFF	INFO+FACTORY
	NT Conversion	OFF	ON/OFF	INFO+FACTORY
	Sepco 120Hz	OFF	ON/OFF	INFO+FACTORY
	Unbalance	OFF	ON/OFF	INFO+FACTORY
	FMTransmitter Support	OFF	ON/OFF	INFO+FACTORY
	FMTransmitter Carrier	OFF	ON/OFF	INFO+FACTORY
	AF Level adjust	3	0~7	INFO+FACTORY
	TX Power Level	0	0~3	INFO+FACTORY
Mono Last Memory	OFF	ON/OFF	INFO+FACTORY	

Sound	Factory Name	Data	Range	Remark
	High Devi		OFF	ON/OFF
Carrier_Mute		ON	ON/OFF	
Volume Curve	Type2		Type1/Type2/error	INFO+FACTORY
Speaker Delay Normal		10	0~255	
Pilot Level High Thld		0x08h	0x00~0xff	
Pilot Level Low Thld		0x05h	0x00~0xff	
FM Prescale		17	0~255	INFO+FACTORY
AM Prescale		10	0~255	INFO+FACTORY
NICAM Prescale		33	0~255	INFO+FACTORY
Amp Volume		0x10h	0x00~0xff	INFO+FACTORY
Amp Scale		0x78h	0x00~0xff	INFO+FACTORY
Amp Check Sum		0x0000a820	fixed	INFO+FACTORY
Woofers Type		4	1~7	INFO+FACTORY
Woofers Scale		0x7Fh	0x00~0xff	INFO+FACTORY
Woofers Check Sum				INFO+FACTORY
Speaker EQ		ON	ON/OFF	
PEQ Test		0	0~7	INFO+FACTORY
Amp Model		NTP7300	SAT369B/TAS5715/NPT7300	INFO+FACTORY
Speaker cut-off Freq		4	0~16	INFO+FACTORY
SPDIF PCM Gain		-9dB	-10dB~0dB	INFO+FACTORY
BTSC Mono Prescale		0	-10~10	INFO+FACTORY
BTSC stereo Prescale		0	-10~10	INFO+FACTORY
SAO Prescale		0	-10~10	INFO+FACTORY
A2 Ident High Thld		0	-10~10	INFO+FACTORY
A2 Ident Low Thld		0	-10~10	INFO+FACTORY
Carrier2 Amp High Thld		0	-10~10	INFO+FACTORY
Carrier2 Amp Low Thld		0	-10~10	INFO+FACTORY
Carrier2 SNR High THR		0	-10~10	INFO+FACTORY
Carrier2 SNR Low THR		0	-10~10	INFO+FACTORY

Config Option	Factory Name	Data	Range	Remark
	Num of ATV		1	1~2
Num of DTV		1	0~2	INFO+FACTORY
Num of AV		2	0~3	INFO+FACTORY
Num of SVIDEO		0	1~3	INFO+FACTORY
Num of Comp		2	1~3	INFO+FACTORY
Num of HDMI		4	0~4	INFO+FACTORY
Num of PC		1	0~1	INFO+FACTORY
Num of SCART		0	0~2	INFO+FACTORY
Num of DVI		0	0~1	INFO+FACTORY
Num of OPTICAL Link		0	fixed	INFO+FACTORY
Num of MEDIA		1	0~1	INFO+FACTORY
Num of PANEL KEY		6	0~8	INFO+FACTORY
Num of USB Port		2	0~2	INFO+FACTORY
Num of HeadPhone		0	0~1	INFO+FACTORY
MFT Offset		62.5	50/62.5	INFO+FACTORY

4. Troubleshooting

Select LCD/PDP	LCD	LCD/PDP	INFO+FACTORY
HDMI/DVI SEL	1	1~4	INFO+FACTORY
Indicator Led	OFF	ON/OFF	INFO+FACTORY
Wall Mount	OFF	ON/OFF	INFO+FACTORY
HV Flip	ON	ON/OFF	INFO+FACTORY
Num of Display	2	1~2	INFO+FACTORY
DVI/HDMI SOUND	Auto	Auto/DVI	INFO+FACTORY
HDMI HOT PLUG	Disable	Enable/Disable	INFO+FACTORY
HOTPLUG SWITCHING	Boot	Disable/Boot/Source	INFO+FACTORY
HOTPLUG DURATION	1200ms	0~2000ms	INFO+FACTORY
CLK TERM DURATION	1200ms	0~2000ms	INFO+FACTORY
HDMI FLT CNT SIG	200ms	0~1000ms	INFO+FACTORY
HDMI FLT CNT LOS	600ms	0~1000ms	INFO+FACTORY
UNSTABLE BAN CNT	3500ms	0~100000ms	INFO+FACTORY
HDMI Err Cnt	5	0~10	INFO+FACTORY
HDMI ROBIN	ON	ON/OFF	INFO+FACTORY
HDMI Callback	OFF	ON/OFF	INFO+FACTORY
HDMI CTS Thld	8	0~15	INFO+FACTORY
HDMI CTS Cnt1	1	0~15	INFO+FACTORY
TMDS_EQ2_Boost	1	0~7	INFO+FACTORY
TMDS_EQ2_Gain	0	0~3	INFO+FACTORY
TMDS_PLL_Loop	3	0~3	INFO+FACTORY
TMDS_CPREG_BLEED	1	0~1	INFO+FACTORY
HDMI EQ	AUTO	AUTO/Low/Middle/High/Strong	INFO+FACTORY
HDMI Write Type	Combine	Combine/Separate	INFO+FACTORY
HDMI Switch	SIL9287	NONE/SIL9287/TMDS461	INFO+FACTORY
DVI SET TIME	300ms	0~1000ms	INFO+FACTORY
Type Of PANEL KEY	Horizontal	Horizontal/Vertical/PDPVertical/Nne	INFO+FACTORY
EcoSensor Support	ON	ON/OFF	INFO+FACTORY
LEDMotionPlus Support	OFF	ON/OFF	INFO+FACTORY
Natural Mode Support	ON	ON/OFF	INFO+FACTORY
All Share Support	ON	ON/OFF	INFO+FACTORY
Relax Mode Support	OFF	ON/OFF	INFO+FACTORY
DVI-I Support	...	fixed	INFO+FACTORY
Melfas Function Support	...	fixed	INFO+FACTORY
Light Level Support	...	fixed	INFO+FACTORY

SCC

Factory Name	Data	Range	Remark
SCC Mode	Dynamic	Dynamic/Movie	INFO+FACTORY
SCC ON/OFF	OFF	ON/OFF	INFO+FACTORY
SCC Input Data		SUB MENU	INFO+FACTORY
Factory Name	Data	Range	Remark
Hx	272	0~512	INFO+FACTORY
Hy	273	0~512	INFO+FACTORY
Lx	274	0~512	INFO+FACTORY
Ly	275	0~512	INFO+FACTORY

sSCC Const		SUB MENU	INFO+FACTORY
Factory Name	Data	Range	Remark
sSCC Hx	550	0~1024	INFO+FACTORY
sSCC Hy	566	0~1024	INFO+FACTORY
sSCC Lx	598	0~1024	INFO+FACTORY
sSCC Ly	550	0~1024	INFO+FACTORY
pSCC Const		SUB MENU	INFO+FACTORY
Factory Name	Data	Range	Remark
Hx	272	0~512	INFO+FACTORY
Hy	273	0~512	INFO+FACTORY
Lx	274	0~512	INFO+FACTORY
Ly	275	0~512	INFO+FACTORY
SCC Source Data	PBA	PBA/PANEL	INFO+FACTORY
SWAP	PBA	PBA/PANEL	INFO+FACTORY
SCC Source Data	PBA	PBA/PANEL	INFO+FACTORY
SWAP	PBA	PBA/PANEL	INFO+FACTORY

■ SVC

Shop Option	Factory Name	Data	Range	Remark
	Test Pattern		SUB MENU	
	Factory Name	Data	Range	Remark
	Pattern Sel	OFF	OFF/ White/Grey/Black/Red/Green/Blue	
	Logic Pattern Sel	...	fixed	
	Logic Level Sel	...	fixed	
	Panel Auto Setting	Success		INFO+FACTORY
	Panel Display Time	8Hr	fixed	
	Logic Usb D/L	Off	fixed	INFO+FACTORY
	Tuner Status			

TUNER STATUS	Factory Name	Data	Range	Remark
	DVB		SUB MENU	
	Factory Name	Data	Range	Remark
	SNR		fixed	
	BER		fixed	
	Singal Strength		fixed	
	Bandwidth		fixed	
	Frequency		fixed	
	LNA Status		fixed	
	FFT		fixed	
	Modulation		fixed	
	Code Rate		fixed	
	GI		fixed	

4. Troubleshooting

Hier Modulation		fixed	
Frequency Offset		fixed	
Timing Offset		fixed	
AGC		fixed	
UCB		fixed	
PLL Type		fixed	
DEMODO Type		fixed	
TPS LOCK		fixed	
RS Lock		fixed	
SSI		fixed	
SQI		fixed	
ISDB-T		SUB MENU	
Factory Name	Data	Range	Remark
FFT Size_1		fixed	
Guard Interval_1		fixed	
Freq. Offset_1		fixed	
SNR_1		fixed	
IF AGC_1		fixed	
TMCC Lock_1		fixed	
TS Packet_1		fixed	
Master Lock_1		fixed	
A_Modulation_1		fixed	
A_Code Rate_1		fixed	
A_Timer InterLeave_1		fixed	
A_Segments Num_1		fixed	
A_Ber_1		fixed	
B_Modulation_1		fixed	
B_Code Rate_1		fixed	
B_Timer InterLeave_1		fixed	
B_Segments Num_1		fixed	
B_BER_1		fixed	
C_Modulation_1		fixed	
C_Code Rate_1		fixed	
C_Timer InterLeave_1		fixed	
C_Segments Num_1		fixed	
C_BER_1		fixed	

■ Expert

ADC/WB	Factory Name	Data	Range	Remark
	ADC		SUB MENU	
	Factory Name	Data	Range	Remark
	AV Calibration	Success	Success / Failure	
	Comp Calibration	Success	Success / Failure	
	PC Calibration	Success	Success / Failure	
	HDMI Calibration	Success	Success / Failure	
	ADC Target		SUB MENU	
	Factory Name	Data	Range	Remark
	1st_AV_Low	64	0 ~ 1020	
	1st_AV_High	880	0 ~ 1020	
	1st_AV_Delta	2	0 ~ 7	
	1st_COMP_Y_Low	64	0 ~ 1020	
	1st_COMP_Cb_Low	...		
	1st_COMP_Cr_Low	...		
	1st_COMP_Y_High	940	0 ~ 1020	
	1st_COMP_Cb_High	...		
	1st_COMP_Cr_High	...		
	1st_COMP_Delta	2	0~7	
	1st_PC_R_Low	16	0 ~ 1020	
	1st_PC_G_Low	...		
	1st_PC_B_Low	...		
	1st_PC_R_High	1004	0 ~ 1020	
	1st_PC_G_Low	...		
	1st_PC_B_Low	...		
	1st_PC_Delta	2	0~7	
	2nd_AV_R_Low	4	fixed	
	2nd_AV_G_Low	4	fixed	
	2nd_AV_B_Low	4	fixed	
	2nd_AV_R_High	940	fixed	
	2nd_AV_G_High	940	fixed	
	2nd_AV_B_High	940	fixed	
	2nd_AV_Delta	2	0~7	
	2nd_COMP_R_Low	4	fixed	
	2nd_COMP_G_Low	4	fixed	
	2nd_COMP_B_Low	4	fixed	
	2nd_COMP_R_High	940	fixed	
	2nd_COMP_G_High	940	fixed	
	2nd_COMP_B_High	940	fixed	
	2nd_COMP_Delta	2	0~7	
	2nd_PC_R_Low	4	fixed	
	2nd_PC_G_Low	4	fixed	
	2nd_PC_B_Low	4	fixed	
	2nd_PC_R_High	940	fixed	

4. Troubleshooting

2nd_PC_G_High	940	fixed	
2nd_PC_B_High	940	fixed	
2nd_PC_Delta	2	0~7	
2nd_HDMI_R_Low	4	fixed	
2nd_HDMI_G_Low	4	fixed	
2nd_HDMI_B_Low	4	fixed	
2nd_HDMI_R_High	940	fixed	
2nd_HDMI_G_High	940	fixed	
2nd_HDMI_B_High	940	fixed	
2nd_HDMI_Delta	2	0~7	

ADC RESULT

SUB MENU

Factory Name	Data	Range	Remark
1st_Y_GH	0	fixed	
1st_Y_GL	0	fixed	
1st_Cb_BH	0	fixed	
1st_Cb_BL	0	fixed	
1st_Cr_RH	0	fixed	
1st_Cr_RL	0	fixed	
2nd_R_L	134	0 ~ 255	
2nd_G_L	134	0 ~ 255	
2nd_B_L	134	0 ~ 255	
2nd_R_H	49	0 ~ 255	
2nd_G_H	49	0 ~ 255	
2nd_B_H	49	0 ~ 255	

WB

SUB MENU

Factory Name	Data	Range	Remark
Sub Brightness	128	0 ~ 1023	
R_Offset	512	0 ~ 1023	
G_Offset	512	0 ~ 1023	
B_Offset	512	0 ~ 1023	
Sub Contrast	128	0 ~ 1023	
R_Gain	512	0 ~ 1023	
G_Gain	512	0 ~ 1023	
B_Gain	512	0 ~ 1023	
Movie R Offset	...	fixed	
Movie B Offset	...	fixed	
Movie R Gain	...	fixed	
Movie B Gain	...	fixed	

4-4. White Balance - Calibration

4-4-1 White Balance -Calibration

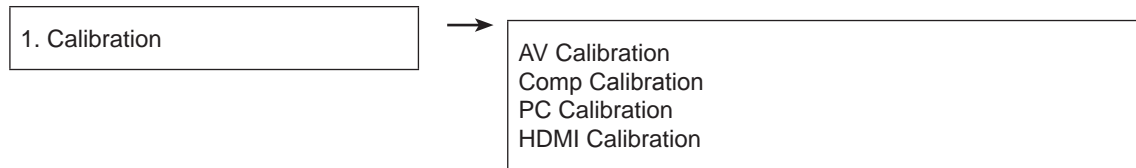

4-4-2 White Balance - Adjustment

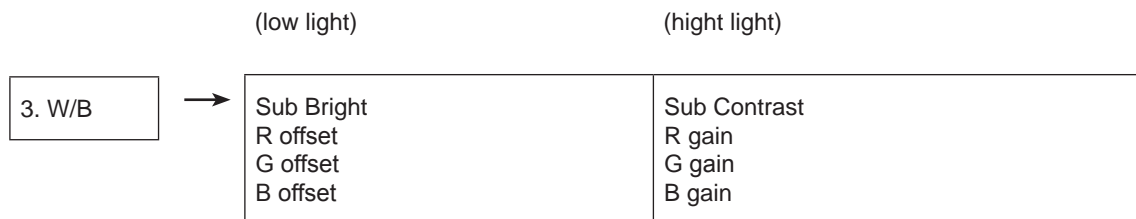

(W/B adjustment Condition refer next page)

4-5. White Ratio (Balance) Adjustment

1. You can adjust the white ratio in factory mode (1:Calibration, 3:White-Balance).
2. Since the adjustment value and the data value vary depending on the input source, you have to adjust these in CVBS, Component 1 and HDMI 1 modes.
3. The optimal values for each mode are configured by default. (Refer to Table 1, 2)
It varies with Panel's size and Specification.

- Equipment : CS-210
- Pattern: MIK K-7256 #92 "Flat W/B Pattern" as standard
- Use other equipment only after comparing the result with that of the Master equipment.
- Set Aging time : 60min ↑

- Calibration and Manual setting for WB adjustment.

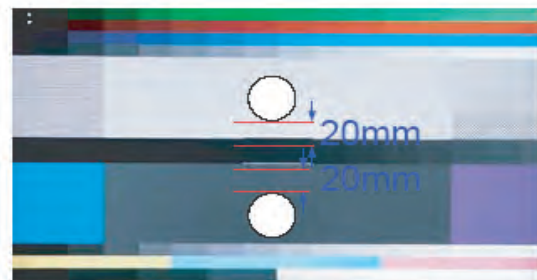

- HDMI : Calibration at #24 Chessboard Pattern → Manual adjustment #92 pattern (720p)
- COMP: Calibration at #24 Chessboard Pattern → Manual adjustment at #92 pattern (720p)
- CVBS: Calibration at #24 Chessboard Pattern → Manual adjustment at #92 pattern (NTSC)

- If finishing in HDMI mode, adjustment coordinate is almost same in AV/COMP mode.
- White Balance Manual Adjustment

4-6. Servicing Information

4-6-1 USB Download Method

Software Upgrade upgrades can be performed via broadcasting signal or by downloading the new firmware from samsung.com to a USB memory device.

Current Version is the software already installed in the TV.

Note Software is represented as 'Year/Month/Day_Version'.
Installing the latest version is recommended.

- ▶ **By USB:** Insert a USB drive containing the firmware upgrade file downloaded from samsung.com into the TV. Please be careful not to disconnect the power or remove the USB drive until upgrades is complete. The TV will turn off and on automatically after completing the firmware upgrade. When software is upgraded, video and audio settings you have made will return to their default settings. We recommend you to write down your settings so that you can easily reset them after the upgrade.
- ▶ **Alternative Software (Backup):** If there is an issue with the new firmware and it is affecting operation, you can change the software to the previous version.
Note If software was changed, existing software is displayed.

6. Wiring Diagram

6-1. Wiring Diagram

■ C450 : 22"

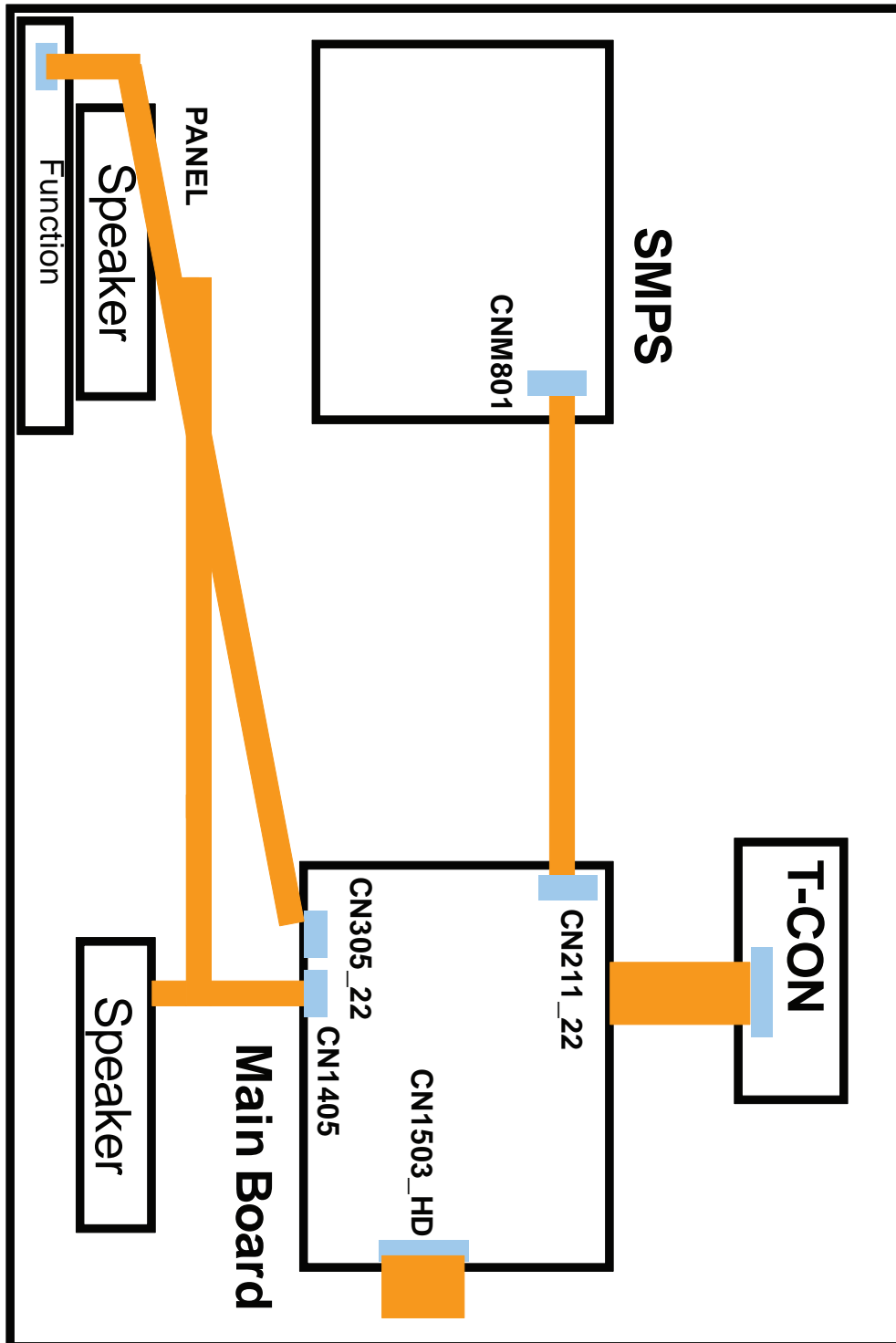

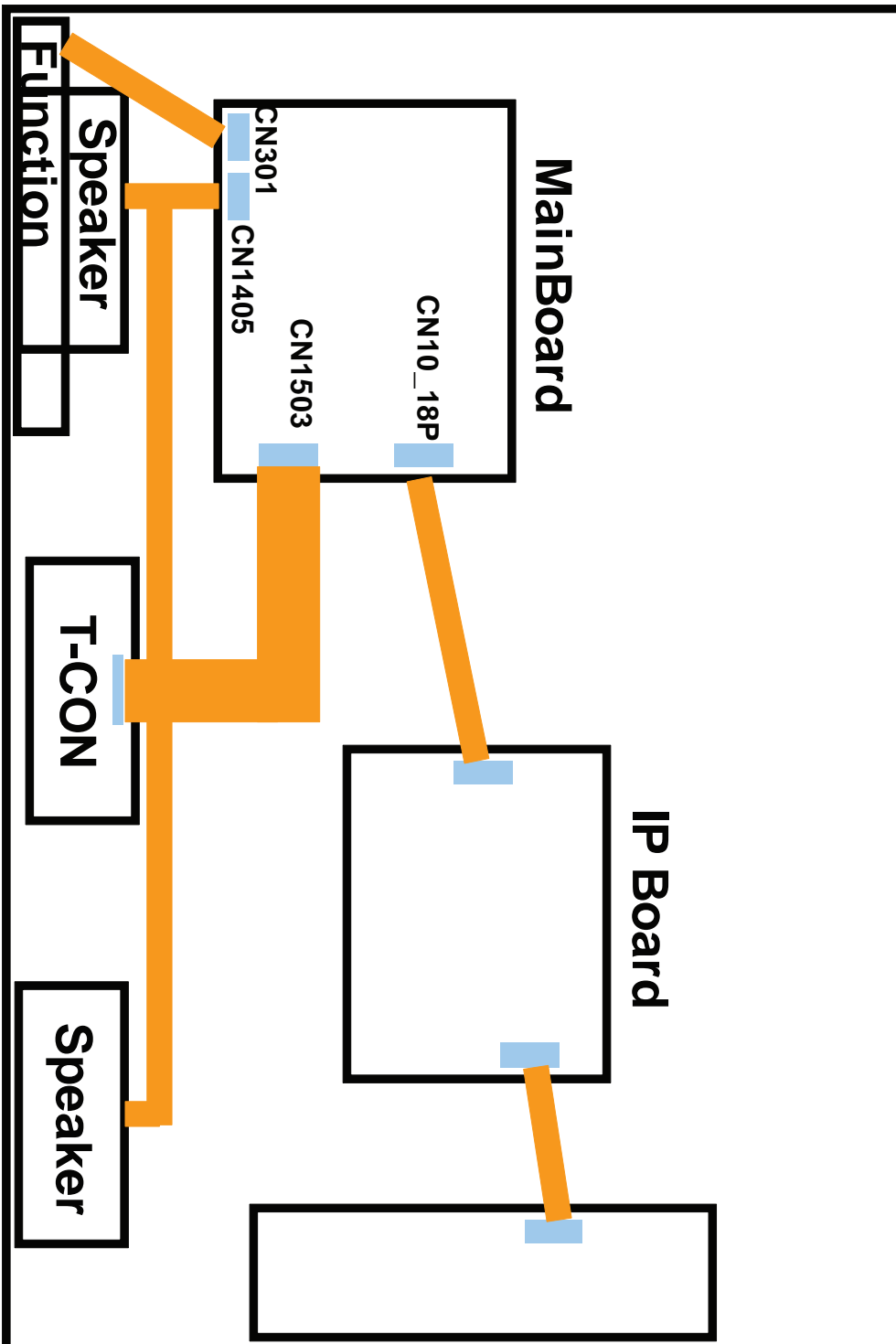

6-2. Connector

FCN402 (to Panel) C550/C540(40"/46")/C530			
1	NC	27	EVEN[0]-
2	NC	28	GND
3	NC	29	ODD[4]+
4	NC	30	ODD[4]-
5	NC	31	ODD[3]+
6	NC	32	ODD[3]-
7	FORMAT	33	GND
8	SDA_Panel	34	ODDCLK+
9	TCON_WP	35	ODDCLK-
10	NC	36	GND
11	SDA_Panel	37	ODD[2]+
12	SCL_Panel	38	ODD[2]-
13	GND	39	ODD[1]+
14	EVEN[4]+	40	ODD[1]-
15	EVEN[4]-	41	ODD[0]+
16	EVEN[3]+	42	ODD[0]-
17	EVEN[3]-	43	GND
18	GND	44	GND
19	EVENCLK+	45	GND
20	EVENCLK-	46	NC
21	GND	47	Panel_VCC
22	EVEN[2]+	48	Panel_VCC
23	EVEN[2]-	49	Panel_VCC
24	EVEN[1]+	50	Panel_VCC
25	EVEN[1]-	51	Panel_VCC
26	EVEN[0]+		

ZCN1303_HD(to Panel) C540(32")/C450			
1	Panel_VCC	16	ODD[CLK]+
2	Panel_VCC	17	ODD[CLK]-
3	Panel_VCC	18	GND
4	Panel_VCC	19	ODD[2]+
5	Panel_VCC	20	ODD[2]-
6	GND	21	GND
7	GND	22	ODD[1]+
8	GND	23	ODD[1]-
9	TCON_WP	24	GND
10	FORMAT	25	ODD[0]+
11	NC	26	ODD[0]-
12	GND	27	GND
13	ODD[3]+	28	SDA_TCON
14	ODD[3]-	29	SCL_TCON
15	GND	30	NC

CN202 (to Powr board)			
1	B12VS	10	GND
2	SW_POWER	11	GND
3	B12VS	12	H_OUT
4	A5V	13	B13V
5	B5V	14	PWM_DIMMING
6	B5V	15	B13V
7	B5V	16	SW_INVERTER
8	GND	17	B13V
9	GND	18	IP_DET

CN401(FUNCTION)			
1	IR	6	KEY_INPUT1
2	GND	7	KEY_INPUT2
3	A5V	8	LED_STB
4	MSCL	9	FUNC_9
5	MSDA	10	LED_CONTROL

CN501(LAN) C550			
1	LAN_TX-	5	LAN_VCC
2	GND	6	LAN_RX-
3	LAN_TX+	7	NC
4	LAN_RX+	8	GND

CN901(PC)			
1	PC_RED	9	PC_5V
2	PC_GREEN	10	IDENT_PC
3	PC_BLUE	11	R_FANET
4	T_FANET	12	SDA_DOWN
5	GND	13	PC_HS
6	GND	14	PC_VS
7	GND	15	SCL_DOWN
8	GND		

CN902(PC/DIV SOUND)			
1	GND	4	NC
2	PC_SR_IN	5	NC
3	PC_SL_IN	6	NC

CN903(DEBUG)			
1	GND	4	DEBUG_TX
2	DEBUG_RX	5	DEBUG_TX
3	DEBUG_TX	6	GND

CN701(UNIVERSAL JACK)			
1	GND	16	GND
2	COM2_SL	17	COMP1_SL
3	COM2_SR	18	COMP1_SR
4	GND	19	GND
5	COMP2_SR	20	COMP1_SR
6	COMP2_SL	21	COMP1_SL
7	GND	22	GND
8	COMP2_PR	23	COMP1_PR
9	COMP2_PR	24	COMP1_PR
10	GND	25	GND
11	COMP2_PB	26	IDENT_COMP1
12	COMP2_PB	27	COMP1_PB
13	GND	28	GND
14	IDENT_COMP2	29	IDENT_AV
15	COMP2_Y	30	COMP1_Y

CN1202 (SPEAKER)			
1	R+	3	L+
2	R-	4	L-

CN705_2U (REAR USB) C550			
1	USB_VCC	3	USB_DP
2	USB_DM	4	GND

CN706 (SIDE USB)			
1	USB_VCC	3	USB_DP
2	USB_DM	4	GND

CN704 (SIDE AV) C550/C540/C30			
1	GND	6	SL_IN
2	IDENT_AV	7	GND
3	CVBS	8	SL_IN
4	GND	9	SR_IN
5	SR_IN		

CN1002 (HDMI1)			
1	HDMI1_RX2+	11	GND
2	GND	12	HDMI1_RXCLK-
3	HDMI1_RX2-	13	HDMI_CEC
4	HDMI1_RX1+	14	GND
5	GND	15	SCL
6	HDMI1_RX1-	16	SDA
7	HDMI1_RX0+	17	GND
8	GND	18	5V
9	HDMI1_RX0-	19	HPD
10	HDMI1_RXCLK+		

CN1003 (HDMI2)			
1	HDMI2_RX2+	11	GND
2	GND	12	HDMI2_RXCLK-
3	HDMI2_RX2-	13	HDMI_CEC
4	HDMI2_RX1+	14	GND
5	GND	15	SCL
6	HDMI2_RX1-	16	SDA
7	HDMI2_RX0+	17	GND
8	GND	18	5V
9	HDMI2_RX0-	19	HPD
10	HDMI2_RXCLK+		

CN1004 (HDMI3) C550/C540			
1	HDMI3_RX2+	11	GND
2	GND	12	HDMI3_RXCLK-
3	HDMI3_RX2-	13	HDMI_CEC
4	HDMI3_RX1+	14	GND
5	GND	15	SCL
6	HDMI3_RX1-	16	SDA
7	HDMI3_RX0+	17	GND
8	GND	18	5V
9	HDMI3_RX0-	19	HPD
10	HDMI3_RXCLK+		

CN1001 (SIDE HDMI4)			
1	HDMI4_RX2+	11	GND
2	GND	12	HDMI4_RXCLK-
3	HDMI4_RX2-	13	HDMI_CEC
4	HDMI4_RX1+	14	GND
5	GND	15	SCL
6	HDMI4_RX1-	16	SDA
7	HDMI4_RX0+	17	GND
8	GND	18	5V
9	HDMI4_RX0-	19	HPD
10	HDMI4_RXCLK+		

CN1201 (MONITOR OUT)			
1	GND	5	NC
2	OUT_R	6	GND
3	OUT_R	7	NC
4	GND		

6-3. Connector Functions

Connector	Functions
Main CN201 ↔ IP CN802	Supply main power and dimming signal from IP board to Main Board.
Main CN1302/ZCN1303_HD ↔ T-CON CNF1	The LVDS signal transferred from Main Board to Panel .
IP CN803 ↔ Panel CN1 (14 Pin)	Supply power from IP board to Driver Board.
IP CN1802 ↔ Panel CN1 (2 Pin)	Supply power from IP board to Driver Board.
IP CN1801 ↔ Panel CN3 (7 Pin)	Supply power from IP board to Driver Board.

6-4. Cables

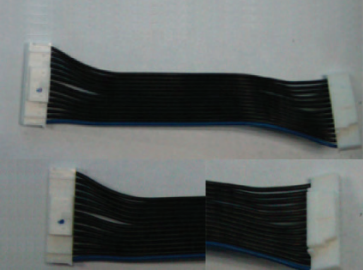
Use	LEAD (Main-IP 18P)	LEAD (Inverter 14P)
Code	26" : BN39-01267L(125mm) 32" : BN39-01267A(200mm)	26" : BN39-01274A(80mm) 32" : BN39-01274A(80mm)
Photo		

Use	LVDS (Main - TCON)		
Code	BN96-12453D	26" : BN96-12469D	32" : BN96-13227A
Photo	