



SANYO Semiconductors

## DATA SHEET

# LA4265 — Monolithic Linear IC

## 3.5W Monaural Power Amplifier

### Overview

LA4265 is a 3.5W monaural power amplifier.

### Features

- Minimum number of external parts required (No input capacitor, bootstrap capacitor required).
- High output : 3.5W typ ( $V_{CC} = 16V$ ,  $R_L = 8\Omega$ , THD = 10%).
- Soft clip, causing little harmonic disturbance to radios.
- Small pop noise at the time of power switch ON/OFF.
- Built-in protector against abnormal modes (Thermal shutdown, overvoltage)

### Specifications

#### Absolute Maximum Ratings at $T_a = 25^\circ C$

Parameter	Symbol	Conditions	Ratings	Unit
Maximum supply voltage	$V_{CC}$ max		25	V
Maximum output current	$I_O$ Peak		2	A
Allowable power dissipation	$P_d$ max	With $100 \times 120 \times 1.5 \text{mm}^2$ Al heat sink	7.5	W
Operating temperature	$T_{opr}$		-20 to +75	$^\circ C$
Storage temperature	$T_{stg}$		-40 to +150	$^\circ C$

#### Operating Conditions at $T_a = 25^\circ C$

Parameter	Symbol	Conditions	Ratings	Unit
Recommended supply voltage	$V_{CC}$		16	V
Recommended load resistance	$R_L$		8	$\Omega$
Operating supply voltage range	$V_{CC}$		9 to 24	V

■ Any and all SANYO Semiconductor Co.,Ltd. products described or contained herein are, with regard to "standard application" intended for the use as general electronics equipment (home appliances, AV equipment, communication device, office equipment, industrial equipment etc.). The products mentioned herein shall not be intended for use for any "special application" (medical equipment whose purpose is to sustain life, aerospace instrument, nuclear control device, burning appliances, transportation machine, traffic signal system, safety equipment, etc.) that shall require extremely high level of reliability and can directly threaten human lives in case of failure or malfunction of the product or may cause harm to human bodies, nor shall they grant any guarantee thereof. If you should intend to use our products for applications outside the standard applications of our customer or who is considering such use and/or outside the scope of our intended standard applications, please consult with us prior to the intended use. If there is no consultation or inquiry before the intended use, our customer shall be solely responsible for the use.

■ Specifications of any and all SANYO Semiconductor Co.,Ltd. products described or contained herein stipulate the performance, characteristics, and functions of the described products in the independent state, and are not guarantees of the performance, characteristics, and functions of the described products as mounted in the customer's products or equipment. To verify symptoms and states that cannot be evaluated in an independent device, the customer should always evaluate and test devices mounted in the customer's products or equipment.

SANYO Semiconductor Co., Ltd.

[www.semiconductor-sanyo.com/network](http://www.semiconductor-sanyo.com/network)

# LA4265

**Electrical Characteristics** at  $T_a = 25^\circ\text{C}$ ,  $V_{CC} = 16\text{V}$ ,  $R_L = 8\Omega$ ,  $f = 1\text{kHz}$ ,  $R_g = 600\Omega$ , See specified test circuit (based on sample application circuit).

Parameter	Symbol	Conditions	Ratings			Unit
			min	typ	max	
Quiescent current	$I_{CCO}$			35	50	mA
Voltage gain	VG		48	50	52	dB
Output power	$P_O$	THD = 10%	3.0	3.5		W
Total harmonic distortion	THD	$P_O = 0.5\text{W}$		0.3	1.0	%
Output noise voltage	$V_{NO}$	$R_g = 10\text{k}\Omega$ , BPF = 20Hz to 20kHz		0.65	1.5	mV
Ripple rejection	SVRR	$R_g = 0$ , $f_R = 100\text{Hz}$ , $V_R = 0.5\text{V}$	40	50		dB

## Package Dimensions

unit : mm (typ)

3018B

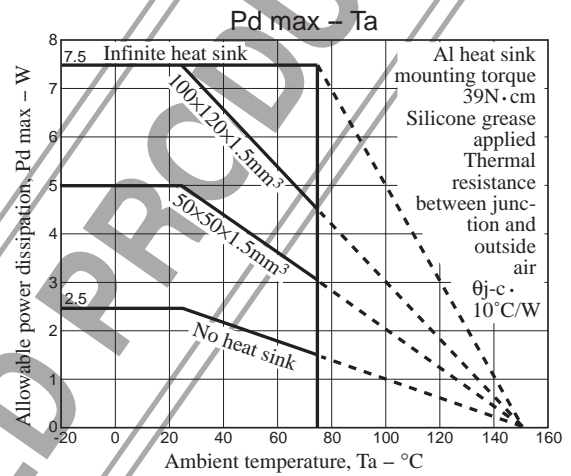
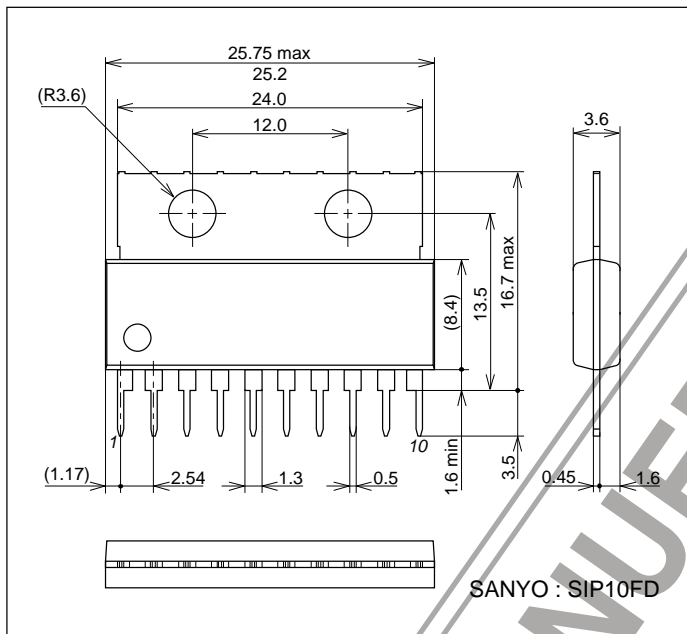

## Block Diagram

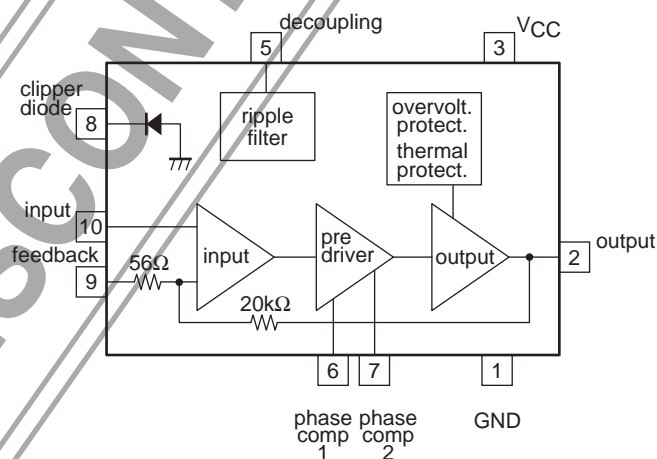

# LA4265

## Sample Application Circuit 1

(Recommended circuit)

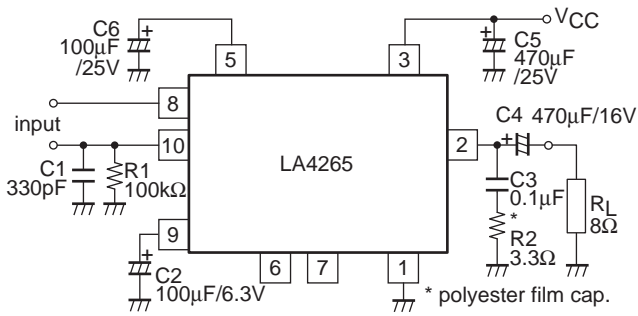

## Sample Application Circuit 2

(Circuit with minimum number of external parts)

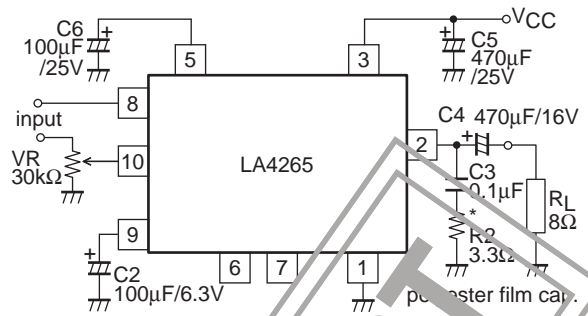

## Sample Printed Circuit Pattern

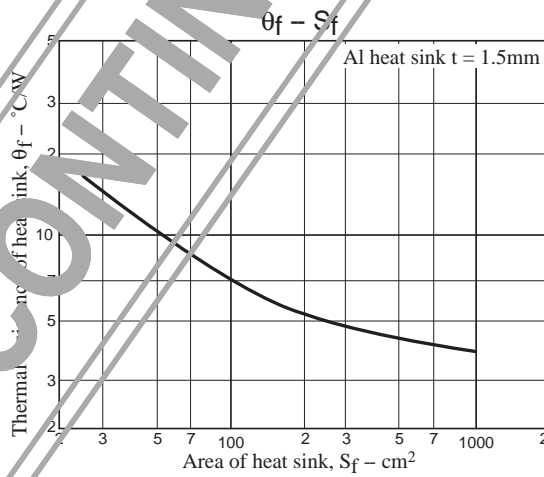
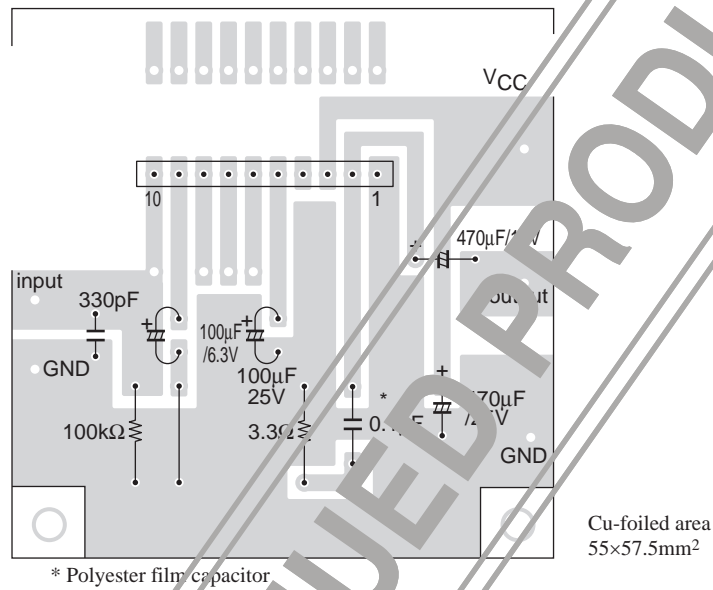

## Description of External Parts

- C1 (330pF) : Input short capacitor.  
Reduces the high frequency noise when the input impedance is increased. Not required when the input impedance is decreased.
- C2 (100 $\mu$ F) : Feedback capacitor.  
Decreasing the capacitance value lowers the low frequency response. Increasing the capacitance value makes the starting time later.
- C3 (0.1 $\mu$ F polyester film capacitor) : Oscillation blocking capacitor.  
Decreasing the capacitance value causes oscillation to occur easily. Use a polyester film capacitor that is good in high frequency response and temperature characteristic. The use of an electrolytic capacitor may cause oscillation to occur at low temperatures.
- C4 (470 $\mu$ F) : Output capacitor.  
Decreasing the capacitance value causes insufficient power at low frequencies.
- C5 (470 $\mu$ F) : Power capacitor.  
Decreasing the capacitance value causes ripple to occur easily. Locating at a distance from the IC or removing this capacitor may cause oscillation to occur.
- C6 (100 $\mu$ F) : Ripple filter capacitor.  
Decreasing the capacitance value excessively or removing this capacitor causes ripple to occur. However, increasing the capacitance value does not always cause ripple to be reduced. Decreasing the capacitance value makes the starting time earlier.
- R1 (100k $\Omega$ ) : Input bias resistor.  
Determines the bias (bias of zero potential) to be applied to the input pin and the input impedance. Not required if a variable resistor is also used as this resistor.
- R2 (3.3 $\Omega$ ) : Resistor connected in series with oscillation blocking capacitor.  
Prevents phase shift attributable to the oscillation blocking capacitor so that oscillation is hard to occur.

## Note for Changing Voltage Gain

The voltage gain can be reduced by adding an external resistor ( $R_{NF}$ ) in series with the feedback capacitor. (See  $V_G \cdot R_{NF}$  characteristic curve). However, it should be noted that various characteristics are also changed (THD-VG,  $V_{NO}$ -VG,  $V_{ro}$ -VG). The voltage gain must not be reduced to be less than 30dB. Since the frequency response is extended and oscillation is liable to occur when the voltage gain is reduced, high-cut must be made as required. (High-cut is made by connecting a capacitor of approximately 30pF across pins (6) and (7).)

## External Muting

If external muting is required, make the circuit as shown on next page. In this case, the pop noise is similar to that which occurs at the time of power switch ON/OFF. If the value of the series resistor is decreased, more pop noise is heard at the time of attack ; if increased, muting is hard to work.

## Measure against Fold-back of Output Waveform

Since the input pin is zero-biased, the circuit may be saturated at an overinput, causing a part of the output waveform to be folded back (e. g. when the peak input voltage exceeds 600mV). In such a case, the fold-back of the waveform can be prevented by using the built-in diode (also can be prevented by using an external diode). When the built-in diode is used, a resistor must be connected in series with the input pin to cause the diode to conduct no overcurrent (10mA or less).

Fold-back Output Waveform

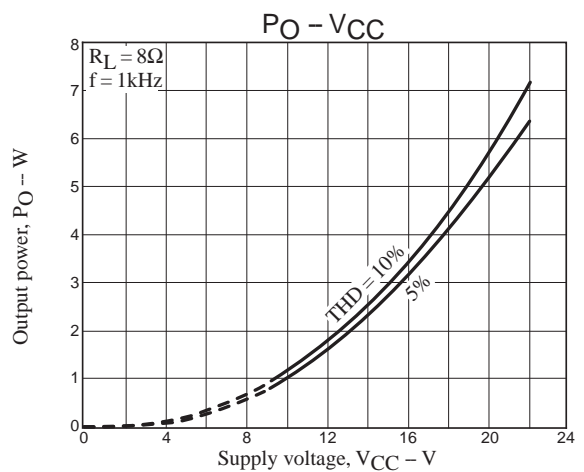
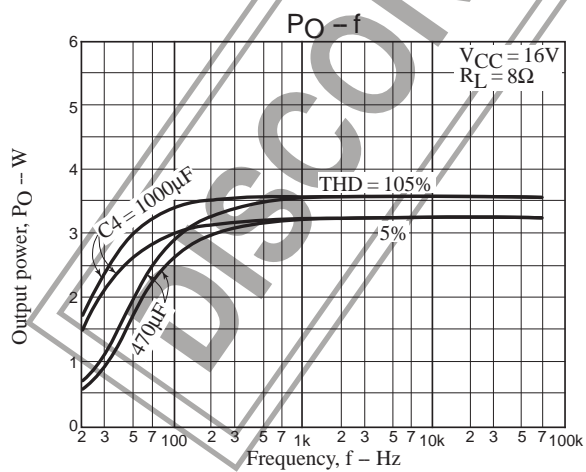
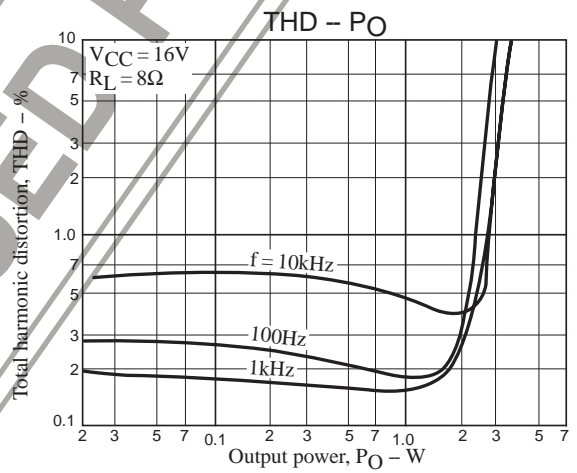
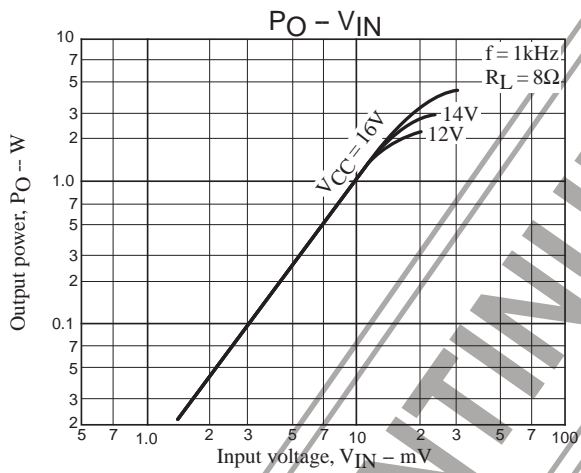
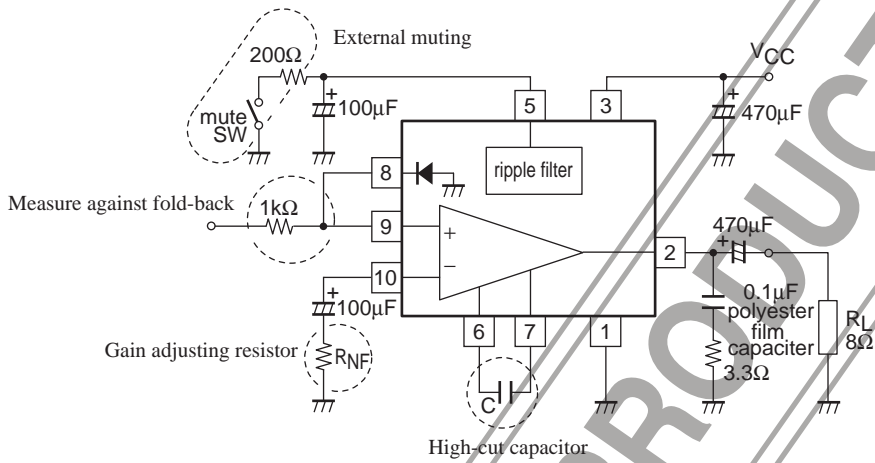
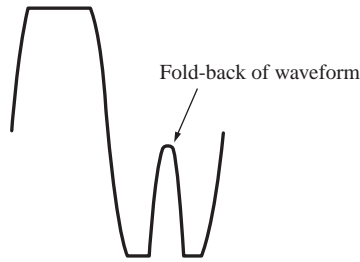

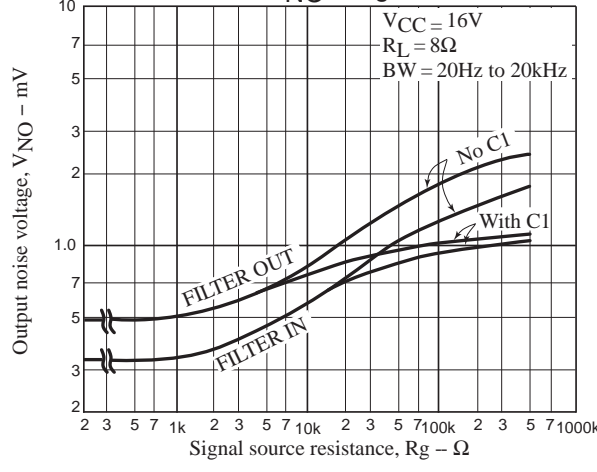
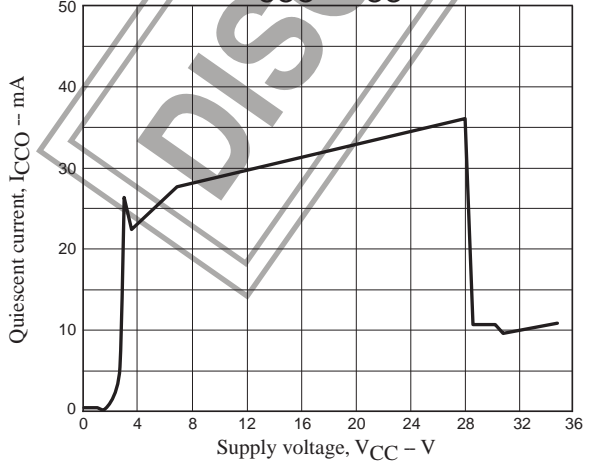
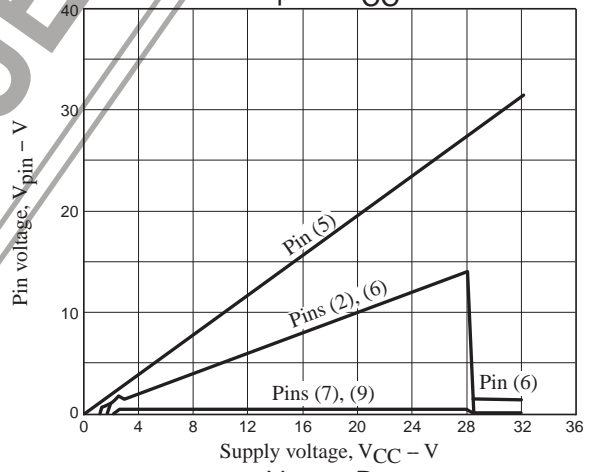
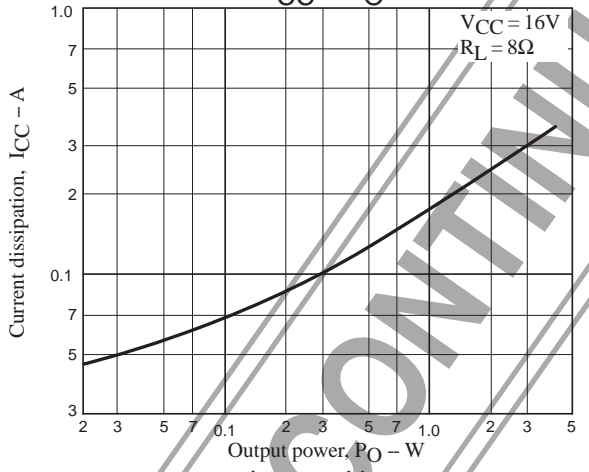
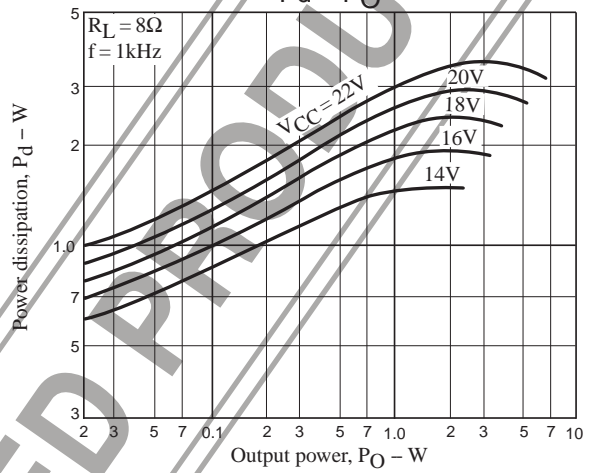
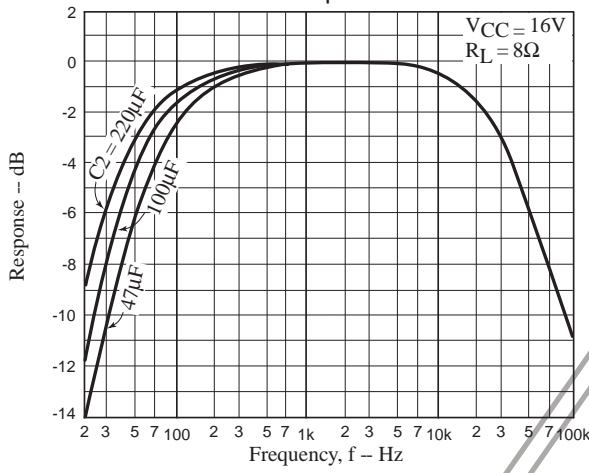
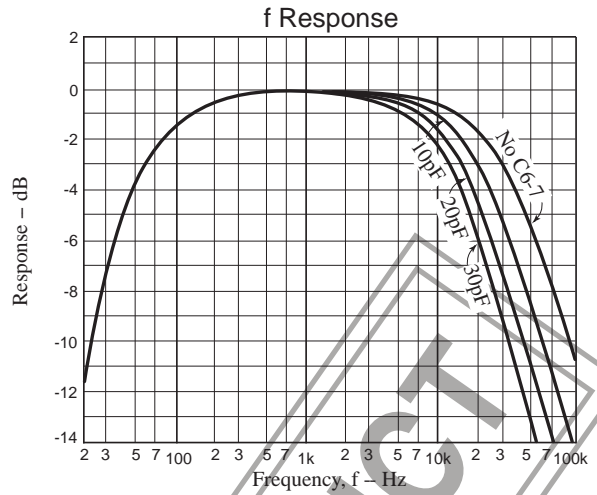
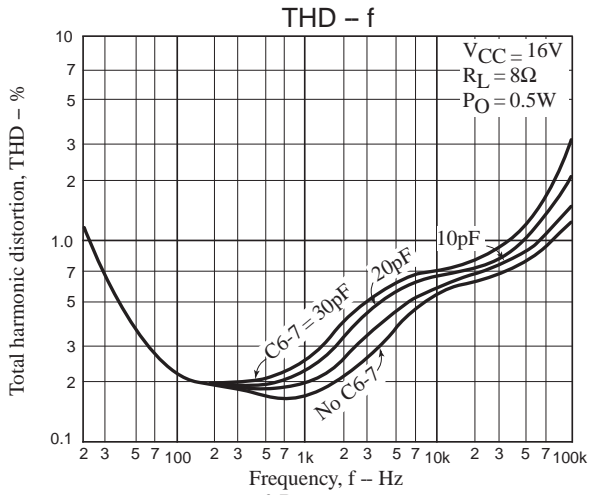

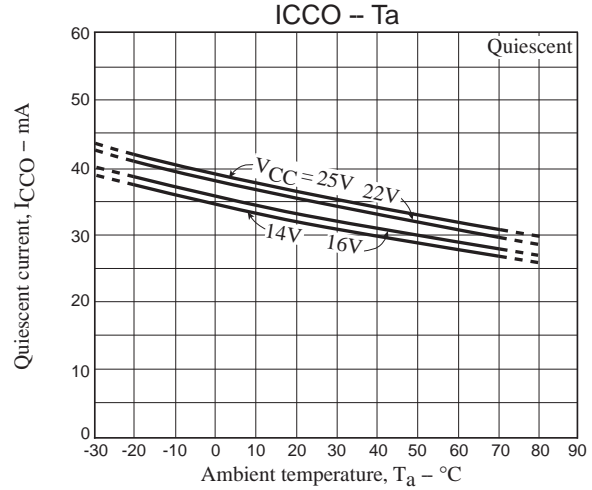
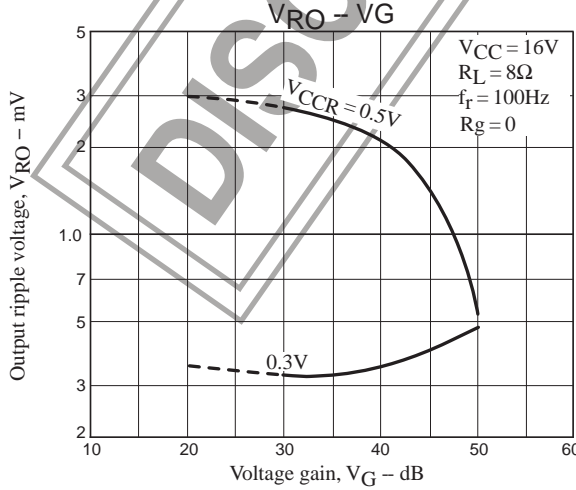
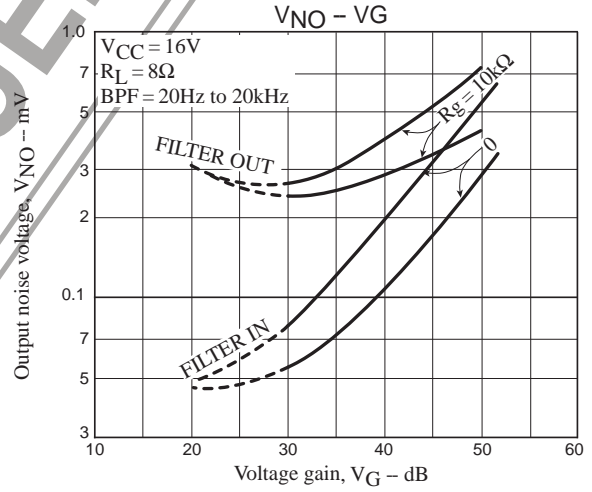
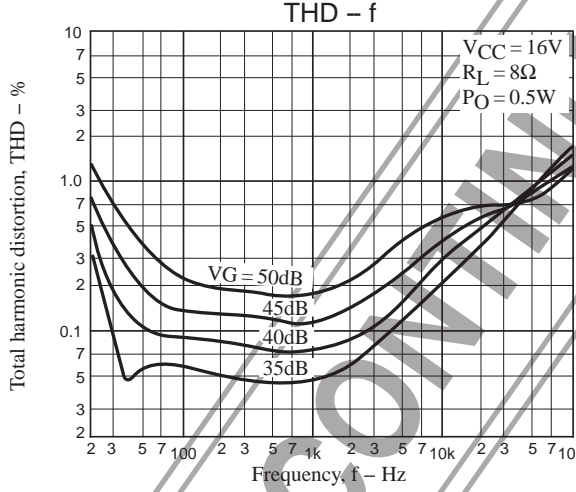
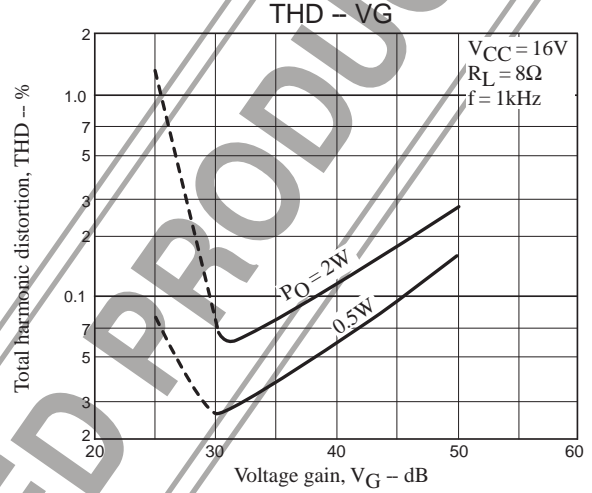
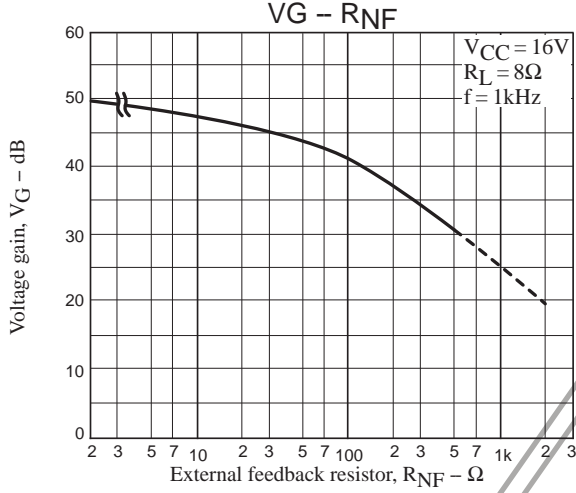
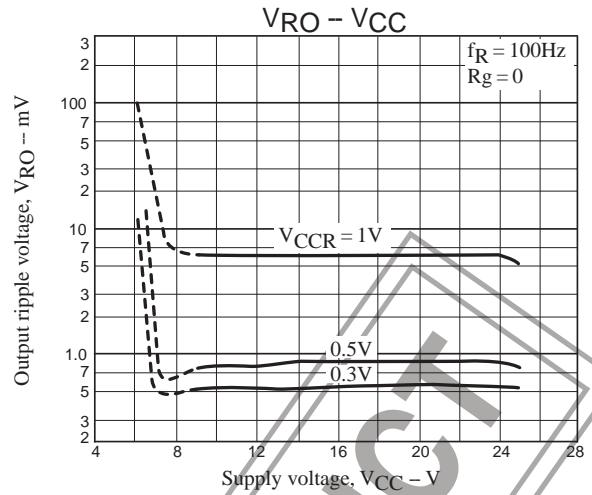
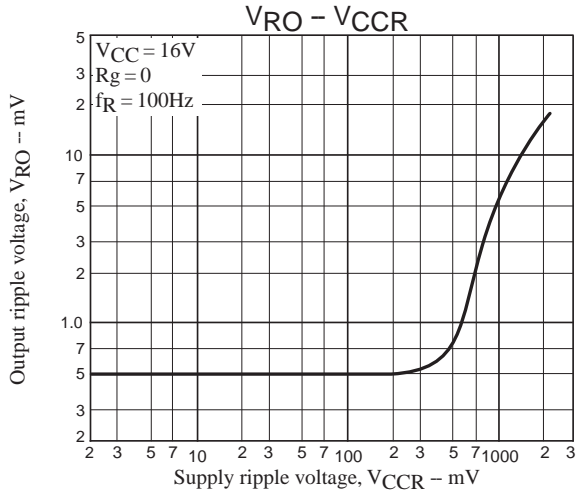



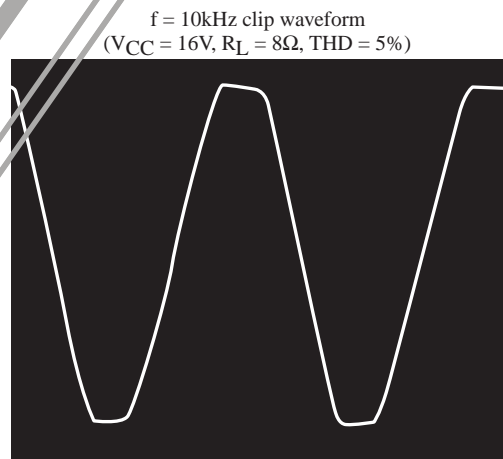
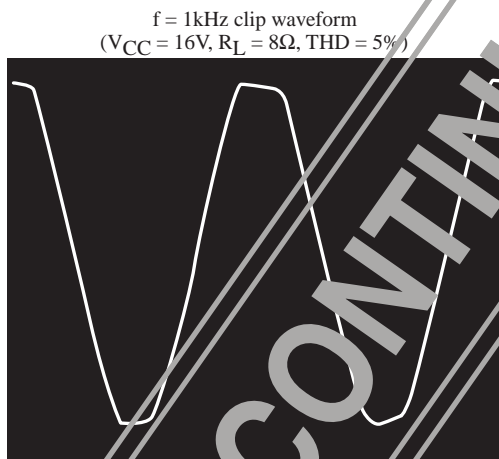
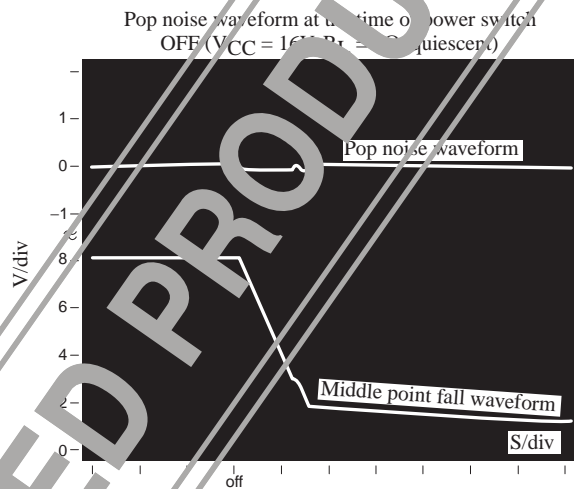
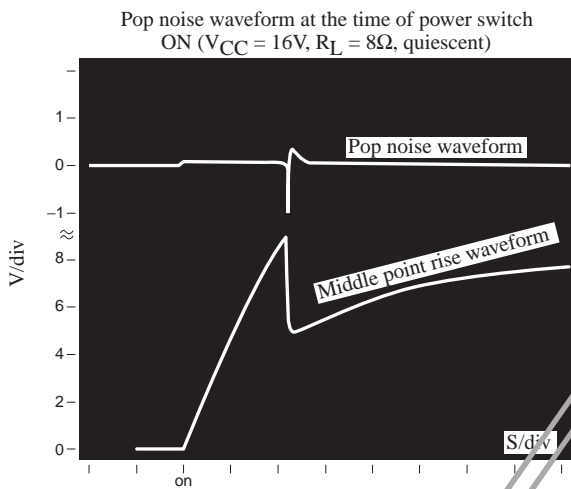
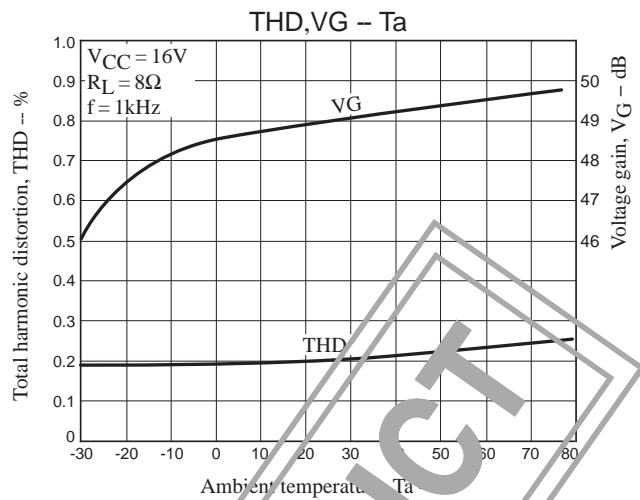
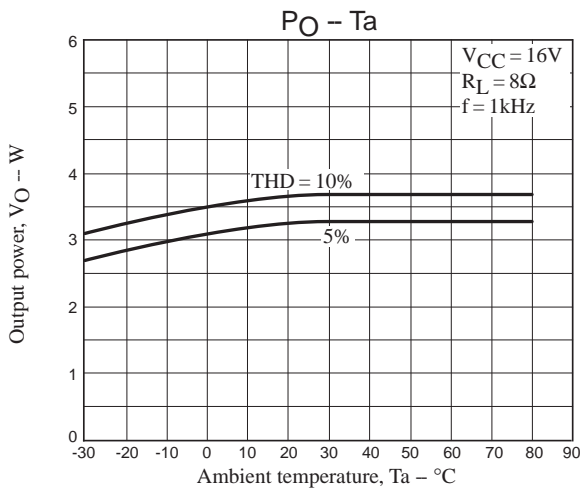

**Proper Cares in Using IC**

- Maximum ratings  
 If the IC is used in the vicinity of the maximum ratings, even a slight variation in conditions may cause the maximum ratings to be exceeded, thereby leading to breakdown. Allow an ample margin of variation for supply voltage, etc. and use the IC in the range where the maximum ratings are not exceeded.
- Pin-to-pin short  
 If power is applied when the space between pins is shorted, breakdown or deterioration may occur. When mounting the IC on the board or applying power, make sure that the space between pins is not shorted with solder, etc.
- When used in radio applications  
 When using in radios, allow a sufficient space between IC and bar antenna.



- Printed circuit pattern

When designing the printed circuit pattern, make the power supply, output, and ground lines thick and short and arrange the pattern and parts so that no feedback loop is formed between input and output. Place power capacitor C5, oscillation blocking capacitor C3 as close to IC pins as possible to prevent oscillation from occurring. Refer to the sample printed circuit pattern.

- Some plug jacks to be used for connecting to the external speaker can have the both poles short-circuited once when connecting. In this case, the load is short-circuited, which may break down the IC.

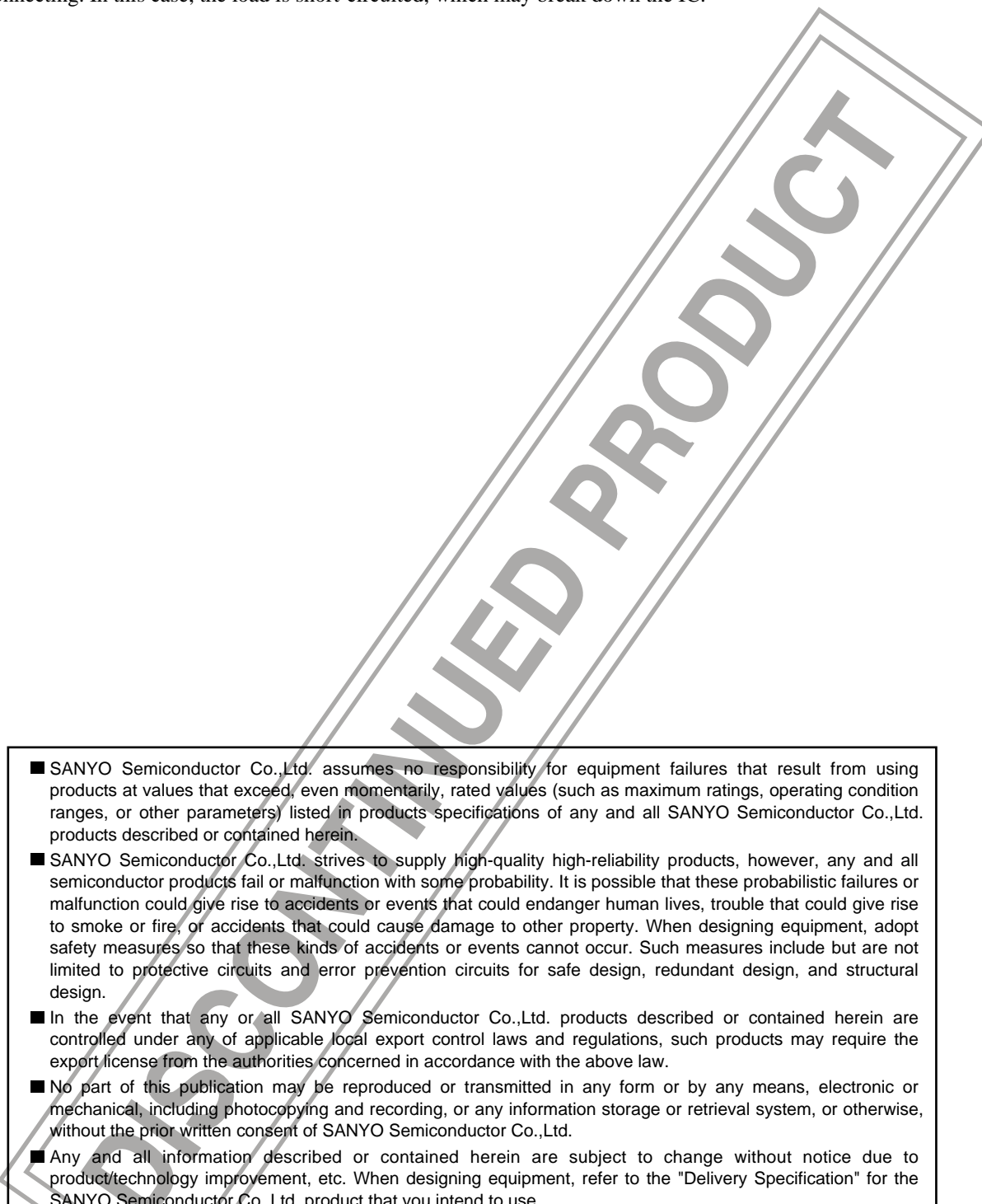
- 
- SANYO Semiconductor Co.,Ltd. assumes no responsibility for equipment failures that result from using products at values that exceed, even momentarily, rated values (such as maximum ratings, operating condition ranges, or other parameters) listed in products specifications of any and all SANYO Semiconductor Co.,Ltd. products described or contained herein.
  - SANYO Semiconductor Co.,Ltd. strives to supply high-quality high-reliability products, however, any and all semiconductor products fail or malfunction with some probability. It is possible that these probabilistic failures or malfunction could give rise to accidents or events that could endanger human lives, trouble that could give rise to smoke or fire, or accidents that could cause damage to other property. When designing equipment, adopt safety measures so that these kinds of accidents or events cannot occur. Such measures include but are not limited to protective circuits and error prevention circuits for safe design, redundant design, and structural design.
  - In the event that any or all SANYO Semiconductor Co.,Ltd. products described or contained herein are controlled under any of applicable local export control laws and regulations, such products may require the export license from the authorities concerned in accordance with the above law.
  - No part of this publication may be reproduced or transmitted in any form or by any means, electronic or mechanical, including photocopying and recording, or any information storage or retrieval system, or otherwise, without the prior written consent of SANYO Semiconductor Co.,Ltd.
  - Any and all information described or contained herein are subject to change without notice due to product/technology improvement, etc. When designing equipment, refer to the "Delivery Specification" for the SANYO Semiconductor Co.,Ltd. product that you intend to use.
  - Information (including circuit diagrams and circuit parameters) herein is for example only; it is not guaranteed for volume production.
  - Upon using the technical information or products described herein, neither warranty nor license shall be granted with regard to intellectual property rights or any other rights of SANYO Semiconductor Co.,Ltd. or any third party. SANYO Semiconductor Co.,Ltd. shall not be liable for any claim or suits with regard to a third party's intellectual property rights which has resulted from the use of the technical information and products mentioned above.

This catalog provides information as of August, 2008. Specifications and information herein are subject to change without notice.