



LA4422

5.8W typ AF Power Amplifier for Car Stereos, Car Radios

Features

- High gain (53dB typ.) and high output (5.8W typ).
- Soft clip.
- Small number of external parts (4 pcs).
- Bridge construction usable ($P_O=18W/R_L=4\Omega$).
- Built-in thermal shutdown circuit against load short, overload.
- Built-in circuit to prevent pop noise at the time of power supply ON.
- SIP package (single ended pins) facilitating easy mounting.

Package Dimensions

unit:mm

3018A-SIP10FD

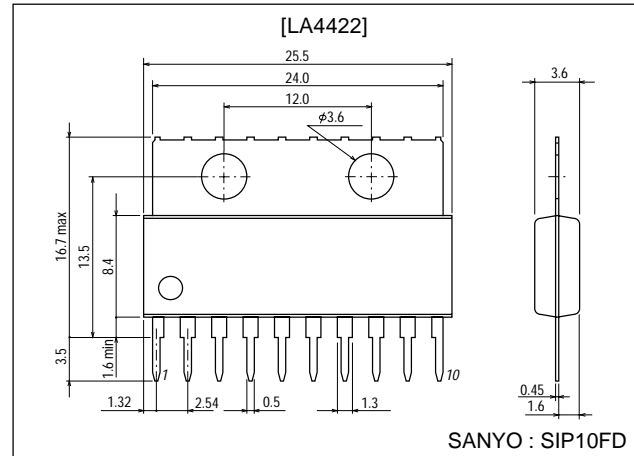

Specifications

Absolute Maximum Ratings at $T_a = 25^\circ\text{C}$

Parameter	Symbol	Conditions	Ratings	Unit
Maximum supply voltage	$V_{CC\text{ max}}$		18	V
Maximum output current	I_O	Pin 1 flow-in, pin 8 flow-out, Pin 10 flow-out *	4.5	A
Surge supply voltage	V_{surge}	$t \leq 0.2\text{s}$	40	V
Allowable power dissipation	$P_d\text{ max}$		7	W
Operating temperature	T_{opr}		-20 to +75	$^\circ\text{C}$
Storage temperature	T_{stg}		-40 to +150	$^\circ\text{C}$

* : 100×100×1.5mm³ Al heat sink used.Operating Conditions at $T_a = 25^\circ\text{C}$

Parameter	Symbol	Conditions	Ratings	Unit
Recommended supply voltage	V_{CC}		13.2	V
Recommended load resistance	R_L		4	Ω

Operating Characteristics at $T_a = 25^\circ\text{C}$, $V_{CC}=13.2\text{V}$, $R_L=4\Omega$, $f=1\text{kHz}$, 100×100×1.5mm³ Al heat sink.

Parameter	Symbol	Conditions	Ratings			Unit
			min	typ	max	
Quiescent current	I_{CCO}			35	80	mA
Voltage gain	VG	Closed loop	51	53	55	dB
		Open loop based on specified circuit		70		dB
Output power	P_{O1}	THD=10%, $R_L=4\Omega$	5.0	5.8		W
	P_{O2}	THD=10%, $R_L=2\Omega$		9.0		W

Continued on next page

■ Any and all SANYO products described or contained herein do not have specifications that can handle applications that require extremely high levels of reliability, such as life-support systems, aircraft's control systems, or other applications whose failure can be reasonably expected to result in serious physical and/or material damage. Consult with your SANYO representative nearest you before using any SANYO products described or contained herein in such applications.

■ SANYO assumes no responsibility for equipment failures that result from using products at values that exceed, even momentarily, rated values (such as maximum ratings, operating condition ranges, or other parameters) listed in products specifications of any and all SANYO products described or contained herein.

SANYO Electric Co., Ltd. Semiconductor Company

TOKYO OFFICE Tokyo Bldg., 1-10, 1 Chome, Ueno, Taito-ku, TOKYO, 110-8534 JAPAN

21500TH (KT)/O281TS/D177KI/5085MW/6250KI, TS No.556-1/10

LA4422

Continued from preceding page.

Parameter	Symbol	Conditions	Ratings			Unit
			min	typ	max	
Total harmonic distortion	THD	$P_O=1W$		0.7	2.0	%
Input resistance	ri			30		k Ω
Output noise voltage	V_{NO}	$R_g=10k\Omega$, no filter		1.2	2.5	mV

Equivalent Circuit Block Diagram

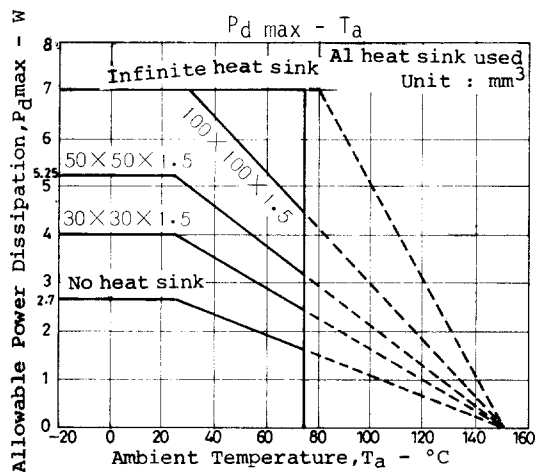
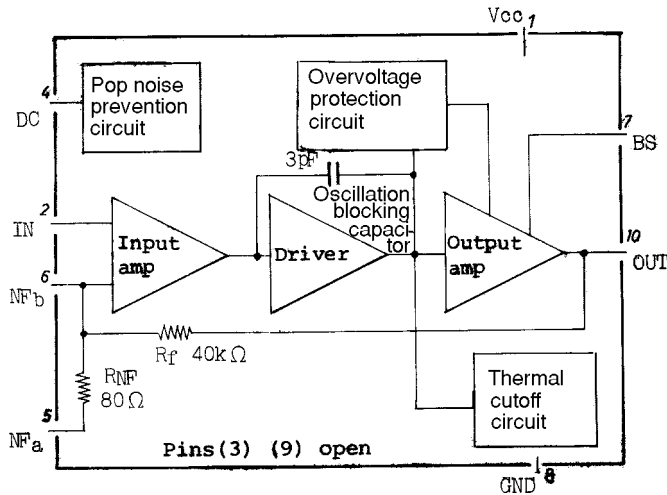

Proper Cares in Using IC

1. Maximum ratings

Extreme caution should be exercised when using the IC in the vicinity of the maximum ratings as a slight factor may cause the maximum ratings to be exceeded, thereby leading to a breakdown accident.

2. Pin-to-pin short

If the power supply is turned ON with pin-to-pin short, a breakdown or de-gradation may occur. When installing the IC on the board, be sure to check that pin-to-pin area is not shorted with solder, etc. and turn ON the power supply.

3. Printed Circuit Board

When designing the printed circuit board, make the power supply and ground lines thicker and shorter so that no feedback loop of input/output is formed. When using under the condition where the signal source impedance (R_g) is large, a stable operation against distortion is obtained by separating the input/output ground line at the root of GND pin [pin (8)]. The heat sink fin must be reliably connected to the external line of the same potential as pin (8) (GND).

Functions of External Parts

The recommended number of external parts of the LA4422 is 4 pcs. as follows.

- Feedback capacitor from pin (5) C_{NF} .
- Pin (7) to (10) bootstrap capacitor C_{BS} .
- Output capacitor from pin (10) C_{OUT} .
- High frequency parasitic oscillation compensating capacitor C_X .

The fixed values of these parts are $C_{NF}=100\mu F$, $C_{BS}=100\mu F$, $C_{OUT}=1000\mu F$, $C_X=0.15\mu F$. We now consider what will occur when these values are changed.

(a) Feedback capacitor C_{NF}

If C_{NF} is made smaller, the combined series impedance with R_{NF} at a low frequency is increased, the amplification degree A_{vf} is decreased, and the low cutoff frequency is made higher as seen from the following equation.

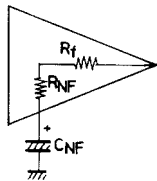

$$A_{vf} = \frac{R_f}{\left(R_{NF} + \frac{1}{j\omega C_{NF}} \right)}$$

$$VG = 20 \log A_{vf} \text{ (dB)}$$

The ripple rejection is also lowered. It is possible, however, to make the starting time earlier at the time of the power supply switch ON. If C_{NF} is made larger, these are reversed.

(b) Bootstrap capacitor C_{BS}

The low cutoff frequency may be somewhat influenced, but the drive at a low frequency is more influenced. If C_{BS} is made smaller, power at a low frequency may be reduced. Therefore, C_{BS} should be more than $47\mu F$.

(c) Output capacitor C_{OUT}

The low cutoff frequency may be somewhat influenced, but the most influence is that power is reduced as the impedance at a low frequency is increased. Therefore, C_{OUT} should be determined by the power band width. $470\mu F$ min. is required.

(d) High frequency parasitic oscillation compensating capacitor C_X .

C_X should be a polyester film capacitor of good frequency characteristic. If a ceramic capacitor is used, oscillation may occur.

Features of IC System and Functions of Remaining Pins

- Since the input circuit uses pnp and the input potential is designed to be 0 bias, no input coupling capacitor is needed and the direct coupling is available.
- The thermal shutdown protection circuit is built in to prevent breakdown or degradation attributable to generation of heat at the time of load short or overload.
- The overvoltage protection circuit is built in to protect the IC from breaking down when a surge is applied to the power supply line.
- The prevention circuit is provided to prevent pop noise which occurs when the power supply is turned ON.
- The voltage gain of open loop is lowered and the negative feedback is made smaller to obtain a soft clip. Radiation to the high frequency circuit and stability are considered.
- The feedback resistor R_f is set up at such a large value as $40k\Omega$ and the cutoff frequency point f_L is considered so that the frequency characteristic is fully extended to a low frequency even if the capacity of capacitor C_{NF} is small.
- The high frequency parasitic oscillation compensating capacitor is built in as a means to reduce the number of external parts. Therefore, the high cutoff frequency point f_H is fixed.
- The feedback resistor R_{NF} is built in and the voltage gain is fixed to be 53dB in order to reduce the number of external parts and to minimize the variations of voltage gain.
Pins (5) and (6) are provided to control the voltage gain externally. The voltage gain is lowered by inserting a resistor in series with pin (5). The voltage gain is increased by inserting a resistor between pin (5) and (6). If CR are connected to pin (6), the voltage gain is freely controlled through pin (6) alone.
- Pin (4) is provided as a decoupling pin.
Even if the power supply is turned ON/OFF in succession, pop noise is minimized by connecting a capacitor to this pin, provided that a condition $C_D \geq C_{NF}$ is recommended. C_{NF} is related to the starting time. The ripple rejection is improved by connecting the decoupling capacitor C_D .

LA4422

Sample Application Circuit 1. Power amplifier for 5.8W typ. car radio, car stereo

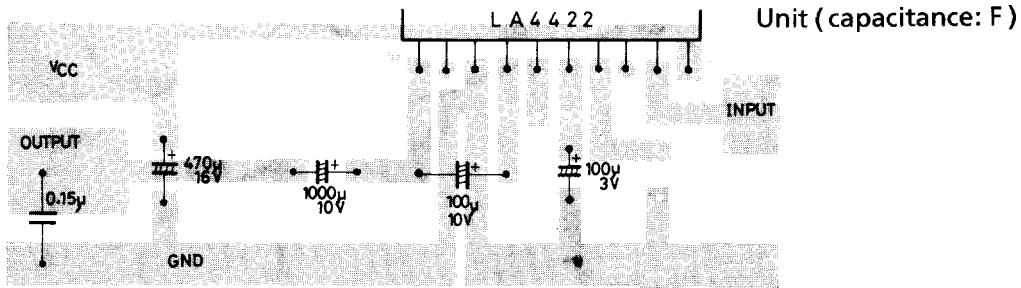
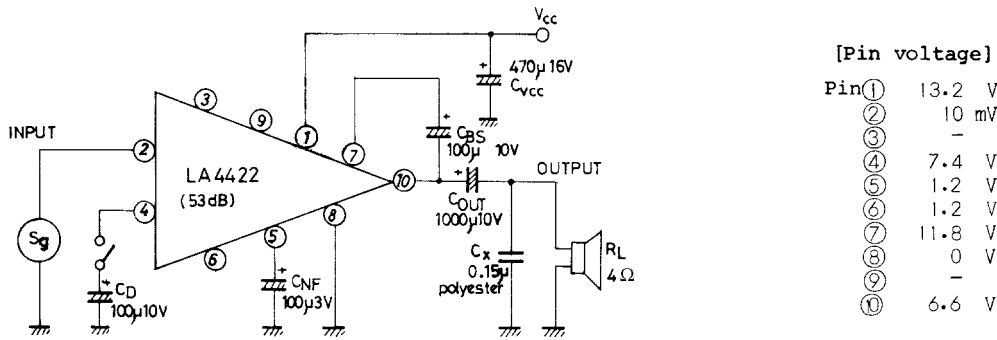

Printed Circuit Pattern (22 x 65mm², Cu-foiled side)

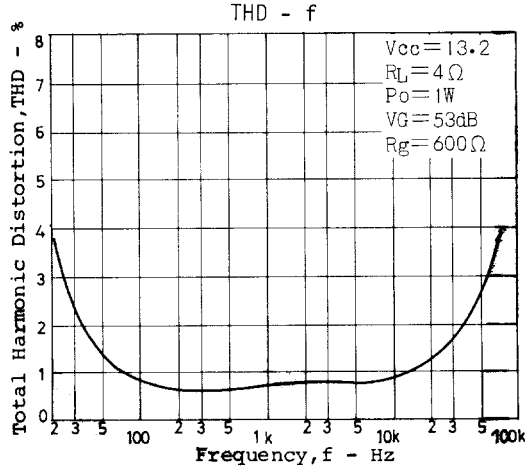
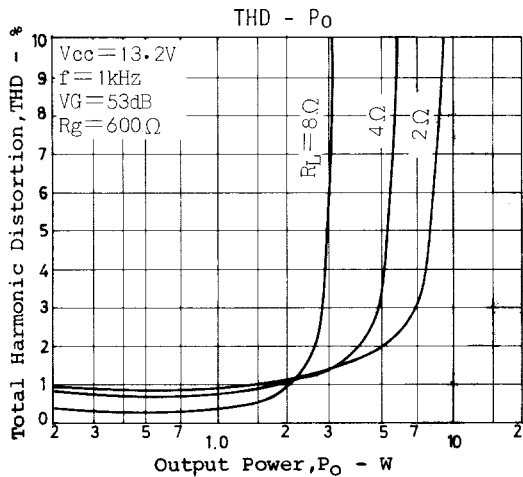
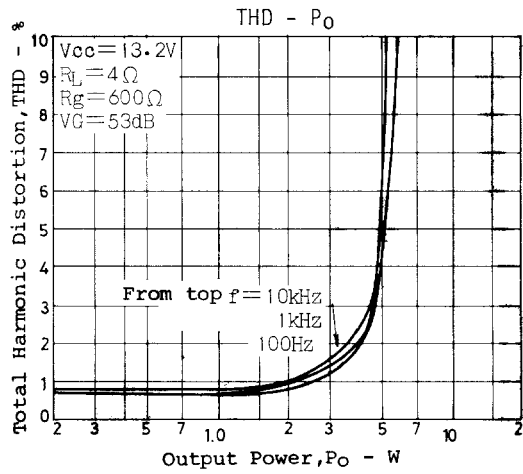
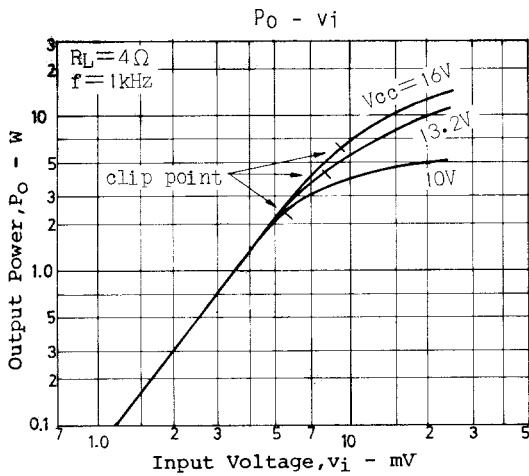

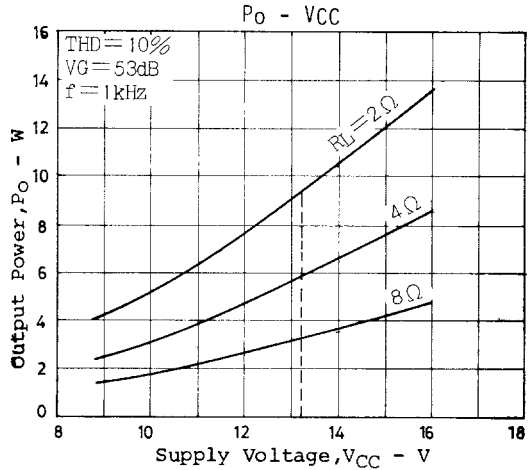
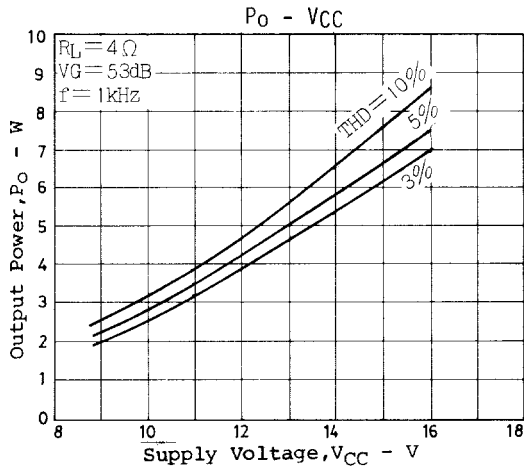
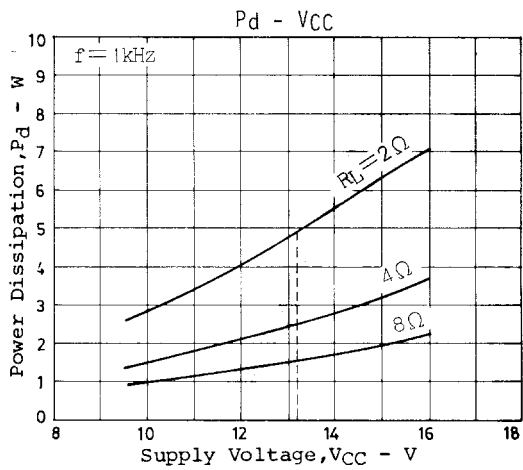
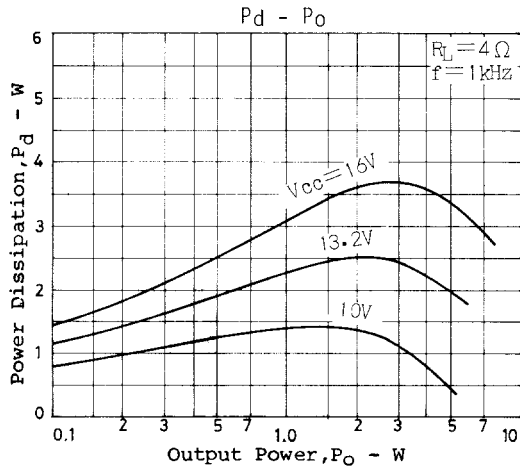
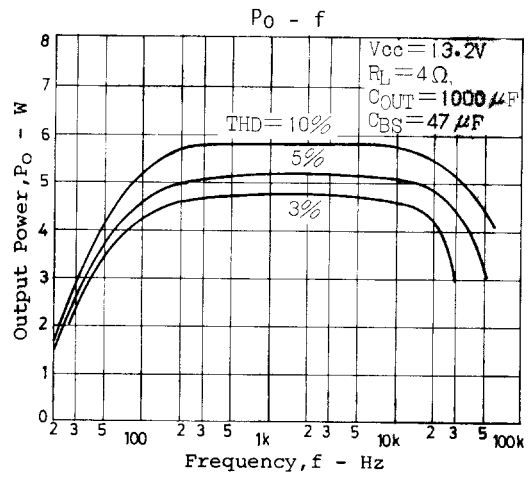
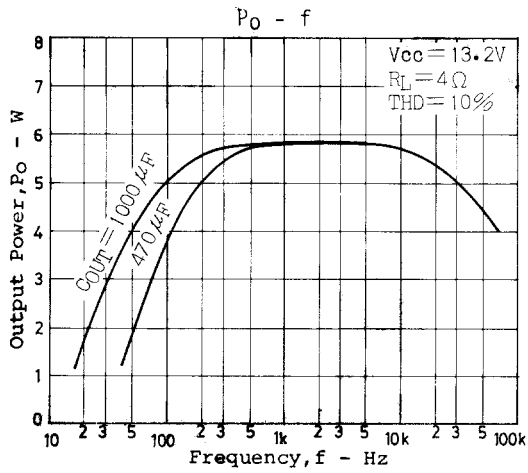
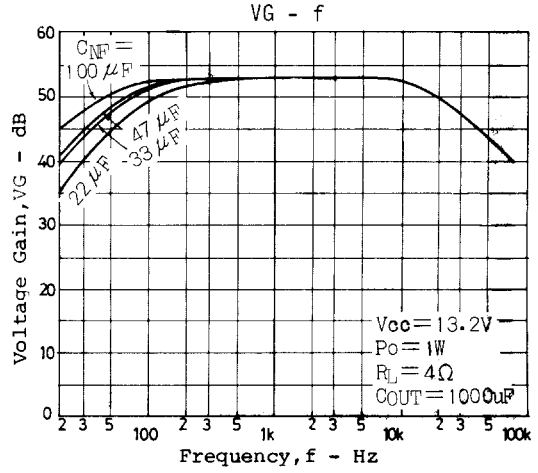
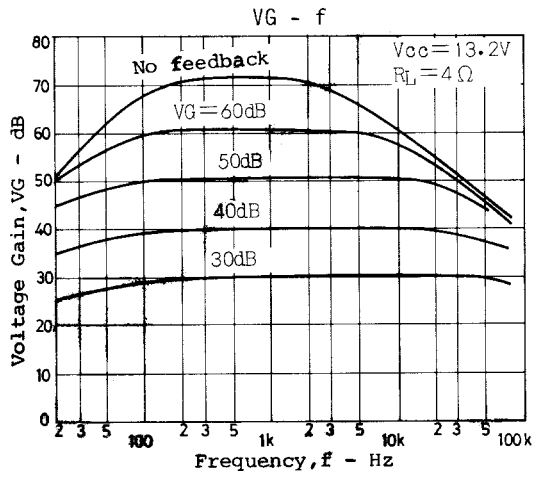

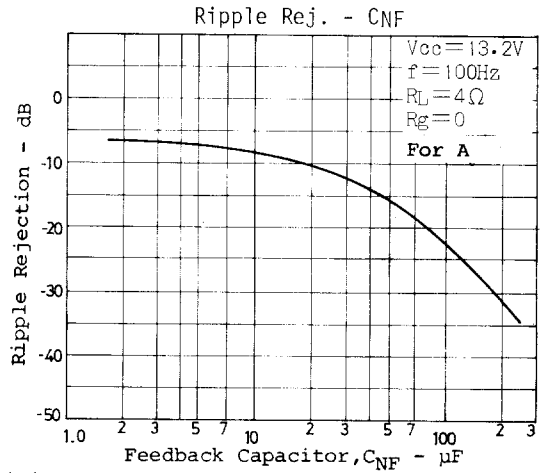
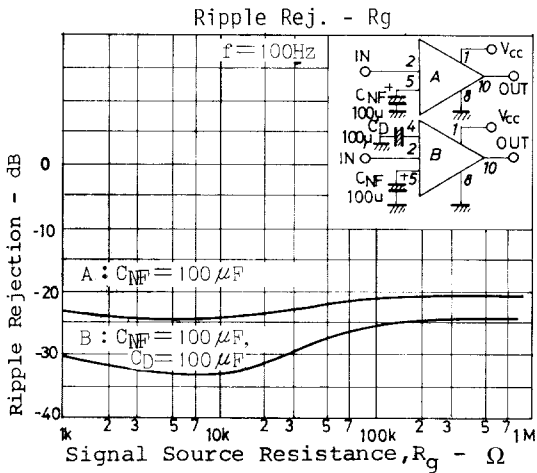
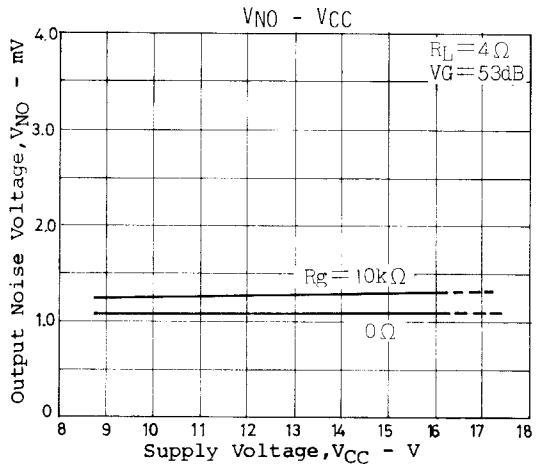
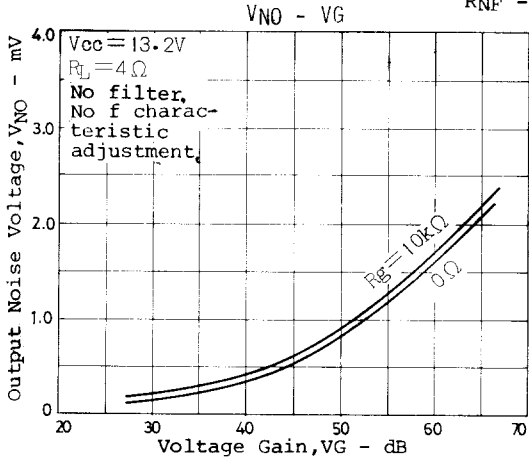
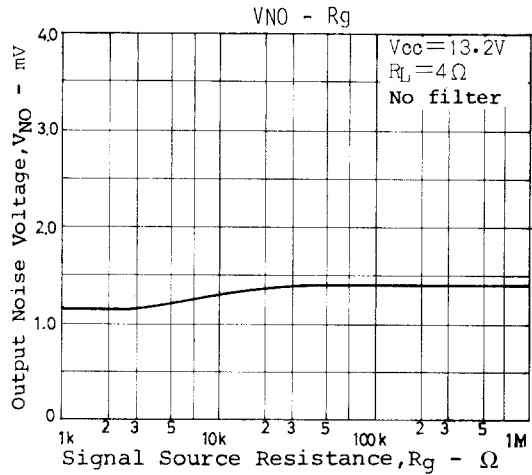
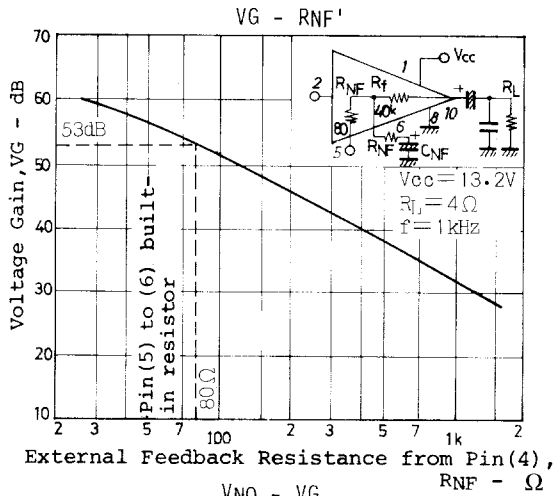
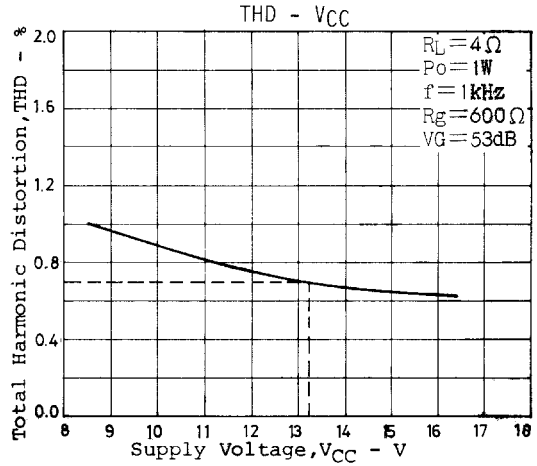
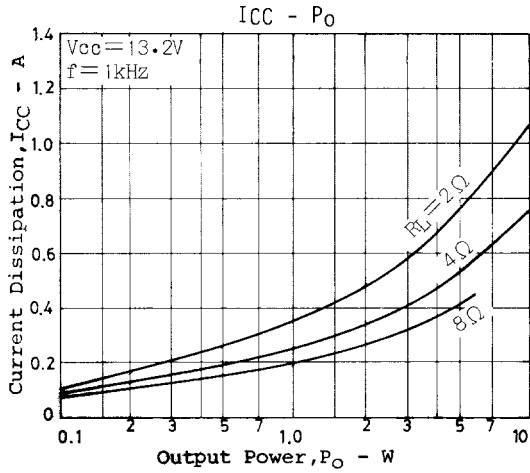

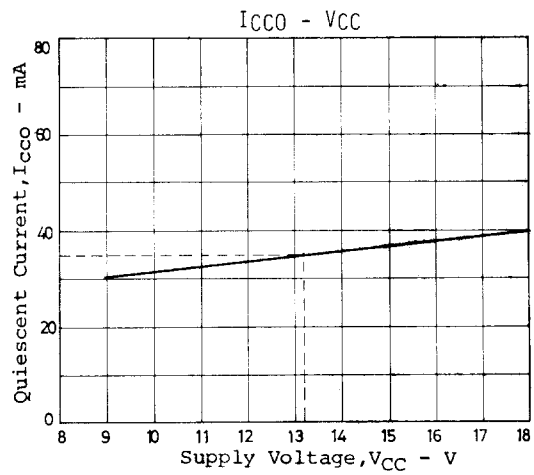
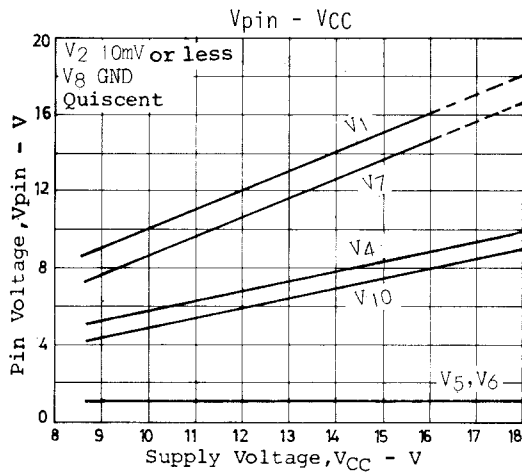
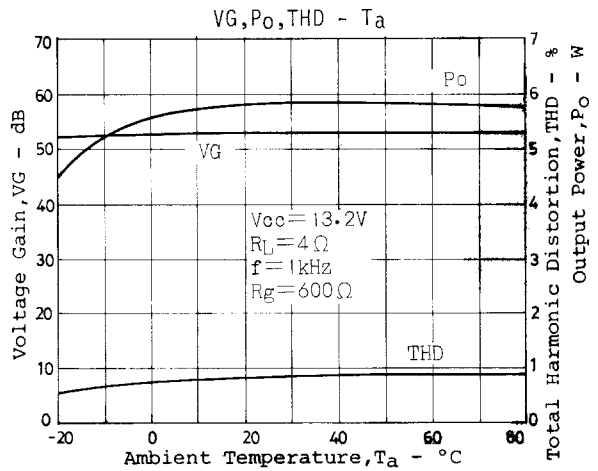
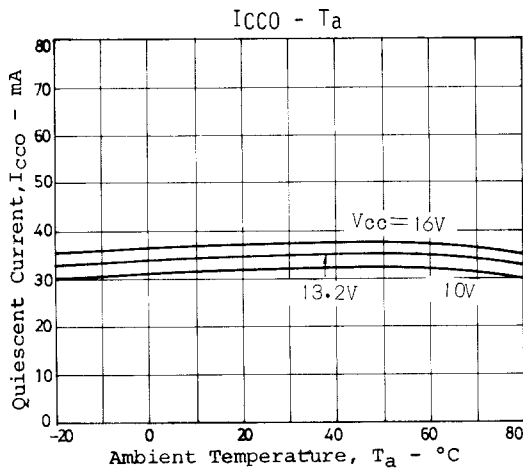
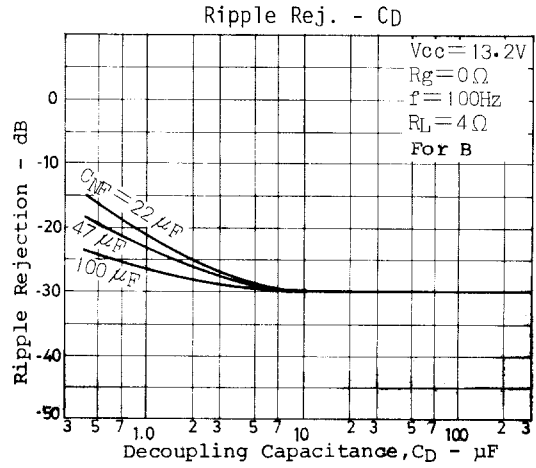
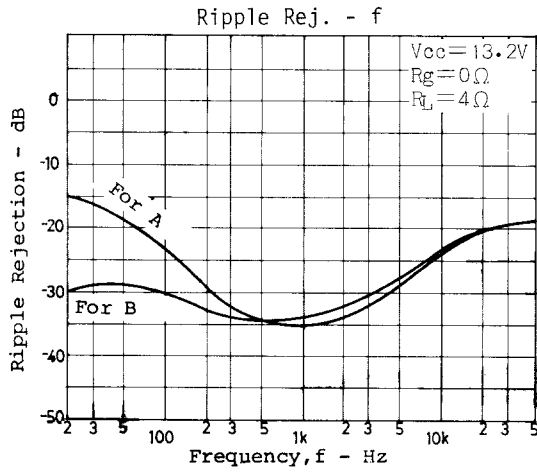

Output wave form (pop noise) influenced by C_D/V_{CC}=13.2V, R_L=4Ω, f=1kHz, V_O=1V

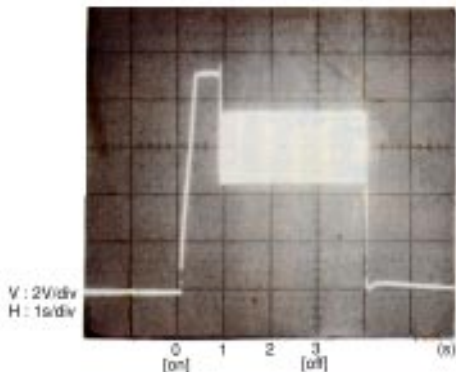

(1) C_{NF}=100μF, perfect discharge

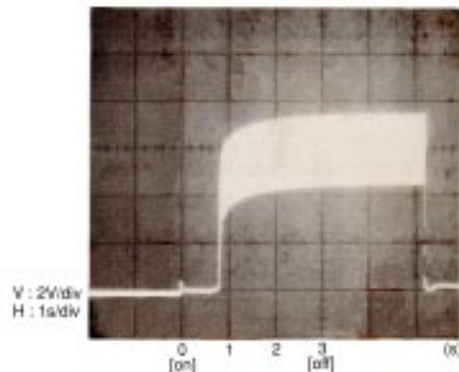

(2) C_{NF}=100μF, C_D=100μF

LA4422

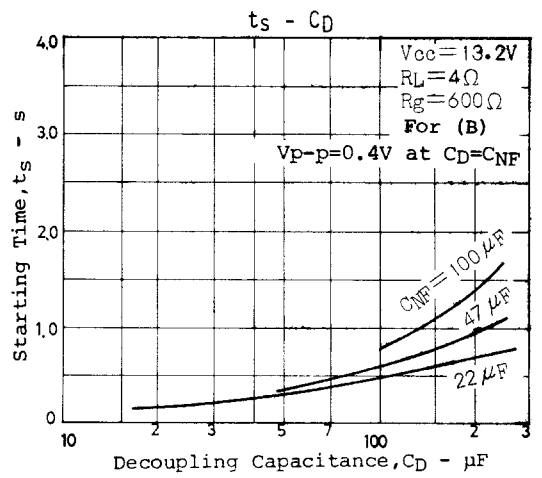
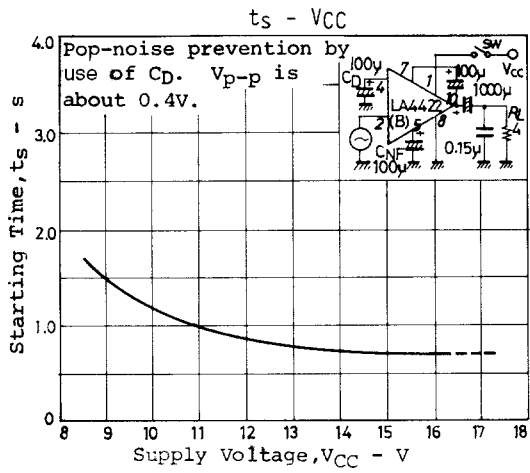
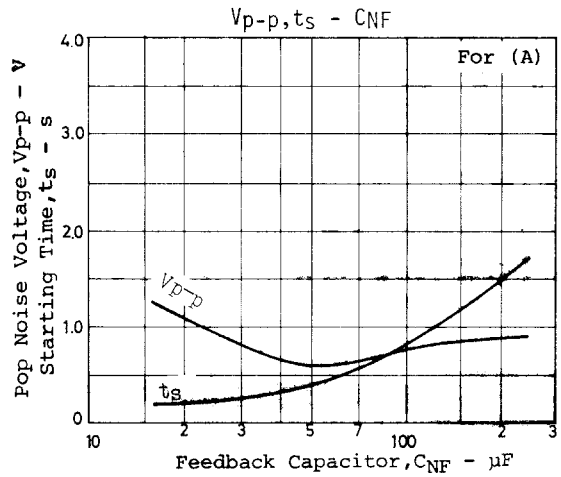
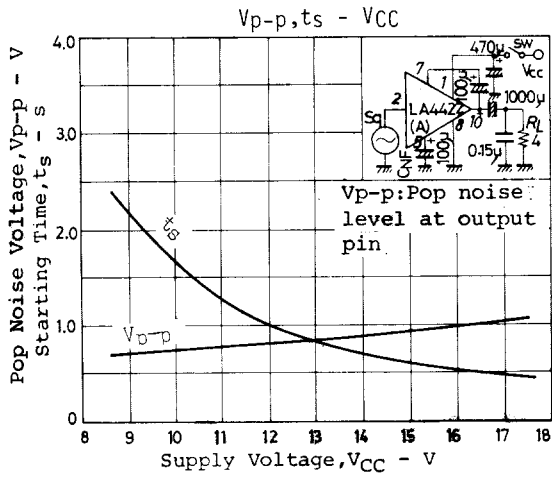

Sample Application Circuit 2. 18W typ. ($V_{CC}=13.2V$, $R_L=4\Omega$) BTL amplifier

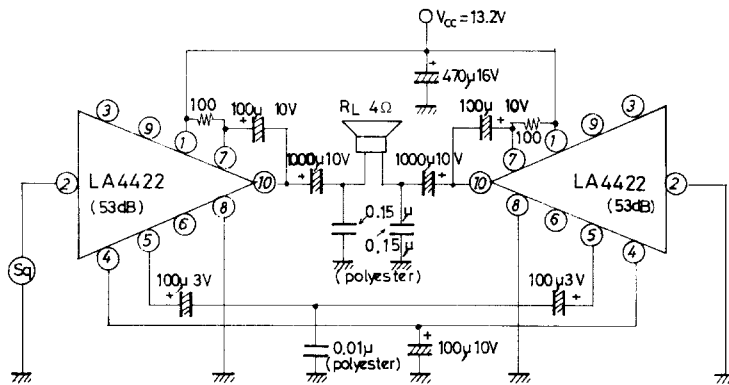

Unit (resistance: Ω , capacitance: F)

LA4422

The heat sink design of this circuit is so important that it is requested that you should consult us beforehand.

Unit (resistance: Ω , capacitance: F)

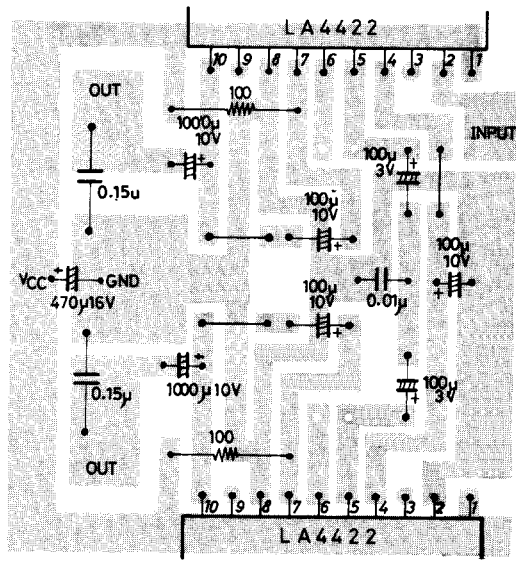

Sample Printed Circuit Pattern ($45 \times 43\text{mm}^3$, Cu-foiled side)

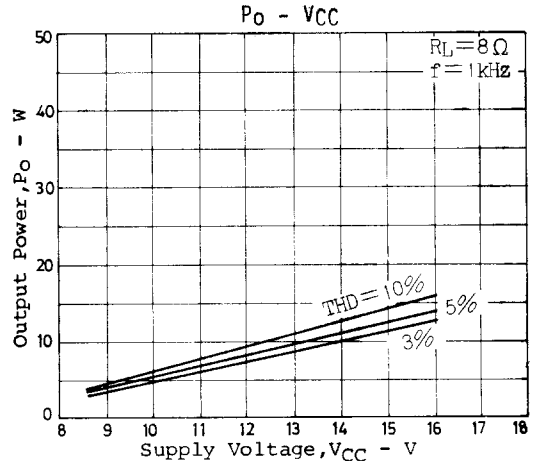
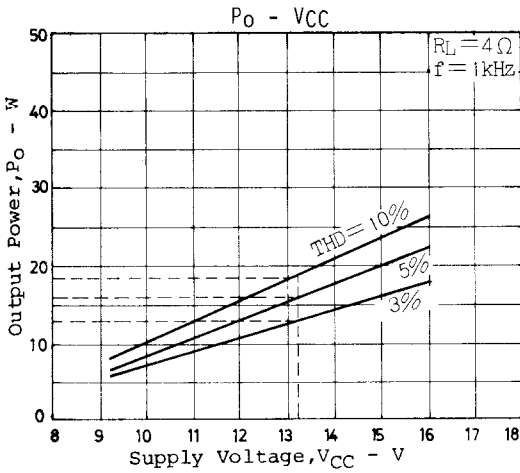

Sample Application Circuit 3. Pre-power amplifier for car stereo (4.75cm/s. cassette).

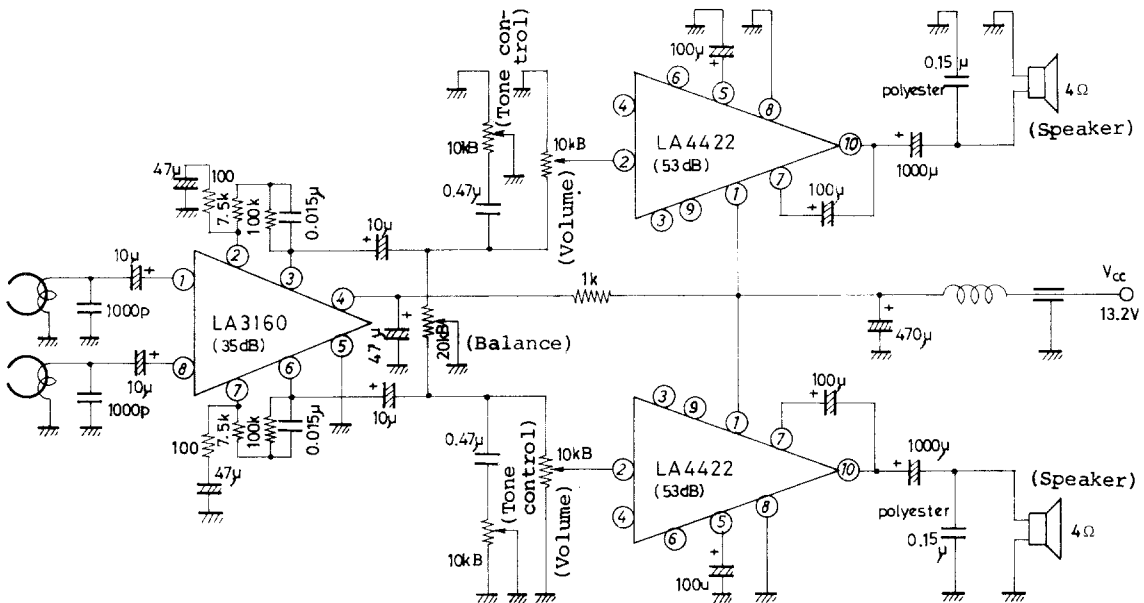

Unit (resistance: Ω , capacitance: F)

Proper Cares in Bridge Amplifier Application

For bridge amplifier design, take the following into consideration and consult our sales department.

- The LA4422 contains the thermal shutdown circuit which senses generation of abnormal heat attributable to load short, etc. and stops the internal circuit operation. Thus, breakdown attributable to generation of abnormal heat is prevented.
- This function operates normally for single IC operation, but the following extraordinary phenomena appear for bridge operation.
 - a) Generation of heat of non-inverting, inverting amplifier ICs at the time of output non-clip depends on the radiation condition of each IC.
 - b) Generation of heat at the time of output clip is always larger for inverting amplifier IC, which cannot be compensated even if there is slight difference of radiation condition between two ICs. This is because the output of non-inverter amplifier IC is clipped and enters completely into the saturation region and Pd (power dissipation) is reduced, while the output clip of inverting amplifier IC is a mere amplification of output (clip waveform) of non-inverter amplifier and does not enter into the saturation region and Pd (power dissipation) is held somewhere at the max. level.
 - c) For this reason, the inverting amplifier IC always generates more heat at the time of output clip. If the radiation condition is not designed correctly, the thermal shutdown circuit of inverting amplifier starts operating earlier.
 - d) For single IC operation, as above-mentioned, when the thermal shutdown circuit operates, not only the output signal but also Pd (power dissipation) is reduced so as to minimize generation of heat.

For bridge operation also, if the thermal shutdown circuit of non-inverting amplifier IC operates earlier than the inverting amplifier IC, generation of heat is minimized similarly to the single IC operation. This is because reduction of output of input side amplifier (inverting IC) causes reduction of the total output. (It is almost impossible to realize this state with the normal radiation design.) To the contrary, if the thermal shutdown circuit of inverting amplifier IC operates earlier, the output of this inverting amplifier IC is reduced, but Pd (power dissipation) is not reduced due to the drive from the output pin because of bridge connection and operation outside the ASO (area of safety operation) may occur.

- e) Therefore, if the thermal shutdown circuit operates (inverting side) at the time of bridge operation, the above phenomena occur, and if the applied voltage is high, breakdown of the IC beyond the ASO (area of safety operation) may result.
- f) As seen from the above, it is one of the most important factors in the bridge operation circuit design that the radiation design should be made to prevent the thermal circuit from operating.

- Specifications of any and all SANYO products described or contained herein stipulate the performance, characteristics, and functions of the described products in the independent state, and are not guarantees of the performance, characteristics, and functions of the described products as mounted in the customer's products or equipment. To verify symptoms and states that cannot be evaluated in an independent device, the customer should always evaluate and test devices mounted in the customer's products or equipment.
- SANYO Electric Co., Ltd. strives to supply high-quality high-reliability products. However, any and all semiconductor products fail with some probability. It is possible that these probabilistic failures could give rise to accidents or events that could endanger human lives, that could give rise to smoke or fire, or that could cause damage to other property. When designing equipment, adopt safety measures so that these kinds of accidents or events cannot occur. Such measures include but are not limited to protective circuits and error prevention circuits for safe design, redundant design, and structural design.
- In the event that any or all SANYO products (including technical data, services) described or contained herein are controlled under any of applicable local export control laws and regulations, such products must not be exported without obtaining the export license from the authorities concerned in accordance with the above law.
- No part of this publication may be reproduced or transmitted in any form or by any means, electronic or mechanical, including photocopying and recording, or any information storage or retrieval system, or otherwise, without the prior written permission of SANYO Electric Co., Ltd.
- Any and all information described or contained herein are subject to change without notice due to product/technology improvement, etc. When designing equipment, refer to the "Delivery Specification" for the SANYO product that you intend to use.
- Information (including circuit diagrams and circuit parameters) herein is for example only; it is not guaranteed for volume production. SANYO believes information herein is accurate and reliable, but no guarantees are made or implied regarding its use or any infringements of intellectual property rights or other rights of third parties.

This catalog provides information as of February, 2000. Specifications and information herein are subject to change without notice.