

SANYO

No. 3679

LA4583M**Compact Cassette Stereo Recording
and Playback System****OVERVIEW**

The LA4583M is a complete recording and playback system for compact cassette units. It incorporates microphone and tuner preamplifiers, and power amplifiers for both a low-impedance speaker and headphones. Mode switching is completely electronic, which greatly reduces switching noise.

The LA4583M features ALC circuitry to ensure optimum recording levels and on-chip supplies for external electret condenser microphones and bias oscillators.

The LA4583M operates from a 3 V supply and is available in 44-pin QIPs.

FEATURES

- Electronically switched recording and playback modes
- Automatic power and recording mute when switching modes
- 16 Ω stereo headphone amplifier
- 4 Ω mono speaker amplifier
- Automatic level control in recording mode
- Preamplifiers for external microphones and tuner circuits
- 3 V supply
- 44-pin QIP

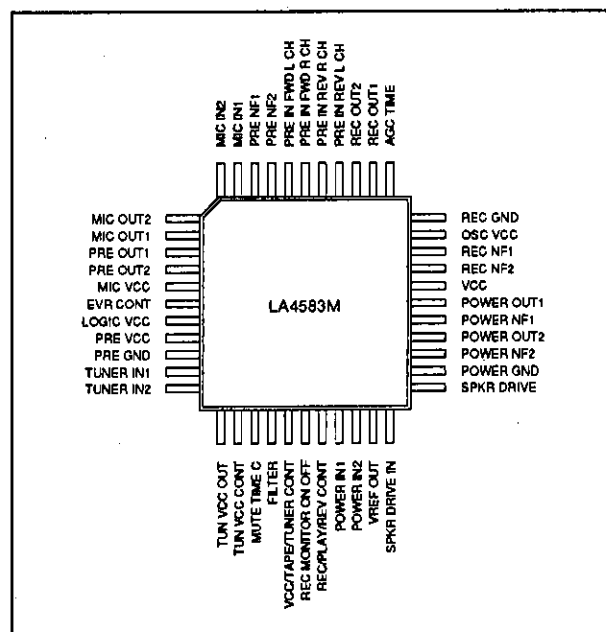
Pin Assignment**PACKAGE DIMENSIONS**

Unit: mm

3148-QIP44MA

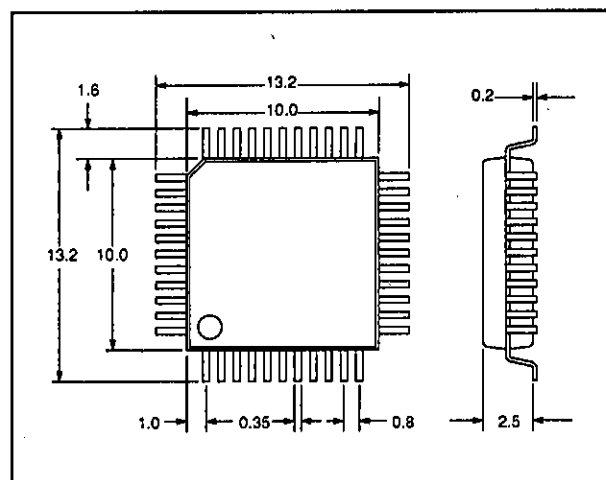

BLOCK DIAGRAM

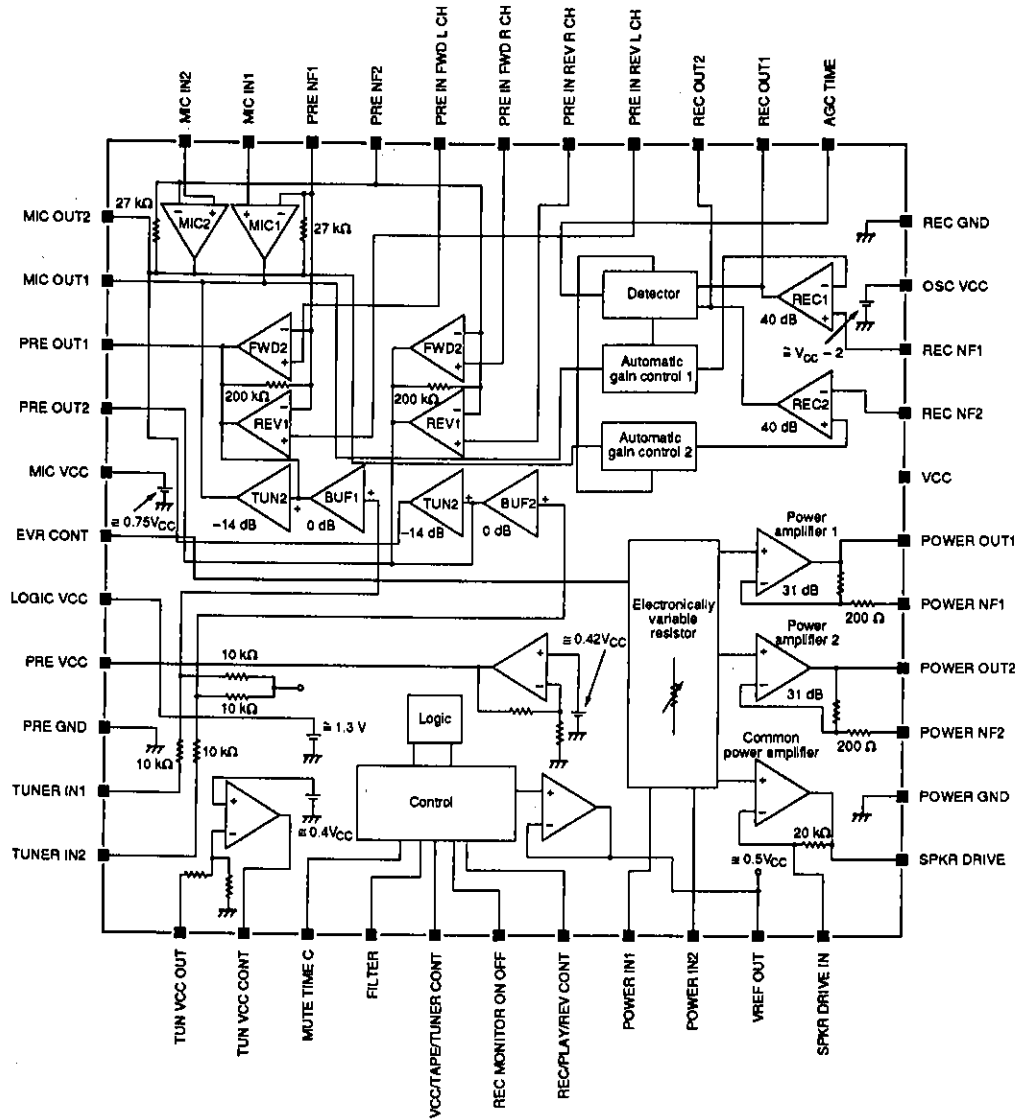

PIN DESCRIPTION

Number	Name	Equivalent circuit	Description
1	TUN VCC OUT		Tuner supply output. Output impedance is 20 kΩ. Nominal voltage is 2.5 V.
2	TUN VCC CONT		Tuner supply control output. Output impedance is 51 kΩ. Nominal voltage is 2.4 V.

LA4583M

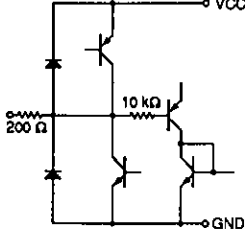
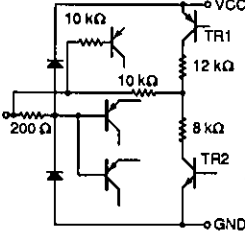
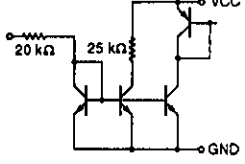
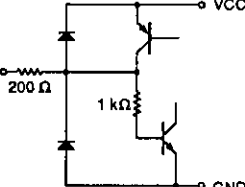
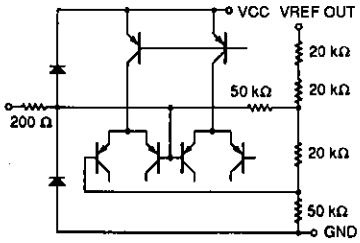
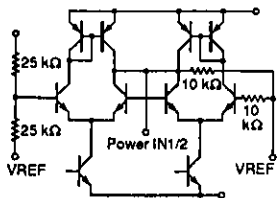
Number	Name	Equivalent circuit	Description
3	MUTE TIME C		Mute time control input. Nominal voltage range is 0.2 to 0.85 V.
4	FILTER		Voltage reference external filter capacitor. Nominal voltage is 1.2 V.
5	VCC/TAPE/TUNER CONT		Tape/tuner mode select input. Nominal voltage is 1.1 to 3.0 V.
6	REC MONITOR ON OFF		Recording monitor enable input. Input impedance is 110 k ohm. Nominal voltage is 0 to 0.7 V.
7	REC/PLAY/REV CONT		Recording/playback/reverse-playback mode select. Input impedance is 75 k ohm. Nominal voltage range is 0.1 to 1.5 V.
8	POWER IN1		Channel 1 headphone amplifier input. Input impedance is 50 k ohm. Nominal voltage is 1.5 V.
9	POWER IN2		Channel 2 headphone amplifier input. Input impedance is 50 k ohm. Nominal voltage is 1.5 V.

LA4583M

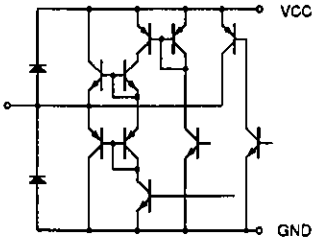
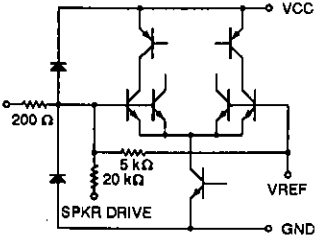
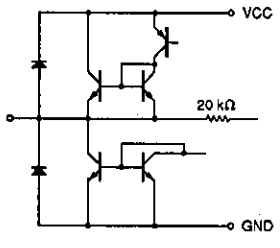
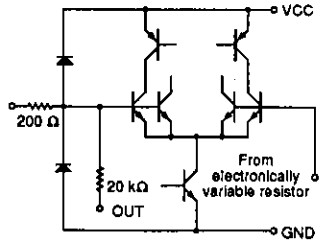
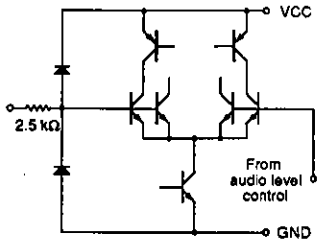
Number	Name	Equivalent circuit	Description
10	VREF OUT		Voltage reference output. Nominal voltage is 1.5 V.
11	SPKR DRIVE IN		Common amplifier input. Input impedance is 5 kΩ. Nominal voltage is 1.5 V.
12	SPKR DRIVE		Common amplifier output. Nominal voltage is 1.5 V.
15	POWER OUT2		Channel 2 headphone amplifier output. Nominal voltage is 1.5 V.
17	POWER OUT1		Channel 1 headphone amplifier output. Nominal voltage is 1.5 V.
13	POWER GND		Power amplifier ground
14	POWER NF2		Channel 2 headphone amplifier negative feedback input. Nominal voltage is 1.5 V.
16	POWER NF1		Channel 1 headphone amplifier negative feedback input. Nominal voltage is 1.5 V.
18	VCC		5 V supply
19	REC NF2		Channel 2 recording preamplifier negative feedback input. Nominal voltage is 1.5 V.
20	REC NF1		Channel 1 recording preamplifier negative feedback input. Nominal voltage is 1.5 V.

LA4583M

Number	Name	Equivalent circuit	Description
21	OSC VCC		External bias oscillator supply. Output impedance is 20 kΩ. Nominal voltage is 0.8 V.
22	REC GND		Recording amplifier ground
23	AGC TIME		AGC response control input. Nominal voltage range is 0.35 to 0.75 V.
24	REC OUT1		Channel 1 recording amplifier output. Nominal voltage is 1.5 V.
25	REC OUT2		Channel 2 recording amplifier output. Nominal voltage is 1.5 V.
26	PRE IN REV LCH		Left-channel reverse playback preamplifier input. Nominal voltage is 1.5 V.
27	PRE IN REV RCH		Right-channel reverse playback preamplifier input. Nominal voltage is 1.5 V.
28	PRE IN FWD RCH		Left-channel normal playback preamplifier input. Nominal voltage is 1.5 V.
29	PRE IN FWD LCH		Right-channel normal playback preamplifier input. Nominal voltage is 1.5 V.
30	PRE NF2		Channel 2 preamplifier negative feedback input. Nominal voltage is 1.5 V.
31	PRE NF1		Channel 1 preamplifier negative feedback input. Nominal voltage is 1.5 V.

LA4583M

Number	Name	Equivalent circuit	Description
32	MIC IN1		Channel 1 microphone preamplifier input. Input impedance is 5 kΩ. Nominal voltage is 1.5 V.
33	MIC IN2		Channel 2 microphone preamplifier input. Input impedance is 5 kΩ. Nominal voltage is 1.5 V.
34	MIC OUT2		Channel 2 microphone preamplifier output. Nominal voltage is 1.5 V.
35	MIC OUT1		Channel 1 microphone preamplifier output. Nominal voltage is 1.5 V.
36	PRE OUT1		Channel 1 playback preamplifier output. Nominal voltage is 1.5 V.
37	PRE OUT2		Channel 2 playback preamplifier output. Nominal voltage is 1.5 V.
38	MIC VCC		External microphone supply. Output impedance is 18 kΩ. Nominal voltage is 2.3 V.
39	EVR CONT		Electronic variable resistor (EVR) control voltage input. Input impedance is 16 kΩ. Nominal voltage is 0 to 1.3 V.
40	LOGIC VCC		Bias supply for internal logic circuits. Nominal voltage is 1.3 V.

LA4583M

Number	Name	Equivalent circuit	Description
41	PRE VCC		Bias supply for preamplifiers. Output impedance is 9.5 kΩ. Nominal voltage is 2.5 V.
42	PRE GND		Ground
43	TUNER IN1		Channel 1 tuner preamplifier input. Input impedance is 20 kΩ. Nominal voltage is 1.5 V.
44	TUNER IN2		Channel 2 tuner preamplifier input. Input impedance is 20 kΩ. Nominal voltage is 1.5 V.

Note

Nominal voltages measured with $V_{CC} = 3\text{ V}$.

SPECIFICATIONS

Absolute Maximum Ratings

Parameter	Symbol	Rating	Unit
Supply voltage	V_{CC}	4.5	V
Power dissipation	P_D	1	W
Operating temperature range	T_{opr}	-20 to 75	°C
Storage temperature range	T_{stg}	-40 to 125	°C

Recommended Operating Conditions

$T_a = 25\text{ °C}$

Parameter	Symbol	Rating	Unit
Supply voltage	V_{CC}	3	V
Supply voltage range	V_{CC}	1.8 to 3.6	V

Electrical Characteristics

$V_{CC} = 3\text{ V}$, $T_a = 25\text{ °C}$, 0 dB = 1 V, $f = 1\text{ kHz}$, $R_L = 10\text{ k}\Omega$ (preamplifiers), $R_L = 16\text{ }\Omega$ (headphone amplifiers), $R_L = 4\text{ }\Omega$ (common amplifier)

Parameter	Symbol	Condition	Rating			Unit
			min	typ	max	
Quiescent supply current	I_{CCO}	Forward playback mode	14	22	40	mA
		Recording mode	14	28	45	

Playback preamplifiers

Parameter	Symbol	Condition	Rating			Unit
			min	typ	max	
Open-loop voltage gain	V_{GHO}		65	80	-	dB
Closed-loop voltage gain	V_{GH}		36	38	40	dB
Total harmonic distortion	THD_H	$V_0 = -5$ dBV	-	0.05	1.0	%
Input conversion noise	V_{NIH}	$R_0 = 2.2$ k Ω , DIN AUDIO filter	-	1	2	μ V
Maximum output voltage	V_{OH} max	THD = 5%	0.3	0.65	-	V

Tuner preamplifiers

Parameter	Symbol	Condition	Rating			Unit
			min	typ	max	
Closed-loop voltage gain	V_{GR}		-8	-6	-4	dB
Total harmonic distortion	THD_R	$V_0 = -15$ dBV	-	0.1	1.0	%
Maximum output voltage	V_{OR} max	THD = 5%	0.2	0.6	-	V
Output noise voltage	V_{NOR}	$R_0 = 10$ k Ω , DIN AUDIO filter	-	10	30	μ V

Microphone recording circuitry

Parameter	Symbol	Condition	Rating			Unit
			min	typ	max	
Closed-loop voltage gain	V_{GMR}		77	80	83	dB
Total harmonic distortion	THD_{MR}	$V_0 = 0.775$ V, $C_{35} = C_{36} = 1.8$ nF	-	0.7	1.5	%
Maximum output voltage	V_{OMR}	THD = 5%, AGC is OFF.	0.7	1.1	-	V
Output noise voltage	V_{NOMR}	$R_0 = 2.2$ k Ω , DIN AUDIO filter	-	15	30	mV
Channel balance	CB_{MR}		-2	0	2	dB
Interchannel crosstalk	CT_{MR}	$R_0 = 2.2$ k Ω , 1 kHz TUNE filter	16	25	-	dB

Tuner recording circuitry

Parameter	Symbol	Condition	Rating			Unit
			min	typ	max	
Closed-loop voltage gain	V_{GRR}	-10 dBV at tuner inputs	19	21	23	dB
Total harmonic distortion	THD_{RR}	$V_0 = -6$ dBV, EVR is OFF.	-	0.15	1.0	%
Output voltage	V_{ORR} max	THD = 5%	0.7	1.1	-	V
Channel balance	CB_{RR}		-2	0	2	dB
Interchannel crosstalk	CT_{RR}	$R_0 = 10$ k Ω , 1 kHz TUNE filter	30	50	-	dB

EVR and power amplifiers

Parameter	Symbol	Condition	Rating			Unit
			min	typ	max	
Closed-loop voltage gain	V_{GE}	EVR is at maximum resistance.	28	31	34	dB
Total harmonic distortion	THD_E	$P_O = 10$ mW	0.1	0.5	1.0	%
Maximum output power	$P_{O\ max}$	THD = 10%	20	33	—	mW
Output noise voltage	V_{NORE}	EVR is OFF. DIN AUDIO filter	—	170	500	μ V
Maximum EVR attenuation	α_{ATT}	EVR is OFF. 1 kHz TUNE filter	50	70	—	dB
EVR input impedance	R_{IEV}		35	50	65	k Ω

Preamplifiers and power amplifiers

Parameter	Symbol	Condition	Rating			Unit
			min	typ	max	
Channel balance	CB_T		-2	0	2	dB
Interchannel crosstalk	CT_T	$R_G = 2.2$ k Ω , 1 kHz TUNE filter	30	38	—	dB
Crosstalk between forward and reverse playback preamplifiers	CT_{HH}	1 kHz TUNE filter	30	65	—	dB
Crosstalk between playback and tuner inputs	CT_{HR}	1 kHz TUNE filter	50	70	—	dB
Crosstalk between recording amplifier outputs and microphone inputs	CT_{MRH}	Recording mode, 1 kHz TUNE filter	50	70	—	dB

Automatic gain control

Parameter	Symbol	Condition	Rating			Unit
			min	typ	max	
AGC response	AGC_W	From activation to 5% THD at RECOUT	35	42	—	dB
Channel balance	AGC_{GLC}		-2	0	2	dB
Minimum activation level	AGC_{INS}		-30	-27	-24	dBV

Common amplifier

Parameter	Symbol	Condition	Rating			Unit
			min	typ	max	
Closed-loop voltage gain	V_{GPWR}	$R_{XR} = 5$ k Ω	9	11	13	dB
Total harmonic distortion	THD_{PWR}	$P_O = 50$ mW	—	0.6	1.0	%
Output noise voltage	V_{NOPWR}	$R_{XR} = 5$ k Ω , DIN AUDIO filter	—	15	50	μ V
Maximum output power	P_{OPWR}	THD = 10%	75	120	—	mW
Microphone supply voltage	V_{MCC}	$I_L = 2$ mA	2.0	2.3	2.5	V

LA4583M

Parameter	Symbol	Condition	Rating			Unit
			min	typ	max	
Tuner supply voltage	V_{TCC}	$I_L = 30 \text{ mA}$, external transistor is 2SA1178.	2.0	2.5	2.7	V
Oscillator supply voltage	V_{OSCC}	$I_L = 15 \text{ mA}$	0.65	0.85	1.0	V

Measurement Circuit

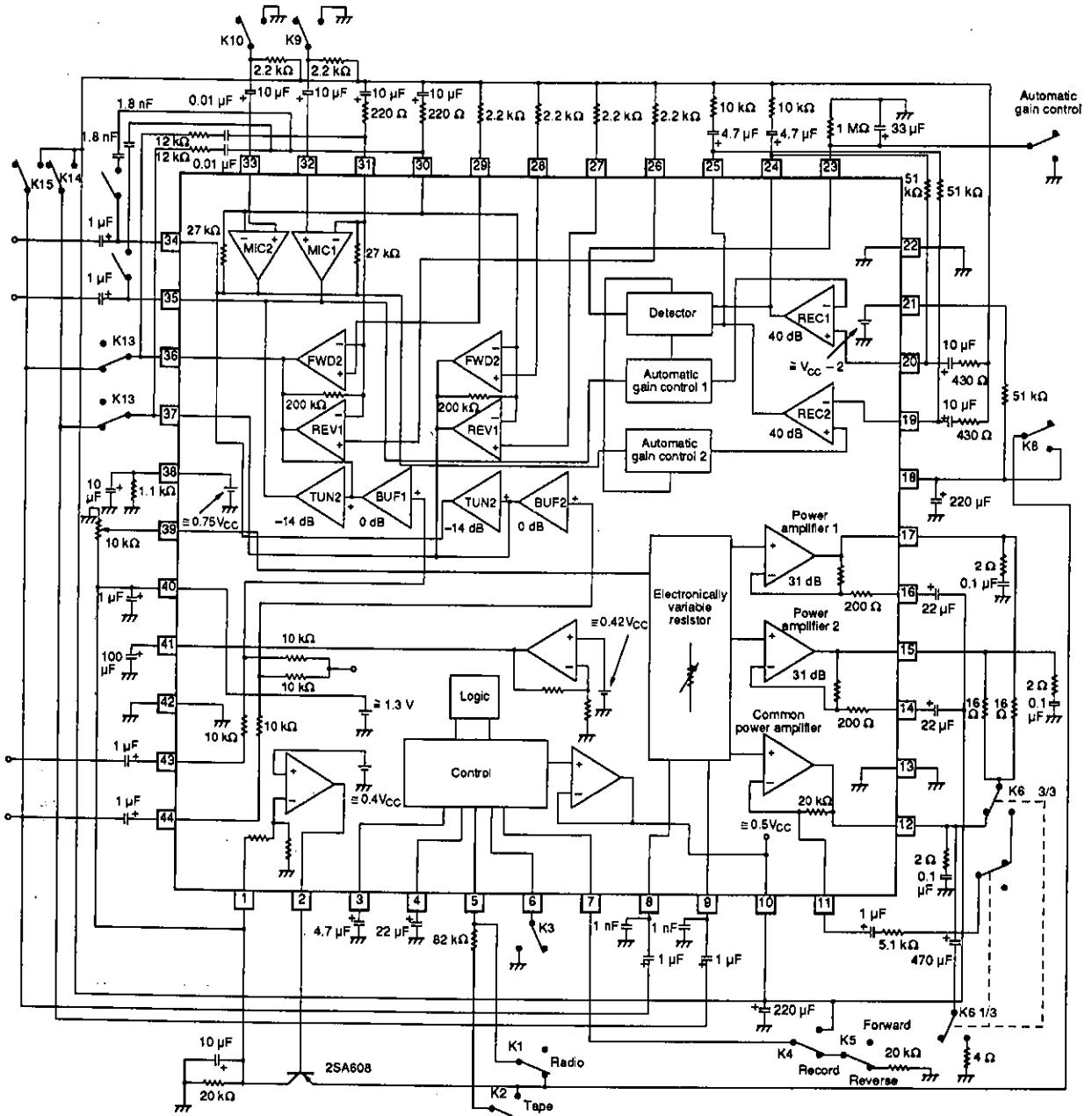

Typical Performance Characteristics

Power dissipation vs. ambient temperature

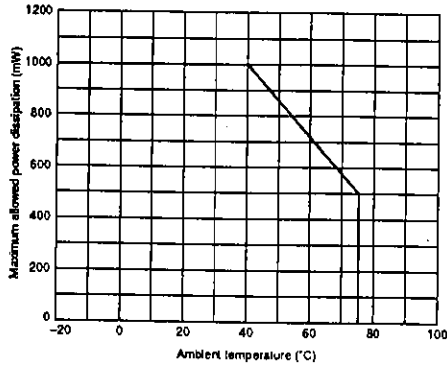

Quiescent current vs. ambient temperature

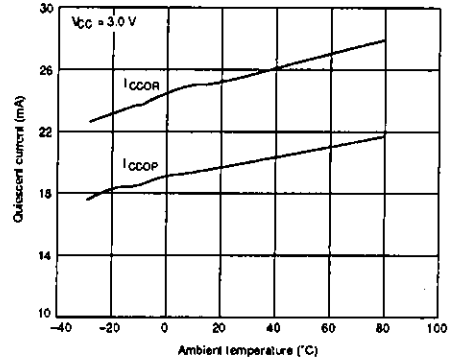

Quiescent current vs. supply voltage

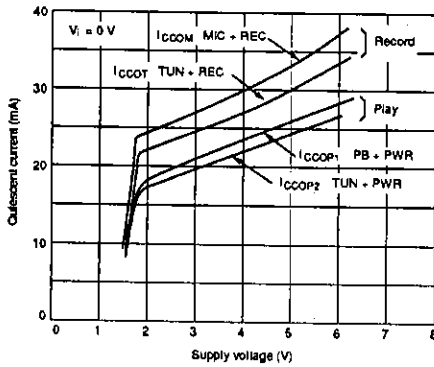

Playback preamplifiers

Closed-loop and open-loop gain vs. frequency

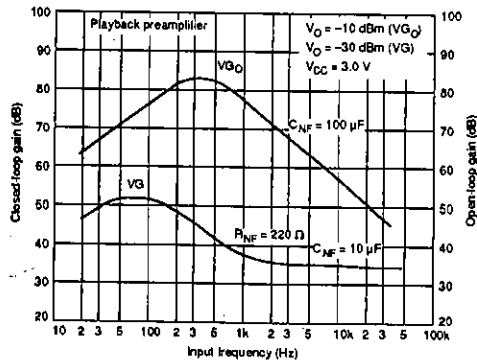

Closed-loop gain vs. supply voltage

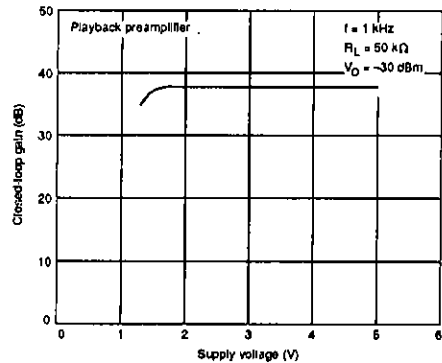

Closed-loop gain vs. frequency

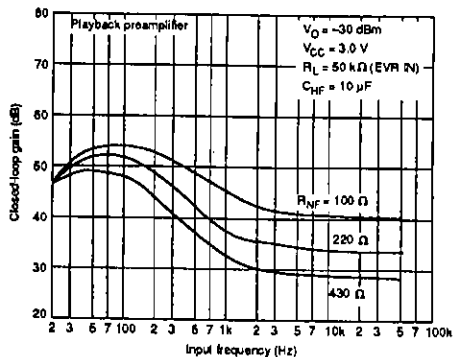

Total harmonic distortion and output voltage vs. Input voltage (1)

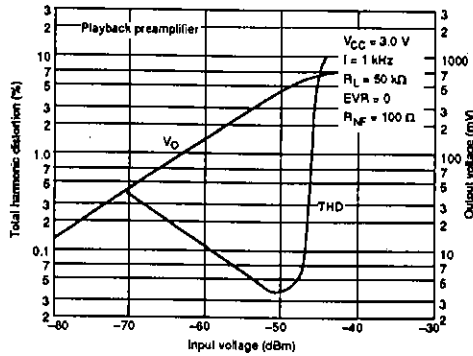

Output noise voltage vs. source resistance

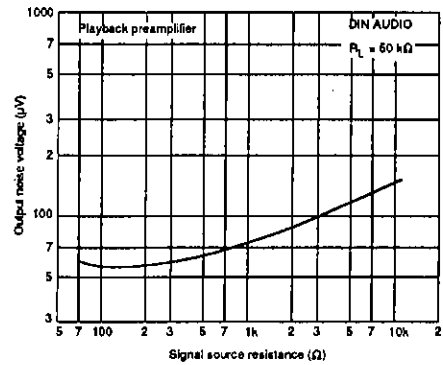

Total harmonic distortion and output voltage vs. Input voltage (2)

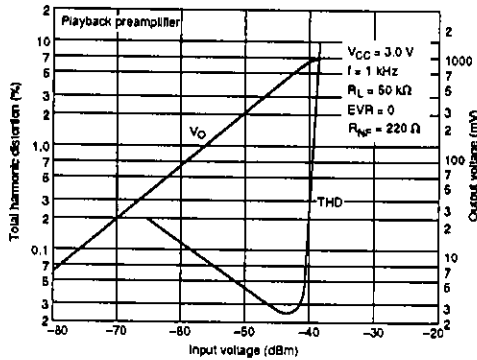

Output noise voltage vs. supply voltage

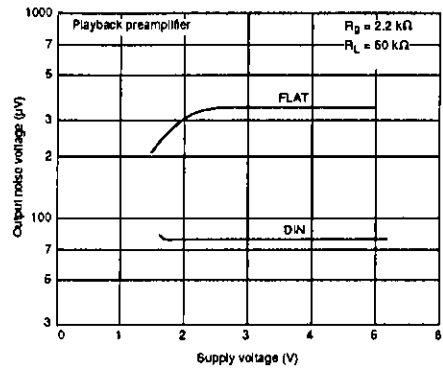

Maximum output voltage vs. supply voltage (1)

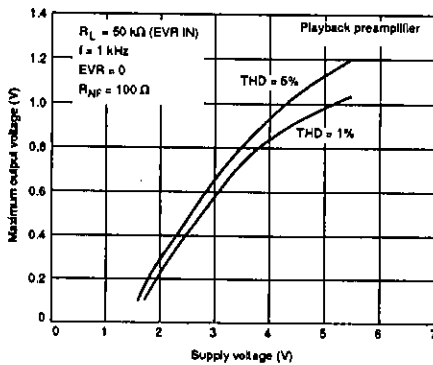

Output DC offset vs. ambient temperature (1)

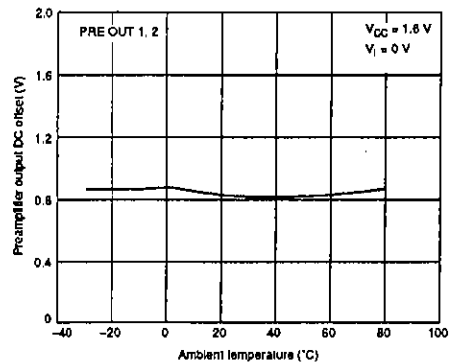

Maximum output voltage vs. supply voltage (2)

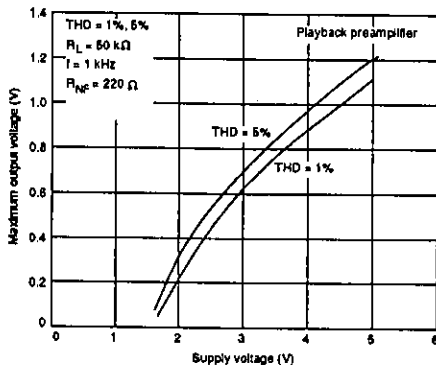

Output DC offset vs. ambient temperature (2)

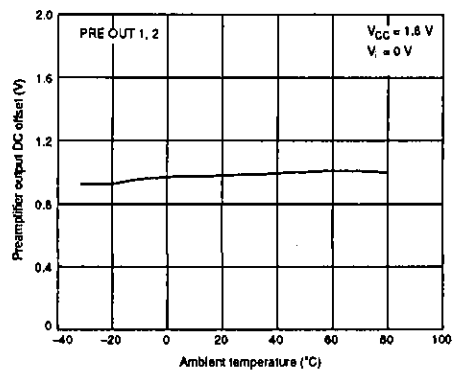

Output DC offset vs. ambient temperature (3)

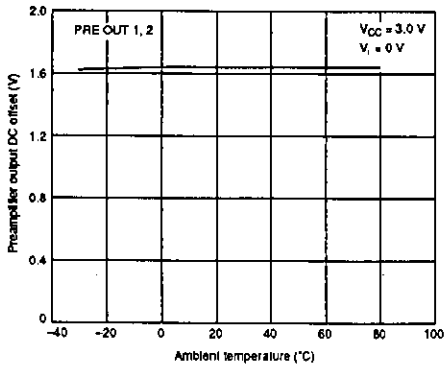

Output DC offset vs. ambient temperature (4)

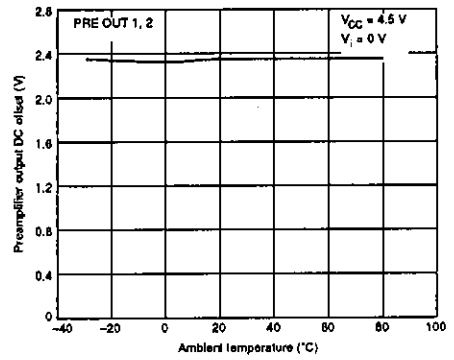

Preamplifiers, EVR and power amplifiers

Closed-loop gain vs. frequency

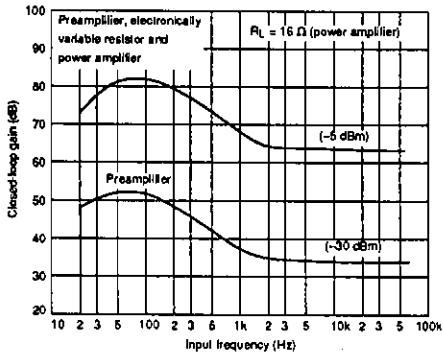

Crosstalk between forward and reverse channels vs. frequency

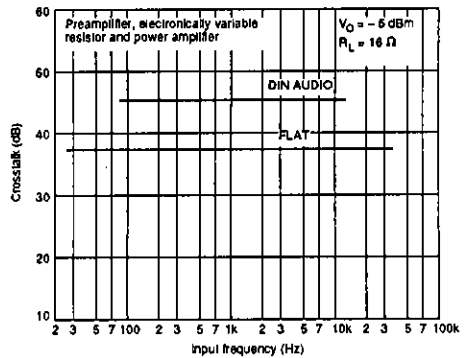

Total playback gain vs. ambient temperature

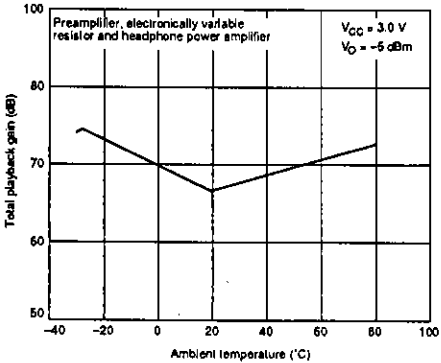

Crosstalk with tuner Inputs vs. frequency

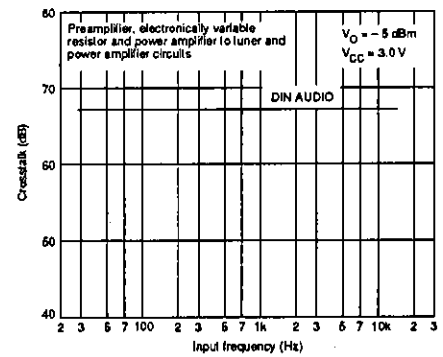

Crosstalk between channels vs. frequency

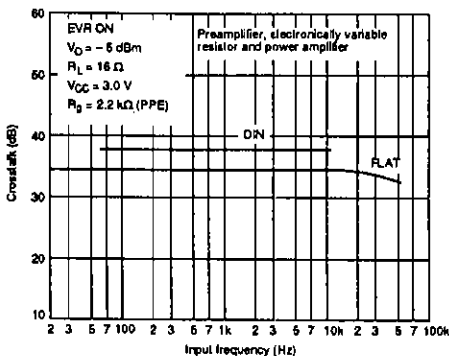

Crosstalk with microphone and recording amplifiers vs. frequency

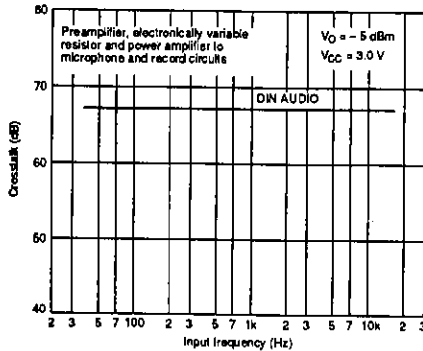

EVR attenuation vs. potentiometer rotation

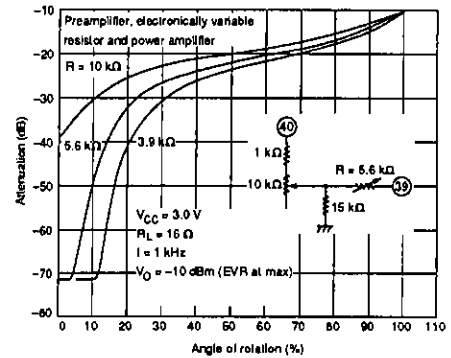

Tuner preamplifiers

Closed-loop gain vs. frequency

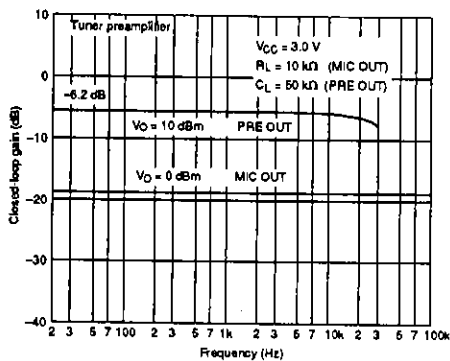

Playback and tuner preamplifiers

Total harmonic distortion and output voltage vs. Input voltage

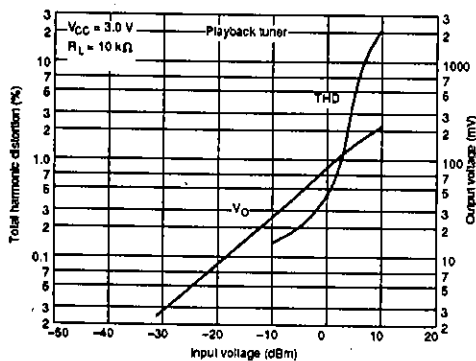

Maximum output voltage vs. supply voltage

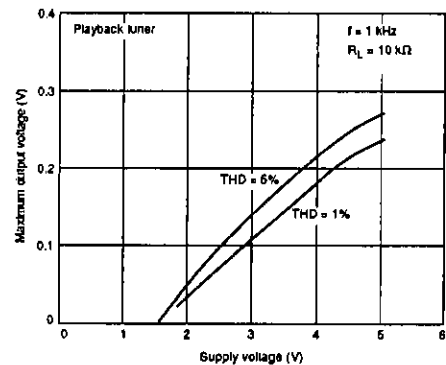

Crosstalk between channels vs. frequency (1)

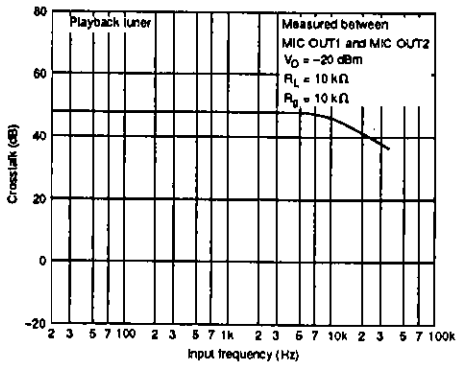

Output noise voltage vs. supply voltage (1)

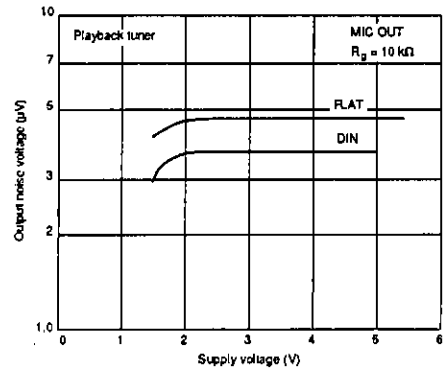

Crosstalk between channels vs. frequency (2)

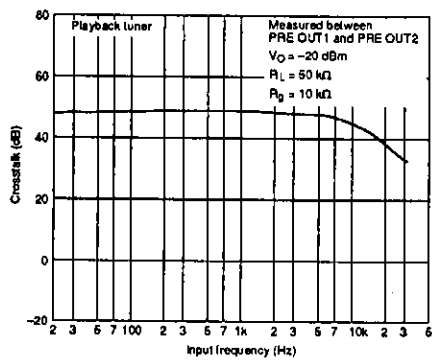

Output noise voltage vs. supply voltage (2)

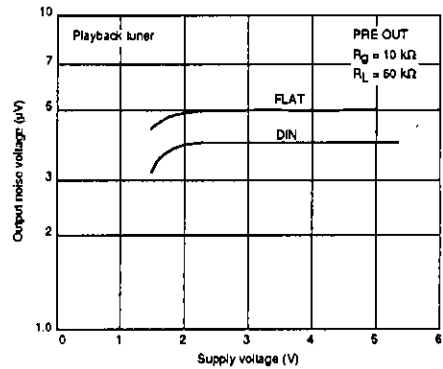

Common amplifier

Open-loop voltage gain vs. frequency

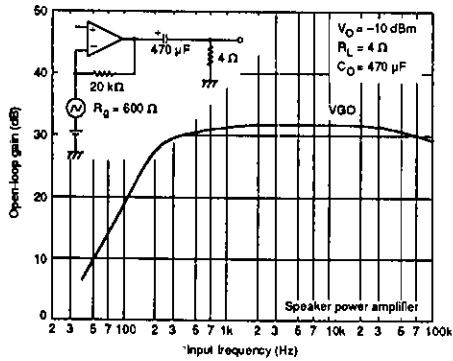

Closed-loop voltage gain vs. frequency (2)

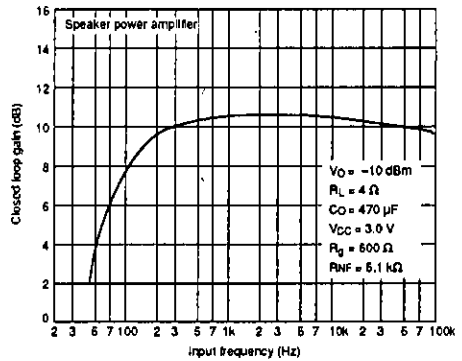

Closed-loop voltage gain vs. frequency (1)

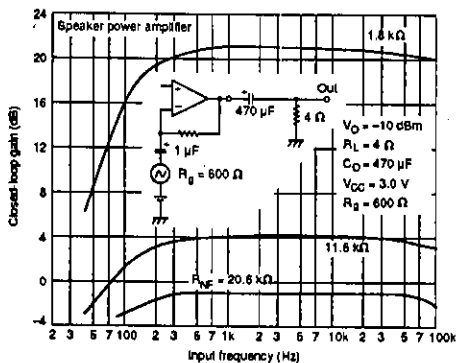

Closed-loop voltage gain vs. frequency (3)

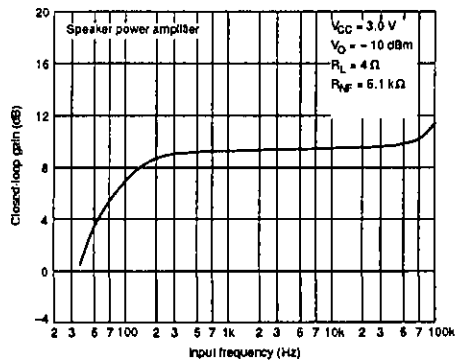

Total harmonic distortion vs. output power

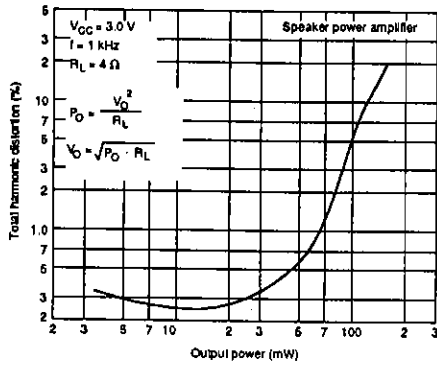

Output impedance vs. frequency

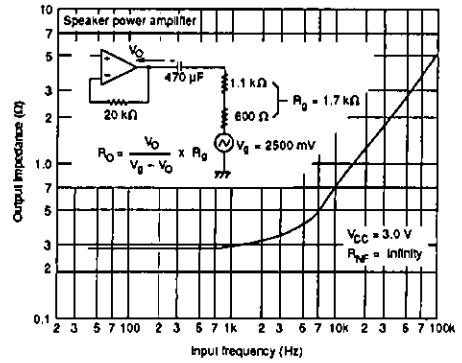

Output noise voltage vs. supply voltage (1)

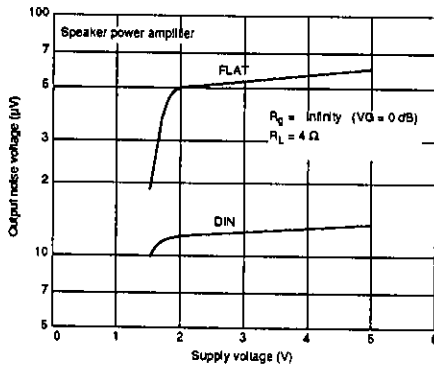

Output power vs. Input voltage

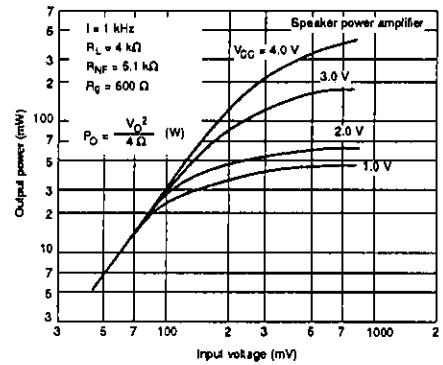

Output noise voltage vs. supply voltage (2)

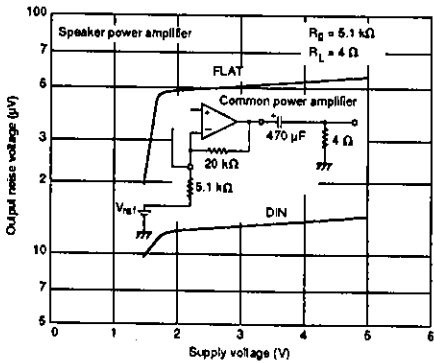

Maximum output power vs. supply voltage

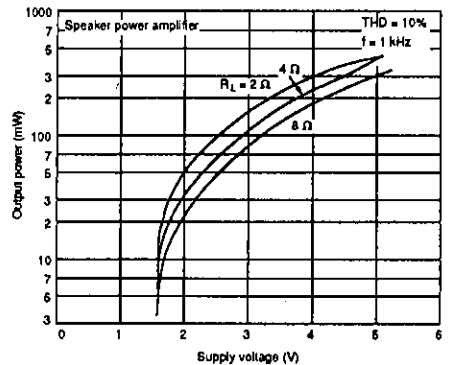

Output impedance vs. negative feedback resistance

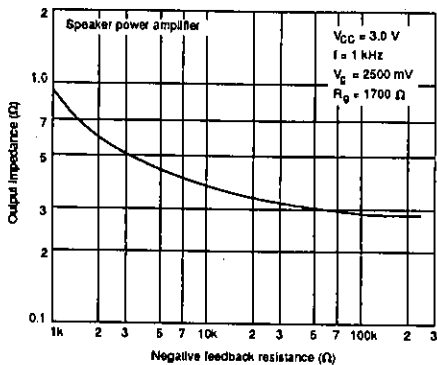

Headphone amplifiers

Closed-loop voltage gain vs. frequency (1)

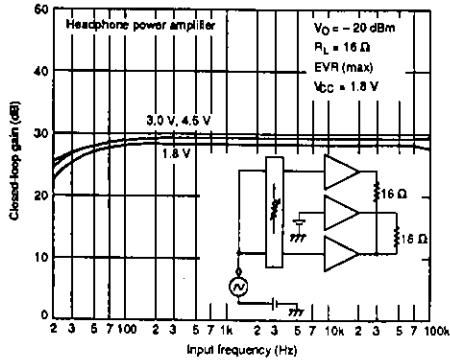

Total harmonic distortion vs. output power (2)

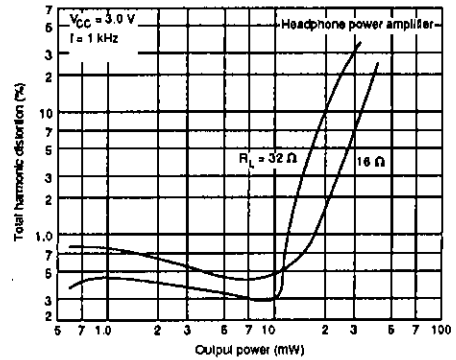

Closed-loop voltage gain vs. frequency (2)

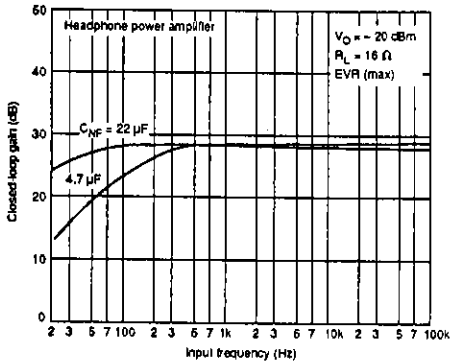

Total harmonic distortion and output voltage vs. input voltage (1)

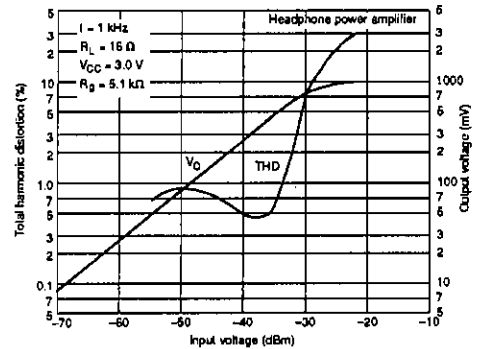

Closed-loop voltage gain vs. frequency (3)

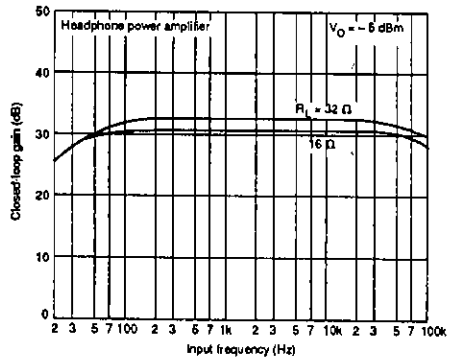

Total harmonic distortion and output voltage vs. input voltage (2)

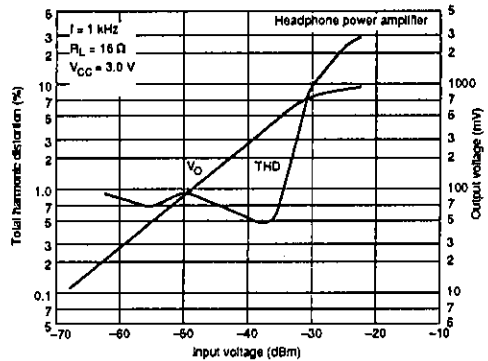

Total harmonic distortion vs. output power (1)

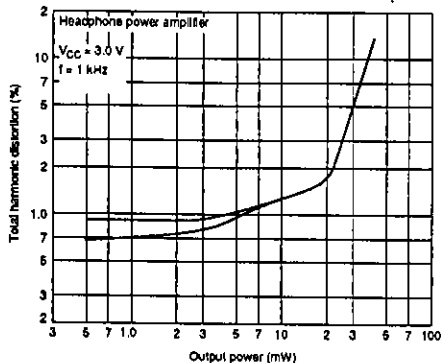

Total harmonic distortion and output voltage vs. Input voltage (3)

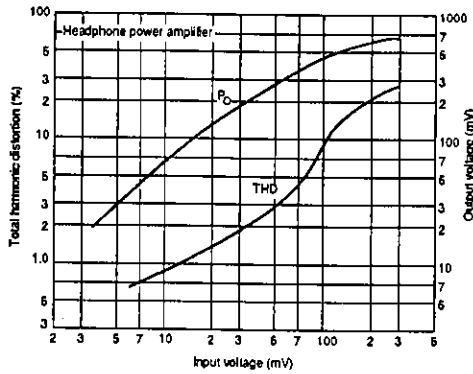

Crosstalk between channels vs. frequency

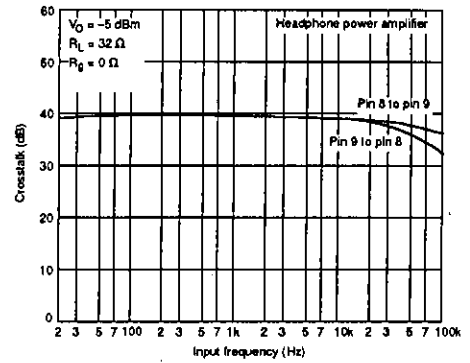

Total harmonic distortion and output voltage vs. Input voltage (4)

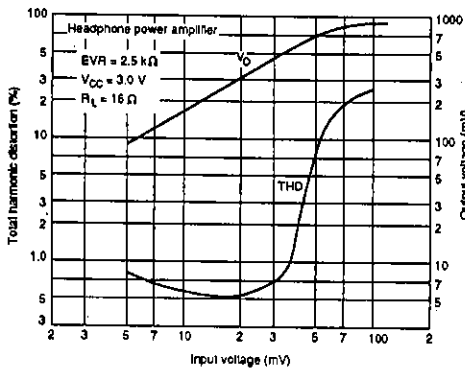

Output noise voltage vs. supply voltage

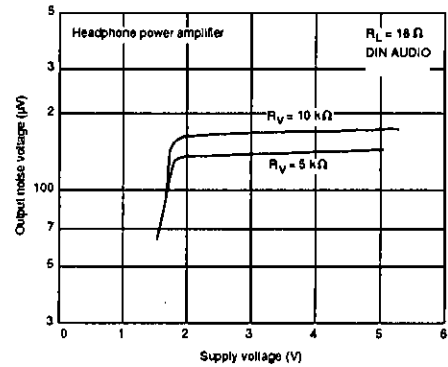

Maximum output voltage vs. ambient temperature

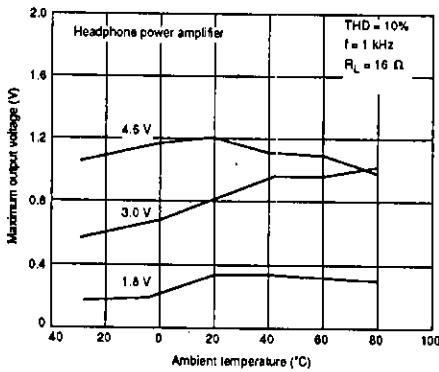

Output voltage vs. ambient temperature (1)

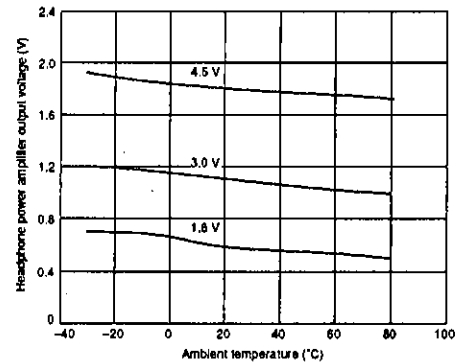

Output voltage vs. Input voltage

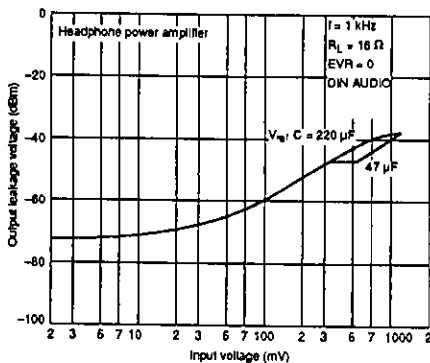

Output voltage vs. ambient temperature (2)

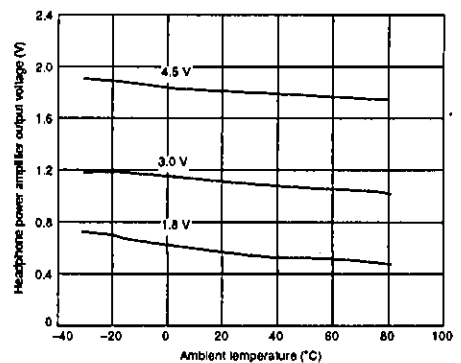

Output power vs. Input voltage

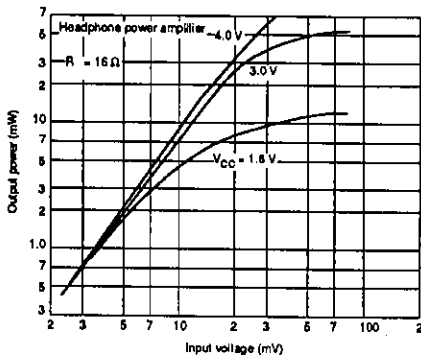

Output power vs. supply voltage

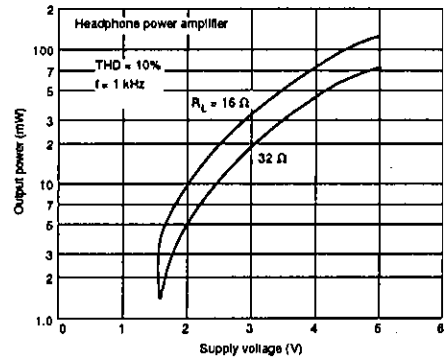

Headphone and common amplifier

DC offset between headphone outputs vs. ambient temperature (1)

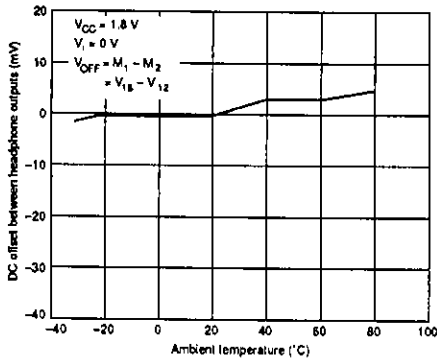

DC offset between headphone outputs vs. ambient temperature (3)

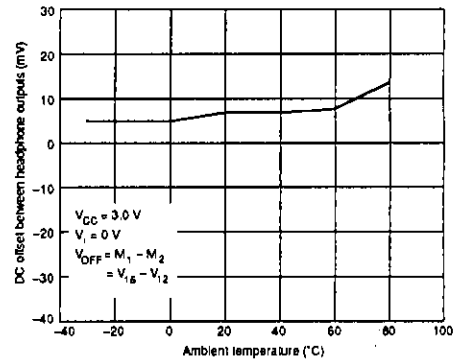

DC offset between headphone outputs vs. ambient temperature (2)

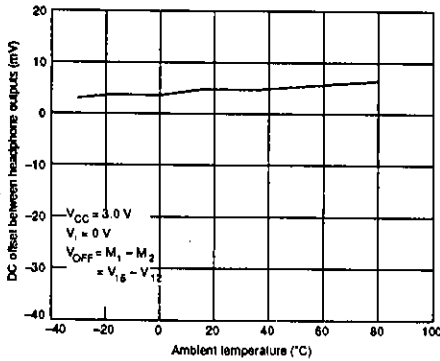

DC offset between headphone outputs vs. ambient temperature (4)

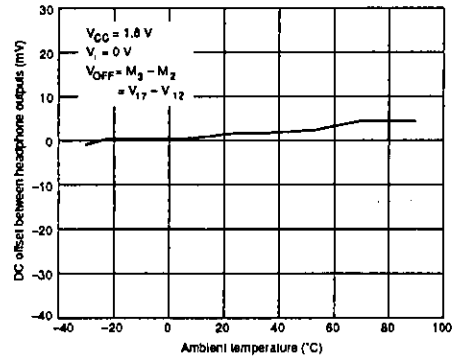

Amplifier DC offset vs. ambient temperature (1)

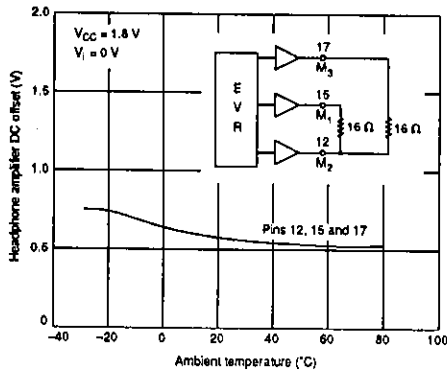

Amplifier DC offset vs. ambient temperature (5)

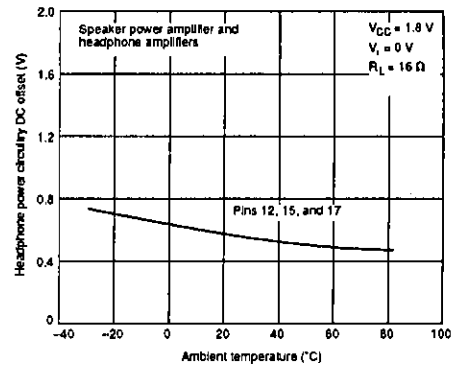

Amplifier DC offset vs. ambient temperature (2)

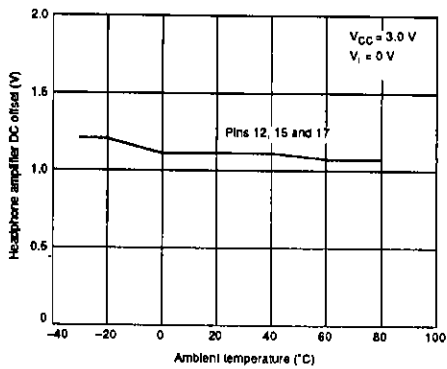

Amplifier DC offset vs. ambient temperature (6)

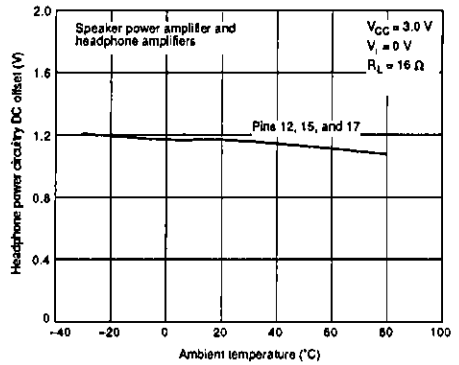

Amplifier DC offset vs. ambient temperature (3)

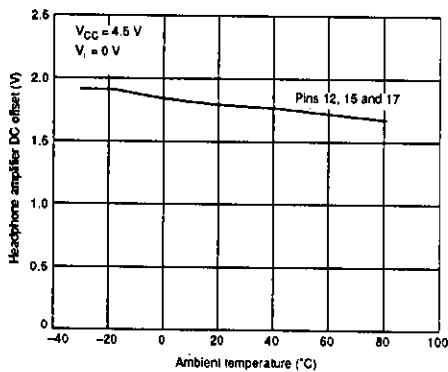

Amplifier DC offset vs. ambient temperature (7)

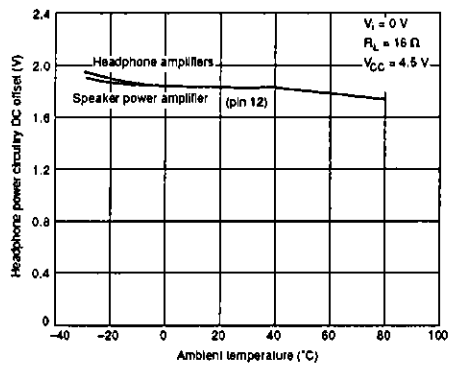

Amplifier DC offset vs. ambient temperature (4)

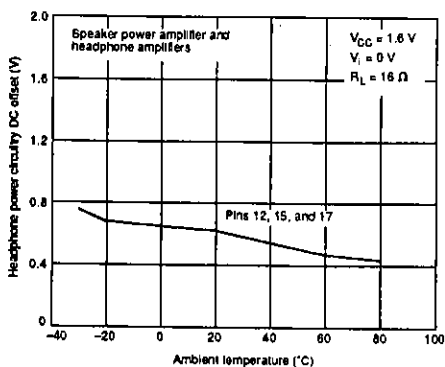

Amplifier DC offset vs. ambient temperature (8)

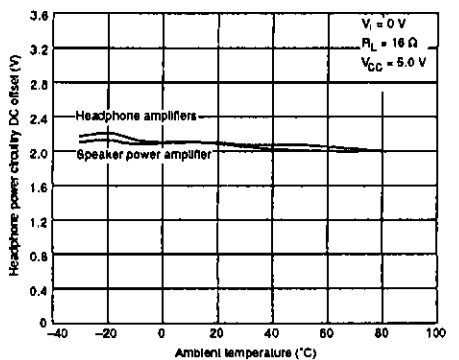

Playback amplifiers, EVR and power amplifiers

Crosstalk between forward and reverse channels vs. frequency

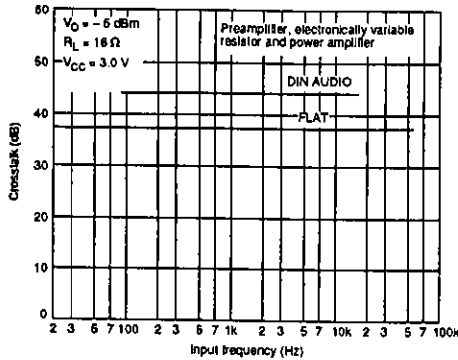

EVR and headphone amplifiers

Crosstalk between channels vs. frequency (1)

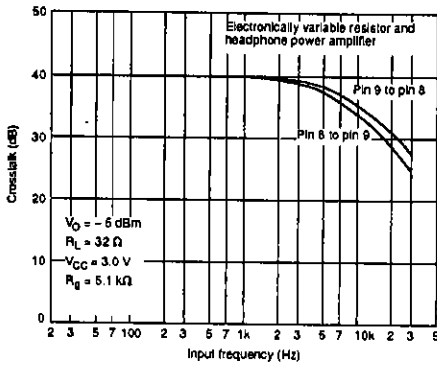

Crosstalk between channels vs. frequency (2)

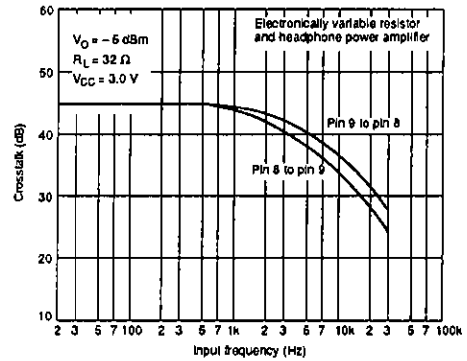

Microphone and recording amplifiers

Closed-loop gain vs. frequency

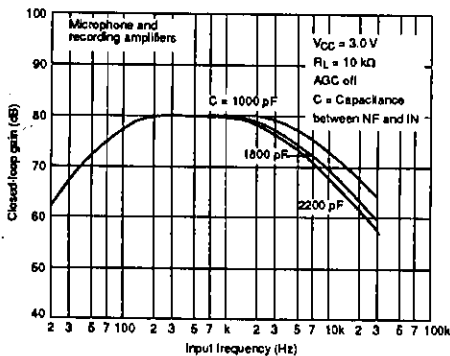

Total harmonic distortion and output voltage vs. input voltage (1)

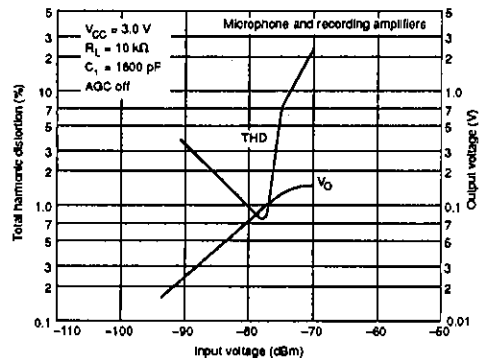

Total harmonic distortion and output voltage vs. Input voltage (2)

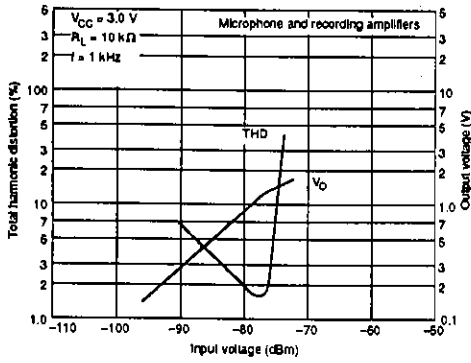

Crosstalk between channels vs. frequency

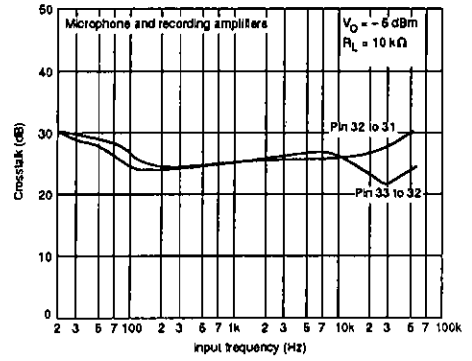

Maximum output voltage vs. supply voltage

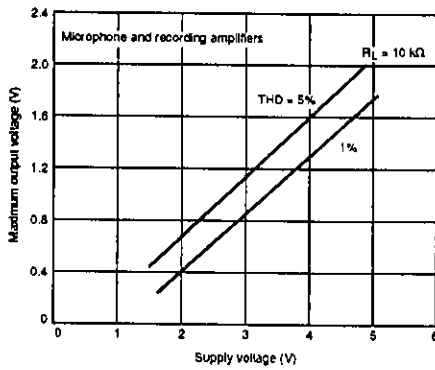

Output noise voltage vs. supply voltage (1)

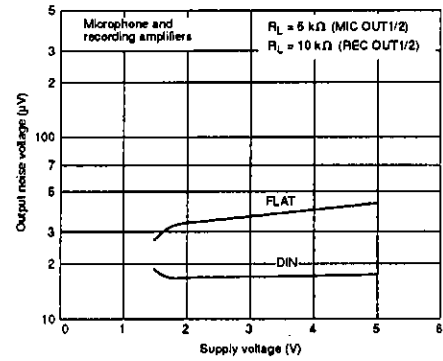

Crosstalk with tuner and recording amplifiers vs. frequency

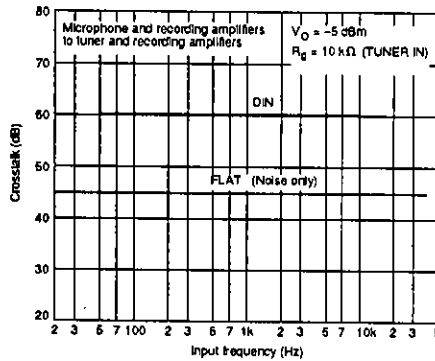

Output noise voltage vs. supply voltage (2)

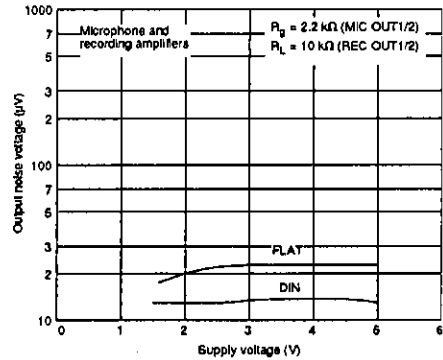

Microphone amplifiers, AGC and recording amplifiers

Total harmonic distortion and ALC output voltage vs. Input voltage (1)

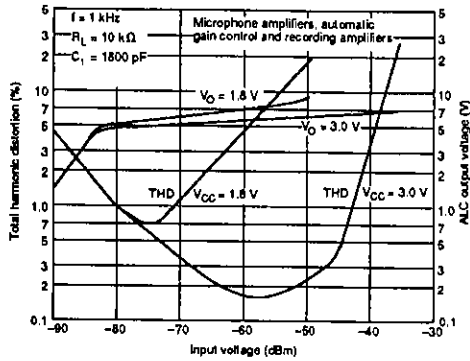

Total harmonic distortion and ALC output voltage vs. Input voltage (2)

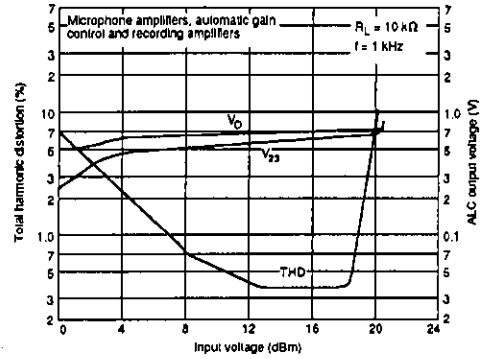

Tuner and recording amplifiers

Closed-loop voltage gain vs. frequency

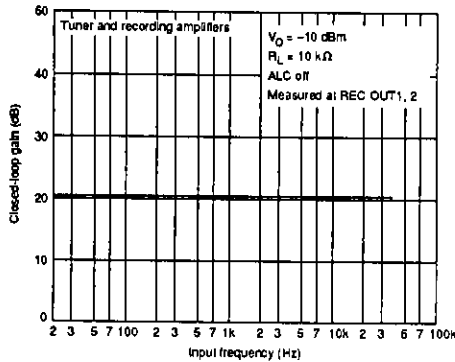

Total harmonic distortion and ALC output voltage vs. Input voltage

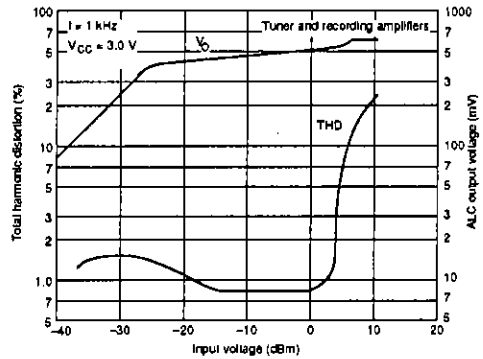

Total harmonic distortion and output voltage vs. Input voltage

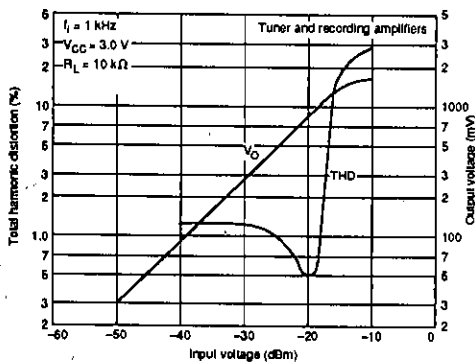

Maximum output voltage vs. supply voltage

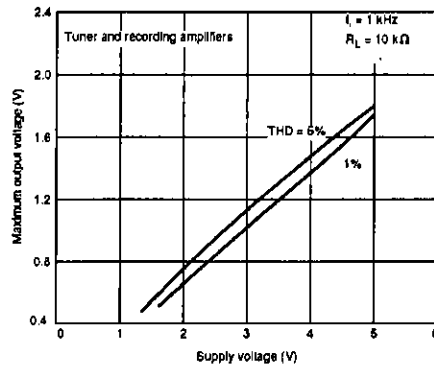

Output voltage vs. ambient temperature

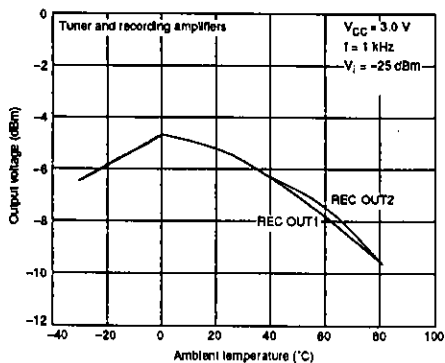

Crosstalk between channels vs. frequency

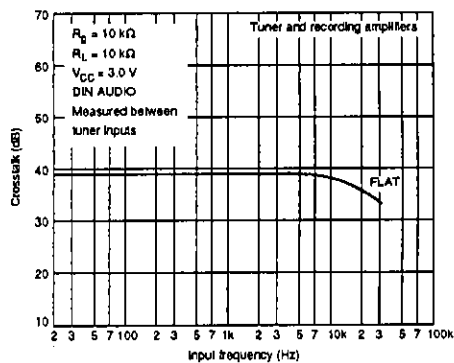

Recording amplifier

DC offset vs. ambient temperature

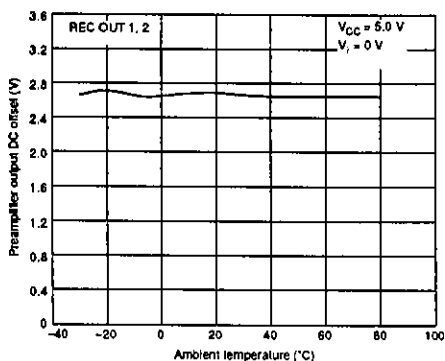

Reference voltages

VREF, preamplifier and logic reference voltages vs. ambient temperature (1)

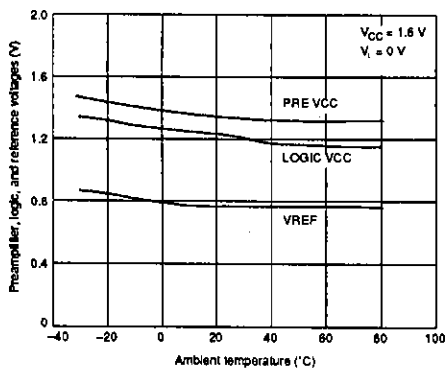

VREF, preamplifier and logic reference voltages vs. ambient temperature (2)

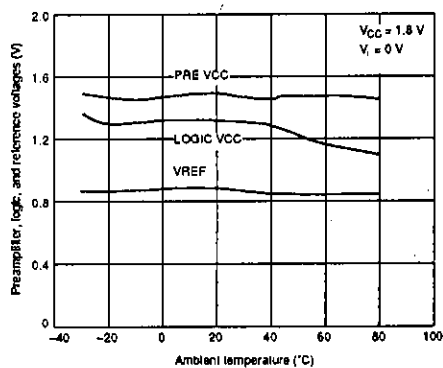

VREF, preamplifier and logic reference voltages vs. ambient temperature (3)

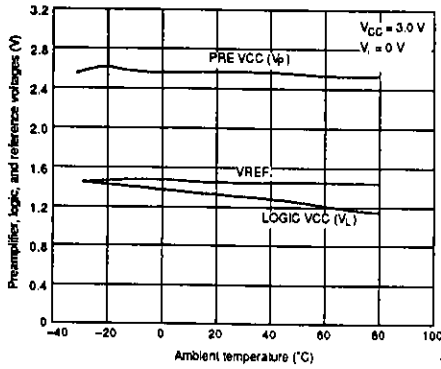

Preamplifier and logic reference voltages vs. supply voltage

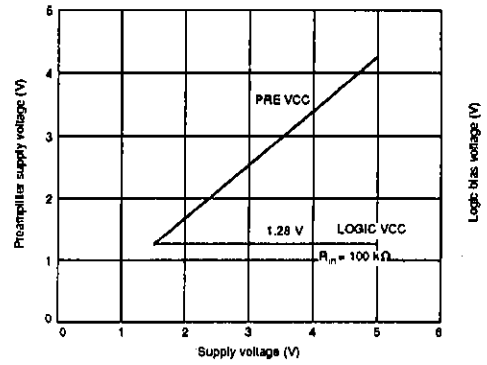

VREF, preamplifier and logic reference voltages vs. ambient temperature (4)

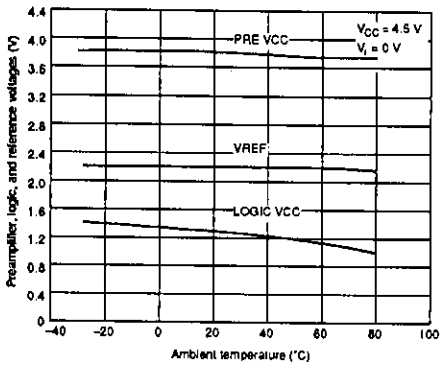

VREF vs. supply voltage

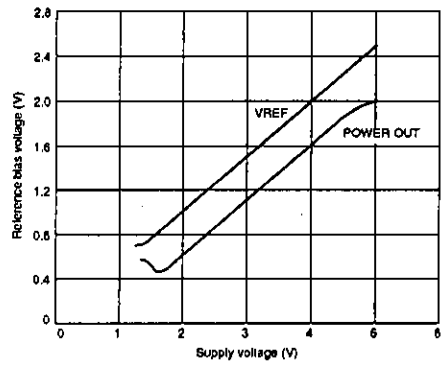

VREF, preamplifier and logic reference voltages vs. ambient temperature (5)

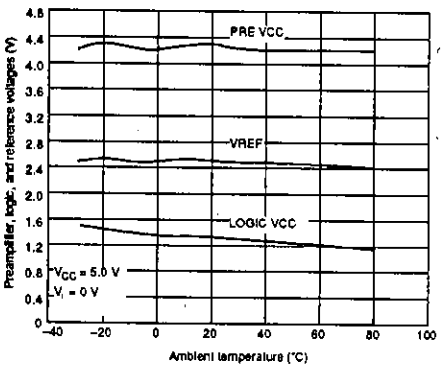

Microphone supply voltage vs. supply voltage

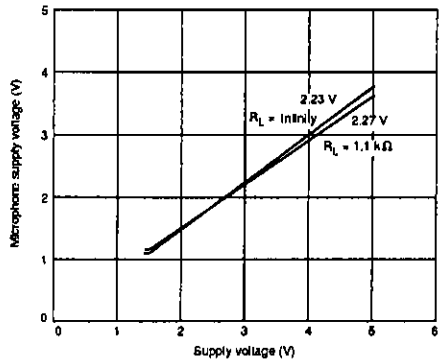

Tuner supply voltage vs. supply voltage

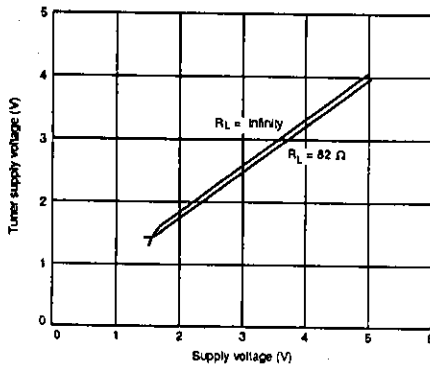

Bias oscillator supply voltage vs. supply voltage

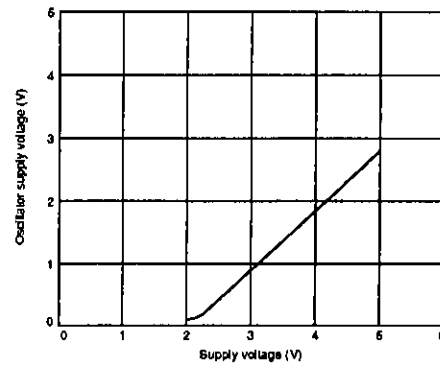

FUNCTIONAL DESCRIPTION

Recording Preamplifiers

The recording preamplifiers are coupled to an automatic gain control (AGC) circuit, which keeps the recording signal amplitude relatively constant for large variations in input amplitude. The AGC response time is set by a capacitor connected to AGC TIME. The gain and frequency responses of the recording preamplifiers are adjustable using the feedback networks connected to REC NF1 and REC NF2. The amplified recording signals are output on REC OUT1 and REC OUT2.

Microphone preamplifiers

MIC IN1 and MIC IN2 are the microphone preamplifier inputs. The gain and frequency responses are adjustable using the feedback networks connected to PRE NF1 and PRE NF2. The amplified microphone signals are output on MIC OUT1 and MIC OUT2 and are used as a signal source for the recording preamplifiers.

Tuner preamplifiers

TUNER IN1 and TUNER IN2 are the tuner preamplifier inputs. The buffered and amplified signals are output on MIC OUT1 and MIC OUT2 and are used as a signal source for the recording preamplifiers.

Playback Preamplifiers

PRE IN FWD L CH and PRE IN FWD R CH are the forward playback head preamplifier inputs, and PRE IN REV L CH and PRE IN REV R CH, the reverse playback head preamplifier inputs. The gain and frequency responses are adjustable using the feedback networks connected to PRE NF1 and PRE NF2. The amplified playback signals are output on PRE OUT1 and PRE OUT2.

Power Amplifiers

Output level control

Audio signals are attenuated using an electronic variable resistor (EVR) before being amplified. The level of this attenuation is controlled by the voltage on EVR CONT. An input voltage range of 0 to 1.3 V corresponds to the attenuation range from maximum to minimum attenuation, respectively.

Headphone and speaker amplifiers

The power amplifier section comprises three separate amplification channels—two for driving stereo headphones and one common amplifier for driving a low-impedance speaker. Signals are input to the headphone amplifiers on POWER IN1 and POWER IN2 and output on POWER OUT1 and POWER OUT2. The gain and frequency responses of the headphone amplifiers are adjustable using the feedback networks connected to POWER NF1 and POWER NF2. POWER NF1 and POWER NF2 should be connected to VREF through coupling capacitors. The two headphone outputs should be mixed together, then input on SPKR DRIVE IN. The resulting amplified mono signal is output on SPKR DRIVE.

Reference Voltages

Power amplifier reference voltage

The reference voltage at VREF is biased to $0.5V_{CC}$ and can be used as a virtual earth because the output impedance is less than 1Ω .

The capacitor on FILTER is used to reduce ripple on the reference voltage. A value between 22 and 33 μF is recommended. Larger values increase the power supply startup time. Smaller values can cause an unacceptable amount of ripple.

External microphone supply

The reference voltage at MIC VCC is biased to $0.75V_{CC}$ and is used to power external electret condenser microphones.

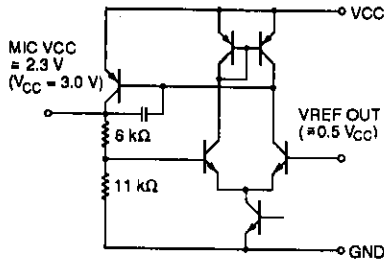

Figure 1. Microphone supply

Bias oscillator supply

The reference voltage at OSC VCC is biased to $(V_{CC} - 2)$ V and is used to power an external recording bias oscillator.

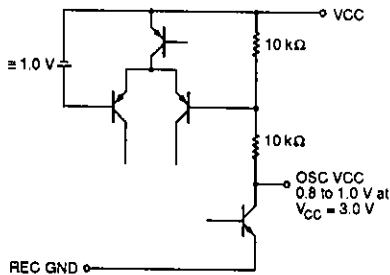

Figure 2. Oscillator supply

Operating Mode Inputs

Tape/tuner/standby modes

VCC/TAPE/TUNER controls the primary operating mode of the LA4583M. When VCC/TAPE/TUNER is connected directly to VCC, the tuner circuits are selected and the tuner supply voltage is output on TUN VCC OUT. TUN VCC CONT can also be used with an external transistor, such as an 2SA608, to supply other circuits while in tuner mode. When VCC/TAPE/TUNER is connected to VCC through an 82 kΩ resistor, the tape circuits are selected. When this pin is left unconnected, the device goes into standby mode.

Microphone recording monitor

REC MONITOR ON OFF enables and disables monitoring of the microphone signal during recording. When REC MONITOR ON OFF is connected to ground, the signal being recorded is sent to the headphone outputs.

Preamplifier reference

The reference voltage at PRE VCC is biased to $0.42V_{CC}$ and is used to power the internal playback, microphone and tuner preamplifiers.

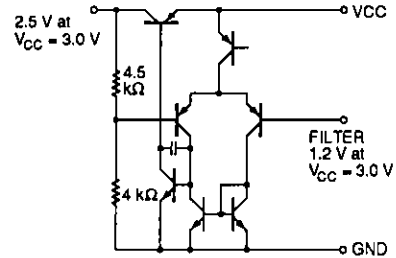

Figure 3. Preamplifier reference

Playback direction and recording control

When REC/PLAY/REV CONT is left unconnected, forward playback is selected. When REC/PLAY/REV is connected to ground through a 20 kΩ resistor, reverse playback is selected. When REC/PLAY/REV is connected to VREF, recording mode is selected.

Mute

Muting is activated when the operating mode is changed, greatly reducing mode switching noise. Muting is released after a delay determined by the capacitor on MUTE TIME C. The delay is approximately 0.4 s with a 4.7 μF capacitor. The voltage change on this pin and the resulting mute duration is shown in figure 4.

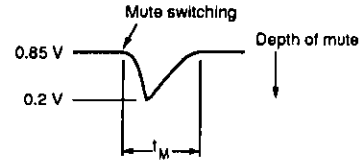

Figure 4. Mute timing

DESIGN INFORMATION

Voltage Gain in Different Modes

Playback preamplifiers and power amplifiers

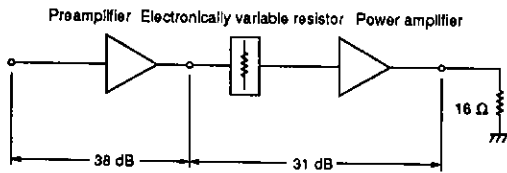

Figure 5. Preamplifier gain

The preamplifier voltage gain can be adjusted using a resistor on the negative feedback inputs. The voltage gain should be kept above 25 dB, otherwise spurious oscillation can occur. The power amplifier gain is fixed at 31 dB. Reducing the power amplifier load to 32 Ω increases the gain by approximately 1 dB.

Common power amplifier

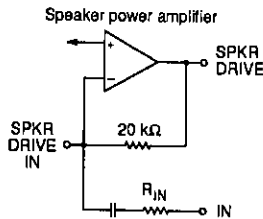

Figure 6. Power amplifier gain

Voltage gain calculation

The gain of the common power amplifier can be varied by altering the feedback resistor R_{IN} as shown in the following equation. R_{IN} can be set to ∞ if a low output impedance is required.

$$VG = 20 \times \log_{10}((20 \text{ k}\Omega) / R_{IN})$$

Microphone and recording amplifiers

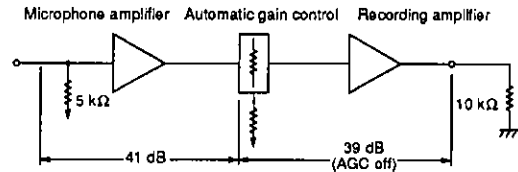

Figure 7. Microphone amplifier gain

The input impedance of the microphone amplifier is 5 kΩ. As the feedback resistor is 27 kΩ, care should be taken to limit the gain when using electret condenser microphones.

Voltage gain calculation

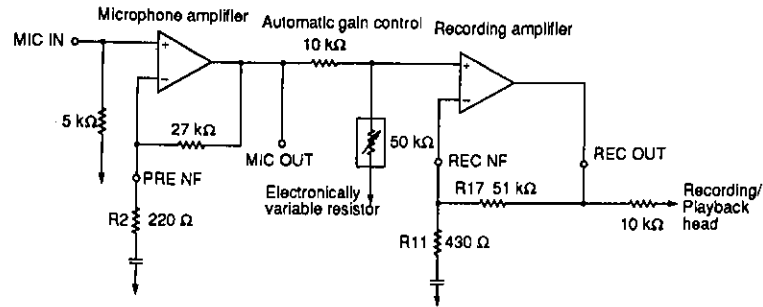

Figure 8. Microphone amplifier

Microphone amplifier gain

$$VG_{MR} = 20 \times \log_{10}((27 \text{ k}\Omega) / R22)$$

The microphone amplifier gain should be above 25 dB.

Recording amplifier gain

$$VG_{RR} = 20 \times \log_{10}((51 \text{ k}\Omega) / R11)$$

Tuner and recording amplifiers

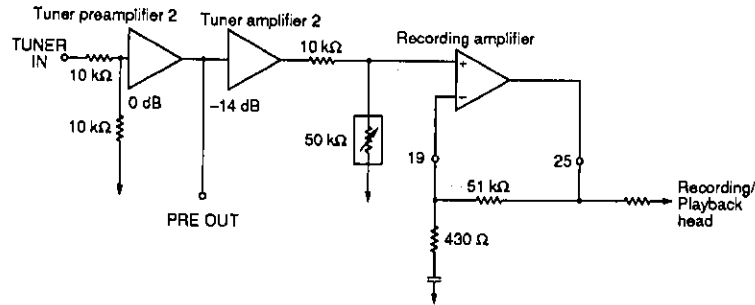

Figure 9. Tuner amplifier

The total gain of the tuner preamplifier and recording amplifier can be calculated as follows.

$$VG_{TR} = (20 \times \log_{10}((51 \text{ k}\Omega) / R11) - 14 \text{ dB})$$

APPLICATION NOTES

Typical Application

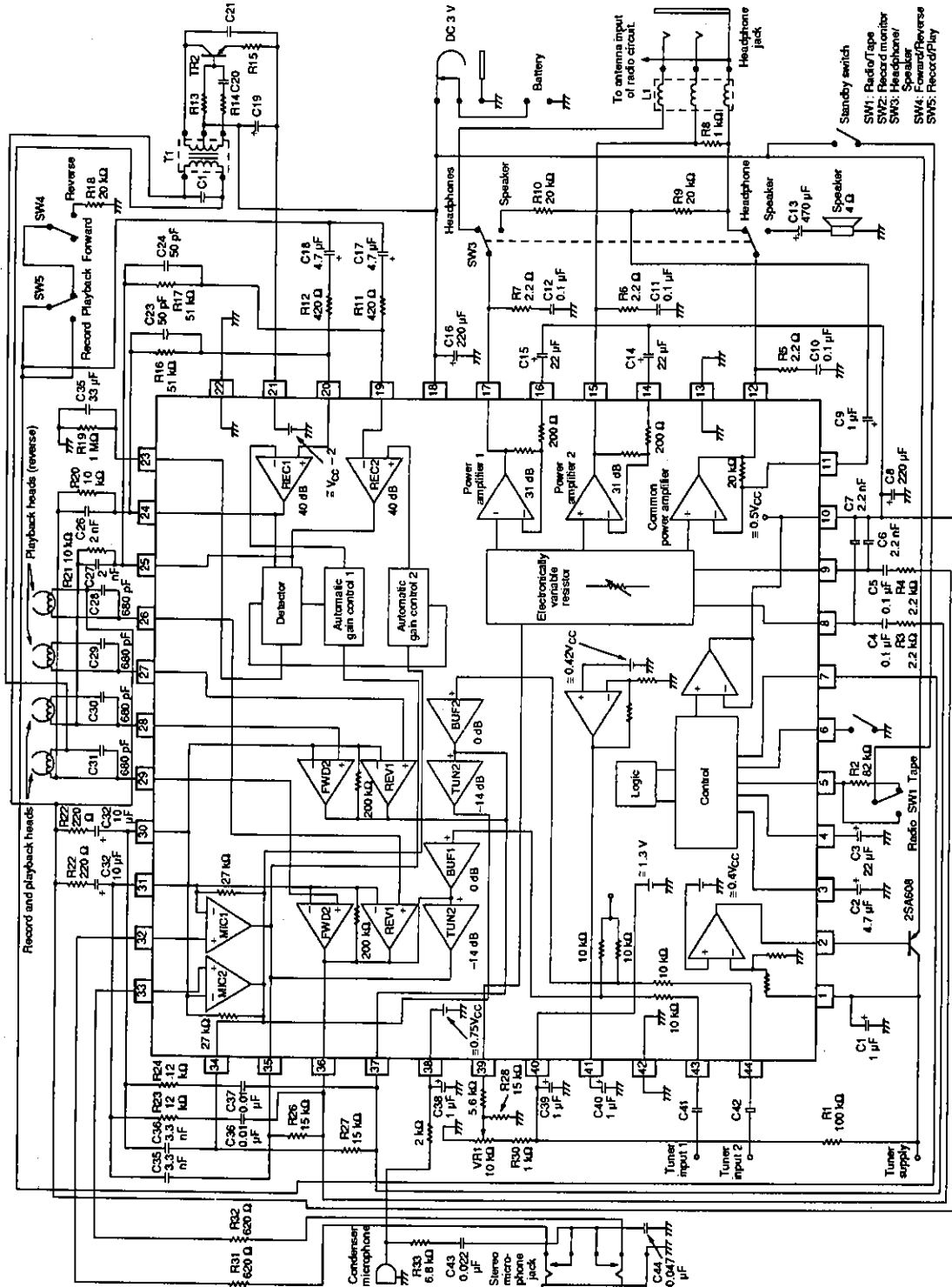

Figure 10. Typical application

Description of external components

Microphone preamplifiers

MIC VCC supplies power to an external electret condenser microphone through a current limiting resistor and a decoupling capacitor, C38. A value between 1 and 3.3 μF should be chosen. R33 and C43 couple the audio signal to the MIC IN inputs and should be selected according to the microphone used. R31 and R32 are included as static discharge protection for the preamplifier inputs. A value between 510 and 1 k Ω should be used. R22, R23, C32 and C33 are placed in the negative feedback path of the microphone and playback preamplifiers to create a low-frequency cutoff of 40 Hz. Values should be chosen from those in the following table.

R22, R23	C32, C33
100 Ω	33 μF
200 Ω	22 μF
300 Ω	10 μF
400 Ω	4.7 μF

C35 and C36 are highpass filter capacitors which, in conjunction with the internal 27 k Ω feedback resistors, remove noise from the microphone inputs. A value between 2.2 and 4.7 μF should be used. R22 and R23 set the gain of the microphone and playback preamplifiers. A value between 100 and 390 Ω should be used. R26 and R27 are used to connect the microphone outputs to the power amplifier inputs for record mode monitoring. A value of 15 k Ω is recommended.

Playback preamplifiers

C28 to C31 are the playback head highpass filter capacitors and should be selected to suit the head used. Values between 330 and 2200 pF are recommended. C36 and C37 are the equalization curve setting capacitors. A value should be selected to suit the manufacturer's specifications.

Recording amplifiers

R11, R12, R16 and R17 set the recording amplifier voltage gain. Values of 420 Ω for R11 and R12, and 51 k Ω for R16 and R17 are recommended. C23 and C24 are placed in parallel with R16 and R17 to reduce ringing on the recording amplifier outputs. A value between 30 and 50 pF should be used. C17 and C18 are negative feedback capacitors and should be connected so that the positive poles are connected to pins 19 and 20. A value of 4.7 μF is recommended. C26 and C27 perform highpass filtering on the outputs and should be selected to suit the manufacturer's specifications. R20 and R21 represent the load on the outputs. A value of 10 k Ω is recommended.

The AGC circuit coupled to the recording amplifier has a response that is dependent on the values of R19 and C25. R19 sets the attack time and C25 sets the recovery time. A value between 300 k Ω and 2 M Ω should be used for R19, and 22 to 47 μF , for C25.

Power amplifiers

C4 and C5 couple the preamplifier outputs to the power amplifier inputs. Connect the positive poles towards the preamplifier inputs and select a value between 0.1 and 1 μF . R3, R4, C6 and C7 form highpass filters for audio signals entering the power amplifiers. A value between 0 and 3 k Ω should be used for R3 and R4, and 560 to 2200 pF, for C6 and C7. C14 and C15 are the negative feedback capacitors for the headphone amplifiers. Connect the positive poles toward the outputs and choose a value between 10 and 22 μF . The low-frequency cutoff is approximately 36 Hz with 22 μF capacitors. On the output of each channel is an RC network designed to suppress unwanted oscillation. A value between 1.5 and 3.0 k Ω should be chosen for resistors R5 to R7. The corresponding capacitors, C10 to C12, should be 0.1 μF ceramic capacitors.

The two output channels of the headphone amplifiers are combined and input on SPKR DRIVE IN, the input to the common power amplifier. The recommended circuit is shown in figure 11. Resistor values should be selected from the following equations.

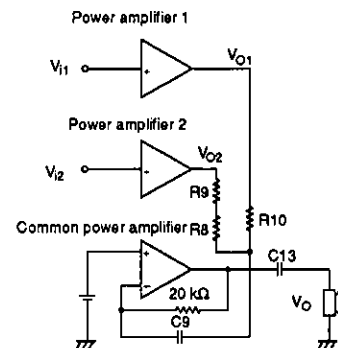

Figure 11. Speaker drive circuit

Note

R8 = 1 to 2 k Ω

R9 and R10 = 20 k Ω

$$V_o = 31 \text{ dB} \times ((40 \text{ k}\Omega) / R_9) \times V_i$$

If $R_9 = R_{10}$ and $R_9 \gg R_8$, then

$$V_o = (V_{o1} / R_{10} + V_{o2} / R_9) \times (20 \text{ k}\Omega)$$

If $V_{o1} = V_{o2} = V_o'$, then

$$V_{i1} = V_{i2} = V_i$$

$$V_o = V_o' (2/R_9) \times (20 \text{ k}\Omega)$$

$$= V_o' ((40 \text{ k}\Omega) / R_9)$$

The output of the common amplifier is used to drive a low-impedance speaker through a coupling capacitor, C13. A value between 220 and 470 μF should be selected, however, a 470 μF capacitor is recommended if high output is required.

Tuner preamplifiers

C41 and C42 are coupling capacitors for the TUN IN1 and TUN IN2 inputs. A value between 0.01 and 0.1 μF should be used.

Mode selection and switching

R2 is used with VCC/TAPE/TUNER CONT. This tristate input requires a resistor connected to VCC to activate the tape circuits. A value between 70 and 90 $\text{k}\Omega$ can be chosen, however, 82 $\text{k}\Omega$ is the recommended value.

R18 is used with REC/PLAY/REV CONT. This tristate input requires a resistor connected to ground to select reverse playback. A value between 15 and 24 $\text{k}\Omega$ can be chosen, however, 20 $\text{k}\Omega$ is the recommended value.

R1 is the tuner power supply startup resistor. If not present, tuner power supply operation is not guaranteed. A value between 50 and 100 $\text{k}\Omega$ should be used.

The capacitor on MUTE TIME C, C2, determines the mute time. A value of 4.7 μF will result in a mute time of approximately 0.4 s.

External bias oscillator circuit

The values of all components related to the external bias oscillator circuit, R13 to R15 and C19 to C22, should be selected according to the manufacturers specifications.

Electronic variable resistor (EVR)

R28 sets the minimum output signal level. A value of 15 $\text{k}\Omega$ is recommended. R29 sets the maximum output signal level for which a value of 5.6 $\text{k}\Omega$ is recommended. R30 has been added to protect the EVR input from damage due to static discharge.

Supply and reference voltages

C1 is the tuner power supply decoupling capacitor. A value between 1 and 10 μF should be used. C3 is the ripple filter capacitor for the reference voltage for which a value of 22 μF is recommended. C8 is the reference bias decoupling capacitor for which a value of 220 μF is recommended. C16 decouples the LA4583M supply. Again, a value of 220 μF is recommended.

C39 is both the logic supply decoupling capacitor and oscillation suppressor for which a value between 0.01 and 0.1 μF should be used. C40 decouples the preamplifier bias supply for which a value between 4.7 and 10 μF should be selected.

- No products described or contained herein are intended for use in surgical implants, life-support systems, aerospace equipment, nuclear power control systems, vehicles, disaster/crime-prevention equipment and the like, the failure of which may directly or indirectly cause injury, death or property loss.
- Anyone purchasing any products described or contained herein for an above-mentioned use shall:
 - ① Accept full responsibility and indemnify and defend SANYO ELECTRIC CO., LTD., its affiliates, subsidiaries and distributors and all their officers and employees, jointly and severally, against any and all claims and litigation and all damages, cost and expenses associated with such use;
 - ② Not impose any responsibility for any fault or negligence which may be cited in any such claim or litigation on SANYO ELECTRIC CO., LTD., its affiliates, subsidiaries and distributors or any of their officers and employees jointly or severally.
- Information (including circuit diagrams and circuit parameters) herein is for example only; it is not guaranteed for volume production. SANYO believes information herein is accurate and reliable, but no guarantees are made or implied regarding its use or any infringements of intellectual property rights or other rights of third parties.