



SANYO Semiconductors

DATA SHEET

An ON Semiconductor Company

LA59700MX

Monolithic Linear IC Adjustable Voltage Type Regulator

Overview

LA59700MX is an adjustable voltage regulator which has chip enable function.

The maximum current of 1.0A can be output.

Features

- Adjustable output voltage
- Maximum output current: 1.0A
- Chip enable function
- Build-in over current protection circuit
- Available ceramic capacitors

Specifications

Maximum Ratings at $T_a = 25^\circ\text{C}$

Parameter	Symbol	Conditions	Ratings	Unit
Maximum supply voltage	$V_{CC \text{ max}}$		16	V
Maximum input voltage	$V_{IN \text{ max}}$		16	V
Allowable power dissipation	$P_d \text{ max}$	Mounted on a specified board *1	1.8	W
Operating temperature	T_{opr}		-40 to +85	$^\circ\text{C}$
Storage temperature	T_{stg}		-55 to +150	$^\circ\text{C}$

*1. Specified board: 50mm × 50mm × 1.6mm, glass epoxy double side board.

■ Any and all SANYO Semiconductor Co.,Ltd. products described or contained herein are, with regard to "standard application", intended for the use as general electronics equipment (home appliances, AV equipment, communication device, office equipment, industrial equipment etc.). The products mentioned herein shall not be intended for use for any "special application" (medical equipment whose purpose is to sustain life, aerospace instrument, nuclear control device, burning appliances, transportation machine, traffic signal system, safety equipment etc.) that shall require extremely high level of reliability and can directly threaten human lives in case of failure or malfunction of the product or may cause harm to human bodies, nor shall they grant any guarantee thereof. If you should intend to use our products for applications outside the standard applications of our customer who is considering such use and/or outside the scope of our intended standard applications, please consult with us prior to the intended use. If there is no consultation or inquiry before the intended use, our customer shall be solely responsible for the use.

■ Specifications of any and all SANYO Semiconductor Co.,Ltd. products described or contained herein stipulate the performance, characteristics, and functions of the described products in the independent state, and are not guarantees of the performance, characteristics, and functions of the described products as mounted in the customer's products or equipment. To verify symptoms and states that cannot be evaluated in an independent device, the customer should always evaluate and test devices mounted in the customer's products or equipment.

LA59700MX

Recommended Operating Conditions at Ta = 25°C

Parameter	Symbol	Conditions	Ratings	Unit
Input Voltage (V _{CC1})	V _{CC1}		3.5 to 15	V
Input Voltage (V _{CC2})	V _{CC2}		*2 (V _{OUT} +V _{DROP}) to 15	V
Input Voltage(EN)	V _{EN}		0 to 15	V
Output Voltage	V _{OUT}		1.5 to (V _{CC1} -1.5)	V

*2. V_{DROP}: Dropout voltage

Electrical Characteristics at Ta = 25°C, V_{CC1} = V_{CC2} = 3.5V, V_{EN} = 1.6V, V_{OUT} = 1.5V

Parameter	Symbol	Conditions	Ratings			Unit
			min	typ	max	
Current drain	I _{CC}	V _{EN} = 1.6V		3.5	7	mA
Standby current	I _{STBY}	V _{EN} = 0V			1	μA
Output voltage	V _{OUT}	OUT = ADJ, I _{OUT} = 10mA,	1.225	1.25	1.275	V
Output current	I _{OUT}		1.0			A
Dropout voltage (V _{CC2} -V _{OUT})	V _{DROP}	I _{OUT} = 500mA		0.42	0.6	V
		I _{OUT} = 1.0A		0.84	1.2	V
ADJ source current	I _{ADJ}	ADJ = 0V, OUT = Open		160	300	nA
Load regulation	R _{LD}	I _{OUT} = 10mA to 500mA			10	mV
Line regulation	R _{LN}	V _{CC1} = V _{CC2} = 3.5V to 7V, I _{OUT} = 10mA			10	mV
Output voltage temperature coefficient *3	ΔV / ΔT	Ta = -40 to +85°C, I _{OUT} = 10mA		±100		ppm/°C
Ripple rejection *3	R _{RR}	V _{CC1} = V _{CC2} = 4.25V, OUT = ADJ, I _{OUT} = 10mA, V _{Rpp} = 1V, f _{RR} = 120Hz, C _{OUT} = Ceramic 10μF		65		dB
Chip enable voltage	V _{EN}		1.6			V
Disable voltage	V _{DIS}				0.4	V
EN input current	I _{EN}	V _{EN} = 1.6V		50		μA
Thermal shutdown temperature *3	T _{TSD}	Junction Temperature		170		°C
TSD hysteresis *3	T _{HYS}			30		°C

*3. Design guarantee value, Do not measurement.

Package Dimensions

unit : mm (typ)

3372

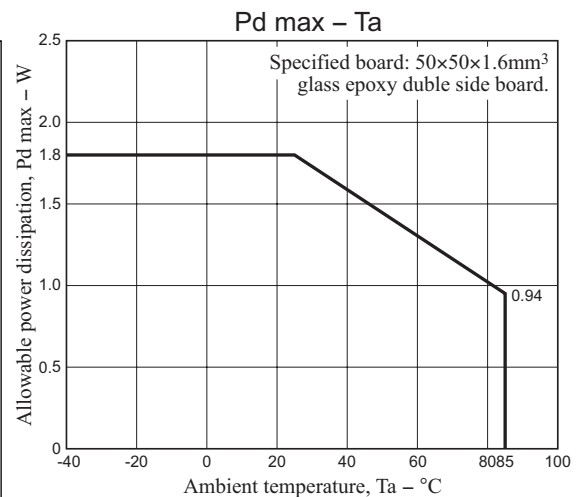
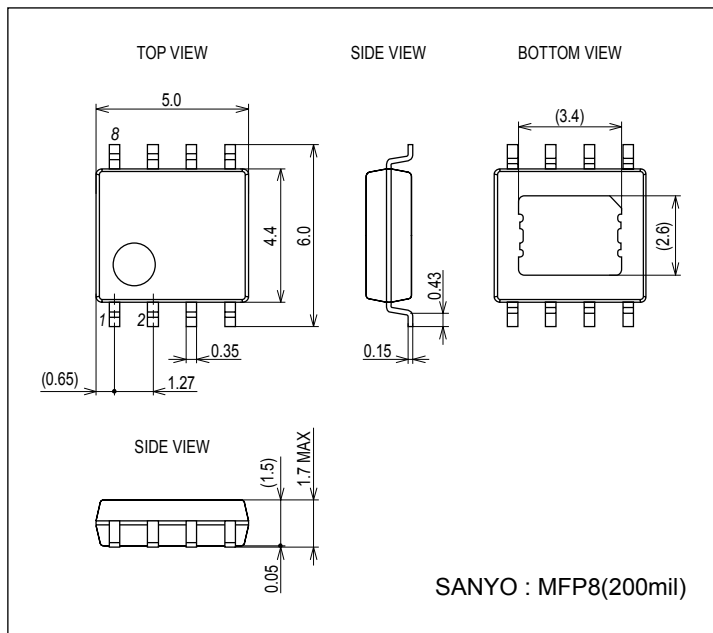

LA59700MX

Specified Board (50mm × 50mm × 1.6mm, glass epoxy double side board)

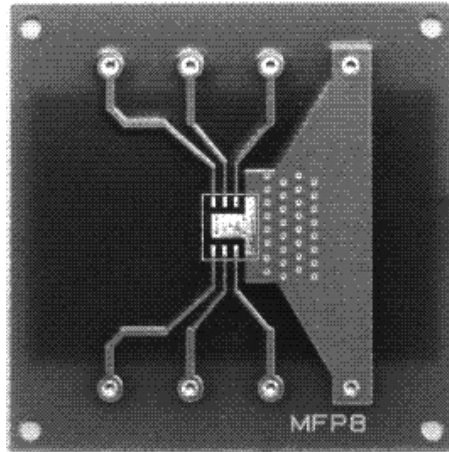

Pin Assignment

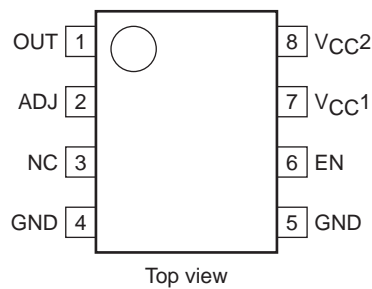

Block Diagram and Application Circuit Example

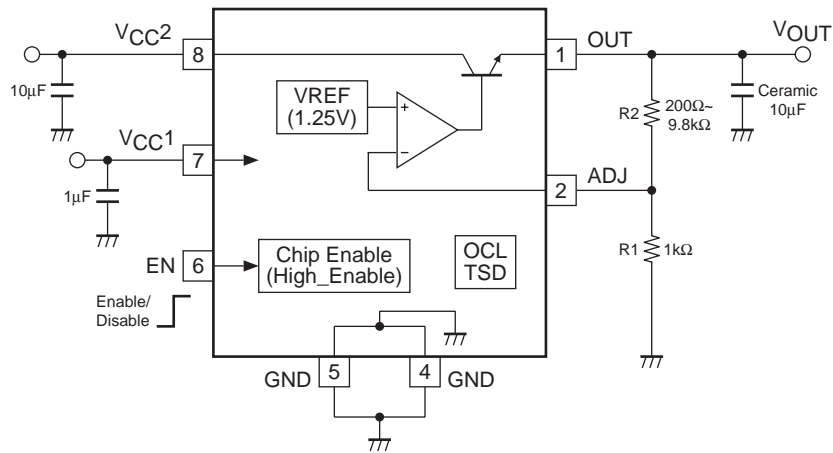

Formula of Output Voltage Adjustment

$$V_{OUT} = V_{ADJ} (\approx 1.25V) \times (R1+R2)/R1$$

Note: Set the resistance of R1 and R2 so that a large enough current flows through the two resistors, making the effect on the source current from the ADJ pin negligible.

Startup Method

This IC can be started in one of the following two ways:

- (1) Start the IC by turning on and off the EN pin after applying power to VCC1 and VCC2.
- (2) Short-circuit the VCC1, VCC2, and EN pins.

When using method (1), apply power to VCC1 and VCC2 simultaneously, or in the order of VCC1 to VCC2, then to the EN pin.

To shutdown the IC, follow the start-up procedure in reverse order.

LA59700MX

Pin Function

Pin No.	Pin name	Function	Equivalent circuit
1	OUT	Output.	
2	ADJ	Adjustable input.	
3	NC	No connection.	
4	GND	Ground. Connect to Pin 5 internally.	
5	GND	Ground. Connect to Pin 4 internally.	
6	EN	Chip Enable. (High Enable)	
7	V _{CC1}	Analog power supply.	
8	V _{CC2}	Output power supply.	

LA59700MX

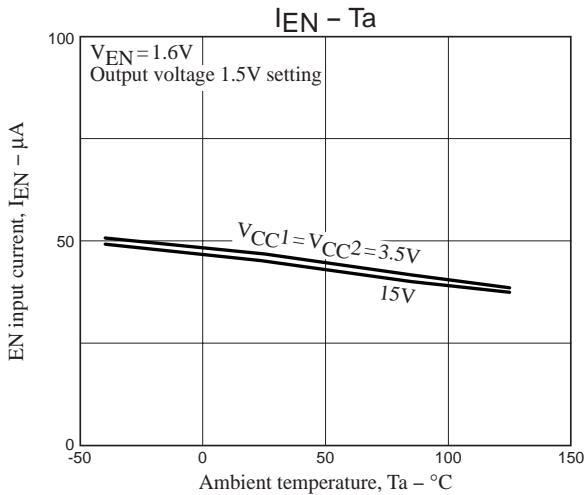
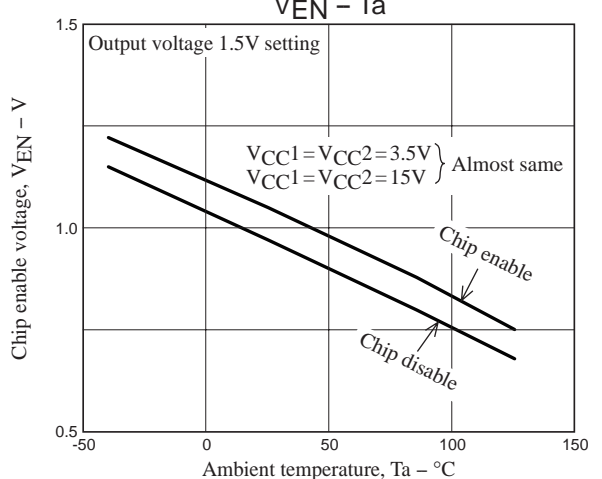
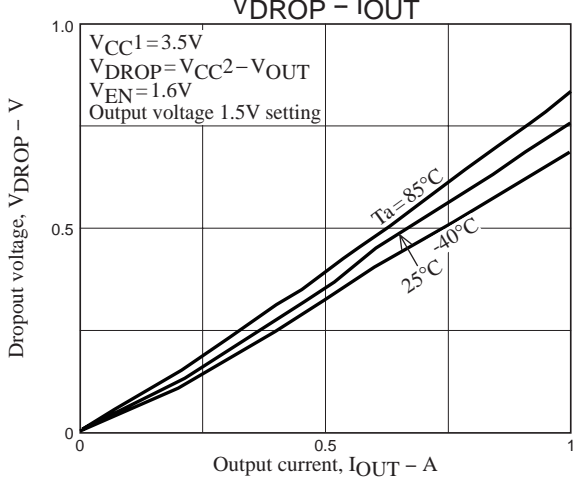
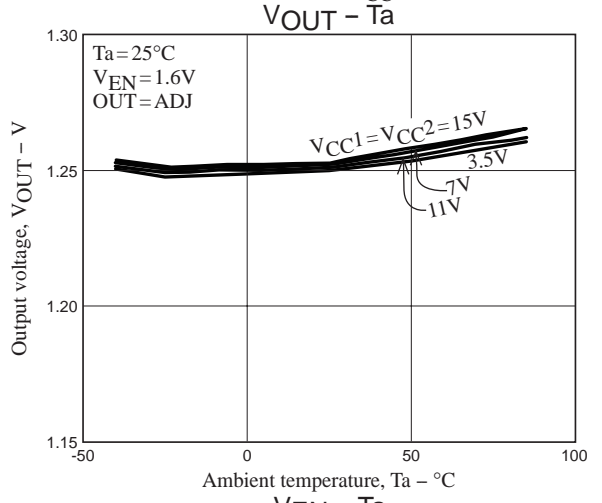
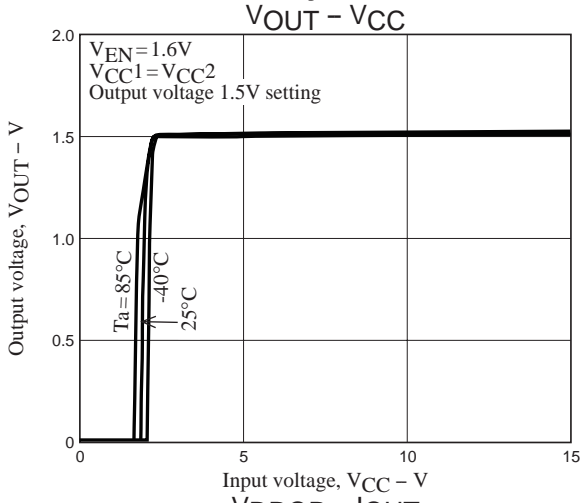
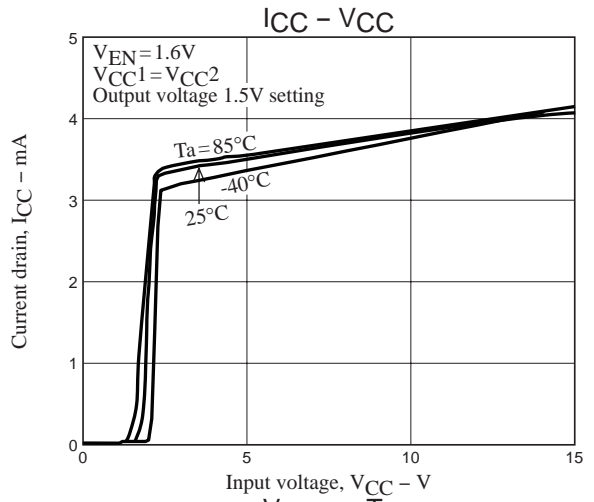
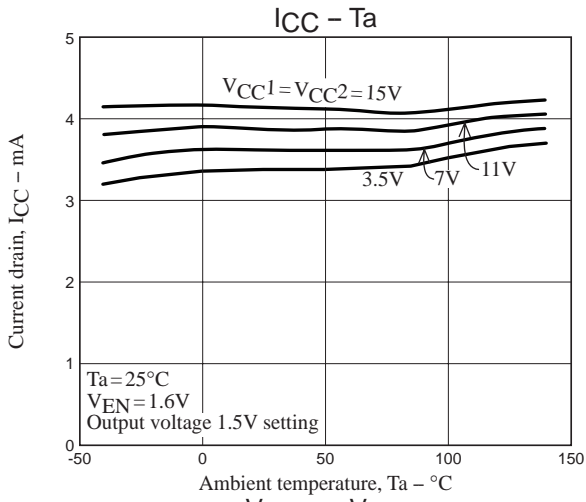

LA59700MX

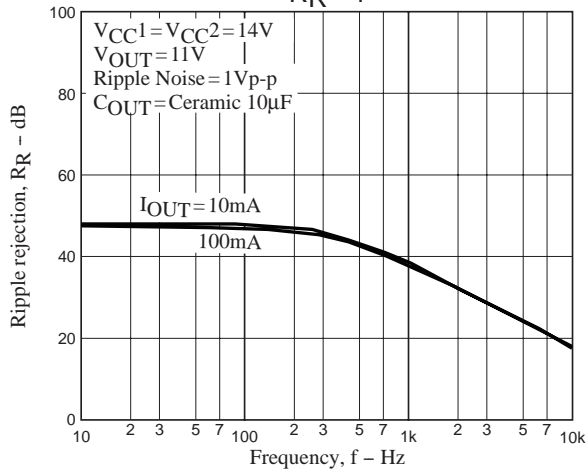
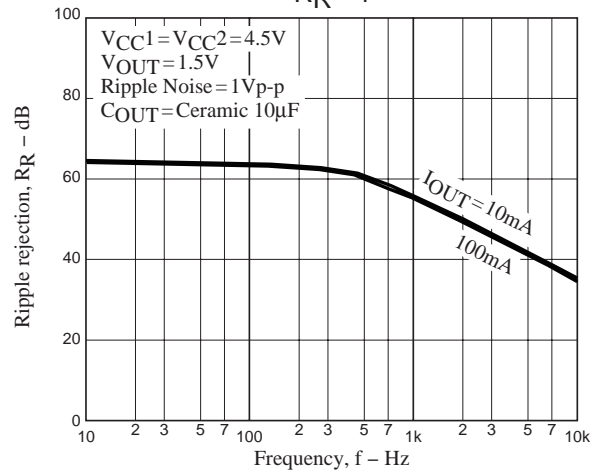
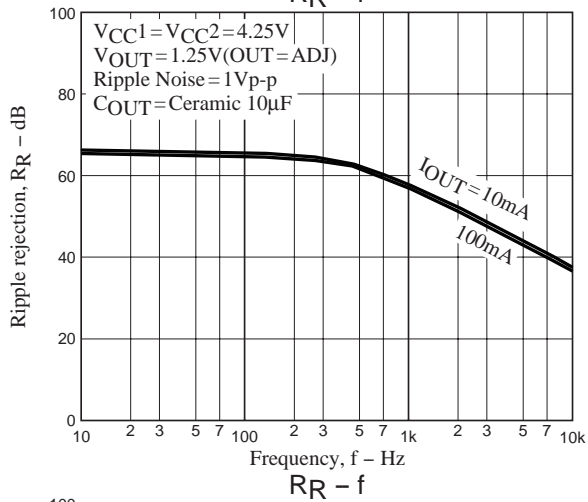
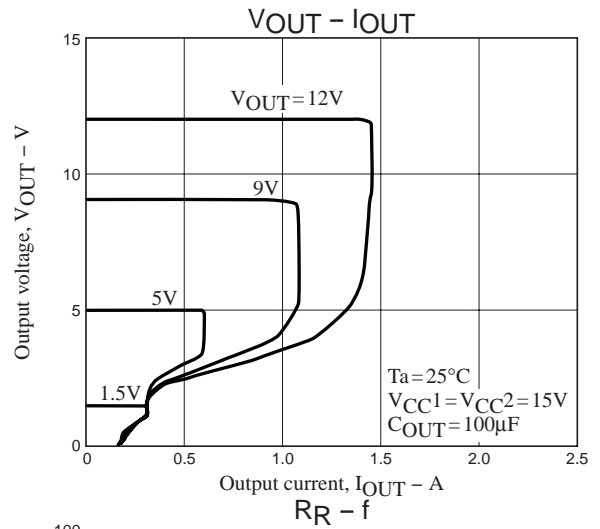
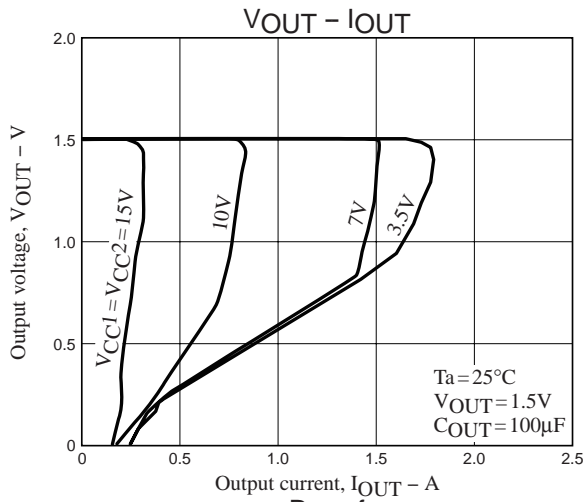

V_{OUT} Startup Characteristic

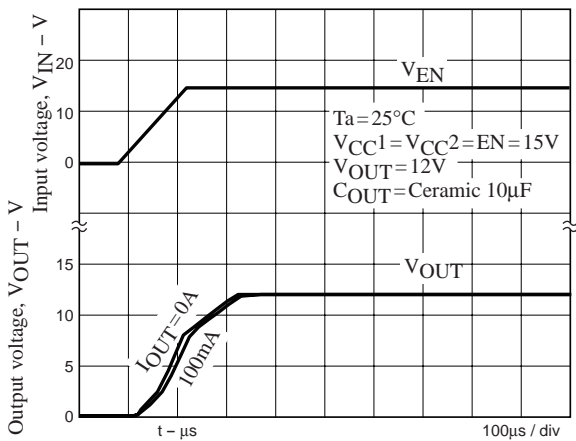
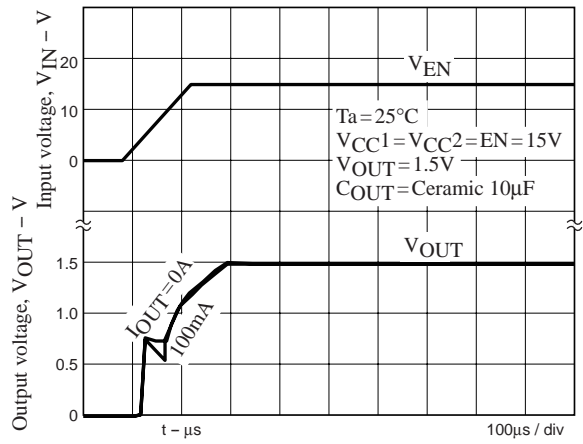
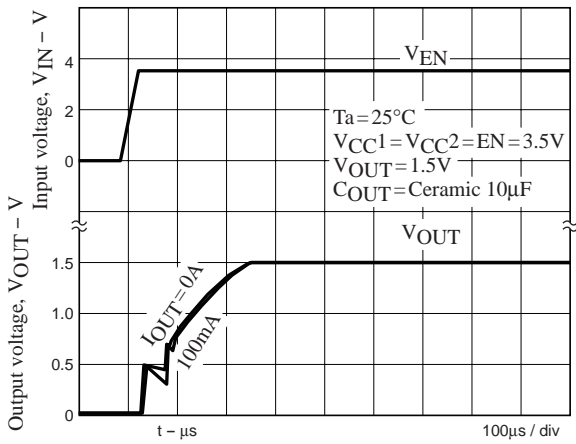
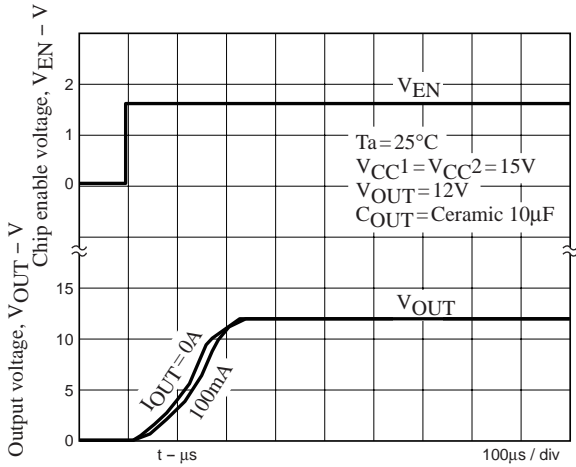
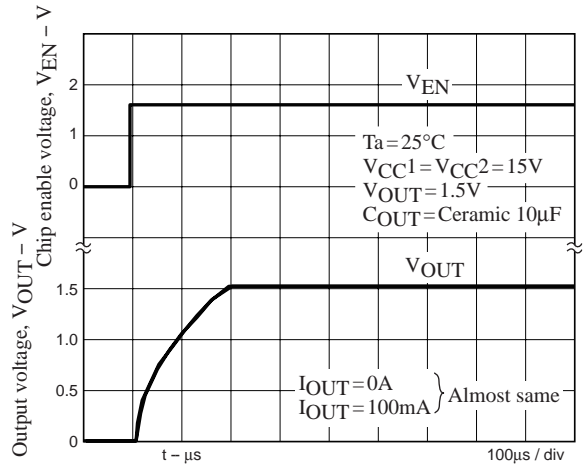
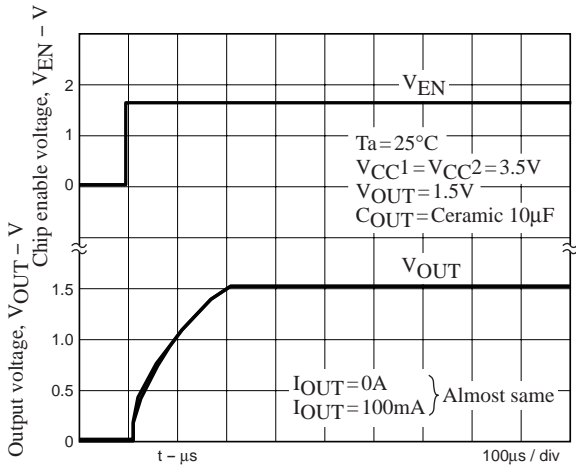

Note: The output voltage (V_{OUT}) may overshoot when V_{IN} starts up with slew rate of a voltage of 0.1V/ μs or over.

Load Transient Response Characteristics

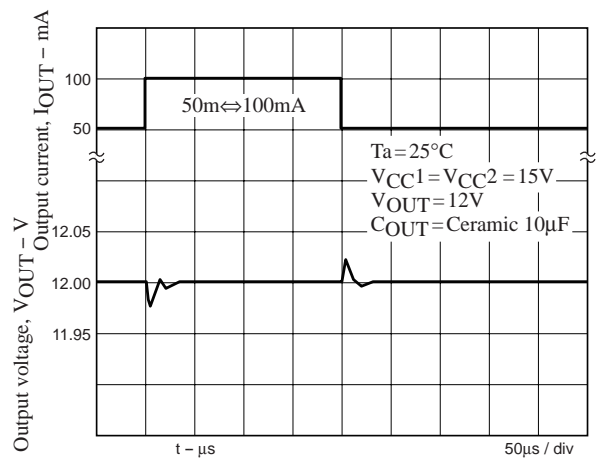
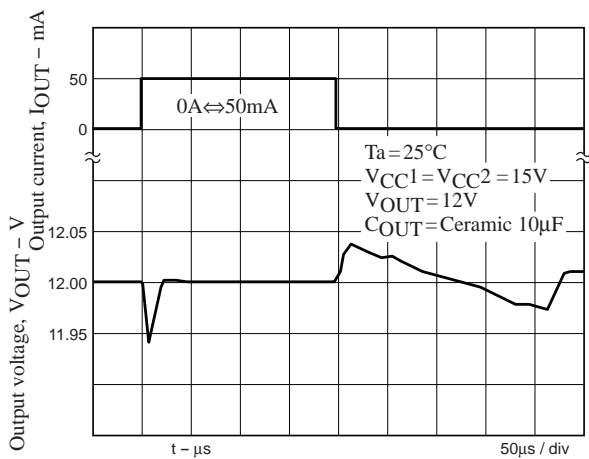
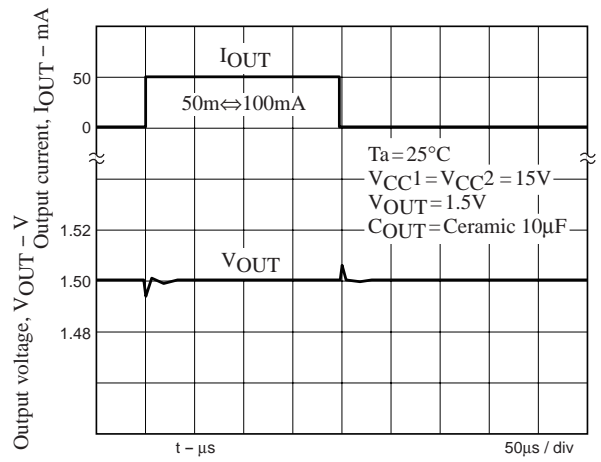
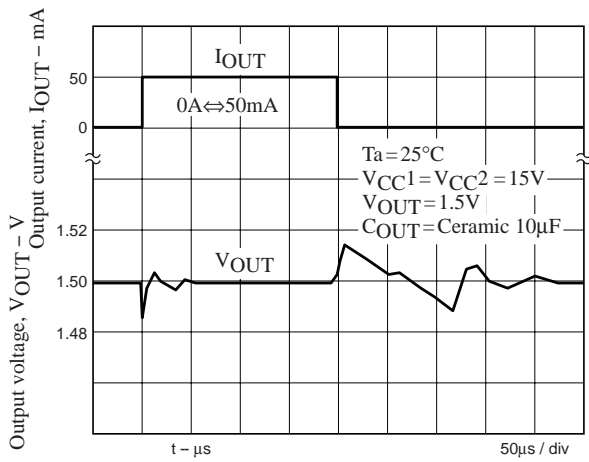
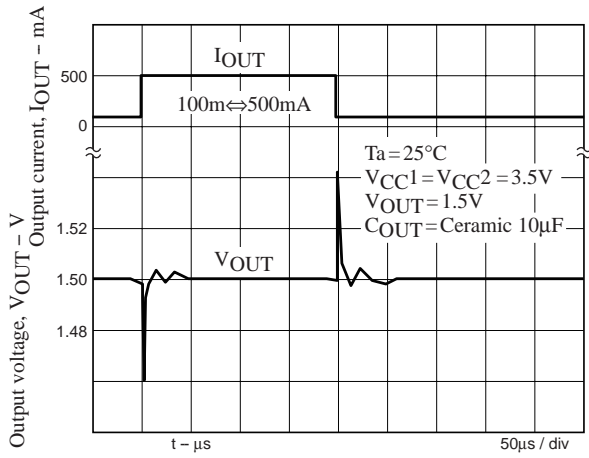
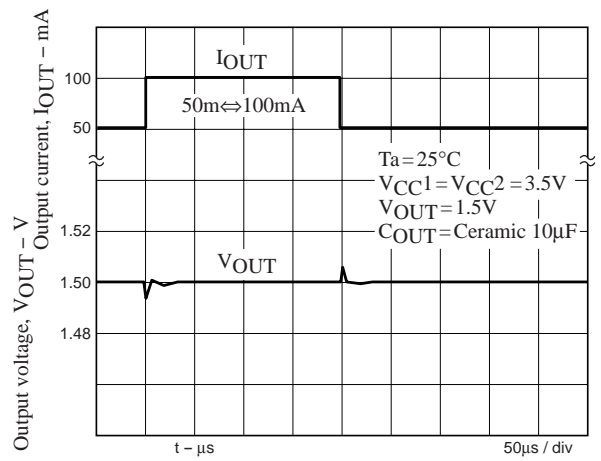
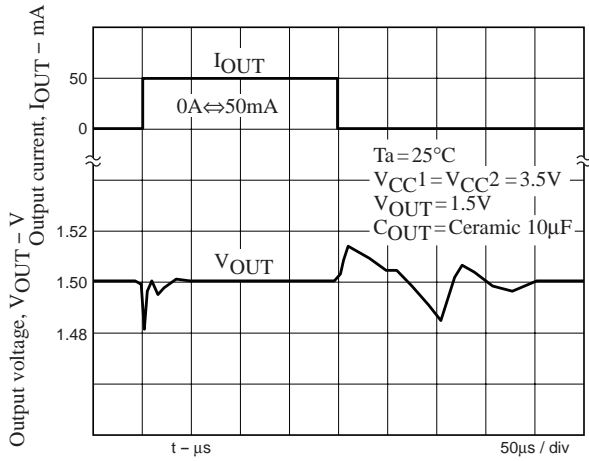

LA59700MX

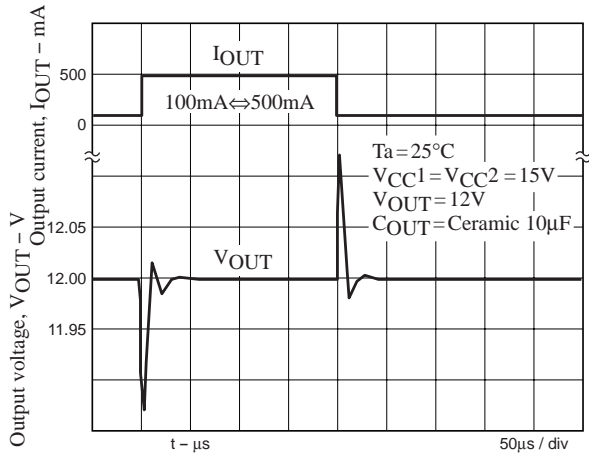

- SANYO Semiconductor Co.,Ltd. assumes no responsibility for equipment failures that result from using products at values that exceed, even momentarily, rated values (such as maximum ratings, operating condition ranges, or other parameters) listed in products specifications of any and all SANYO Semiconductor Co.,Ltd. products described or contained herein.
- SANYO Semiconductor Co.,Ltd. strives to supply high-quality high-reliability products, however, any and all semiconductor products fail or malfunction with some probability. It is possible that these probabilistic failures or malfunction could give rise to accidents or events that could endanger human lives, trouble that could give rise to smoke or fire, or accidents that could cause damage to other property. When designing equipment, adopt safety measures so that these kinds of accidents or events cannot occur. Such measures include but are not limited to protective circuits and error prevention circuits for safe design, redundant design, and structural design.
- In the event that any or all SANYO Semiconductor Co.,Ltd. products described or contained herein are controlled under any of applicable local export control laws and regulations, such products may require the export license from the authorities concerned in accordance with the above law.
- No part of this publication may be reproduced or transmitted in any form or by any means, electronic or mechanical, including photocopying and recording, or any information storage or retrieval system, or otherwise, without the prior written consent of SANYO Semiconductor Co.,Ltd.
- Any and all information described or contained herein are subject to change without notice due to product/technology improvement, etc. When designing equipment, refer to the "Delivery Specification" for the SANYO Semiconductor Co.,Ltd. product that you intend to use.
- Information (including circuit diagrams and circuit parameters) herein is for example only; it is not guaranteed for volume production.
- Upon using the technical information or products described herein, neither warranty nor license shall be granted with regard to intellectual property rights or any other rights of SANYO Semiconductor Co.,Ltd. or any third party. SANYO Semiconductor Co.,Ltd. shall not be liable for any claim or suits with regard to a third party's intellectual property rights which has resulted from the use of the technical information and products mentioned above.

This catalog provides information as of February, 2009. Specifications and information herein are subject to change without notice.