

<b>SANYO</b>	No.3090	<b>LA7316A-N,7316AM</b>
	<b>VCR VHS Chroma Signal Processor</b>	

The LA7316A-N,7316AM are VHS chroma signal processor ICs that have the following features.

1. Adjustment-free 3.58MHz VXO free-running OSC frequency, 160f<sub>H</sub> VCO free-running OSC frequency, carrier leak, PB chroma level, except REC chroma level
2. The chip size is greatly reduced by using our most advanced process technology for fine structure. Since the LA7316A-N, 7316AM are designed for NTSC system, the package can be made so small as the DIP-24S and a minimum number of external parts is required and it occupies much less space on the board, thereby facilitating VCR set design.
3. Multifunction  
2f<sub>SC</sub> generator for CCD drive, PB chroma (629k) level compensation amp, function to select APC loop input signal passed/not passed through comb filter, BGP output, 3rd lock protector of 3.58MHz OSC
4. LPF usable for REC/PB
5. Capable of being operated from 5V supply
6. Current dissipation: 48mA at REC mode  
50mA at PB mode

**Maximum Ratings at Ta = 25°C**

Maximum Supply Voltage	V <sub>CC max</sub>			7.0	V
Allowable Power Dissipation	P <sub>d max</sub>	Ta ≤ 65°C	LA7316A-N	400	mW
			LA7316AM	330	mW
Operating Temperature	T <sub>opr</sub>			-10 to +65	°C
Storage Temperature	T <sub>stg</sub>			-40 to +125	°C

**Operating Conditions at Ta = 25°C**

Recommended Supply Voltage	V <sub>CC</sub>	5.2	V
Operating Voltage Range	V <sub>CC op</sub>	4.8 to 5.5	V

**Package Dimensions 1SIC**

(unit: mm)

3067

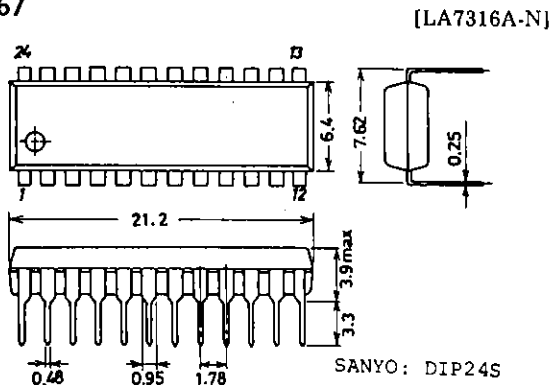

**Package Dimensions**

(unit: mm)

3112

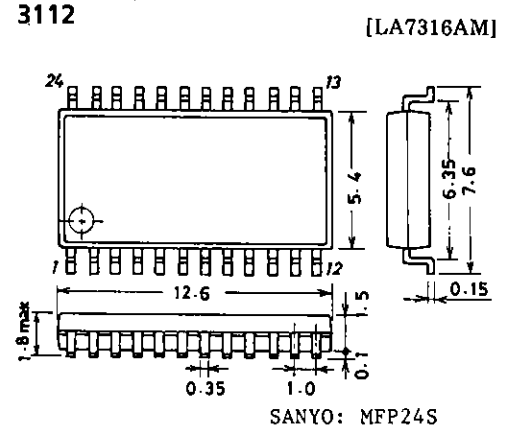

# LA7316A-N, LA7316AM

Operating Characteristics at  $T_a = 25^\circ\text{C}$ ,  $V_{CC} = 5.0\text{V}$

		min	typ	max	unit
REC Current Dissipation	$I_{CC(R)}$	38	48	58	mA
REC Output Level	$V_{O(R)}$	210	300	390	mVpp
REC ACC Characteristics	$\Delta V_{O(R)}$ Input $\pm 6\text{dB}$	-0.5	0	+0.5	dB
ACC Killer Input Level	$V_{ACK}$	-28	-25	-22	dB
VXO Control Sensitivity	$S_{VXO}$	2.5	3.7	5.5	Hz/mV
VXO OSC Level	$V_{VXO(R)}$	0.65	0.85	1.00	Vpp
Subconverter Output Level	$V_{SUB}$	200	250	300	mVpp
BGP Delay Time	$t_D$		3.2		$\mu\text{s}$
BGP Width	$t_W$		4.8		$\mu\text{s}$
REC APC Pull-in Range	$\Delta f_{APC}$	$\pm 350$			Hz
REC AFC Pull-in Range	$\Delta f_{AFC}$	$\pm 1.0$			kHz
160f <sub>H</sub> VCO Control Sensitivity	$S_{VCO}$	0.42	0.60	0.78	kHz/mV
PB Current Dissipation	$I_{CC(P)}$	40	50	60	mA
PB Output Level	$V_{O(P)}$	575	660	760	mVpp
PB ACC Characteristic	$\Delta V_{O(P)}$ Input $\pm 6\text{dB}$	-0.5		+0.5	dB
PB Main Converter Carrier Leak	$CL(P)$ 4.21MHz component		-40	-33	dB
PB XO Output Level	$V_{XO(P)}$	520	650	800	mVpp
PB XO Free-running Frequency	$f_{XO(f)}$ Difference from 3579545Hz	-7	0	+7	Hz
2f <sub>SC</sub> Output Amplitude	$V_{2fsc}$	420	600	780	mVpp
Burst Emphasis Amount	$G_{BE}$	5.5	6.0	6.5	dB
Burst De-emphasis Amount	$G_{BD}$	-4.75	-4.5	-4.25	dB
Comb Amp Gain	$G_{COMB}$	11	13	15	dB



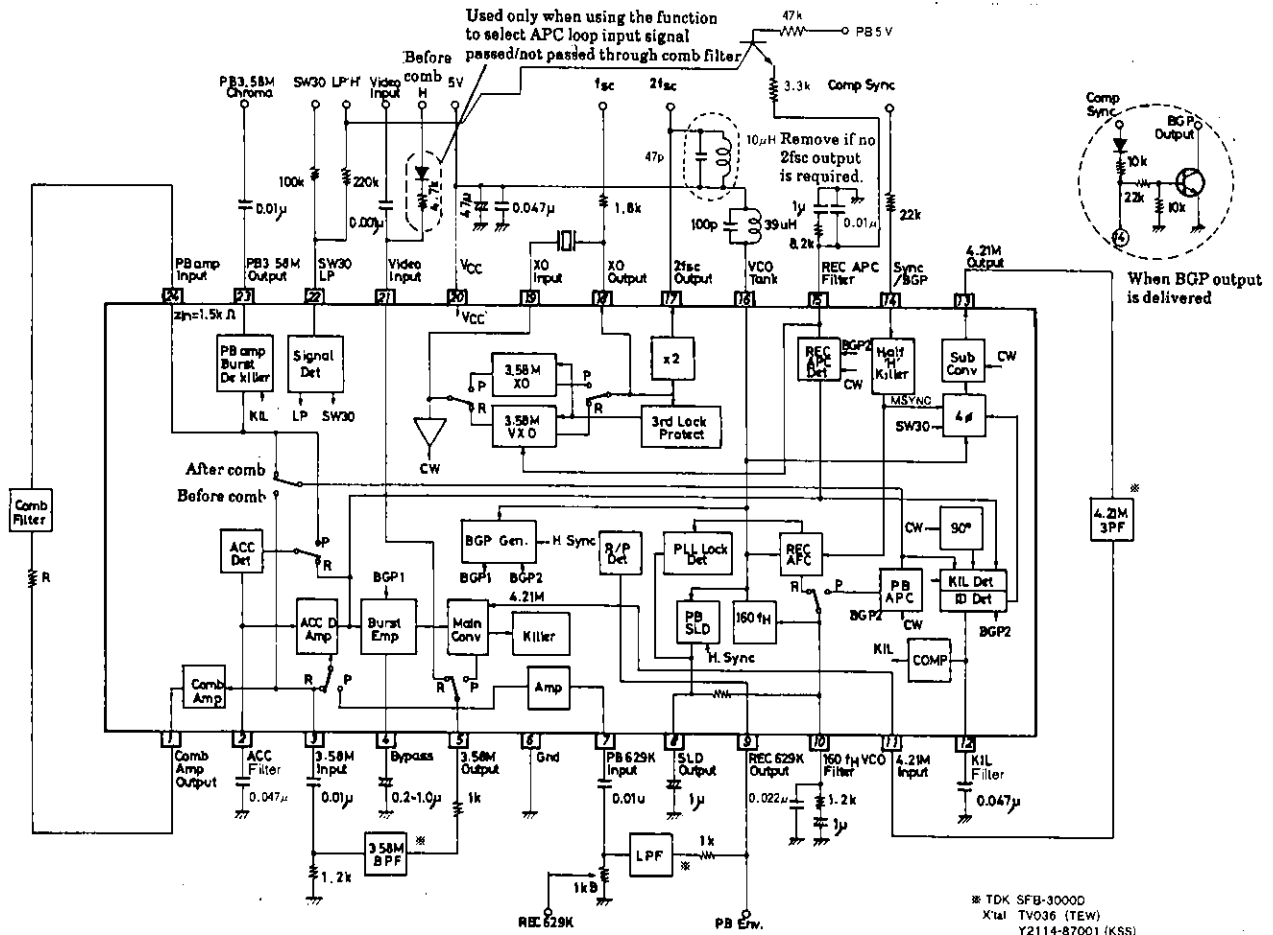

## Equivalent Circuit Block Diagram and Sample Peripheral Circuit

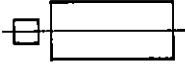
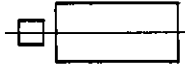

Unit (resistance:  $\Omega$ , capacitance: F)

LA7316A-N,LA7316AM

Pin Description

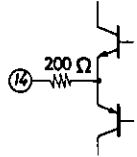
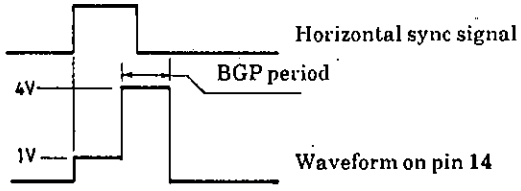
Pin No.	Function	Input/Output State	Remarks
1	COMB AMP OUT	E.F	Comb filter driver output 
2	ACC FILTER	Output 1kΩ	
3	3.58MHz IN	Input 10kΩ	3.58MHz BPF output is connected. 
4	BYPASS		Setting of DC bias of burst emphasis circuit 
5	3.58MHz OUT	E.F	REC mode : Video signal PB mode : Main converter output
6	GND		
7	PB 629kHz IN	Input 10kΩ	Signal is applied through LPF from PB preamp output at PB mode. 
8	SLD OUT		Compensation output is delivered when 160f <sub>H</sub> VCO frequency deviates from specified frequency.
9	REC 629kHz OUT	E.F	Main converter output at REC mode. When pin 9 voltage is raised to 2.2V or greater, PB mode is entered.
10	160f <sub>H</sub> VCO FILTER		REC mode : AFC referenced to horizontal sync signal PB mode : APC filter referenced to 3.58MHz OSC
11	4.21MHz IN	Input 1kΩ	Pin for inputting 4.21MHz for main converter. No matching resistor required. 
12	KIL FILTER		Color killer phase detector filter pin
13	4.21MHz OUT	Output 1kΩ	Subconverter output pin. Low spurious output because of operational type. No filter matching resistor required
14	SYNC IN/BGP OUT		Used for COMP, SYNC input/BGP output  

Continued on next page.

LA7316A-N,LA7316AM

Continued from preceding page.

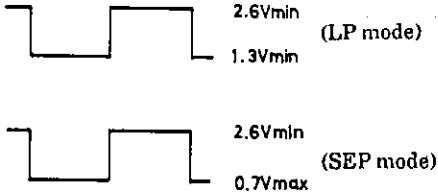
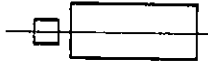
Pin No.	Function	Input/Output State	Remarks
15	REC APC FILTER SP-EP/LP (PB)		REC mode : REC APC detector filter pin PB mode : When the current flows in, LP mode is entered.
16	VCO TANK		Pin for external tank circuit for $160f_H$ VCO OSC
17	2fsc OUT		CCD drive clock 2fsc output pin. LC are connected for spurious output and stray capacitance compensation. If no 2fsc output is required, this pin is left open or connected to VCC.
18	XO OUT	E.F	Crystal OSC crystal drive output pin. Supplies fsc to servo circuit through resistor.  
19	XO IN	Input 1.5kΩ at REC mode 500Ω at PB mode	Signal which passed through crystal is applied. OSC is provided separately for REC/PB mode. No free-running frequency adjustment required at PB mode.
20	VCC		Power supply pin
21	VIDEO IN	Input/Output 15kΩ	Video signal is applied at REC mode. By pulling up to VCC using 4.7kΩ and diode, APC loop at PB mode can be supplied to phase detector from before comb filter.
22	SW30 IN SP-EP/LP (REC)	Base input	SW30 input. Threshold is set to $1/2V_{CC}$ . When lowest voltage of pulse drops to 0.7V or less, SEP mode is entered; and when raised to 1.3V or greater, LP mode is entered.  
23	PB 3.58MHz OUT	E.F	PB chroma output to be applied to YC-MIX circuit  
24	PB AMP IN	Input 1.5kΩ	Signal which passed through comb filter is applied.

- No products described or contained herein are intended for use in surgical implants, life-support systems, aerospace equipment, nuclear power control systems, vehicles, disaster/crime-prevention equipment and the like, the failure of which may directly or indirectly cause injury, death or property loss.
- Anyone purchasing any products described or contained herein for an above-mentioned use shall:
  - ① Accept full responsibility and indemnify and defend SANYO ELECTRIC CO., LTD., its affiliates, subsidiaries and distributors and all their officers and employees, jointly and severally, against any and all claims and litigation and all damages, cost and expenses associated with such use:
  - ② Not impose any responsibility for any fault or negligence which may be cited in any such claim or litigation on SANYO ELECTRIC CO., LTD., its affiliates, subsidiaries and distributors or any of their officers and employees jointly or severally.
- Information (including circuit diagrams and circuit parameters) herein is for example only; it is not guaranteed for volume production. SANYO believes information herein is accurate and reliable, but no guarantees are made or implied regarding its use or any infringements of intellectual property rights or other rights of third parties.