



SANYO Semiconductors

DATA SHEET

LA76818A

Monolithic Linear IC

**For PAL/NTSC Color Television Sets
VIF/SIF/Y/C/Deflection/CbCr
IN/EW Implemented in a
Single Chip**

Overview

The LA76818N is VIF/SIF/Y/C/Deflection/CbCr IN/EW Implemented in a Single Chip For PAL/NTSC Color Television Sets. The LA76818A is I²C bus controller ICs that support the different TV broadcast formats used worldwide and aim for rationalization of color Television set design, improved manufacturability, and lower total costs.

Features

- Single crystal multiformat system that supports the different TV broadcast formats used worldwide
Multiformat system : LA76818A (YCbCr support)
- Adjustment-free VIF/SIF, audio trap/audio bandpass filters
- Adjustment-free horizontal resonator system
- Simplified SG
- Supply voltage : $V_{CC} = 5V/9V$
- VIF/SIF
Adjustment-free VCO, 4-mode audio trap/audio bandpass filter, buzz canceller
RF AGC/video level
SIF system automatic discrimination (The LA7973 is used as the automatic discrimination IC.)
- Single crystal color system: PAL, NTSC, SECAM (The LA7642N is used as the SECAM decoder.)
- Black stretch, sharpness control with coring on/off control, built-in variable Y system filters
(Y-DL and chrominance trap)
- Chrominance bandpass filter, demodulation ratio and angle control

■ Any and all SANYO Semiconductor Co.,Ltd. products described or contained herein are, with regard to "standard application", intended for the use as general electronics equipment (home appliances, AV equipment, communication device, office equipment, industrial equipment etc.). The products mentioned herein shall not be intended for use for any "special application" (medical equipment whose purpose is to sustain life, aerospace instrument, nuclear control device, burning appliances, transportation machine, traffic signal system, safety equipment etc.) that shall require extremely high level of reliability and can directly threaten human lives in case of failure or malfunction of the product or may cause harm to human bodies, nor shall they grant any guarantee thereof. If you should intend to use our products for applications outside the standard applications of our customer who is considering such use and/or outside the scope of our intended standard applications, please consult with us prior to the intended use. If there is no consultation or inquiry before the intended use, our customer shall be solely responsible for the use.

■ Specifications of any and all SANYO Semiconductor Co.,Ltd. products described or contained herein stipulate the performance, characteristics, and functions of the described products in the independent state, and are not guarantees of the performance, characteristics, and functions of the described products as mounted in the customer's products or equipment. To verify symptoms and states that cannot be evaluated in an independent device, the customer should always evaluate and test devices mounted in the customer's products or equipment.

SANYO Semiconductor Co., Ltd.

TOKYO OFFICE Tokyo Bldg., 1-10, 1 Chome, Ueno, Taito-ku, TOKYO, 110-8534 JAPAN

Specifications

Maximum Ratings at $T_a = 25^\circ\text{C}$

Parameter	Symbol	Conditions	Ratings	Unit
Maximum supply voltage	V_8 max		7.0	V
	V_{31} max		7.0	V
	V_{43} max		7.0	V
Maximum supply current	I_{18} max		25	mA
	I_{25} max		35	mA
Allowable power dissipation	P_d max	$T_a \leq 65^\circ\text{C}^*$	1.6	W
Operating temperature	T_{opr}		-10 to +65	$^\circ\text{C}$
Storage temperature	T_{stg}		-55 to +150	$^\circ\text{C}$

* When mounted on a 114.3×76.1×1.6 mm³ glass epoxy board.

Operating Conditions at $T_a = 25^\circ\text{C}$

Parameter	Symbol	Conditions	Ratings	Unit
Recommended supply voltage	V_8		5.0	V
	V_{31}		5.0	V
	V_{43}		5.0	V
Recommended supply current	I_{18}		19	mA
	I_{25}		27	mA
Operating supply voltage range	V_8 op		4.7 to 5.3	V
	V_{31} op		4.7 to 5.3	V
	V_{43} op		4.7 to 5.3	V
Operating supply current range	I_{25} op		24 to 30	mA
	I_{18} op		17 to 21	mA

Electrical Characteristics $T_a = 25^\circ\text{C}$, $V_{CC L} = V_8 = V_{31} = V_{43} = 5.0\text{V}$, $I_{CC} = I_{18} = 19\text{mA}$, $I_{CC} = I_{25} = 27\text{mA}$

Parameter	Symbol	Conditions	Ratings			Unit
			min	typ	max	
Circuit voltage, current						
IF supply current	I_8	$V_8 = 5\text{V}$, $V_3 = 2.5\text{V}$	55.0	65.0	75.0	mA
RGB supply voltage	V_{18}	$I_{18} = 19\text{mA}$	7.8	8.2	8.5	V
Horizontal supply voltage	V_{25}	$I_{25} = 27\text{mA}$	4.8	5.1	5.4	V
CCD supply current	I_{31}	$I_{31} = 5\text{V}$		5.6		mA
Video supply current	I_{43}	$I_{43} = 5\text{V}$	125.0	140.0	155.0	mA
VIF block						
Maximum RFAGC voltage	VRFH	CW = 80dB μ , DAC = 0	8.5	9		Vdc
Minimum RFAGC voltage	VRFL	CW = 80dB μ , DAC = 63	0	0.3	0.7	Vdc
RF AGC Delay Pt	(@DAC = 0) RF _{AGC} ⁰ (@DAC = 63) RF _{AGC} ⁶³	DAC = 0 DAC = 63	90		80	dB μ
Input sensitivity	V_i	Output -3db			46	dB μ
No-signal video output voltage	V_{On}	No signal	3.4	3.7	4.0	Vdc
Sync signal tip level	V_{Otip}	CW = 80dB μ	1.1	1.4	1.7	Vdc
Video output amplitude	V_O	80dB μ , AM = 78%, fm = 15kHz	1.95	2.05	2.15	Vp-p
Video S/N	S/N	CW = 80dB μ	40	45		dB
C-S beat level	IC-S	V4.43MHz/V1.07MHz	35			dB
Differential gain	DG	80dB μ , 87.5% Video MOD		5.0	10.0	%
Differential phase	DP	80dB μ , 87.5% Video MOD		1.0	10.0	deg
Maximum AFT output voltage	V_{AFTH}	CW = 80dB μ , frequency variations	4.3	4.7	5	Vdc
Minimum AFT output voltage	V_{AFTL}	CW = 80dB μ , frequency variations	0.0	0.3	0.7	Vdc
AFT detection sensitivity	V_{AFTS}	CW = 80dB μ , frequency variations	8.0	15.0	22.0	mV/kHz
APC pull-in range (U)	fPU		1.0			MHz
APC pull-in range (L)	fPL		1.0			MHz

Continued on next page.

Continued from preceding page.

Parameter	Symbol	Conditions	Ratings			Unit	
			min	typ	max		
NT Trap1 (4.5MHz)	NTR1				-28	dB	
NT Trap2 (4.8MHz)	NTR2				-20	dB	
BG Trap1 (5.5MHz)	BTR1				-28	dB	
BG Trap2 (5.85MHz)	BTR2				-20	dB	
I Trap1 (6.0MHz)	ITR1				-28	dB	
I Trap2 (6.55MHz)	ITR2				-17	dB	
DK Trap1 (6.5MHz)	DTR1				-28	dB	
SIF block							
FM detection output voltage	SOADJ	FM = ± 30 kHz	220	310	435	mVrms	
FM limiting sensitivity	SLS	Output -3dB			53	dB μ	
FM detection output f characteristics	SF	fm = 100kHz	-0.5	5.0	8.0	dB	
FM detection output distortion	STHD	FM = ± 30 kHz			1.0	%	
AM rejection ratio	SAMR	AM = 30%	40			dB	
SIF S/N	SSN	DIN.Audio	50			dB	
PAL de-emph time constant	SPTC		2.4	3.0	3.6	dB	
PAL/NT difference of voltage gain	SGD		-1.5	0.0	+1.5	dB	
NT de-emph time constant	SNTC		1.9	2.5	3.1	dB	
AUDIO block							
Maximum gain	AGMAX	1kHz, 500mVrms	-2.0	0.5	+3.0	dB	
Variable range	ARANGE		60	74		dB	
Frequency characteristics	AF	20kHz	-3.0	0.0	3.0	dB	
Mute	AMUTE	20kHz	70			dB	
Distortion	ATHD	1kHz, 500mVrms, Vol: MAX			0.5	%	
S/N	ASN	DIN.Audio	65	73		dB	
Crosstalk	ACT	1kHz	70			dB	
Video block							
Video overall gain (Contrast max)	CONT127		10.0	12.0	14.0	dB	
Contrast adjustment Characteristics	Normal/max	CONT63	-7.5	-6.0	-4.5	dB	
	Min/max	CONT0	-15.0	-12.0	-9.0	dB	
Video frequency characteristics	NTSC	BW1	1.8MHz/100kHz Filter sys = 0000	-6.0	-3.0	0.0	dB
	PAL	BW2	2.2MHz/100kHz Filter sys = 0010	-6.0	-3.0	0.0	dB
	6MHz Trap	BW3	2.3MHz/100kHz Filter sys = 0100	-6.0	-3.0	0.0	dB
	APF	BW4	3.4MHz/100kHz Filter sys = 0000 Y APF=1	-6.0	-3.0	0.0	dB
Chroma trap amount	PAL	CtrapP		-36.0	-26.0	-22.0	dB
	NTSC	CtrapN		-36.0	-26.0	-22.0	dB
DC transmission amount	1	ClampG1	DCREST = 00	95.0	100.0	105.0	%
	2	ClampG2	DCREST = 01	102.0	107.0	112.0	%
	3	ClampG3	DCREST = 10	107.0	112.0	117.0	%
	4	ClampG4	DCREST = 11	123.0	128.0	133.0	%
Y-DL TIME	NTSC	TdY1	FILTER SYS = 0000	490.0	540.0	590.0	ns
	PAL	TdY2	FILTER SYS = 0010	530.0	580.0	630.0	ns
	SECAM	TDY3	FILTER SYS = 1000	610.0	660.0	710.0	ns
	6MHz Trap	TdY4	FILTER SYS = 0100	370.0	420.0	470.0	ns
	APF	TdY5	FILTER SYS = 0000, YAPF = 1	370.0	420.0	470.0	ns

Continued on next page.

Continued from preceding page.

Parameter		Symbol	Conditions	Ratings			Unit
				min	typ	max	
Black stretch gain	Max	BKSTmax	Gain = 10, Start = 01	27.0	32.0	37.0	IRE
	Mid	BKSTmid	Gain = 01, Start = 01	19.0	24.0	29.0	IRE
	Min	BKSTmin	Gain = 00, Start = 01	9.0	14.0	19.0	IRE
Black stretch start point	Max (60IRE ΔV)	BKSTTHmax	Bain = 01, Start = 10	-5.0	0.0	5.0	IRE
	Mid (50IRE ΔV)	BKSTTHmid	Bain = 01, Start = 01	-5.0	0.0	5.0	IRE
	Min (40IRE ΔV)	BKSTTHmin	Bain = 01, Start = 00	-5.0	0.0	5.0	IRE
Sharpness variability range NTSC	Trap 1 mid	Sharp31T1	F = 2.2MHz, FILTER SYS = 0000	5.0	8.0	11.0	dB
	Trap 1 max	Sharp63T1	F = 2.2MHz, FILTER SYS = 0000	9.0	12.0	15.0	dB
	Trap 1 min	Sharp0T1	F = 2.2MHz, FILTER SYS = 0000	-5.0	-2.0	1.0	dB
Sharpness variability range PAL	Trap 2 mid	Sharp32T2	F = 2.7MHz, FILTER SYS = 0010	5.0	8.0	11.0	dB
	Trap 2 max	Sharp63T2	F = 2.7MHz, FILTER SYS = 0010	8.5	11.5	13.5	dB
	Trap 2 min	Sharp0T2	F = 2.7MHz, FILTER SYS = 0010	-6.5	-3.5	-0.5	dB
Sharpness variability range SECAM	Trap 3 mid	Sharp32T3	F = 2.3MHz, FILTER SYS = 1000	5.0	8.0	11.0	dB
	Trap 3 max	Sharp63T3	F = 2.3MHz, FILTER SYS = 1000	8.5	11.5	13.5	dB
	Trap 3 min	Sharp0T3	F = 2.3MHz, FILTER SYS = 1000	-6.5	-3.5	-0.5	dB
Sharpness variability range 6MHz TRAP	Trap 4 mid	Sharp32T4	F = 3.0MHz, FILTER SYS = 0100	5.0	8.0	11.0	dB
	Trap 4 max	Sharp63T4	F = 3.0MHz, FILTER SYS = 0100	8.5	11.5	13.5	dB
	Trap 4 min	Sharp0T4	F = 3.0MHz, FILTER SYS = 0100	-6.5	-3.5	-0.5	dB
Sharpness variability range APF	Trap 5 mid	Sharp32T5	F = 3.0MHz, FILTER SYS = 0000 Y APF = 1	5.0	8.0	11.0	dB
	Trap 5 max	Sharp63T5	F = 3.0MHz, FILTER SYS = 0000 Y APF = 1	8.5	11.5	13.5	dB
	Trap 5 min	Sharp0T5	F = 3.0MHz, FILTER SYS = 0000 Y APF = 1	-6.5	-3.5	-0.5	dB
White peak limiter effective point	1	WPL1	APL = 100% WPL = 00	160.0	170.0	180.0	IRE
	2	WPL2	APL = 100% WPL = 01	130.0	140.0	150.0	IRE
	3	WPL3	APL = 100% WPL = 10	100.0	110.0	110.0	IRE
	4	WPL4	APL = 100% WPL = 11	70.0	80.0	90.0	IRE
Y gamma effective point	1	YG1	YGAMMA = 01	89.0	93.0	97.0	%
	2	YG2	YGAMMA = 10	85.0	89.0	93.0	%
	3	YG3	YGAMMA = 11	80.0	84.0	88.0	%
Gray Mode Level	GRAY	GLAY MODE = 1, CROSS B/W = 2	12.5	16.0	19.5	IRE	
Horizontal/vertical blanking output level	RGBBLK		0.1	0.4	0.7	V	
Pre-shoot adjust	1	PreShoot1	Pre-shoot adj. = 00	0.92	0.97	1.02	
	2	PreShoot2	Pre-shoot adj. = 11	1.08	1.13	1.18	
Over-shoot adjust	OverShoot	Over-shoot adj. = 11	1.08	1.13	1.18		
OSD block							
OSD Fast SW threshold	FSTH		0.7	0.9	1.1	V	
Red RGB output level	ROSDH		120	165	200	IRE	
Green RGB output level	GOSDH		70	120	140	IRE	
Blue RGB output level	BOSDH		85	120	155	IRE	
Analog OSD R output level	Gain match	RRGB	1.12	1.4	1.68	Ratio	
	Linearity	LRRGB	45	50	60	%	
Analog OSD G output level	Gain match	GRGB	0.8	1	1.2	Ratio	
	Linearity	LGRGB	45	50	60	%	
Analog OSD B output level	Gain Match	BRGB	0.8	1.0	1.2	Ratio	
	Linearity	LBRGB	45	50	60	%	

Continued on next page.

Continued from preceding page.

Parameter		Symbol	Conditions	Ratings			Unit
				min	typ	max	
RGB output (cutoff drive) block							
Brightness control	Normal	BRT63		1.9	2.2	2.5	V
	Normal-H	BRT63H		3.1	3.4	3.7	V
	Hi brightness Max	BRT127		20	25	30	IRE
	Low brightness Min	BRT0		-30	-25	-20	IRE
Cutoff control (min)	Vbias0		2.2	2.5	2.8	V	
(Bias control) (max)	Vbias255		3.1	3.4	3.7	V	
Resolution	Vbiassns			3.5		mV/Bit	
Sub-bias control Resolution	Vsbiassns			7		mV/Bit	
RB Drive adjustment Maximum output	RBout127			2.5		Vp-p	
G Drive adjustment Maximum output	Gout15			1.8		Vp-p	
RB Output attenuation	RBout0		7	9	11	DB	
G Output attenuation	Gout0		1.5	3.5	5.5	DB	
Video SW block							
Video signal input 1DC voltage	VIN1DC		2.2	2.5	2.8	V	
Video signal input 1AC voltage	VIN1AC			1		Vp-p	
Video signal input 2DC voltage	VIN2DC		2.2	2.5	2.8	V	
Video signal input 2AC voltage	VIN2AC			1		Vp-p	
SVO terminal DC voltage	SVODC		1.7	2	2.3	V	
SVO terminal AC voltage	SVOAC		1.7	2	2.3	Vp-p	
Chroma block (PAL/NTSC common)							
B-Y/Y amplitude ratio	CLRBY		75	100	150	%	
Color control characteristics 1	CLRMN	Color MAX/CEN	1.6	2.0	2.4	times	
Color control characteristics 2	CLRMM	Color MAX/MIN	33	40	50	dB	
Color control sensitivity	CLRSE		1	2	4	%/bit	
fsc output level	FSC22	a reference value		200			
Residual higher harmonic level B	E_CAR_B				300	mVp-p	
Residual higher harmonic level R	E_CAR_R				300	mVp-p	
Residual higher harmonic level G	E_CAR_G				300	mVp-p	
Chroma block (PAL)							
ACC amplitude characteristics 1	ACCM1_P	Input: +6dB/0dB 0dB = 40IRE	0.8	1.0	1.2	times	
ACC amplitude characteristics 2	ACCM2_P	Input: -20dB/0dB	0.7	1.0	1.1	times	
Demodulation output ratio R-Y/B-Y: PAL	RB_P	R-Y/B-Y_GainBalance_DAC, R-Y/B-Y_Angle_DAC = Center	0.50	0.56	0.67	times	
Demodulation output ratio G-Y/B-Y: PAL	GB_P	R-Y/B-Y_GainBalance_DAC, R-Y/B-Y_Angle_DAC = Center, R-Y = no-signal	-0.21	-0.19	-0.17	times	
Demodulation output ratio G-Y/R-Y: PAL	GR_P	R-Y/B-Y_GainBalance_DAC, R-Y/B-Y_Angle_DAC = Center, B-Y = no-signal	-0.56	-0.51	-0.46	times	
Demodulation angle R-Y/B-Y: PAL	ANGRB_P	R-Y/B-Y_GainBalance_DAC, R-Y/B-Y_Angle_DAC = Center	85	90	95	deg	
Killer operating point 0 (PAL)	KILLP0	0dB = 40IRE	-37		-25	dB	
Killer operating point 3 (PAL)	KILLP3	0dB = 40IRE	-40		-27	dB	
Difference between two Killer operating points (PAL)	DKILLP	KILLP0-KILLP3	0.5		6.0	dB	
APC pull-in range (+)	PULIN+_P		350			Hz	
APC pull-in range (-)	PULIN-_P				-350	Hz	

Continued on next page.

Continued from preceding page.

Parameter	Symbol	Conditions	Ratings			Unit	
			min	typ	max		
Chroma block (NTSC)							
ACC amplitude characteristics 1	ACCM1_N	Input:+6dB/0dB 0dB = 40IRE	0.8	1.0	1.2	times	
ACC amplitude characteristics 2	ACCM2_N	Input:-20dB/0dB	0.7	1.0	1.1	times	
Demodulation output ratio R-Y/B-Y: NTSC	RB_N	R-Y/B-Y_GainBalance_DAC, R-Y/B-Y_Angle_DAC = Center	0.80	0.90	1.00	times	
Demodulation output ratio G-Y/B-Y: NTSC	GB_N	R-Y/B-Y_GainBalance_DAC, R-Y/B-Y_Angle_DAC = Center	0.22	0.27	0.38	times	
Demodulation angle B-Y/R-Y: NTSC	ANGBR_N	R-Y/B-Y_GainBalance_DAC, R-Y/B-Y_Angle_DAC = Center	95	103	111	deg	
Demodulation angle G-Y/B-Y: NTSC	ANGGB_N	R-Y/B-Y_GainBalance_DAC, R-Y/B-Y_Angle_DAC = Center	227	237	247	deg	
Demodulation angle switch G-Y/B-Y: NTSC	ANGGC_N	G-Y Angle_DAC = 1	243	253	263	deg	
Killer operating point 0 (NTSC)	KILLN0	0dB = 40IRE	-39		-27	dB	
Killer operating point 3 (NTSC)	KILLN3	0dB = 40IRE	-40		-28	dB	
Difference between two Killer operating points (NTSC)	DKILLN	KILLN0-KILLN3	0.5		6	dB	
APC pull-in range (+)	PULIN+_N		350			Hz	
APC pull-in range (-)	PULIN-_N				-350	Hz	
Tint center	TINCEN		-10	0	10	deg	
Tint variable range (+)	TINT+				-40	deg	
Tint variable range (-)	TINT-		40			deg	
Cr Output amplitude	CBCR-R	CbCr_IN DAC = 1 Cross B/W = 1	1.7		3.4	Vp-p	
Cb Output amplitude	CBCR-B	CbCr_IN DAC = 1 Cross B/W = 1	1.8		3.7	Vp-p	
C-BPF1A (3.93MHz)	CBPF1A	Reference: 4.43MHz FILTER SYS = 0010	-5.0	-3.0	-1.0	dB	
C-BPF1B (4.73/4.13MHz)	CBPF1B	Reference: 4.13MHz FILTER SYS = 0010	-0.5	1.5	3.5	dB	
C-BPF1C (4.93/3.93MHz)	CBPF1C	Reference: 3.93MHz FILTER SYS = 0010	5.0	2.0	3.5	dB	
C-BPF2A (3.93MHz)	CBPF2A	Reference: 4.43MHz FILTER SYS = 0011	-5.0	-3.0	-1.0	dB	
C-BPF2B (4.73/4.13MHz)	CBPF2B	Reference: 4.13MHz FILTER SYS = 0011	-2.0	0.0	2.0	dB	
C-BPF2C (4.93/3.93MHz)	CBPF2C	Reference: 3.93MHz FILTER SYS = 0011	-2.5	0.0	2.5	dB	
Deflection block							
Horizontal free-running frequency	FH		15500	15670	15900	Hz	
Horizontal pull-in range	fH PULL		±400			Hz	
Horizontal output pulse width	Hduty		36.1	37.6	39.1	µs	
Horizontal output pulse saturation voltage	V Hsat		0	0.2	0.4	V	
Vertical free-running cycle 50	VFR50		312.0	312.5	313.0	H	
Vertical free-running cycle 60	VFR60		262.0	262.5	263.0	H	
Horizontal output pulse phase	HPHCENpal		9.5	10.5	11.5	µs	
Horizontal output pulse phase	HPHCENnt		9.5	10.5	11.5	µs	
Horizontal position adjustment range	HPHrange	5bit		±2.4		µs	
Horizontal position adjustment maximum variability width	HPHstep				350.0	ns	
Horizontal blinking	left @0	BLKL0	BLKL: 000	7500	8300	9100	ns
	left @7	BLKL7	BLKL: 111	10800	11600	12400	ns
	right @0	BLKR0	BLKR: 000	1800	2600	3400	ns
	right @7	BLKR7	BLKR: 111	-1100	-300	500	ns
Sand castle pulse crest value	H	SANDH		5.3	5.6	5.9	V
	M1	SANDM1		3.7	4.0	4.3	V
	M2	SANDM2		1.7	2.0	2.3	V
	L	SANDL		0.1	0.4	0.7	V

Continued on next page.

Continued from preceding page.

Parameter		Symbol	Conditions	Ratings			Unit
				min	typ	max	
Burst gate pulse	Width	BGPWD		2.5	3.0	3.5	μs
	Phase	BGPPH		4.9	5.4	5.9	μs
Horizontal output stop voltage		Hstop		3.30	3.60	3.90	V
Vertical screen size adjustment							
Vertical ramp output amplitude	PAL@64	Vspal64	VSIZE: 1000000	0.85	0.95	1.05	Vp-p
	NTSC@64	Vsnt64	VSIZE: 1000000	0.85	0.95	1.05	Vp-p
	PAL@0	Vspal0	VSIZE: 0000000	0.41	0.51	0.61	Vp-p
	NTSC@0	vsnt0	VSIZE: 0000000	0.41	0.51	0.61	Vp-p
	PAL@127	Vspal127	VSIZE: 1111111	1.15	1.30	1.45	Vp-p
	NTSC@127	Vsnt127	VSIZE: 1111111	1.15	1.30	1.45	Vp-p
High-voltage dependent vertical size correction							
Vertical size correction @0		Vsizecomp	VCOMP: 000	0.89	0.93	0.97	ratio
Vertical screen position adjustment							
Vertical ramp DC voltage	PAL@32	Vdcpal32	VDC: 100000	2.25	2.40	2.55	Vdc
	NTSC@32	Vdcnt32	VDC: 100000	2.25	2.40	2.55	Vdc
	PAL@0	Vdcpal0	VDC: 000000	1.85	2.00	2.15	Vdc
	NTSC@0	Vdcnt0	VDC: 000000	1.85	2.00	2.15	Vdc
	PAL@63	Vdcpal63	VDC: 111111	2.65	2.80	2.95	Vdc
	NTSC@63	Vdcnt63	VDC: 111111	2.65	2.80	2.95	Vdc
Vertical linearity	@16	Vlin16	VLIN: 10000	0.85	1.00	1.15	ratio
	@0	Vlin0	VLIN: 00000	1.17	1.32	1.47	ratio
	@31	Vlin31	VLIN: 11111	0.57	0.72	0.87	ratio
Vertical S-shaped correction	@16	Vscor16	VSC: 10000	0.75	0.90	1.05	ratio
	@0	Vscor0	VSC: 00000	1.08	1.23	1.38	ratio
	@31	Vscor31	VSC: 11111	0.49	0.64	0.79	ratio

Package Dimensions

unit : mm

3273

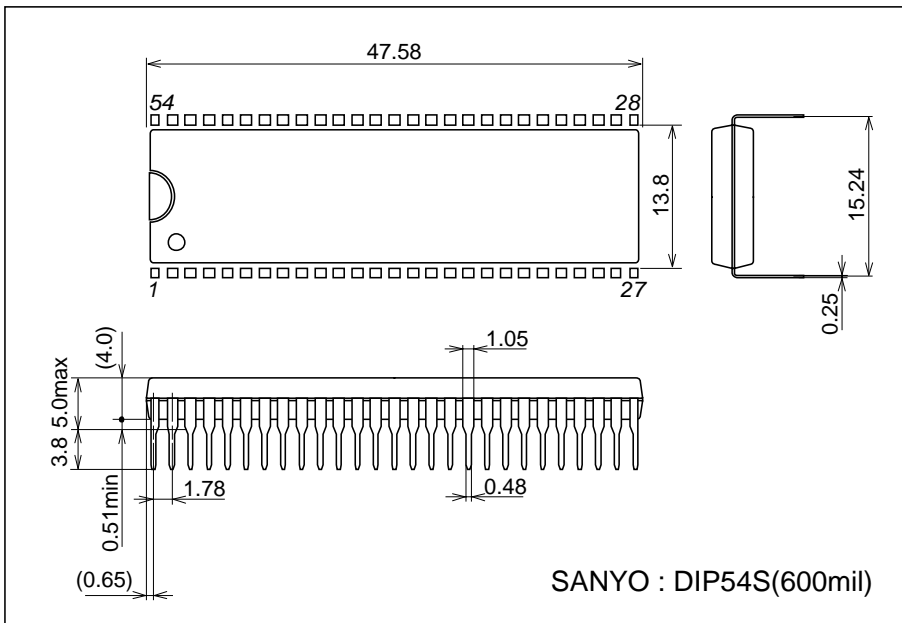



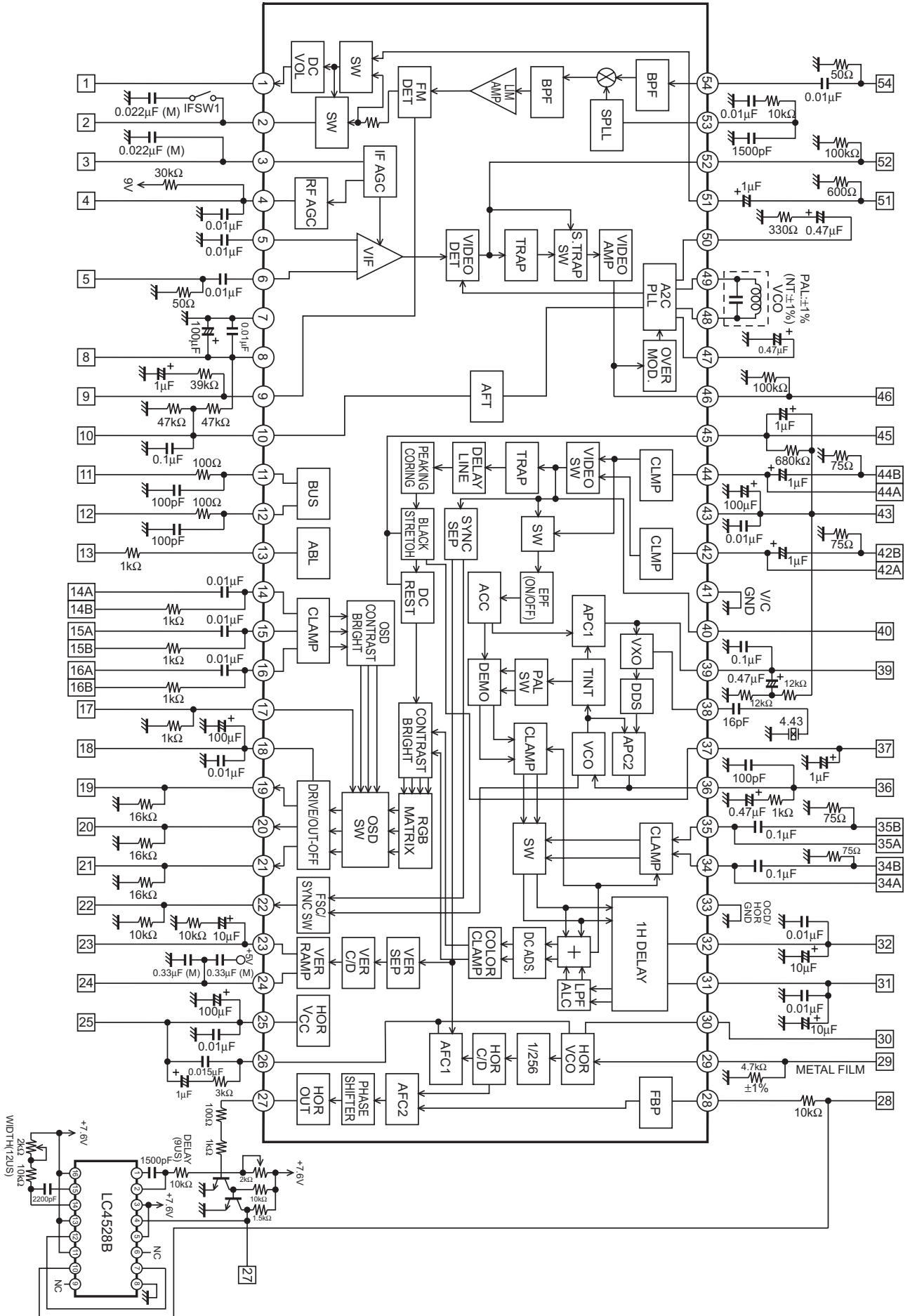

Block Diagram and Test Circuit









Test Conditions $T_a = 25^{\circ}\text{C}$, $V_{CC} = V_8 = V_{31} = V_{43} = 5.0\text{V}$, $I_{18} = 19\text{mA}$, $I_{CC} = I_{25} = 27\text{mA}$

Circuit Voltage, Current

Parameter	Symbol	Test point	Input signal	Test method	Bus conditions
Horizontal supply voltage	V_{25}		No signal	Apply a current of 27mA to pin 25 and measure the voltage at pin 25.	Initial
RGB supply voltage	V_{18}		No signal	Apply a current of 19mA to pin 18 and measure the voltage at pin 18.	Initial
IF supply current	I_8 ($CDDI_{CC}$)		No signal	Apply a voltage of 5.0V to pin 8 and measure the incoming DC current [mA]. (IF AGC 2.5V applied)	Initial
CCD supply current	I_{31}		No signal	Apply a voltage of 5.0V to pin 31 and measure the incoming DC current [mA].	Initial
Video/vertical supply current	I_{43}		No signal	Apply a voltage of 5.0V to pin 43 and measure the incoming DC current [mA].	Initial

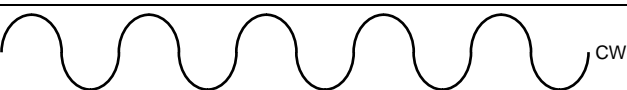
VIF Block Input Signals and Test Conditions

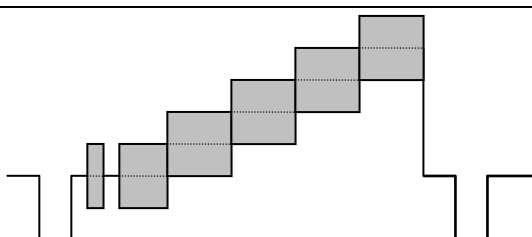
1. Input signals must all be input to the PIF IN (pin 6) in the Test Circuit.
2. All input signal voltage values are the levels at the VIF IN (pin 6) in the Test Circuit.
3. Signal contents and signal levels
4. Bus control condition: VIF SYS = "01", S.TRAP.SW = "1", OVER.MOD.SW = "0"

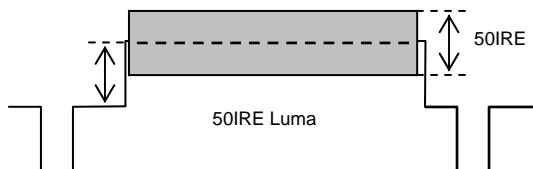
Input signal	Waveform	Conditions
SG1		38.9MHz
SG2		34.47MHz
SG3		33.4MHz
SG4		Frequency variable
SG5		38.9MHz 87.5% Video Mod. 10-stairstep wave (Subcarrier: 4.43MHz)
SG6		38.9MHz $f_m = 15\text{kHz}$, AM = 78%
SG7		38.9MHz, 80dB μ 87.5% Video Mod. 50IRE Luma (Carrier: variable)

5. Before measurement, adjust the DAC as follows.

Parameter	Test point	Input signal	Adjustment
Video Level DAC	46	SG6, 80dB μ	Set the output level at pin 46 as close to 2.0Vp-p as possible.

VIF Block Test Conditions

Input signal	Symbol	Test point	Input signal	Test method	Bus conditions
Maximum RF AGC voltage	VRFH	4	SG1 80dB μ	Measure the DC voltage at pin 4.	RF.AGC = "000000"
Minimum RF AGC voltage	VRFL	4	SG1 80dB μ	Measure the DC voltage at pin 4.	RF.AGC = "111111"
RF AGC Delay Pt	(@DAC = 0)	RFAGC0	SG1	Obtain the input level at which the DC voltage at pin 4 becomes 4.5V.	RF.AGC = "000000"
	(@DAC = 63)	RFAGC63		Obtain the input level at which the DC voltage at pin 4 becomes 4.5V.	RF.AGC = "111111"
Input sensitivity	Vi	46	SG6	Using an oscilloscope, observe the level at pin 46 and obtain the input level at which the waveform's p-p value becomes 1.4Vp-p.	
No-signal video output voltage	VOn	46	No signal	Set IF AGC = "1" and measure the DC voltage at pin 46.	
Sync signal tip level	VOtip	46	SG1 80dB μ	Measure the DC voltage at pin 46.	
Video output amplitude	VO	46	SG6 80dB μ	Using an oscilloscope, observe the level at pin 46 and measure the waveform's p-p value.	
Video S/N	S/N	46	SG1 80dB μ	Measure the noise voltage at pin 46 with an RMS voltmeter through a 10kHz to 5.0MHz band-pass filter. Vsn 20Log (1.43/Vsn).	
C-S beat level	IC-S	46	SG1 SG2 SG3	Input a 80dB μ SG1 signal and measure the DC voltage at pin 3. V3 Mix SG1 = 74dB μ , SG2 = 64dB μ , and SG3 = 64dB μ to enter the mixture in the VIF IN. Apply V3 to pin 3 from an external DC power supply. Using a spectrum analyzer, measure the difference between pin 46's 4.43MHz component and 1.07MHz component.	
Differential gain	DG	46	SG5 80dB μ	Using a vector scope, measure the level at pin 46.	
Differential phase	DP	46	SG5 80dB μ	Using a vector scope, measure the level at pin 46.	
Maximum AFT output voltage	VAFTH	10	SG4 80dB μ	Set and input the SG4 frequency to 37.9MHz to be input. Measure the DC voltage at pin 10 at that moment.	
Minimum AFT output voltage	VAFTL	10	SG4 80dB μ z	Set and input the SG4 frequency to 39.9MHz to be input. Measure the DC voltage at pin 10 at that moment.	
AFT detection sensitivity	VAFTS	10	SG4 80dB μ z	Adjust the SG4 frequency and measure frequency deviation Δf when the DC voltage at pin 10 changes from 1.5V to 3.5V. VAFTS = 2000/ Δf [mV/kHz]	

Continued on next page.

Continued from preceding page.

Input signal	Symbol	Test point	Input signal	Test method	Bus conditions
APC pull-in range (U), (L)	fPU, fPL	46	SG4 80dB μ	Connect an oscilloscope to pin 46 and adjust the SG4 frequency to a frequency higher than 38.9MHz to bring the PLL into unlocked mode. (A beat signal appears.) Lower the SG4 frequency and measure the frequency at which the PLL locks again. In the same manner, adjust the SG4 frequency to a lower frequency to bring the PLL into unlocked mode. Higher the SG4 frequency and measure the frequency at which the PLL locks again.	
NT Trap1 (4.5MHz), 2 (4.8MHz)	NTR1 NTR2	46	SG7	Determine the output level difference between carrier frequencies of 1MHz, 4.5MHz and 4.8MHz. (Reference: 1MHz)	SIF.SYS = "00"
BG Trap1 (5.5MHz), 2 (5.85MHz)	BTR1 BTR2	46	SG7	Determine the output level difference between carrier frequencies of 1MHz, 5.5MHz and 5.85MHz. (Reference: 1MHz)	SIF.SYS = "01"
I Trap1 (6.0MHz), 2 (6.55MHz)	ITR1 ITR2	46	SG7	Determine the output level difference between carrier frequencies of 1MHz, 6.0MHz and 6.55MHz. (Reference: 1MHz)	SIF.SYS = "10"
DK Trap1 (6.5MHz)	DTR1	46	SG7	Determine the output level difference between carrier frequencies of 1MHz and 6.5MHz. (Reference: 1MHz)	SIF.SYS = "11"

SIF Block (FM block) Input Signals and Test Conditions

Unless otherwise specified, the following conditions apply when each measurement is made.

1. Bus control condition:

IF.AGC.SW = "1", SIF.SYS = "01", DEEM-TC = "0", FM.GAIN = "0", A.MONI.SW = "0", A2.SW = "0"

2. IFSW1 = "ON", pin 29 = 5V

3. Input signals are input to pin 54 and the carrier frequency is 5.5MHz.

Parameter	Symbol	Test point	Input signal	Test method	Bus conditions
FM detection output voltage	S _O ADJ	2	90dB μ , fm = 400Hz, FM = \pm 30kHz	Measure the 400Hz component of the FM detection output at pin 2. SV1 [mVrms]	
FM limiting sensitivity	SLS	2	fm = 400Hz, FM = \pm 30kHz	Measure the input level (dB μ) at which the 400Hz component of the FM detection output at pin 2 becomes -3dB relative to SV1.	
FM detection output f characteristics (fm = 100kHz)	SF	2	90dB μ , fm = 100kHz FM = \pm 30kHz	Set SW: IF1 = "OFF". Measure the FM detection output of pin 2. SV2 [mVrms] SF = 20*Log (SV1/SV2) [dB]	
FM detection output distortion	STHD	2	90dB μ , fm = 400Hz, FM = \pm 30kHz	Measure the distortion factor of the 400Hz component of the FM detection output at pin 2.	
AM rejection ratio	SAMR	2	90dB μ , fm = 400Hz, AM = 30%	Measure the 400Hz component of the FM detection output at pin 2. SV3 [mVrms] Assign the measured value to SV3. SAMR = 20*Log (SV1/SV3) [dB]	
SIF.S/N	SSN	2	90dB μ , CW	Measure the noise level (DIN AUDIO.) at pin 2. SV4 [mVrms] SSN=20*Log (SV1/SV4) [dB]	
PAL de-emph time constant	SPTC	2	90dB μ , fm = 3.18kHz FM = \pm 30kHz	Measure the 3.18kHz component of the FM detection output at pin 2. SV5 [mVrms] SNTC = 20*Log (SV1/SV5) [dB]	
PAL/NT Difference of voltage gain	SGD	2	fo = 4.5MHz 90dB μ , fm = 400Hz FM = \pm 15kHz	Measure the 400Hz component of the FM detection output at pin 2. SV6 [mVrms] SNTC = 20*Log (SV1/SV6) [dB]	SIF.SYS = "00" DEEM-TC = "1" FM.GAIN = "1"
NT de-emph time constant	SNTC	2	fo = 4.5MHz 90dB μ , fm = 2.12kHz FM = \pm 15kHz	Measure the 2.12kHz component of the FM detection output at pin 2. SV7 [mVrms] SNTC = 20*Log (SV6/SV7) [dB]	SIF.SYS = "00" DEEM-TC = "1" FM.GAIN = "1"

Audio Block Input Signals and Test Conditions

Unless otherwise specified, the following conditions apply when each measurement is made.

1. Bus control condition:

AUDIO.MUTE = "0", A.MONI.SW = "0", AUDIO.SW = "1", VOL.FIL = "0", SIF.SYS = "01", IF.AGC.SW = "1"

2. Input 5.5MHz, 90dB μ and CW at pin 54.

3. Enter an input signal from pin 51.

Input signal	Symbol	Test point	Input signal	Test method	Bus conditions
Maximum gain	AGMAX	1	1kHz, CW 500mVrms	Measure the 1kHz component at the pin 1. V1 [mVrms] AGMAX = 20*Log (V1/500) [dB]	VOLUME = "1111111"
Variable range	ARANGE	1	1kHz, CW 500mVrms	Measure the 1kHz component the pin 1. V2 [mVrms] ARANGE = 20*Log (V1/V2) [dB]	VOLUME = "0000000"
Frequency characteristics	AF	1	20kHz, CW 500mVrms	Measure the 20kHz component at the pin 1. V3 [mVrms] AF = 20*Log (V3/V1) [dB]	VOLUME = "1111111"
Mute	AMUTE	1	20kHz, CW 500mVrms	Measure the 20kHz component at the pin 1. V4 [mVrms] AMUTE = 20*Log (V3/V4) [dB]	VOLUME = "1111111" AUDIO.MUTE = "1"
Distortion	ATHD	1	1kHz, CW 500mVrms	Measure the distortion of the 1kHz component at the pin 1.	VOLUME = "1111111"
S/N	ASN	1	No signal	Measure the noise level (DIN AUDIO) at the pin 1. V5 [mVrms] ASN = 20*Log (V1/V5) [dB]	VOLUME = "1111111"
Crosstalk	ACT	1	1kHz, CW 500mVrms	Measure the 1kHz component at the pin 1. V6 [mVrms] ACT = 20*Log (V1/V6) [dB]	VOLUME = "1111111" AUDIO.SW = "0"

Video Block Input Signals and Test Conditions

C IN Input* chroma burst signal: 40 IRE

Y IN input signal 100IRE: 714mV

Bus control bit conditions: Initial test state

0IRE signal (L-0): NTSC standard sync signal

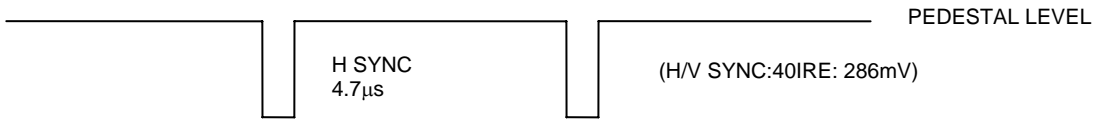

XIRE signal (L-X)

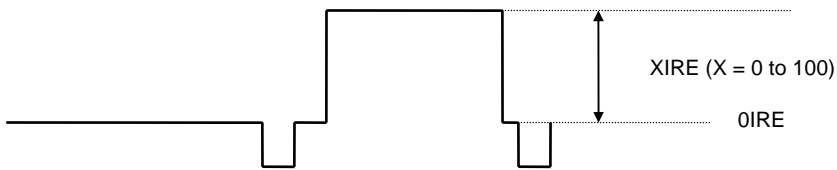

CW signal (L-CW)

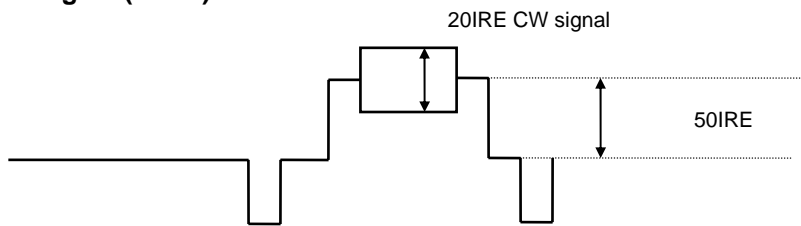

BLACK STRETCH 0IRE signal (L-BK)

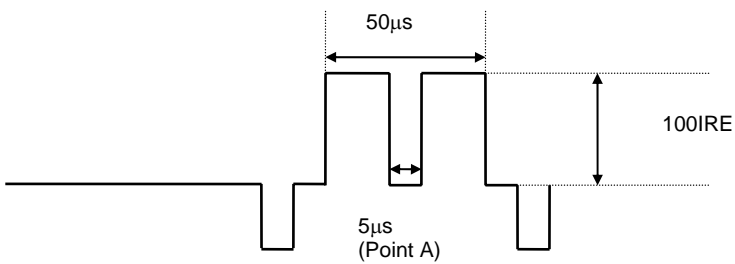

R/G/B IN Input signal

RGB Input signal 1 (0-1)

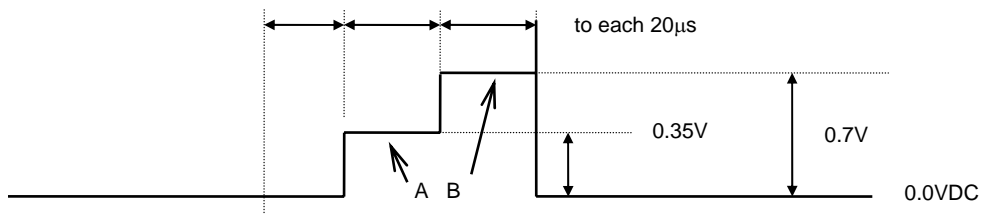

RGB Input signal 2 (0-2)

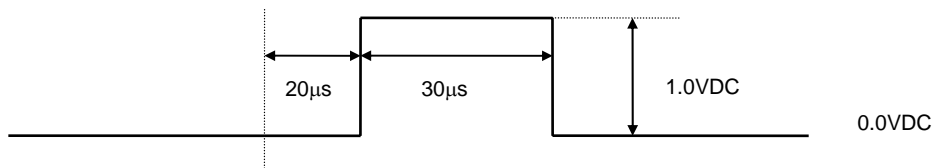

Video Block Test Conditions

Input signal		Symbol	Test point	Input signal	Test method	Bus conditions
Video overall gain (Contrast max)		CONT127	21	L-50	Measure the output signal's 50IRE amplitude. CNTHB [Vp-p] CONT127 = 20Log (CNTHB/0.357).	CONTRAST: 1111111
Contrast adjustment characteristics	Normal/max	CONT63	21	L-50	Measure the output signal's 50IRE amplitude. CNTCB [Vp-p] CONT63 = 20Log (CNTCB/0.357).	CONTRAST: 0111111
	Min/max	CONT0	21	L-50	Measure the output signal's 50IRE amplitude. CNTLB [Vp-p] CONT0 = 20Log (CNTLB/0.357).	CONTRAST: 0000000
Video frequency Characteristics	NTSC	BW1	21	L-CW	With the input signal's continuous wave = 100kHz, measure the output signal's continuous wave amplitude. PEAKDC [Vp-p] With the input signal's continuous wave = 1.8MHz, measure the output signal's continuous wave amplitude. CW1.8 [Vp-p] BW1 = 20Log (CW1.8/PEAKDC).	FILTER SYS: 0000 SHARPNESS: 000000
	PAL	BW2			With the input signal's continuous wave = 2.2MHz, measure the output signal's continuous wave amplitude. CW2.2 [Vp-p] BW2 = 20Log (CW2.2/PEAKDC).	FILTER SYS: 0010 SHARPNESS: 000000
	6MHz TRAP	BW3			With the input signal's continuous wave = 2.3MHz, measure the output signal's continuous wave amplitude. CW2.3 [Vp-p] BW3 = 20Log (CW2.3/PEAKDC).	FILTER SYS: 0100 SHARPNESS: 000000
	APF	BW4			With the input signal's continuous wave = 3.4MHz, measure the output signal's continuous wave amplitude. CW3.4 [Vp-p] BW3 = 20Log (CW3.4/PEAKDC).	FILTER SYS: 0000 SHARPNESS: 000000 Y APF: 1
Chroma trap amount	PAL	CtraPP	21	L-CW	With the input signal's continuous wave = 4.43MHz, measure the output signal's continuous wave amplitude. F0P [Vp-p] CtraP = 20Log (F0P/PEAKDC).	FILTER SYS: 010 Sharpness: 000000
	NTSC	CtraPN			With the input signal's continuous wave = 3.58MHz, measure the output signal's continuous wave amplitude. F0N [Vp-p] CtraN = 20Log (F0N/PEAKDC).	FILTER SYS: 000 Sharpness: 000000
DC transmission amount	1	ClampG1	21	L-0	Measure the output signal's 0IRE DC level. BRTPL [V]	Brightness: 0000000 CONTRAST: 1111111
				L-100	Measure the output signal's 0IRE DC level (DRVPH V) and 100IRE amplitude (DRVH Vp-p). ClampG = 100 × (1+(DRVPH - BRTPL)/DRVH). (PIN45: 3V)	Brightness: 0000000 Contrast: 1111111 DCREST=00 BLK.ST.DEF=1 WPL=0
				L-100	With DCREST = 01, carry out measurement similarly to the case of the DC transmission amount 1. (PIN45: 3V)	DC.rest. = 01
				L-100	With DCREST = 10, carry out measurement similarly to the case of the DC transmission amount 1. (PIN45: 3V)	DC.rest. = 10
	4	ClampG4	L-100	With DCREST = 11, carry out measurement similarly to the case of the DC transmission amount 1. (PIN45: 3V) Measure the output signal's 0IRE DC level (DRVPH V) and 100IRE amplitude (DRVH Vp-p) and calculate ClampG = 100 × (1+(DRVPH - BRTPL)/DRVH).	Brightness: 0000000 Contrast: 1111111	

Continued on next page.

Continued from preceding page.

Input signal		Symbol	Test point	Input signal	Test method	Bus conditions
Y-DL TIME	NTSC	TdY1	21	L-50	Obtain the time difference (the delay time) from when the rise of the input signal's 50IRE amplitude to the output signal's 50IRE amplitude.	FILTER SYS: 0100
	PAL	TdY2			Obtain the time difference (the delay time) from when the rise of the input signal's 50IRE amplitude to the output signal's 50IRE amplitude.	FILTER SYS: 0010
	SECAM	TdY3			Obtain the time difference (the delay time) from when the rise of the input signal's 50IRE amplitude to the output signal's 50IRE amplitude.	FILTER SYS: 1000
	6MHz TRAP	TdY4			Obtain the time difference (the delay time) from when the rise of the input signal's 50IRE amplitude to the output signal's 50IRE amplitude.	FILTER SYS: 0100
	APF	TdY5			Obtain the time difference (the delay time) from when the rise of the input signal's 50IRE amplitude to the output signal's 50IRE amplitude.	FILTER SYS: 0000 Y APF: 1
Black stretch gain	MAX	BKSTmax	21	L-BK	Measure the 0IRE DC level at point A of the output signal in the Black Stretch Defeat (Black Stretch OFF) mode. BKST1 [V] Measure the 0IRE DC level at point A of the output signal in the Black Stretch ON mode. (PIN45: 3V) BKST2 [V] BKSTmax = 50 × (BKST1-BKST2)/ CNTHB	Blk.str.gain = 10 Blk.str.start = 01
	MID	BKSTmid			With Blk.str.gain = 01, carry out the same measurement as for the case of black stretch gain (MAX). (PIN45: 3V)	Blk.str.gain = 01 Blk.str.start = 01
	MIN	BKSTmin			With Blk.str.gain = 00, carry out the same measurement as for the case of black stretch gain (max). (PIN45: 3V)	Blk.str.gain = 00 Blk.str.start = 01
Black stretch start max (60IRE ΔBlack)	BKSTTHmax	21	L-60	Measure the DC level at 60IRE of the output signal in the Black Stretch ON mode. (PIN45: 3V) BKST3 [V] Measure the 60IRE DC level of the output signal in the Black Stretch Defeat (Black Stretch OFF) mode. BKST4 [V] Calculate BKSTTHmax = 50 × (BKST4-BKST3)/ CNTHB.	Blk.str.gain = 01 Blk.str.start = 10	
Black stretch start mid (50IRE ΔBlack)	BKSTTHmid	21	L-50	Measure the 50IRE DC level of the output signal in the Black Stretch Defeat ON mode. (PIN45: 3V) BKST5 [V] Measure the 50IRE DC level of the output signal in the Black Stretch Defeat (Black Stretch OFF) mode. BKST6 [V] Calculate BKSTTHmid = 50 × (BKST6-BKST5)/ CNTHB.	Blk.str.gain = 01 Blk.str.start = 01	
Black stretch start min (40IRE ΔBlack)	BKSTTHmin	21	L-40	Measure the 40IRE DC level of the output signal in the Black Stretch Defeat ON mode. (PIN45: 3V) BKST7 [V] Measure the 40IRE DC level of the output signal in the Black Stretch Defeat (Black Stretch OFF) mode. BKST8 [V] Calculate BKSTTHmin = 50 × (BKST8-BKST7)/ CNTHB.	Blk.str.gain = 01 Blk.str.start = 00	

Continued on next page.

Continued from preceding page.

Input signal		Symbol	Test point	Input signal	Test method	Bus conditions
Sharpness variability range	NTSC	Sharp32T1	21	L-CW	With the input signal's continuous wave = 2.2MHz, measure the output signal's continuous wave amplitude. F01S32 [Vp-p] Sharp32T1 = 20Log (F01S32/PEAKDC)	FILTER SYS: 0000 Sharpness: 100000
	Max	Sharp63T1			With the input signal's continuous wave = 2.2MHz, measure the output signal's continuous wave amplitude. F01S63 [Vp-p] Sharp63T1 = 20Log (F01S63/PEAKDC)	FILTER SYS:0000 Sharpness: 111111
	Min	Sharp0T1			With the input signal's continuous wave = 2.2MHz, measure the output signal's continuous wave amplitude. F01S0 [Vp-p] Sharp0T1 = 20Log (F01S0/PEAKDC).	FILTER SYS: 0000 Sharpness: 000000
Sharpness variable range	PAL	Sharp32T2	21	L-CW	With the input signal's continuous wave = 2.7MHz, measure the output signal's continuous wave amplitude. F02S32 [Vp-p] Sharp32T3 = 20Log (F02S32/PEAKDC)	Filter Sys: 0010 Sharpness: 100000
	Max	Sharp63T2			With the input signal's continuous wave = 3MHz, measure the output signal's continuous wave amplitude. F02S63 [Vp-p] Sharp63T2 = 20Log (F02S63/PEAKDC)	Filter Sys: 0010 Sharpness: 111111
	Min	Sharp0T2			With the input signal's continuous wave = 3MHz, measure the output signal's continuous wave amplitude. F02S0 [Vp-p] Sharp0T2 = 20Log (F02S0/PEAKDC)	Filter Sys: 0010 Sharpness: 000000
Sharpness variable range	SECAM	Sharp32T3	21	L-CW	With the input signal's continuous wave = 2.3MHz, measure the output signal's continuous wave amplitude. F03S32 [Vp-p] Sharp32T3 = 20Log (F03S32/PEAKDC)	FILTER SYS: 1000 Sharpness: 100000
	Max	Sharp63T3			With the input signal's continuous wave=2.3MHz, measure the output signal's continuous wave amplitude. F03S63 [Vp-p] Sharp63T3 = 20Log (F03S63/PEAKDC)	FILTER SYS: 1000 Sharpness: 111111
	Min	Sharp0T3			With the input signal's continuous wave = 2.3MHz, measure the output signal's continuous wave amplitude. F01S0 [Vp-p] Sharp0T3 = 20Log (F03S0/PEAKDC)	FILTER SYS: 1000 Sharpness: 000000
Sharpness variable range	6MHz TRAP	Sharp32T4	21	L-CW	With the input signal's continuous wave = 3.0MHz, measure the output signal's continuous wave amplitude. F04S32 [Vp-p] Sharp32T4 = 20Log (F04S32/PEAKDC)	Filter Sys:0010 Sharpness: 100000
	Max	Sharp63T4			With the input signal's continuous wave = 3.0MHz, measure the output signal's continuous wave amplitude. F04S63 [Vp-p] Sharp63T2 = 20Log (F02S63/PEAKDC)	Filter Sys: 0010 Sharpness: 111111
	Min	Sharp0T4			With the input signal's continuous wave = 3.0MHz, measure the output signal's continuous wave amplitude. F04S0 [Vp-p] Sharp0T4 = 20Log (F04S0/PEAKDC)	Filter Sys: 0010 Sharpness: 000000

Continued on next page.

Continued from preceding page.

Input signal		Symbol	Test point	Input signal	Test method	Bus conditions
Sharpness variable range	APF	Sharp32T5	21	L-CW	With the input signal's continuous wave = 3.0MHz, measure the output signal's continuous wave amplitude. F05S32 [Vp-p] Sharp32T5 = 20Log (F05S32/PEAKDC)	FILTER SYS: 0000 Sharpness: 100000 Y APF: 1
	Max	Sharp63T5			With the input signal's continuous wave = 3.0MHz, measure the output signal's continuous wave amplitude. F05S63 [Vp-p] Sharp63T5 = 20Log (F05S63/PEAKDC)	FILTER SYS: 0000 Sharpness: 111111 Y APF: 1
	Min	Sharp0T5			With the input signal's continuous wave = 3.0MHz, measure the output signal's continuous wave amplitude. F05S0 [Vp-p] Sharp0T5 = 20Log (F05S0/PEAKDC).	FILTER SYS: 1000 Sharpness: 000000 Y APF:1
White peak limiter operating point	1	WPL1	21	L-100	Set WPL to 00, apply a 3.0 V level to pin 13, and measure the output amplitude (pedestal to white). Gradually increase the input signal amplitude and measure the output amplitude (pedestal to white) when the output clips (WP1). WPL1=WP1/CNTCB1*100	WPL = 00
	2	WPL2			Set WPL to 01, gradually increase the input signal amplitude and measure the output amplitude (pedestal to white) when the output clips (WP2). WPL2=WP2/CNTCB1*100	WPL = 01
	3	WPL3			Set WPL to 10, gradually increase the input signal amplitude and measure the output amplitude (pedestal to white) when the output clips (WP3). WPL3=WP3/CNTCB1*100	WPL = 10
	4	WPL4			Set WPL to 10, gradually increase the input signal amplitude and measure the output amplitude (pedestal to white) when the output clips (WP4). WPL4=WP4/CNTCB1*100	WPL = 10
Y gamma effective point	1	YG1	21	L-100	Measure the output amplitude (0 to 100 IR) when Y GAMMA is 0. After that, set Y GAMMA to 1 and measure the output amplitude (0 to 100 IR). This is GAM1. Calculate YG1 with the formula $YG1 = GAM1/GAM0 * 100$.	Y GAMMA = 1
	2	YG2	21		Measure the output amplitude (0 to 100 IR) when Y GAMMA is 0. After that, set Y GAMMA to 2 and measure the output amplitude (0 to 100 IR). This is GAM2. Calculate YG1 with the formula $YG2 = GAM2/GAM0 * 100$.	Y GAMMA = 2
	3	YG3	21		Measure the output amplitude (0 to 100 IR) when Y GAMMA is 0. After that, set Y GAMMA to 3 and measure the output amplitude (0 to 100 IR). This is GAM3. Calculate YG3 with the formula $YG3 = GAM3/GAM0 * 100$.	Y GAMMA = 3
GRAY MODE level	GRAY		21		Measure the DC level (deviation from pedestal) of pin21, and transfer IRE.	CROSS B/W:2 GRAY MODE:1
Horizontal/vertical blanking output level	RGBBLK		21	L-100	Measure the DC level (RGBBLK V) for the output signal's blanking period.	
Pre-shoot adjust1	PreShoot1		21	L-100	Measure the pre-shoot width (Tpre) and over-shoot width (Tover) at rise of 100IRE amplitude of the output signal. PreShoot = Tpre/Tover.	Pre-shoot adj. = 00 Filter Sys: 000 Sharpness = 111111
Pre-shoot adjust2	PreShoot2		21	L-100	With Pre-shoot adj. = 11, carry out the same measurement as for the case of Pre-Shoot 1.	Pre-shoot adj. = 11 Filter Sys: 000 Sharpness = 111111
Over-shoot adjust	OverShoot		21	L-100	With Over-shoot adj. = 11 Measure the pre-shoot width (Tpre) and over-shoot width (Tover) at rise of 100IRE amplitude of the output signal. OverShoot = Tover/Tpre.	Over-shoot adj. = 11 Filter Sys: 000 Sharpness = 111111

OSD Block Test Conditions

When measuring the OSD block, set the bus bit to 63(011111) for Contrast, 63(011111) for Brightness.

Input signal	Symbol	Test point	Input signal	Test method	Bus conditions
OSD Fast SW threshold	FSTH	21	L-0 O-2	Apply voltage to pin 17 and measure the voltage at pin 17 at the point where the output signal switches to the OSD signal.	Pin 16A: O-2 applied
Red RGB output level	ROSDC	19	L-50 L-0 O-2	Measure the output signal's 50IRE amplitude. CNTCR [Vp-p] Measure the OSD output amplitude. OSDHR [Vp-p] $ROSDC = 50 \times (OSDHR / CNTCR)$	Pin 17: 3.5V Pin 14A: O-2 applied
Green RGB output level	GOSDC	20	L-50 L-0 O-2	Measure the output signal's 50IRE amplitude. CNTCG [Vp-p] Measure the OSD output amplitude. OSDHG [Vp-p] $GOSDC = 50 \times (OSDHG / CNTCG)$	Pin 17: 3.5V Pin 15A: O-2 applied
Blue RGB output level	BOSDC	21	L-50 L-0 O-2	Measure the output signal's 50IRE amplitude. CNTCB [Vp-p] Measure the OSD output amplitude. OSDHB [Vp-p] $BOSDC = 50 \times (OSDHB / CNTCB)$	Pin 17: 3.5V Pin 16A: O-2 applied
Analog OSD R output level		19	L-0 O-1	Measure the amplitudes at point A (0.35V portion of the input signal 0-1) and point B (0.7V portion of the input signal 0-1) of the output signal. Assign the measured values to RGBLR Vp-p and RGBHR Vp-p, respectively.	Pin 17: 3.5V Pin 14A: O-1 applied
Gain match	RRGB			$RRGB = RGBLR / CNTCR.$	
linearity	LRRGB			$LRRGB = 100 \times (RGBLR / RGBHR).$	
Analog OSD G output level		20	L-0 O-1	Measure the amplitudes at point A (0.35V portion of the input signal 0-1) and point B (0.7V portion of the input signal 0-1) of the output signal. Assign the measured values to RGBLG Vp-p and RGBHG Vp-p, respectively.	Pin 17: 3.5V Pin 15A: O-1 applied
Gain match	GRGB			$GRGB = RGBLG / CNTCG.$	
linearity	LGRGB			$LGRGB = 100 \times (RGBLG / RGBHG).$	
Analog OSD B output level		21	L-0 O-1	Measure the amplitudes at point A (0.35V portion of the input signal 0-1) and point B (0.7V portion of the input signal 0-1) of the output signal. Assign the measured values to RGBLB Vp-p and RGBHB Vp-p, respectively.	Pin 17: 3.5V Pin 16A: O-1 applied
Gain match	BRGB			$BRGB = RGBLB / CNTCB.$	
linearity	LBRGB			$LBRGB = 100 \times (RGBLB / RGBHB).$	

RGB Output Block [Cutoff, Drive Block] Test Conditions

When measuring the RGB block, set the bus bit to 127(01111111) for Contrast.

Input signal	Symbol	Test point	Input signal	Test method	Bus conditions	
Brightness control	Normal	BRT63	L-0	Measure the 0IRE DC levels of the respective output signals of R output (19), G output (20), and B output (21). Assign the measured values to BRTPCR, BRTPCG, and BRTPCB V, respectively. $BRT63 = (BRTPCR + BRTPCG + BRTPCB) / 3$	Brightness: 01111111	
	normal-H	BRT63H			Measure the 0IRE DC level of the output signal of B output (21) and assign the measured value to BRTPCBH.	Brightness: 01111111 B Bias: 11111111 Sub Bias: 11111111
	Max	BRT127			Measure the 0IRE DC level of the output signal of B output (21) and assign the measured value to BRTPHB. $BRT127 = 50 \times (BRTPHB - BRTPCB) / CNTHB$	Brightness: 11111111 B Bias: 11111111 Sub Bias: 11111111
	Min	BRT0			Measure the 0IRE DC level of the output signal of B output (21) and assign the measured value to BRTPLB. $BRT0 = 50 \times (BRTPLB - BRTPCBH) / CNTHB$	Brightness: 00000000 B Bias: 11111111 Sub Bias: 11111111
Bias (cutoff) control	Min	Vbias0	L-50	Measure the 0IRE DC levels (Vbias0* V) of the respective output signals of R output (19), G output (20), and B output (21). *: R, G, and B	Sub-Brightness: 11111111	
	Max	Vbias255			Measure the 0IRE DC levels (Vbias255* V) of the respective output signals of R output (19), G output (20), and B output (21). *: R, G, and B	Sub-Brightness: 11111111 Red/Green/Blue Bias: 11111111
	resolution	Vbiasns			Measure the 0IRE DC levels (BAS80* V) of the respective output signals of R output (19), G output (20), and B output (21). *: R, G, and B Measure the 0IRE DC levels (BAS48* V) of the respective output signals of R output (19), G output (20), and B output (21). $Vbiasns^* = (BAS80^* - BAS48^*) / 32$	Red/Green/Blue Bias: 01010000 Sub Bias: 11111111 Red/Green/Blue Bias: 00110000 Sub Bias: 11111111
Sub-bias control resolution	Vsbiasns	19 20 21	L-50	Measure the 0IRE DC levels (SBTPM* V) of the respective output signals of R output (19), G output (20), and B output (21). $Vsbiasns^* = (BRTPC^* - SBTPM^*)$	Sub-Brightness: 0101010 Contrast: 01111111 Red/Green/Blue Bias: 11111111	

Continued on next page.

Continued from preceding page.

Input signal	Symbol	Test point	Input signal	Test method	Bus conditions
Drive adjustment maximum output	RBout127 Gout15	19 20 21	L-100	Measure the 100IRE amplitudes of the respective output signals of R output (19) and B output (21). DRVH* [Vp-p] *: R and B Measure the 100IRE amplitude of the output signal of G output (20) and assign the measured value to DRVH* [Vp-p]. *: G	Brightness: 0000000
Output attenuation	RBout0 Gout0	19 20 21	L-100	Measure the 100IRE amplitudes of the respective output signals of R output (19), G output (20), and B output (21). DRVL* [Vp-p] *: R and B Measure the 100IRE amplitude of the output signal of G output (20) and assign the measured value to DRVL* [Vp-p]. *: G RBout0* = 20Log (DRVH*/DRVL*) Gout0* = 20Log (DRVH*/DRVL*)	Brightness: 0000000 Red/Blue Drive: 0000000 Green Drive: 0000

VIDEO SW Block Test Conditions

Input signal	Symbol	Test point	Input signal	Test method	Bus conditions
Video signal input 1DC voltage	VIN1DC	42	L-100	Input signals to pin 42 and measure the voltage of the pedestal.	VIDEO SW: 1
Video signal input 1 AC voltage	VIN1AC	42		Pin 42 recommended input level	
Video signal input 2DC voltage	VIN2DC	44	L-100	Input signals to pin 44 and measure the voltage of the pedestal.	VIDEO SW: 0
Video signal input 2 AC voltage	VIN2AC	44		Pin 44 recommended input level	
SVO terminal DC voltage	SVODC	40	L-100	Input signals to pin 42 and measure the voltage of the pedestal at pin 40.	VIDEO SW: 1
SVO terminal AC voltage	SVOAC	40	L-100	Input signals to pin 42 and measure the voltage of the pedestal at pin 40.	VIDEO SW: 1

Chroma Block Input Signals and Test Conditions

Unless otherwise specified, the following conditions apply when each measurement is made.

1. VIF, SIF blocks: No signal
2. Deflection Block: Horizontal/vertical composite sync signals are input and the deflection block must be locked into the sync signals (Refer to the Deflection Block Input Signals and the Test Conditions).
3. Bus control conditions: Set the following conditions unless otherwise specified.
 - Y Input is 42 Pin (EXT-V IN),
 - C Input is 44 Pin (S-C IN)
 - (Video SW=1, C.Ext=1)
 Other DAC except the above-mentioned conditions is all initial conditions.
4. Y Input condition: No signal unless otherwise specified.
 - (Sync is necessary to obtain synchronization).
5. How to calculate the demodulation ratio and angle:

$$\text{B-Y axis angle} = \tan^{-1}(B(0)/B(270))+270^\circ$$

$$\text{R-Y axis angle} = \tan^{-1}(R(180)/R(90))+90^\circ$$

$$\text{G-Y axis angle} = \tan^{-1}(G(270)/G(180))+180^\circ$$

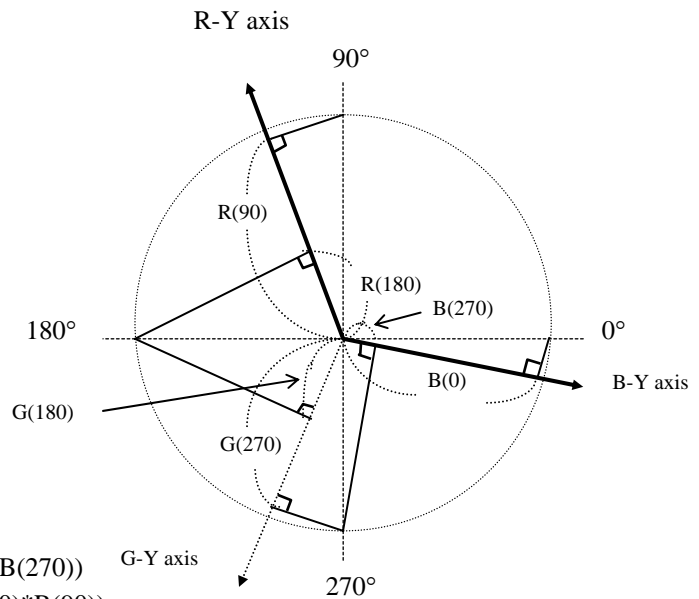

$$\text{B-Y axis amplitude } V_b = \text{SQRT}(B(0)*B(0)+B(270)*B(270))$$

$$\text{R-Y axis amplitude } V_r = \text{SQRT}(R(180)*R(180)+R(90)*R(90))$$

$$\text{G-Y axis amplitude } V_g = \text{SQRT}(G(180)*G(180)+G(270)*G(270))$$

6. Chroma input signal:

As for the PAL signal, the burst swings such as 135° and 225° every horizontal period.

Chroma describes the phase caused when the burst occurs at 135°.

As for the NTSC signal, the burst occurs constantly at 180°.

The figures below are based on the phase of NTSC. When a PAL signal is generated, adjust the phase and then enter signals.

The item common to both PAL and NTSC is the PAL signal. For those other than this, the measurement must be performed for each individual signals.

The condition of fsc: Set the following conditions unless otherwise specified.

PAL = 4.433619MHz

NTSC = 3.579545MHz

C-1

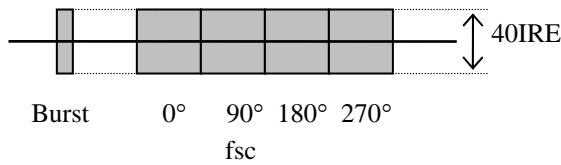

X IRE signal (L-X)

C-2

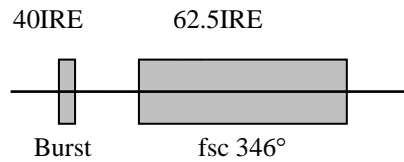

C-3

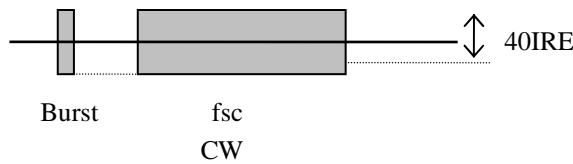

(Note: $fsc \pm N * fh$ when the frequency is specified.

N should be a natural number and the nearest value should be used.)

C-4

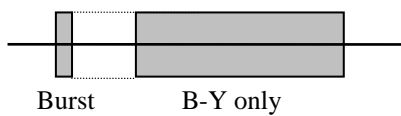

C-5

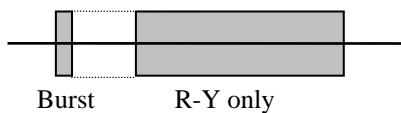

C-6

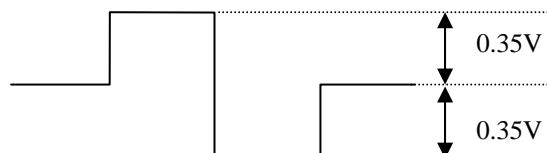

* There is no signal for H, V blanking period.

Chroma Block [PAL/NTSC Common] Test Conditions

Input signal	Symbol	Test point	Input signal	Test method	Bus conditions	
B-Y/Y amplitude ratio	CLRBY	Bout 21	YIN:L77 No signal	Measure the Y system's output level. V1		
			C-2	Input a signal to the CIN (only sync signal to the YIN) and measure the output level. CLRBY = $100 \times (V2/V1)+15\%$	Color: 1000000	
Color control characteristics	1	CLRMN	C-1	Measure the output amplitude V1 at color control MAX mode and output amplitude V2 at color control CEN mode. CLRMN = $V1/V2$	Color: 1111111 Color: 1000000	
	2	CLRMM		Measure the output amplitude V3 at color control MIN mode. V3 CLRMM = $20\text{Log}(V1/V3)$	Color: 0000000	
Color control sensitivity	CLRSE	21	C-1	Measure the output amplitude V4 at color control 90 mode and output amplitude V5 at color control 38 mode. CLRSE = $100 \times (V4-V5)/(V2 \times 52)$	Color: 1011010 Color: 0100110	
Residual higher harmonic level	B	E_CAR_B	C-1 Burst only	Measure the 8.86MHz component output amplitude at pin 21.		
	R	E_CAR_R		Rout 19	Measure the 8.86MHz component output amplitude at pin 19.	
	G	E_CAR_G		Gout 20	Measure the 8.86MHz component output amplitude at pin 20.	

Chroma Block [PAL] Test Conditions

Input signal	Symbol	Test point	Input signal	Test method	Bus conditions
ACC amplitude characteristics	1	ACCM1_P	C-1 0dB +6dB	Measure the output amplitude when 0dB is applied to the chroma input and the output amplitude when +6dB is applied to the chroma input and calculate the ratio between them. ACCM1_P = $20\text{Log}(+6\text{dBdata}/0\text{dBdata})$	Color: 1000000
	2	ACCM2_P		C-1 -20dB	Measure the output amplitude when -20dB is applied to the chroma input and calculate the ratio between them. ACCM2_P = $20\text{Log}(-20\text{dBdata}/0\text{dBdata})$
Demodulation output ratio R-Y/B-Y: PAL	RB_P	21 19	C-1	Refer to 5. and measure Bout output amplitude Vb and ROUT output amplitude Vr. RB_P = Vr/Vb .	Color: 1000000
Demodulation output ratio G-Y/B-Y: PAL	GB_P	21 20	C-4	Measure Bout output amplitude Vbp and GOUT output amplitude Vgpb. GB_P = $Vgpb/Vbp$.	Color: 1000000
Demodulation output ratio G-Y/R-Y: PAL	GR_P	20 19	C-5	Measure Rout output amplitude Vrp and GOUT output amplitude Vgpb. GR_P = $Vgrp/Vbp$.	Color: 1000000

Continued on next page.

Continued from preceding page.

Input signal	Symbol	Test point	Input signal	Test method	Bus conditions
Demodulation angle R-Y/B-Y: PAL	ANGBR_P	21 19	C-1	Refer to 5. and measure the B-Y and R-Y demodulation angle and calculate.	Color: 1000000
Killer operating point 0 (PAL)	KILLP0	21	C-1	Reduce the input signal until the output Level becomes 150mVp-p or less. Measure the input level at that moment.	Color Killer Ope.: 0
Killer operating point 3 (PAL)	KILLP3	21	C-1	Reduce the input signal until the output Level becomes 150mVp-p or less. Measure the input level at that moment.	Color Killer Ope.: 3
Difference between two Killer operating points (PAL)	DKILLP			DKILLP = KILLPO-KILLP3	
APC pull-in range (+)	PULIN+_P	21	C-1	Decrease the chroma fsc frequency from 4.433619MHz+1000Hz and measure the frequency at which the VCO locks.	
APC pull-in range (-)	PULIN-_P	21	C-1	Increase the chroma fsc frequency from 4.433619MHz-1000Hz and measure the frequency at which the VCO locks.	

Chroma Block [NTSC] Test Conditions

ACC amplitude characteristics	1	ACCM1_N	Bout 21	C-1 0dB +6dB	Measure the output amplitude when 0dB is applied to the chroma input And the output amplitude When +6dB is applied to the chroma input And calculate the ratio between them. $ACCM1_N = 20\text{Log} (+6\text{dBdata}/0\text{dBdata})$	
	2	ACCM2_N		C-1 -20dB	Measure the output amplitude when 20dB is applied to the chroma input and calculate the ratio between them. $ACCM2_N = 20\text{Log} (-20\text{dBdata}/0\text{dBdata})$	
Demodulation output ratio R-Y/B-Y: NTSC		RB_N	21 19	C-1	Refer to 5. and measure Bout output amplitude Vb and ROUT output amplitude Vr. And calculate $RB_N = Vr/Vb$.	Color: 1000000
Demodulation output ratio G-Y/B-Y: NTSC		GB_N	20	C-1	Refer to 5. and measure GOUT output amplitude Vg. And calculate $GB_N = Vg/Vb$.	Color: 1000000
Demodulation angle B-Y/R-Y: NTSC		ANGBR_N	21 19	C-1	Refer to 5. and measure the B-Y and R-Y demodulation angle and calculate. Reference: B-Y angle	Color: 1000000
Demodulation angle G-Y/B-Y: NTSC		ANGGB_N	21 20	C-1	Refer to 5. and measure the B-Y and G-Y demodulation angle and calculate. Reference: B-Y angle	Color: 1000000
Killer operating point 0 (NTSC)		KILLN0	21	C-1	Reduce the input signal until the output level becomes 150mVp-p or less. Measure the input level at that moment.	Color Killer Ope.: 0
Killer operating point 3 (NTSC)		KILLN3	21	C-1	Reduce the input signal until the output level becomes 150mVp-p or less. Measure the input level at that moment.	Color Killer Ope.: 3

Continued on next page.

Continued from preceding page.

Input signal	Symbol	Test point	Input signal	Test method	Bus conditions
Difference between two Killer operating points (NTSC)	DKILLN	21		DKILLN = KILLNO-KILLN3	
APC pull-in range (+)	PULIN+_N	21	C-1	Decrease the chroma fsc frequency from 3.579545MHz+1000Hz and measure the frequency at which the VCO locks.	
APC pull-in range (-)	PULIN-_N	21	C-1	Increase the chroma fsc frequency from 3.579545MHz-1000Hz and measure the frequency at which the VCO locks.	
Tint center	TINCEN	21	C-1	Measure each part of the output level and calculate the B-Y axis angle.	TINT: 1000000
Tint variable range (+)	TINT+	21	C-1	Measure each part of the output level and calculate the B-Y axis angle. TINT+ = B-Y axis angle -TINCEN	TINT: 1111111
Tint variable range (-)	TINT-	21	C-1	Measure each part of the output level and calculate the B-Y axis angle. TINT- = B-Y axis angle -TINCEN	TINT: 0000000
Cr output amplitude	CBCR-R	19	R-Y IN: C-6	Measure the output amplitude. (*B-Y IN: no signal)	CbCr IN: 1 Color System: 101 Cross B/W: 01
Cb output amplitude	CBCR-B	21	B-Y IN: C-6	Measure the output amplitude. (*R-Y IN: no signal)	CbCr IN: 1 Color System: 101 Cross B/W: 01

Filter Block Chroma BPF Characteristic

Input signal	Symbol	Test point	Input signal	Test method	Bus conditions
C-BPF1A Peaker amplitude characteristic 3.93MHz	CBPF1A	21	C-3 PAL signal	Set the chroma frequency (CW) to 4.433619MHz-100kHz and measure V0 output amplitude. And then, set the chroma frequency (CW) to 3.93MHz and measure V1 output amplitude. CBPF1A = 20Log (V1/V0)	FILTER SYS = 0010 C.BYPASS = 0
C-BPF1B Peaker amplitude characteristic 4.73/4.13MHz	CBPF1B	21	C-3 PAL signal	Measure V2 output amplitude when the chroma frequency (CW) is 4.13MHz and V3 output amplitude when it (CW) is 4.73MHz. CBPF1B = 20Log (V3/V2)	FILTER SYS = 0010 C.BYPASS = 0
C-BPF1C Peaker amplitude characteristic 4.93/3.93MHz	CBPF1C	21	C-3 PAL signal	Set the chroma frequency (CW) to 4.93MHz and measure V4 output amplitude. CBPF1C = 20Log (V4/V1)	FILTER SYS = 0010 C.BYPASS = 0
C-BPF2A BandPass amplitude characteristic 3.93MHz	CBPF2A	21	C-3 PAL signal	Set the chroma frequency (CW) to 4.433619MHz-100MHz and measure V00 output amplitude. And then, set the chroma frequency (CW) to 3.93MHz and measure V10 output amplitude. CBPF2A = 20Log (V10/V00)	FILTER SYS = 0011 C.BYPASS = 0
C-BPF2B BandPass amplitude characteristic 4.73/4.13MHz	CBPF2B	21	C-3 PAL signal	Measure V20 output amplitude when the chroma frequency (CW) is 4.13MHz and V30 output amplitude when it (CW) is 4.73MHz. CBPF2B = 20Log (V30/V20)	FILTER SYS = 0011 C.BYPASS = 0
C-BPF2C BandPass amplitude characteristic 4.93/3.93MHz	CBPF2C	21	C-3 PAL signal	Set the chroma frequency (CW) to 4.93MHz and measure V40 output amplitude. CBPF2C = 20Log (V40/V10)	FILTER SYS = 0011 C.BYPASS = 0

Deflection Block Input Signals and Test Conditions

Unless otherwise specified, the following conditions apply when each measurement is made.

1. VIF, SIF blocks: No signal
2. C input: No. signal
3. Sync input: A horizontal/vertical composite sync signal

PAL: 43IRE, horizontal sync signal (15.625kHz) and vertical sync signal (50kHz)

NTSC:40IRE, horizontal sync signal (15.734264kHz) and vertical sync signal (59.94kHz)

Note: No burst signal, chroma signal shall exist below the pedestal level.

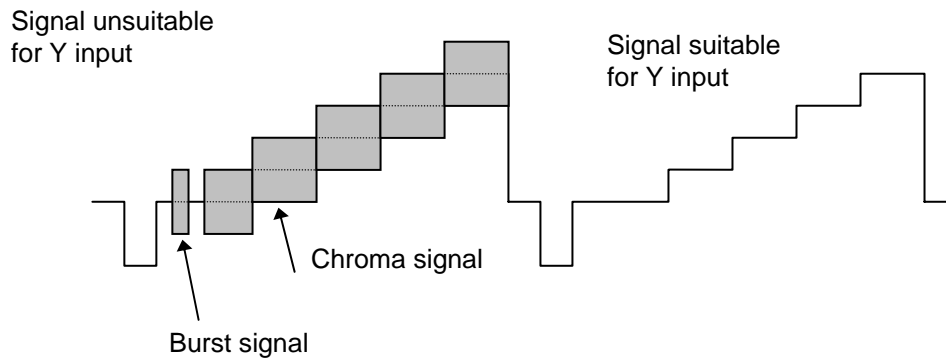

4. Bus control conditions: Initial conditions unless otherwise specified.
5. The delay time from the rise of the horizontal output (pin 27 output) to the fall of the FBP IN (pin 28 input) is 9 μ s.
6. Pin 13 (vertical size correction circuit input terminal) is connected to V_{CC} (5.0V).

Deflection Block Test Conditions

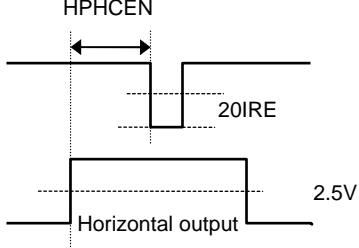
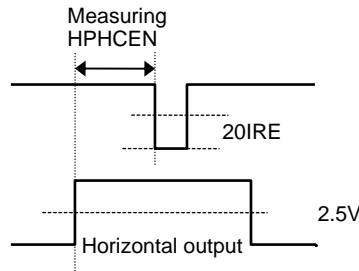
Input signal	Symbol	Test point	Input signal	Test method	Bus conditions
Horizontal free-running frequency	fH	27	Y IN: No signal	Connect a frequency counter to the output of pin 27 (H out) and measure the horizontal free-running frequency.	
Horizontal pull-in range	fH PULL	42	Y IN: Horizontal/ vertical sync signal PAL	Using an oscilloscope, monitor the horizontal sync signal which is input to the Y IN (pin 42) and the pin 27 output (H out) and vary the horizontal signal frequency to measure the pull-in range.	
Horizontal output pulse length	Hduty	27	Y IN: Horizontal/ vertical sync signal PAL	Measure the voltage for the pin 27 horizontal output pulse's low-level period.	
Horizontal output pulse saturation voltage	V Hsat	27	Y IN: Horizontal/ vertical sync signal PAL	Measure the voltage for the pin 27 horizontal output pulse's low-level period.	
Vertical free-running period	50 (PAL)	23	Y IN: No signal	Measure the vertical output period T at pin 23 T×15.625kHz (PAL) T×15.734kHz (NTSC)	CDMODE: 001 (PAL) CDMODE: 002 (NTSC)
	60 (NTSC)				
Horizontal output pulse	PAL	HPHCEN (PAL) (NTSC)	27 42	Y IN: Horizontal/ vertical sync signal PAL NTSC	Measure the delay time from to the rise of the pin 27 horizontal output pulse to the fall of the Y IN horizontal sync signal. 
	NTSC)				
Horizontal position adjustment range	HPHrange	27 42	Y IN: Horizontal/ vertical sync signal PAL	With H PHASE: 0 and 31, measure the delay time from the rise of the pin 27 horizontal output pulse to the fall of the Y IN horizontal sync signal and calculate the difference from H PHCEN. 	H PHASE: 00000 H PHASE: 11111

Continued on next page.

Continued from preceding page.

Input signal		Symbol	Test point	Input signal	Test method	Bus conditions
Horizontal position adjustment maximum variable width		HPHstep	<div style="border: 1px solid black; width: 20px; height: 20px; margin: 5px; display: flex; align-items: center; justify-content: center;">27</div> <div style="border: 1px solid black; width: 20px; height: 20px; margin: 5px; display: flex; align-items: center; justify-content: center;">42</div>	Y IN: Horizontal/ vertical sync signal PAL	<p>With H PHASE: 0 to 31 varied, measure the delay time from to the rise of the pin 27 horizontal output pulse to the fall of the Y IN horizontal sync signal and calculate the variation at each step. Retrieve data for maximum variation.</p>	H PHASE: 00000 to H PHASE: 11111
Horizontal blanking left variable range	@0	BLKL0	<div style="border: 1px solid black; width: 20px; height: 20px; margin: 5px; display: flex; align-items: center; justify-content: center;">27</div> <div style="border: 1px solid black; width: 20px; height: 20px; margin: 5px; display: flex; align-items: center; justify-content: center;">42</div>	Y IN: Horizontal/ vertical sync signal PAL	<p>Measure the time T from the left end of Hsync at pin 42 Y IN to the left end of blanking at pin 21 BlueOUT with BLKL = 000.</p>	BLKL: 000
	@7	BLKL7	<p>Measure the time T from the left end of Hsync at pin 42 Y IN to the left end of blanking at pin 21 BlueOUT with BLKL = 111.</p>		BLKL: 111	

Continued on next page.

Continued from preceding page.

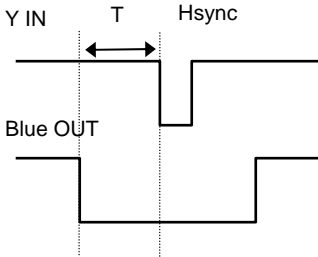
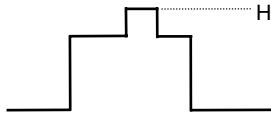
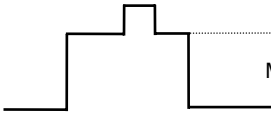
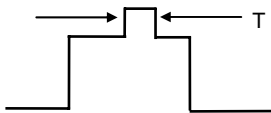
Input signal		Symbol	Test point	Input signal	Test method	Bus conditions
Horizontal blanking right variable range	@0	BLKR0	21 42	Y IN: Horizontal/ vertical sync signal PAL	Measure the time T from the left end of Hsync at pin 42 Y IN to the left end of blanking at pin 21 BlueOUT with BLKR = 000. 	BLKR: 000
	@7	BLKR7			Measure the time T from the left end of Hsync at pin 42 Y IN to the left end of blanking at pin 21 BlueOUT with BLKR = 111.	BLKR: 111
Sand castle pulse crest value	H	SANDH	28	Y IN: Horizontal/ vertical sync signal PAL	Measure the supply voltage at point H of the pin 28 FBP IN wave form for Hsync period. 	
	M1	SANDM1			Measure the supply voltage at point M1 of the pin 28 FBP IN wave form for Hsync period. 	
	L	SANDL			Measure the supply voltage at point L of the pin 28 FBP IN wave form for Hsync period.	
	M2	SANDM2			Measure the supply voltage at point M2 of the pin 28 FBP IN wave form for Vsync period.	
Burst gate pulse length	BGPWD		28	Y IN: Horizontal/ vertical sync signal PAL	Measure the BGP width T of the pin 28 FBP IN wave form for Hsync period. 	

Continued on next page.

Continued from preceding page.

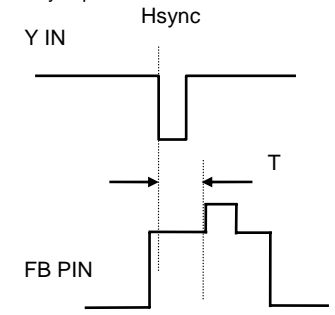
Input signal	Symbol	Test point	Input signal	Test method	Bus conditions
Burst gate pulse I phase	BGPPH	28 42	Y IN: Horizontal/ vertical sync signal PAL	Measure the time from the left end of Hsync at pin 42 Y IN to the left end of the pin 28 FBP IN wave form for Hsync period. 	
Horizontal output stop voltage	Hstop	25 47	Y IN: Horizontal/ vertical sync signal	Decrease the current from a source connected to pin 25 and measure the pin 25 voltage at which HOUT stops.	

Vertical screen size correction

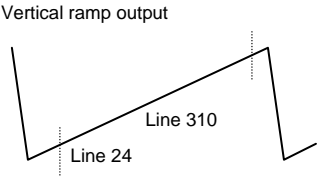
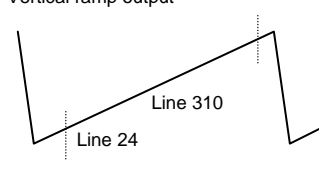
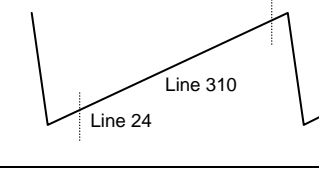
Input signal	Symbol	Test point	Input signal	Test method	Bus conditions
Vertical ramp output amplitude	PAL@64 Vspal64 Vsnt64	23	Y IN: Horizontal/ vertical sync signal PAL NTSC	Monitor the pin 23 vertical ramp output and measure the voltage at line 24 (22: NTSC) and line 310 (262: NTSC). $Vspal64 = Vline310 - Vline24$ $Vsnt64 = Vline262 - Vline22$ 	
	NTSC@64				
Vertical ramp output amplitude	PAL@0 Vspal0 Vsnt0	23	Y IN: Horizontal/ vertical sync signal PAL NTSC	Monitor the pin 23 vertical ramp output and measure the voltage at line 24 (22: NTSC) and line 310 (262: NTSC). $Vspal0 = Vline310 - Vline24$ $Vsnt0 = Vline262 - Vline22$ 	VSIZ: 0000000
	NTSC@0				
Vertical ramp output amplitude	PAL@127 Vspal127 Vsnt127	23	Y IN: Horizontal/ vertical sync signal PAL NTSC	Monitor the pin 23 vertical ramp output and measure the voltage at line 24 (22: NTSC) and line 310 (262: NTSC). $Vspal127 = Vline310 - Vline24$ $Vsnt127 = Vline262 - Vline22$ 	VSIZ: 1111111
	NTSC@127				

High-voltage dependent vertical size correction

Input signal	Symbol	Test point	Input signal	Test method	Bus conditions
Vertical size correction@0	Vsizecomp	23	Y IN: Horizontal/ vertical sync signal PAL	Monitor the pin 23 vertical ramp output and measure the voltage at the line 24 and line 310 with VCOMP = 000. $V_a = V_{line310} - V_{line24}$ Apply 4.1V to pin 13 and measure the voltage at the line 24 and line 310 again. Calculate as follows: $V_a = V_{line310} - V_{line24}$ $V_{sizecomp} = V_b / V_a$	VCOMP: 000

Vertical Screen Position Adjustment

Input signal	Symbol	Test point	Input signal	Test method	Bus conditions
Vertical ramp DC voltage	PAL@32	23	Y IN: Horizontal/ vertical sync signal PAL NTSC	Monitor the pin 23 vertical ramp output and measure the voltage at line 167. (PAL) Monitor the pin 23 vertical ramp output and measure the voltage at line 142. (NTSC)	
	NTSC@32				
Vertical ramp DC voltage	PAL@0	23	Y IN: Horizontal/ vertical sync signal PAL NTSC	Monitor the pin 23 vertical ramp output and measure the voltage at line 167. (PAL) Monitor the pin 23 vertical ramp output and measure the voltage at line 142. (NTSC)	VDC: 000000
	NTSC@0				
Vertical ramp DC voltage	PAL@63	23	Y IN: Horizontal/ vertical sync signal PAL NTSC	Monitor the pin 23 vertical ramp output and measure the voltage at line 167. (PAL) Monitor the pin 23 vertical ramp output and measure the voltage at line 142. (NTSC)	VDC: 111111
	NTSC@63				

Continued on next page.

Continued from preceding page.

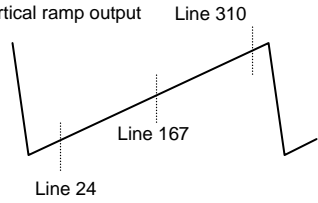
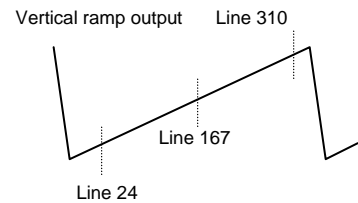
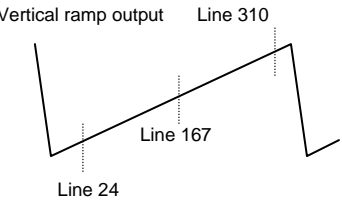
Input signal		Symbol	Test point	Input signal	Test method	Bus conditions
Vertical linearity	@16	Vlin16	23	Y IN: Horizontal/ vertical sync signal PAL	Monitor the pin 23 vertical ramp output and measure the voltage at line 24, line 167 and 310. Assign the respective measured values to Va, Vb and Vc. $Vlin16 = (Vb - Va) / (Vc - Vb)$ 	
	@0	Vlin0			Monitor the pin 23 vertical ramp output and measure the voltage at line 24, line 167 and 310. Assign the respective measured values to Va, Vb and Vc. $Vlin0 = (Vb - Va) / (Vc - Vb)$ 	VLIN: 00000
	@31	Vlin31				Monitor the pin 23 vertical ramp output and measure the voltage at line 24, line 167 and 310. Assign the respective measured values to Va, Vb and Vc. $Vlin31 = (Vb - Va) / (Vc - Vb)$ 

Continued on next page.

Continued from preceding page.

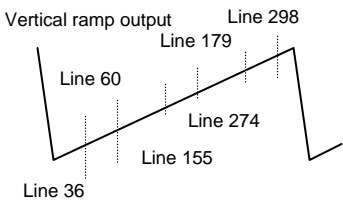
Input signal		Symbol	Test point	Input signal	Test method	Bus conditions
Vertical S-shaped correction	@16	VScor16	15	Y IN: Horizontal/ vertical sync signal PAL	Monitor the pin 23 vertical ramp output and measure the voltage at line 36, line 60, line 155, line 179, line 274 and 298. Assign the respective measured values to Va, Vb, Vc, Vd, Ve and Vf. $VScor16 = 0.5((Vb-Va)+(Vf-Ve))/(Vd-Vc)$ 	VS: 10000
	@0	VScor0			Monitor the pin 23 vertical ramp output and measure the voltage at the line 36, line 60, line 155, line 179, line 274 and line 298 with VSC = 00000. Assign the respective measured values to Va, Vb, Vc, Vd, Ve and Vf. $VScor0 = 0.5((Vb-Va)+(Vf-Ve))/(Vd-Vc)$	
	@31	VScor31			Monitor the pin 23 vertical ramp output and measure the voltage at line 36, line 60, line 155, line 179, line 274 and 298 with VSC = 11111. Assign the respective measured values to Va, Vb, Vc, Vd, Ve and Vf. $Vscor31 = 0.5((Vb-Va)+(Vf-Ve))/(Vd-Vc)$	VSC: 11111

Control Register Bit Allocation Map

Sub Address	MSB		DATA BITS					LSB	
	DA0	DA1	DA2	DA3	DA4	DA5	DA6	DA7	
00000000	T.Disable	AFC gain&gate	H.FREQ						
	1	0	1	1	1	1	1	1	
00001	Vest Timing	Audio.Mute	Video.Mute	H.PAHSE					
	0	0	0	1	0	0	0	0	
00010	Sync.Kill	V.SIZE							
	0	1	0	0	0	0	0	0	
00011	VSEPUP	V.KILL	V.POSI						
	0	0	1	0	0	0	0	0	
00100	H BLK L		V.LIN						
	1	0	0	1	0	0	0	0	
00101	H BLK R		V.SC						
	1	0	0	0	0	0	0	0	
00110	V.TEST	V.COMP	COUNT.DOWN.MODE						
	0	0	1	1	1	0	0	0	
00111	R.BIAS								
	0	0	0	0	0	0	0	0	
01000	G.BIAS								
	0	0	0	0	0	0	0	0	
01001	B.BIAS								
	0	0	0	0	0	0	0	0	
01010	RGB.Test4	R.DRIVE							
	0	1	1	1	1	1	1	1	
01011	Drive.Test	Half tone	Half tone Def	G.DRIVE					
	0	0	1	1	1	0	0	0	
01100	A2.SW	B.DRIVE							
	0	1	1	1	1	1	1	1	
01101	Blank.Def	Sub.Bright							
	0	1	0	0	0	0	0	0	
01110	A.MONI.SW	Bright							
	0	1	0	0	0	0	0	0	
01111	S.TRAP.SW	Contrast							
	1	1	0	0	0	0	0	0	
10000	OSD Cnt.Test	OSD Contrast							
	0	1	0	0	0	0	0	0	
10001	Coring Gain (W/Defeat)	Sharpness							
	0	0	0	0	0	0	0	0	
10010	Tint.Test	Tint							
	0	1	0	0	0	0	0	0	
10011	Color.Test	Color							
	0	1	0	0	0	0	0	0	
10100	Video SW	Trap.Test	Filter.Sys						
	0	1	0	0	0	1	0	0	
10101	Gray Mode	Cross B/W	CbCr_IN	G-Y Angle	Color killer ope.				
	0	0	0	0	0	0	0	0	
10110	VBLK SW	FBPBLK.SW	For or Csync	Y_APF	Pre/Over-shoot adj.	WPL Ope. Point (W/Defeat)			
	0	1	0	0	0	0	0	0	
10111	Y Gamma Start	DC.Rest	Blk.Str.start (W/Defeat)	Blk.Str.Gain					
	0	0	0	0	0	0	0	0	

Continued on next page.

Continued from preceding page.

Sub Address	MSB				DATA BITS			LSB
	DA0	DA1	DA2	DA3	DA4	DA5	DA6	DA7
00011000	Auto.Flesh 0	C.Ext 0	C.Bypass 1	C_Kill ON 0	C_Kill OFF 0	Color.Sys		
						0	0	0
11001	Cont.Test 0	Digital OSD 0	Brт.Abl.Def 0	Mid.Stp.Def 0	RGB Temp SW 0	Bright.Abl.Threshold		
						1	0	0
11010	R-Y/B-Y Gain Balance				R-Y/B-Y Angle			
	1	0	0	0	1	0	0	0
11011	B-Y DC Level (White-Balance)				R-Y DC Level (White-Balance)			
	1	0	0	0	1	0	0	0
11100	Audio SW 0	Volume						
		0	0	0	0	0	0	0
11101	OVER.MOD.SW 0	VOL.FIL 0	RF.AGC					
			1	0	0	0	0	0
11110	FM.Mute 0	deem.TC 0	VIF.Sys.SW		SIF.Sys.SW		FM.Gain	IF.AGC
			0	1	0	1	0	0
11111	VIDEO.LEVEL			FM.LEVEL				
	1	0	0	1	0	0	0	0
100000	Pre/Over SW 0	C.VCO Adj SW 0	*	*	*	*	*	*
100001	C.VCO Adjust		*	*	*	*	*	*
	0	0	0	0	0	0	0	
100010	*	Tint.Tthrough	*	*	*	*	*	*
	(0)	0	0	0	0	0	0	0
100011	*	*	*	*	*	*	*	*
	0	0	0	0	0	0	0	0
100100	*	Hlock.Vdet	*	*	*	*	*	*
	0	0	0	0	0	0	0	0
100101	VIDEO.LEVEL.OFFSET		IF.TEST1	*	OVER.MOD.LEVEL			
	0	1	0	(0)	1	0	0	0

Status Register Bit Allocations

	MSB				DATA BITS			LSB
	DA0	DA1	DA2	DA3	DA4	DA5	DA6	DA7
Status1	*	*	*	RF.AGC	IF.LOCK	V.TRI	50/60	ST/NONST
	*	*	*	*	*	*	*	*
Status2	H.Lock	*	*	Killer	*	Color.Sys		
	*	*	*	*	*	*	*	*

Control Register Truth Table

Register Name	0 HEX	1 HEX	2 HEX	3 HEX
T.Disable	Tset Enable	Test Disable		
AFC gain&gate	Auto(Gain)	Gain:Fast		
	Auto(Gate)	Non-Gate		
V Reset Timing	Normal	1/4H Shift		
Audio.Mute	Active	Mute		
Video.Mute	Active	Mute		
Sync.Kill	Sync active	Sync killed		
Vsepup	normal	Vsepup		
V.KILL	Vrt active	Vrt killed		
Vertical Test	Normal	Vrt S Corr	Vrt Lin	Vrt Size
Drive.Test	Normal	Test Mode		
Half Tone	Min (Dark)	→	→	Max
Half Tone Def	Half Tone on	Half Tone off		
Blank.Def	Blanking	No Blank		
S.TRAP.SW	Bypass ON	Bypass OFF		
OSD Cnt.Test	Normal	Test Mode		
Coring Gain (w/Defeat)	Defeat	Min	→	Max
Tint.Test	Normal	Test Mode		
Color.Test	Normal	Test Mode		
Video.SW	Internal Mode	External Mode		
Gray Mode	Normal	Gray OSD		
Cross B/W	Normal	Black	White	Cross
CbCr_IN	SECAM Input mode	CbCr Input mode		
G-Y Angle	240deg	253deg		
VBLK SW	24H to 262H (NTSC)	29H to 256H (NTSC)		
	25H to 309H (PAL)	30H to 304H (PAL)		
FBPBLK.SW	FBP not or	FBP or		
fsc or Csync	fsc	Composit Sync		
Y APF	Y Trap	Y APF		
Pre/Over-shoot adj.	Normal	+10ns	+20ns	+30ns
WPL Ope. Point (w/Defeat)	Defeat	High	→	Low
Y Gamma Start	Y Gamma off	Min	→	Max
DC Rest.	100%	106%	113%	128%
Blk.Str.start (w/Defeat)	Defeat	Low	→	High
Blk.Str.Gain	Min	→	Max	
Auto Flesh	OFF	ON		
C.Ext	Internal Mode	External Mode		
C.Bypass	Bypass OFF	Bypass ON		
C_Kill ON	Auto Mode	Killer ON		
C_Kill OFF	Auto Mode	Killer OFF		
Cont.Test	Normal	Test Mode		
Digital OSD	Analog	Digital		
Brт.ABL.Def	Brт ABL On	Brт ABL Off		
Mid.Stp.Def	Mid Stp On	Mid Stp Off		
RGB Temp SW	-1Vbe	Flat		
OVER.MOD. (circuit) SW	circuit OFF	circuit ON		
VOL.FIL	Normal	Filte OFF		
FM.Mute	Active	Mute		
de-em TC.	50μs	75μs		
VIF.Sys.SW	38.0MHz	38.9MHz	45.75MHz	39.5MHz
FM Gain	50kHz dev.	25kHz dev.		
IF.AGC	AGC active	AGC defeat		
Pre/Over SW	Pre-shoot Adj.	Over-shoot Adj.		
C.VCO Adj SW	direction: Plus	direction: Minus		

Continued on next page.

Continued from preceding page.

Register Name	0 HEX	1 HEX	2 HEX	3 HEX
C.VCO Adjust (C.VCO Adj SW: 0)	normal	+30kHz	+60kHz	+90kHz
(C.VCO Adj SW: 1)	-30kHz	-60kHz	-90kHz	-120kHz
Tint Through	Tint Control Enable	Tint Control Disable		
Hlock.Vdet	Individual Operation	Normal		
VIDEO.LEVEL.OFFSET	direction: Minus	Center		direction: Plus

Control Register Truth Table**COUNT DOWN MODE**

	50Hz/60Hz MODE	Standard/Non-Standard MODE
0 HEX	Auto	Auto
1 HEX	50Hz	Auto
2 HEX	60Hz	Auto
3 HEX	Auto	Auto
4 HEX	Auto	Non-Standard
5 HEX	50Hz	Non-Standard
6 HEX	60Hz	Non-Standard
7 HEX	Auto	Non-Standard

Color System

0 HEX	Auto Mode1 PAL/NTSC/4.43NTSC(/SECAM)
1 HEX	Auto Mode2 PAL-M/PAL-N/NTSC
2 HEX	PAL
3 HEX	PAL-M
4 HEX	PAL-N
5 HEX	NTSC
6 HEX	4.43NTSC
7 HEX	SECAM

Filter System

	Y Filter	Chroma Filter
0 HEX	3.58MHz Trap	Peaked 3.58MHz BPF
1 HEX	3.58MHz Trap	Symmetrical 3.58MHz BPF
2 HEX	4.43MHz Trap	Peaked 4.43MHz BPF
3 HEX	4.43MHz Trap	Symmetrical 4.43MHz BPF
4 HEX	6.0MHz Trap	Peaked 3.58MHz BPF
5 HEX	6.0MHz Trap	Symmetrical 3.58MHz BPF
6 HEX	6.0MHz Trap	Peaked 4.43MHz BPF
7 HEX	6.0MHz Trap	Symmetrical 4.43MHz BPF
8-15HEX	4.286MHz Trap	Symmetrical 4.43MHz BPF

Snd.Trap & FM.Det

A2.SW	SIF.Sys.SW	Snd.Trap	FM.det
0 HEX	0 HEX	4.5MHz	4.5MHz
	1 HEX	5.5MHz	5.5MHz
	2 HEX	6.0MHz	6.0MHz
	3 HEX	6.5MHz	6.5MHz
1 HEX	0 HEX		
	1 HEX	5.5MHz	5.74MHz
	2 HEX		
	3 HEX		

Audio Monitor Output

A.MONI.SW	AUDIO.SW	1pin Output	2pin Output
0 HEX	0 HEX	Internal	Internal
	1 HEX	External	
1 HEX	0 HEX	Internal	Internal
	1 HEX	External	External (before VOLUME)

Status Byte Truth Table

Register	0 HEX	1 HEX
RF.AGC	RF.AGC.OUT = "L"	RF.AGC.OUT = "H"
IF.LOCK	IF.PLL Lock	IF.PLL Unlock
V.TRI	V.Triger Undetected	V.Triger Detected
50/60	50	60
ST/NONST	Non-Standard	Standard
H.LOCK	Horiz Unlocked	Horiz Locked
KILLER	KILLER OFF	KILLER ON

Color System	0 HEX	B/W
	1 HEX	PAL
	2 HEX	PAL-M
	3 HEX	PAL-N
	4 HEX	NTSC
	5 HEX	4.43NTSC
	6 HEX	SECAM
	7 HEX	Do not care

Initial Conditions

Register	
T.Disable	1 HEX
AFC gain&gate	0 HEX
H.FREQ	3F HEX
V Reset Timing	0 HEX
Audio.Mute	0 HEX
Video.Mute	0 HEX
H.PHASE	10 HEX
Sync.Kill	0 HEX
V.SIZE	40 HEX
VSEPUP	0 HEX
V.KILL	0 HEX
V.POSI	20 HEX
H BLK L	4 HEX
H BLK R	4 HEX
V.LIN	10 HEX
V.SC	00 HEX
V.TEST	0 HEX
V.COMP	7 HEX
COUNT.DOWN.MODE	0 HEX
R.BIAS	00 HEX
G.BIAS	00 HEX
B.BIAS	00 HEX
RGB Test 4	0 HEX
R.DRIVE	7F HEX
Drive Test	0 HEX
Half Tone	1 HEX
Half Tone Def	1 HEX
G.DRIVE	8 HEX
A2 SW	0 HEX
B.DRIVE	7F HEX
Blank.Def	0 HEX
Sub.Bias	40 HEX
A.MONI.SW	0 HEX
Bright	40 HEX
S.TRAP.SW	1 HEX
Contrast	40 HEX
OSD Cnt.Test	0 HEX
OSD Contrast	0 HEX
Coring Gain (w/Defeat)	0 HEX
Sharpness	00 HEX
Tint.Test	0 HEX
Tint	40 HEX
Color.Test	0 HEX
Color	40 HEX
Video.SW	0 HEX
Trap.Test	4 HEX
Filter.Sys	2 HEX
Gray Mode	0 HEX
Cross B/W	0 HEX
CbCr_IN	0 HEX
G-Y Angle	0 HEX
Color Killer Ope.	4 HEX

Register	
VBLK SW	0 HEX
FBPBLK.SW	1 HEX
fsc or Csync	0 HEX
Y_APF	0 HEX
Pre/Over-shoot Adj.	0 HEX
WPL Ope. Point (W/Defeat)	0 HEX
Y Gamma	0 HEX
DC. Rest.	2 HEX
Blk.Str.start (W/Defeat)	0 HEX
Blk.Str.Gain	1 HEX
Auto Flesh	0 HEX
C.Ext	0 HEX
C.Bypass	1 HEX
C_Kill ON	0 HEX
C_Kill OFF	0 HEX
Color System	0 HEX
Cont. Test	0 HEX
Digitsl OSD	0 HEX
Brт.Abl.Def	0 HEX
Mid.Stp.Def	0 HEX
RGB Temp SW	0 HEX
Bright.Abl.Threshold	4 HEX
R-Y/B-Y Gain Balance	8 HEX
R-Y/B-Y Angle	8 HEX
B-Y DC Level	8 HEX
R-Y DC Level	8 HEX
Audio.SW	0 HEX
Volume	00 HEX
OVER.MOD.SW	0 HEX
VOL.FIL	0 HEX
RF.AGC	20 HEX
FM.Mute	0 HEX
deem.TC	0 HEX
VIF.Sys.SW	1 HEX
SIF.Sys.SW	1 HEX
FM.Gain	0 HEX
IF.AGC	0 HEX
VIDEO.LEVEL	4 HEX
FM.LEVEL	10 HEX
Pre/Over SW	0 HEX
C.VCO Adj SW	0 HEX
C.VCO Adjust	0 HEX
H lock.Vdet	0 HEX
VIDEO.LEVEL.OFFSET	1 HEX
IF.TEST1	0 HEX
OVER.MOD.LEVEL	8 HEX

Control Register Descriptions

Register Name	Bits	General Description
T Disable	1	Disable the Test SW & enable Audio/Video Mute SW
AFC Gain & gate	1	Select horizontal first loop gain & H-sync gating on/off
H Freq.	6	Align ES Sample horizontal frequency
V Reset Timing	1	Select Vertical Reset Timing
Audio Mute	1	Disable audio outputs
Video Mute	1	Disable video outputs
H PHASE	5	Align sync to flyback phase
Sync Kill	1	Force free-run mode
Vertical Size	7	Align vertical amplitude
Vsep.up	1	Select vertical sync. separation sensitivity
Vertical Kill	1	Disable vertical output
V POSI (Vertical DC)	6	Align vertical DC bias
H BLK L	3	H-Blanking Control (Left side of the screen)
H BLK R	3	H-Blanking Control (Right side of the screen)
V LIN (Vertical Linearity)	5	Align vertical linearity
Vertical S-Correction	5	Align vertical S-correction
Vertical Test	2	Select vertical DAC test modes
Vertical Size Compensation	3	Align vertical size compensation
Count Down Mode	1	Select vertical countdown mode
Red Bias	8	Align Red OUT DC level
Green Bias	8	Align Green OUT DC level
Blue Bias	8	Align Blue OUT DC level
Red Drive	7	Align Red OUT AC level
Drive Test	1	Enable Drive control DAC test modes
Half Tone	2	Adjust half tone DC level
Half Tone Defeat	1	Half tone defeat SW
Green Drive	4	Align Green OUT AC level
A2.SW	1	Select 5.74MHz FM.Det
Blue Drive	7	Align Blue OUT AC level
Blank Def	1	Disable RGB output blanking
Sub Bias	7	Align common RGB DC level
A.MONI.SW	1	Select FM Output/Selected Audio Output
Brightness Control	7	Customer brightness control
S.TRAP.SW	1	Select Snd Trap bypass
Contrast Control	7	Customer contrast control
OSD Contrast Test	1	Enable OSD Contrast DAC test mode
OSD Contrast Control	2	Align OSD AC level
Coring Gain Select (with Defeat)	2	Select Coring Gain (0hex: Defeat)
Sharpness Control	6	Customer sharpness control
Tint Test	1	Enable tint DAC test mode
Tint Control	7	Customer tint control
Color Test	1	Enable color DAC test mode
Color Control	7	Customer color control
Video SW	1	Select Video source
Trap.Test	3	Trap Test
Filter System	3	Select Y/C Filter mode
Gray Mode	1	OSD Gray Tone Enable
Cross B/W	2	Service Test Mode (normal/Black/White/Cross)
CbCr_Input Enable SW	1	Enable CbCr Input (Disable SECAM Input)
G-Y Angle Select	1	Select G-Y Angle
Color Killer Operational Point Select	3	Select Color Killer Operational Point
Vertical Blanking SW	1	Select VBLK Period

Continued on next page.

Continued from preceding page.

Register Name	Bits	General Description
FBPBLK.SW	1	Enable RGB Blanking or FBP
fsc or Csync SW	1	Select fsc output or Composit sync output
Y APF Enable SW	1	Select the frequency characteristic of 3.58MHzTrap. It is useful for 3.58MHzTrap or APF.
Pre/Over-shoot Adjustment	2	Select Pre-shoot Width
WPL Ope. Point (W/Defeat)	2	Select WPL Operating Point
Y Gamma Start	2	Enable luminance coring
DC Restoration Select	2	Select Luma DC Restoration
Blk. Str. Start Point Select (w/Defeat)	2	Select Black stretch Start Point (w/ Defeat)
Blk. Str. Gain Select	2	Select Black stretch Gain
AutoFlesh	1	Enable AutoFlesh function
C Ext	1	Selected-C In SW on
C Bypass	1	Select Chroma BPF bypass
C Kill On	1	C Kill Mode (1: Enable Killer circuit)
C Kill Off	1	Disable Killer circuit
Color System	3	Select Color System
Cont Test	1	Enable contrast DAC test mode
Digital OSD SW	1	Select Digital/Analog OSD
Bright ABL Defeat	1	Disable brightness ABL
Bright Mid Stop Defeat	1	Disable brightness mid stop
RGB Temp SW	1	Select temperature characteristic of RGB Output
Bright ABL Threshold	3	Align brightness ABL threshold
R-Y/B-Y Balance	4	R-Y/B-Y Gain Balance
R-Y/B-Y Angle	4	R-Y/B-Y Angle
B-Y DC Level	4	B-Y DC Level (White-Balance)
R-Y DC Level	4	R-Y DC Level (White-Balance)
Audio SW	1	Select Audio source
Volume Control	7	Customer volume control
OVER.MOD.SW	1	Select overmodulation circuit ON/OFF
Volume Filter Defeat	1	Disable volume DAC filter
RF AGC Delay	6	Align RF AGC threshold
FM Mute	1	Disable FM outputs
de-em TC.	1	Select de-emphasis Time Constant
VIF System SW	2	Select 38.0/38.9/39.5/45.75
SIF System SW	2	Select 4.5/5.5/6.0/6.5
FM Gain	1	Select FM Output Level
IF AGC Defeat	1	Disable IF and RF AGC
Video Level	3	Align IF video level
FM Level	5	Align FM output level
Pre/Over SW	1	Select control for Pre/Over-shoot Adjustment
C VCO Adjust SW	1	Select the direction of C. VCO adjustment
C VCO Adjust	2	Align C. VCO's frequency
Tint Through	1	Select tint control operation (enable or disable)
H Lock Vdet	1	Select vertical sync. Operation
VIDEO.LEVEL.OFFSET	2	Align IF video level
IF TEST1	1	Select test modes
OVER.MOD.LEVEL	4	Align overmodulation performance

Reed Status

RF.AGC	0: RFAGC OUT = low, 1: RFAGC OUT = high See the separately provided documentation (application note) for details.
IF.LOCK	0: IF. PLL=Lock, 1: IF. PLL=Unlock
V.TRI	Returns the VCD internal vertical trigger detection circuit output to the bus. The internal memory state is updated on each vertical period. 1HEX: Detected.
50/60	Returns the VCD internal 50Hz/60Hz detection circuit output to the bus.
ST/NONST	Returns the VCD standard (262.5H) or nonstandard internal vertical trigger detection circuit output to the bus. Returns the output of the flip-flop that determines the VCD internal mode in real time. 1HEX: Standard For more information, refer to the separately provided documentation and then contact your Sanyo representative with questions.
H.Lock	Performs a phase comparison between FBP and Hsync, integrates that output, and detects the locked state about 40H after the horizontal VCO locks. This state is returned in real time in response to a bus read. 1HEX: Locked
KILLER	Returns the state of the color killer. Note, however, that the time constant is long and a time of roughly one vertical period (16 ms) is required for detection. Applications must be careful concerning the wait period associated with a device state change. This state is returned in real time in response to a bus read. 1HEX: Killer on
Color sys	Returns the color system state See the register truth table's color system table. The read status is the same as that for bus write.

- SANYO Semiconductor Co.,Ltd. assumes no responsibility for equipment failures that result from using products at values that exceed, even momentarily, rated values (such as maximum ratings, operating condition ranges, or other parameters) listed in products specifications of any and all SANYO Semiconductor Co.,Ltd. products described or contained herein.
- SANYO Semiconductor Co.,Ltd. strives to supply high-quality high-reliability products, however, any and all semiconductor products fail or malfunction with some probability. It is possible that these probabilistic failures or malfunction could give rise to accidents or events that could endanger human lives, trouble that could give rise to smoke or fire, or accidents that could cause damage to other property. When designing equipment, adopt safety measures so that these kinds of accidents or events cannot occur. Such measures include but are not limited to protective circuits and error prevention circuits for safe design, redundant design, and structural design.
- In the event that any or all SANYO Semiconductor Co.,Ltd. products described or contained herein are controlled under any of applicable local export control laws and regulations, such products may require the export license from the authorities concerned in accordance with the above law.
- No part of this publication may be reproduced or transmitted in any form or by any means, electronic or mechanical, including photocopying and recording, or any information storage or retrieval system, or otherwise, without the prior written consent of SANYO Semiconductor Co.,Ltd.
- Any and all information described or contained herein are subject to change without notice due to product/technology improvement, etc. When designing equipment, refer to the "Delivery Specification" for the SANYO Semiconductor Co.,Ltd. product that you intend to use.
- Information (including circuit diagrams and circuit parameters) herein is for example only; it is not guaranteed for volume production.
- Upon using the technical information or products described herein, neither warranty nor license shall be granted with regard to intellectual property rights or any other rights of SANYO Semiconductor Co.,Ltd. or any third party. SANYO Semiconductor Co.,Ltd. shall not be liable for any claim or suits with regard to a third party's intellectual property rights which has resulted from the use of the technical information and products mentioned above.

This catalog provides information as of November, 2007. Specifications and information herein are subject to change without notice.