

### General Description

LA8525/A is a current mode, step-down DC-DC converter that is designed to meet 2A output current, and utilizes PWM control scheme that switches with 500KHz fixed frequency.

The input voltage range of LA8525/A is from 4.5V to 21V, and available in adjustable output voltage from 0.8V to  $V_{IN}$ . The supply current is only 1mA during operation and under 20uA in shutdown.

This device provides an enable function that can be controlled by external logic signal. It also provides excellent regulation during line or load transient. Other features of soft-start, current limit, thermal shutdown protection, and short circuit protection are also included. To increase light-load conversion efficiency, the Power-Saving Mode (PSM) feature is automatically activated. This device can also operate with a maximum duty cycle of 100% for use in low drop-out conditions. The package is available in standard SOP-8.

### Ordering Information

LA8525/A **1 2 3 4** ; (A: Bonding Code)

- 1** (Package Type) => **J**: SOP
- 2** (Number of Pins) => **G**: 8 pin
- 3** (Output Voltage) => **Blank**: Adjustable
- 4** (Special Feature) => **Blank**: N/A

### Available Part Number

- LA8525JG
- LA8525AJG

### Features

- | 4.5V to 21V Input Voltage Range
- | Continuous 2A Output Capability
- | 0.8V Reference Voltage
- | 100% Duty Cycle
- | 20uA Low Shutdown Current
- | 1mA Low Supply Current
- | 500KHz Switching Frequency in PWM Mode
- | Power-Saving Mode (PSM) at Light-Load
- | Current Mode for Excellent Response
- | Internal Soft-Start & Current Limit
- | No External Compensation Required
- | Support Low ESR Output Ceramic Capacitors
- | Short Circuit & Thermal Shutdown Protection
- | Standard SOP-8 Package
- | Meet RoHS Standard

### Applications

- | Wireless / Broadband Communication
- | LCD TV / Monitor
- | Set-Top-Box
- | Portable Device

### Marking Information

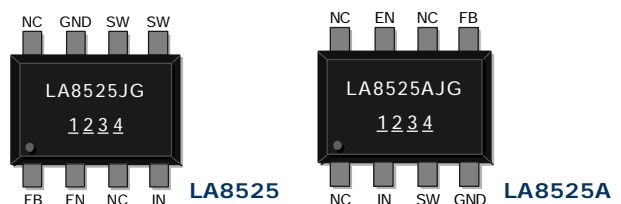

#### 1 2 (Date Code)

For date code rule, please contact our sales representative directly.

#### 3 4 (Internal Code)

## Typical Application

1  $V_{IN}=5V, V_{OUT}=1.2V$

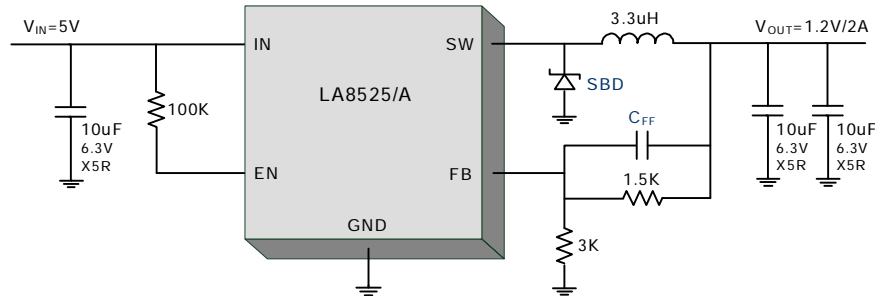

1  $V_{IN}=12V, V_{OUT}=5V$ , for Adaptor Hot-plug Application

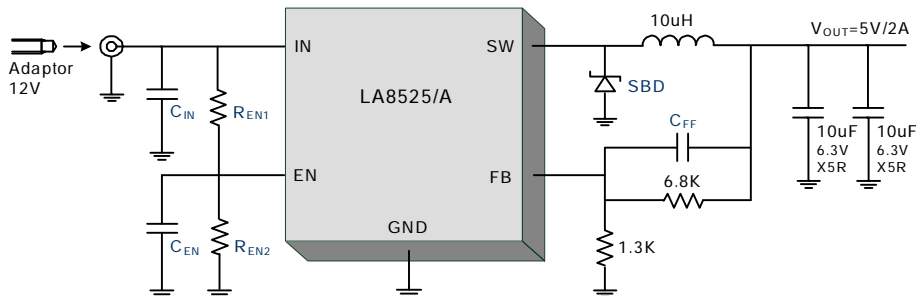

### Application Notes:

1. The value of 2.2nF is recommended for  $C_{FF}$ . It is the optional Feed-forward Capacitor for improve load transient response.
2. SBD is Schottky Barrier Diode. The maximum rating must higher than the output current and input voltage.
3. The MLCC of 10uF/25V/X5R is enough for  $C_{IN}$ , but sometimes the electrolytic capacitor such as 47uF or more will be necessary for eliminate input overshooting voltage from the adaptor hot-plug application.
4. The  $R_{EN1}$ ,  $R_{EN2}$  and  $C_{EN}$  are used to avoid EN which may be damaged from the adaptor hot-plug application. The recommended value of  $R_{EN1}$  is 100KOhm,  $R_{EN2}$  is 47KOhm, and  $C_{EN}$  is 100nF.

## Efficiency Curve

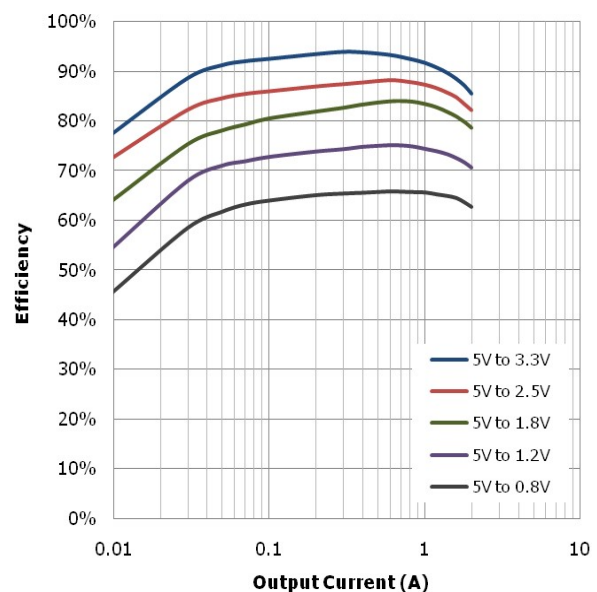
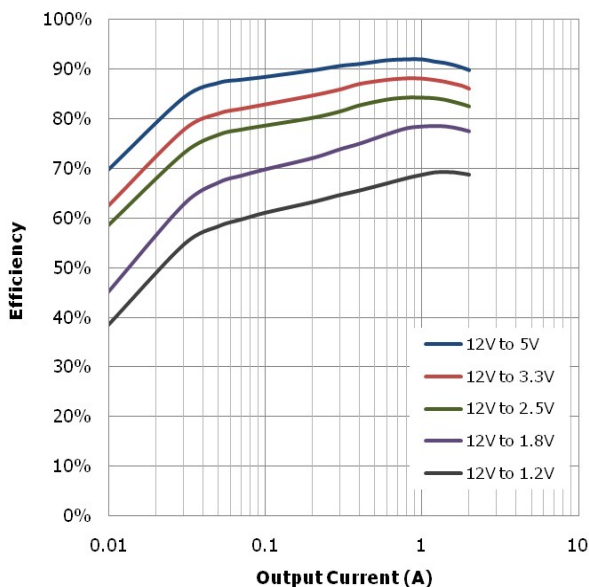

## Quick Design Table

For 2A output current,  $\Delta I_L = 0.6A$ , continuous current mode operation.

**L1**: Recommended Inductor

**R1**: Output Voltage Divider

**R2**: Output Voltage Divider

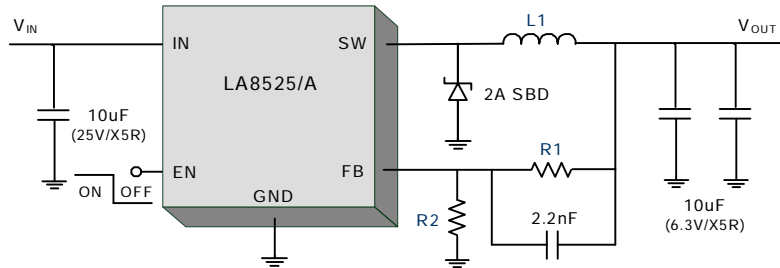

$V_{OUT}$ \ $V_{IN}$	5V	9V	12V
0.8V	L1 : 2.2uH R1 : 2.5KOhm R2 : NC	L1 : 4.7uH R1 : 2.5KOhm R2 : NC	L1 : 4.7uH R1 : 2.5KOhm R2 : NC
1.0V	L1 : 3.3uH R1 : 2.5KOhm R2 : 10Kohm	L1 : 4.7uH R1 : 2.5KOhm R2 : 10Kohm	L1 : 4.7uH R1 : 2.5KOhm R2 : 10Kohm
1.1V	L1 : 3.3uH R1 : 1KOhm R2 : 2.7Kohm	L1 : 4.7uH R1 : 1KOhm R2 : 2.7Kohm	L1 : 4.7uH R1 : 1KOhm R2 : 2.7Kohm
1.2V	L1 : 3.3uH R1 : 1.5KOhm R2 : 3Kohm	L1 : 4.7uH R1 : 1.5KOhm R2 : 3Kohm	L1 : 4.7uH R1 : 1.5KOhm R2 : 3Kohm
1.5V	L1 : 3.3uH R1 : 1.3KOhm R2 : 1.5Kohm	L1 : 4.7uH R1 : 1.3KOhm R2 : 1.5KOhm	L1 : 4.7uH R1 : 1.3KOhm R2 : 1.5Kohm
1.8V	L1 : 4.7uH R1 : 2.5KOhm R2 : 2Kohm	L1 : 4.7uH R1 : 2.5KOhm R2 : 2Kohm	L1 : 4.7uH R1 : 2.5KOhm R2 : 2Kohm
2.5V	L1 : 4.7uH R1 : 4.7KOhm R2 : 2.2Kohm	L1 : 6.8uH R1 : 4.7KOhm R2 : 2.2Kohm	L1 : 6.8uH R1 : 4.7KOhm R2 : 2.2Kohm
2.8V	L1 : 6.8uH R1 : 5.1KOhm R2 : 2Kohm	L1 : 6.8uH R1 : 5.1KOhm R2 : 2Kohm	L1 : 6.8uH R1 : 5.1KOhm R2 : 2Kohm
3.0V	L1 : 6.8uH R1 : 6.8KOhm R2 : 2.5Kohm	L1 : 6.8uH R1 : 6.8KOhm R2 : 2.5Kohm	L1 : 10uH R1 : 6.8KOhm R2 : 2.5Kohm
3.3V	L1 : 10uH R1 : 4.7KOhm R2 : 1.5Kohm	L1 : 6.8uH R1 : 4.7KOhm R2 : 1.5Kohm	L1 : 10uH R1 : 4.7KOhm R2 : 1.5Kohm
5V		L1 : 10uH R1 : 6.8KOhm R2 : 1.3KOhm	L1 : 10uH R1 : 6.8KOhm R2 : 1.3Kohm

The green type denotes that the output electrolytic capacitor such as 100uF or more will be necessary for compensate the control loop.

## Functional Block Diagram

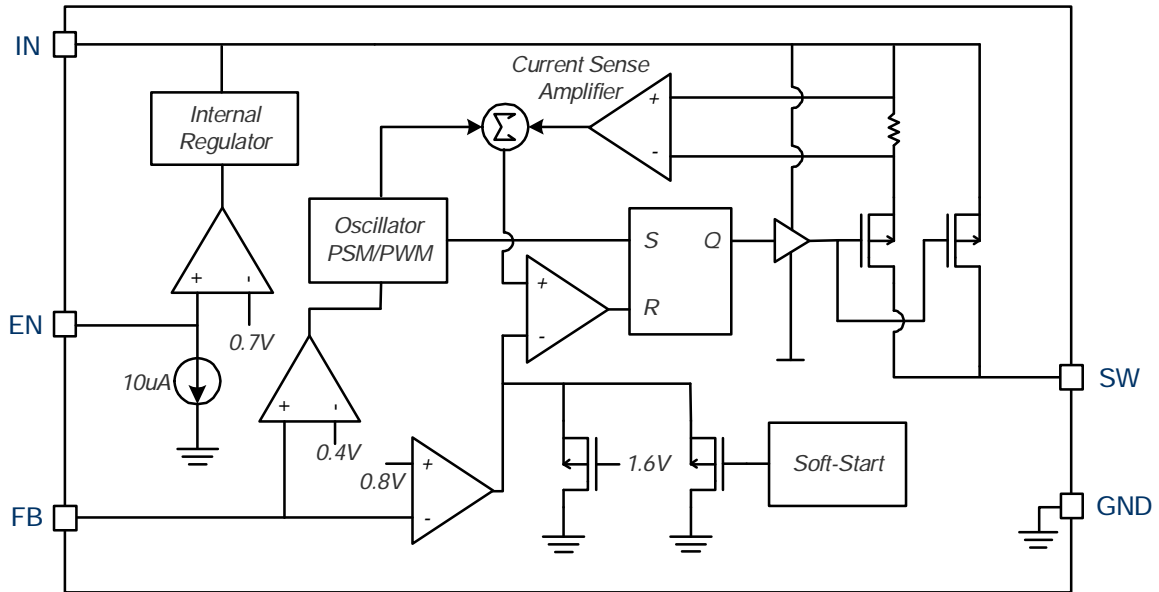

## Pin Configurations

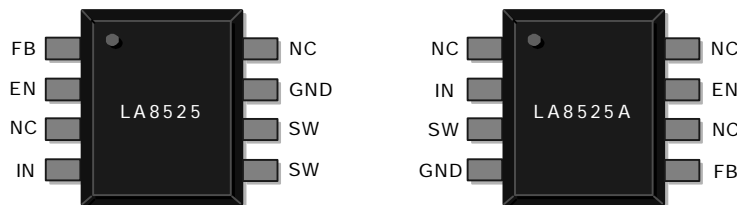

Name	Description
<b>IN</b>	Power Input. The capacitance of 10uF or greater must be connected from this pin to ground to bypass noise on the input of the IC.
<b>SW</b>	Power Switch Output. This pin is the switching node that supplies power to the output. Connect an L-C filter from SW to the output load.
<b>GND</b>	Ground. Connect this pin to the circuit ground.
<b>FB</b>	Feedback. Connect this pin to a voltage divider to set the output voltage.
<b>EN</b>	Enable Input. EN is a digital input that turns the regulator on or off. Float EN or force it LOW to turn off the regulator, force it HIGH to turn on the regulator. If this feature is not needed, connect EN to IN with a 100KOhm pull-high resistor for automatic start-up.
<b>NC</b>	No Connection.

## Absolute Maximum Ratings

Parameter	Rating
Input Voltage	23V
SW Pin Voltage Range	-0.5V ~ $V_{IN}+0.5V$
FB Pin Voltage Range	-0.3V ~ 6V
EN Pin Voltage Range	-0.3V ~ $V_{IN}+0.3V$
Storage Temperature Range	-65°C ~ 150°C
Junction Temperature	150°C
Lead Soldering Temperature (10 sec)	300°C

These are stress ratings only and functional operation is not implied. Exposure to absolute maximum ratings for prolonged time periods may affect device reliability. All voltages are with respect to ground.

## Recommended Operating Conditions

Parameter	Rating
Input Voltage Range	4.5V ~ 21V
Ambient Temperature Range	-40°C ~ 85°C
Junction Temperature Range	-40°C ~ 125°C

These are conditions under which the device functions but the specifications might not be guaranteed. For guaranteed specifications and test conditions, please see the *Electrical Specifications*.

## Package Information

Parameter	Package	Symbol	Rating
Thermal Resistance (Junction to Case)	SOP-8	$\theta_{JC}$	40 °C/W
Thermal Resistance (Junction to Ambient)		$\theta_{JA}$	105 °C/W

## Electrical Specifications

$V_{IN}=12V$ ,  $T_A=25^{\circ}C$ , unless otherwise noted.

Parameter	Test Condition	Min.	Typ.	Max.	Units
Feedback Voltage	$I_{LOAD}=0.1A$	0.784	0.8	0.816	V
Oscillation Frequency		400	500	600	KHz
Frequency of Short Circuit Protection			100		KHz
Duty Cycle	$V_{FB}=0V$		100		%
	$V_{FB}=1.5V$		0		
Internal MOSFET ON Resistance			220		m $\Omega$
Current Limit			3.8		A
Supply Current	$V_{FB}=1.5V$		1		mA
Shutdown Current	$V_{EN}=0V$		20		$\mu A$
EN Pin Input Threshold Voltage	Regulator OFF		1.3	0.8	V
	Regulator ON	2.0			
EN Pin Bias Current	Regulator OFF		1		$\mu A$
	Regulator ON		20		
FB Pin Bias Current	$I_{LOAD}=0.1A$		0.1	0.5	$\mu A$
Soft-Start Time			1		ms
Line Regulation	$V_{IN}=4.5V\sim 21V$ , $I_{LOAD}=0.1A$		0.5		%
Load Regulation	$I_{LOAD}=0.1A\sim 2A$		0.5		%
Over Temperature Shutdown			150		$^{\circ}C$
Over Temperature Shutdown Hysteresis			40		$^{\circ}C$

## Typical Performance Characteristics

$V_{IN}=12V$ ,  $V_{OUT}=3.3V$ ,  $I_{OUT}=200mA$ ,  $T_A=25^{\circ}C$ , unless otherwise noted.

*Feedback Voltage vs. Input Voltage*

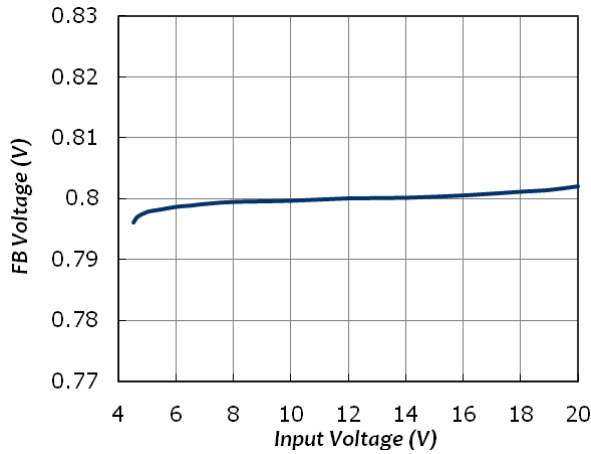

*Feedback Voltage vs. Temperature*

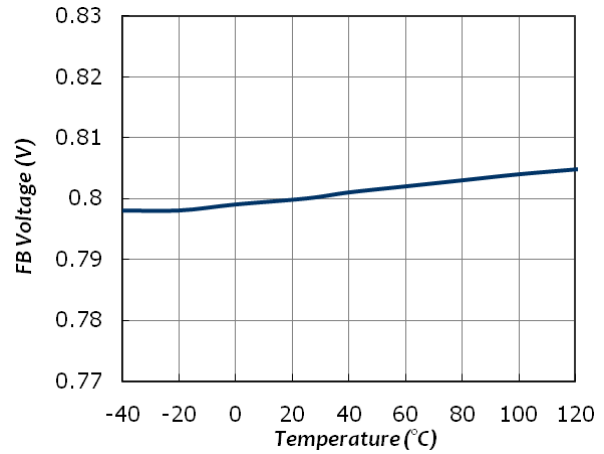

*Frequency vs. Input Voltage*

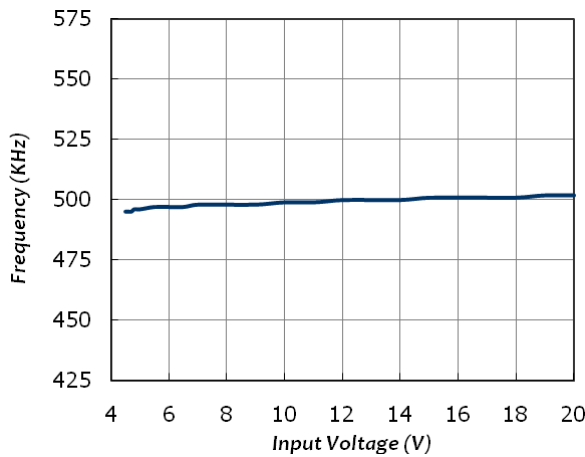

*Frequency vs. Temperature*

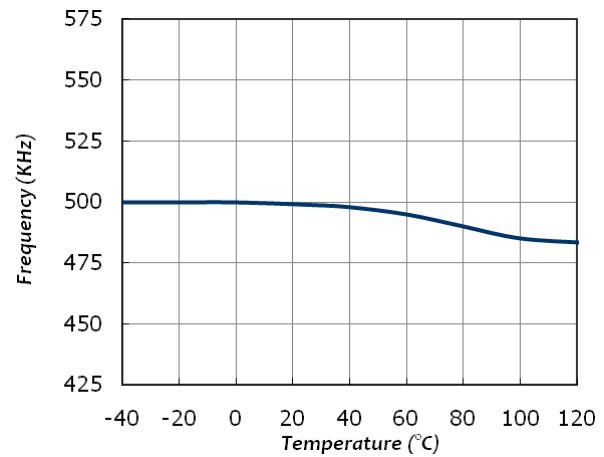

*SCP Frequency vs. Input Voltage*

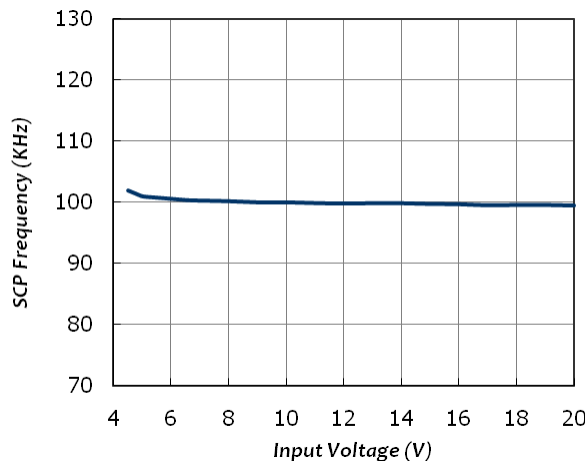

*SCP Frequency vs. Temperature*

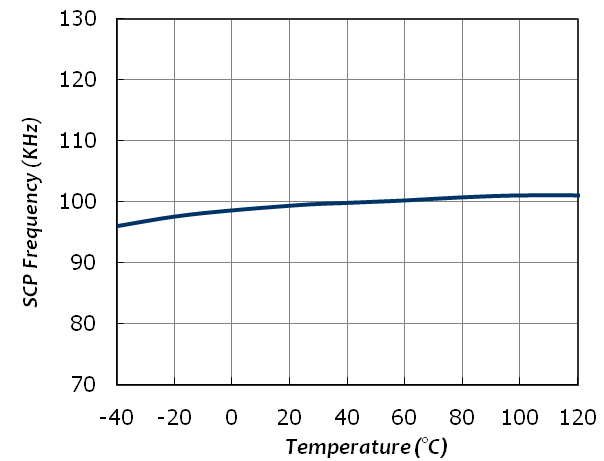

## Typical Performance Characteristics (Contd.)

Supply Current vs. Input Voltage

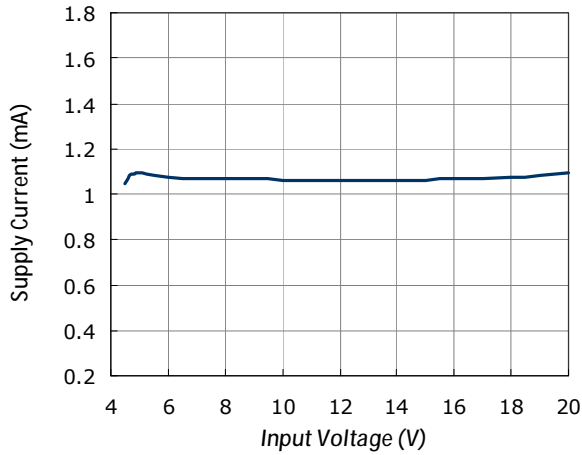

Supply Current vs. Temperature

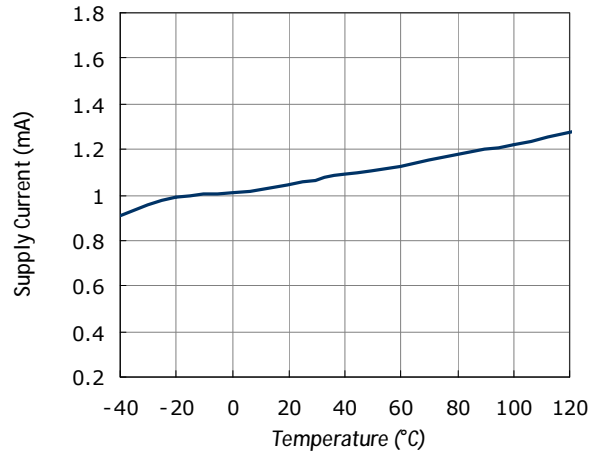

Shutdown Current vs. Input Voltage

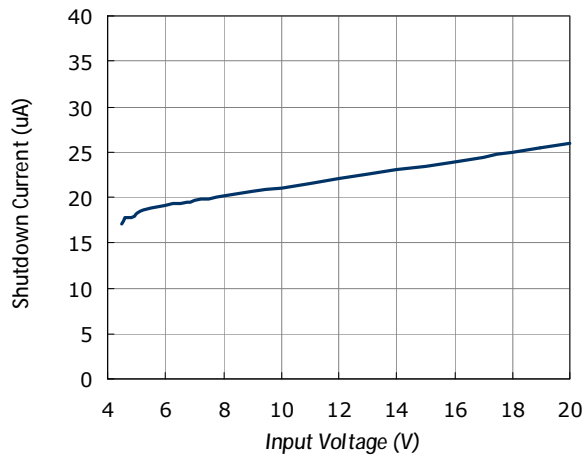

Shutdown Current vs. Temperature

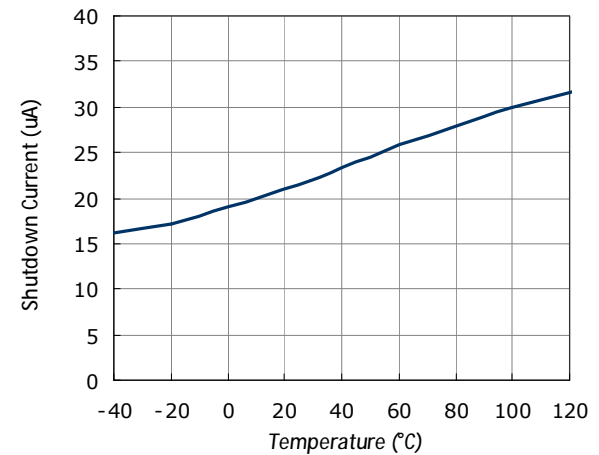

Line Regulation

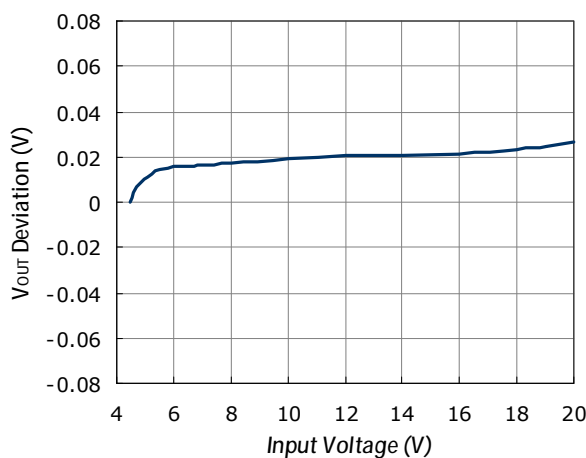

Load Regulation

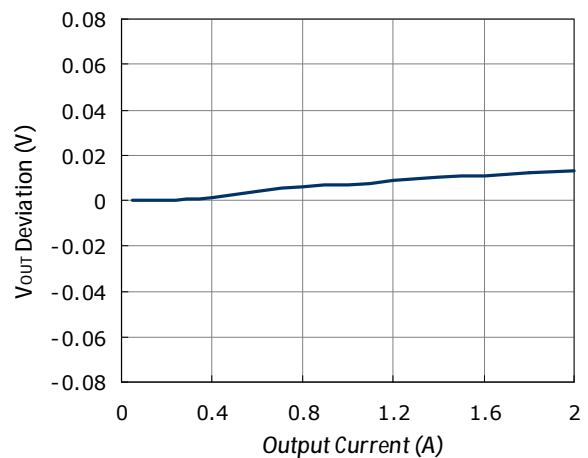



## Typical Performance Characteristics (Contd.)

$V_{IN}=12V$ ,  $V_{OUT}=5V$ ,  $I_{OUT}=2A$ ,  $T_A=25^{\circ}C$ , unless otherwise noted.

### Output Voltage Ripple

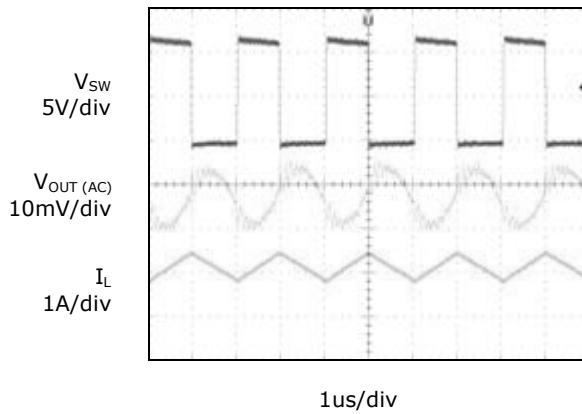

### Short Circuit Protection

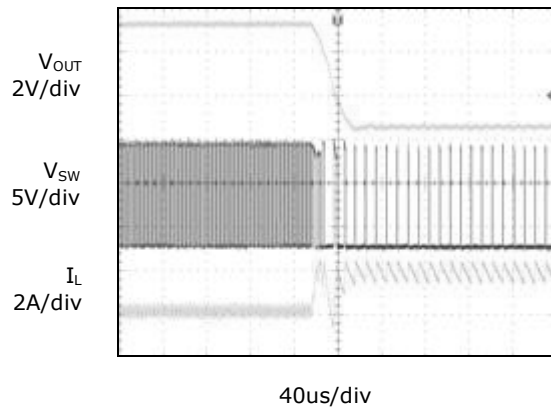

### Enable

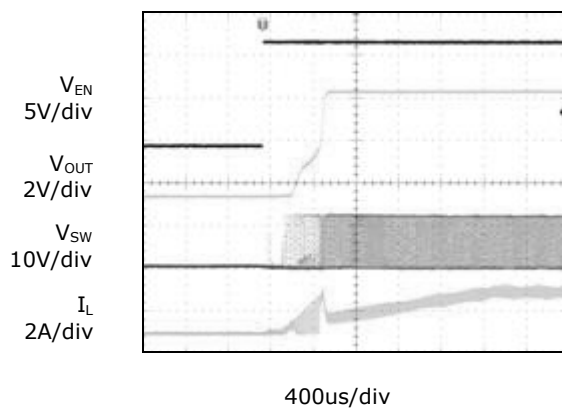

### Shutdown

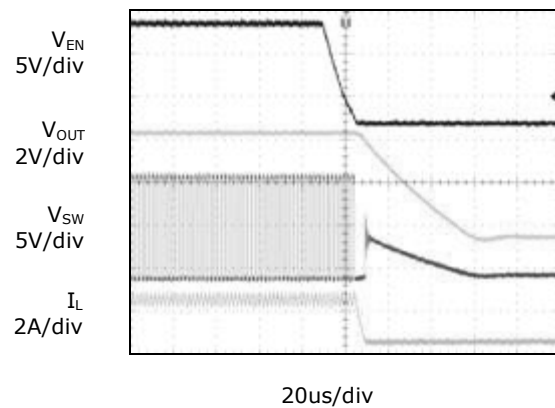

### Load Transient

12V to 5V,  $I_{OUT}=500mA \sim 1.5A$ ,  $T_r=T_f=250mA/us$

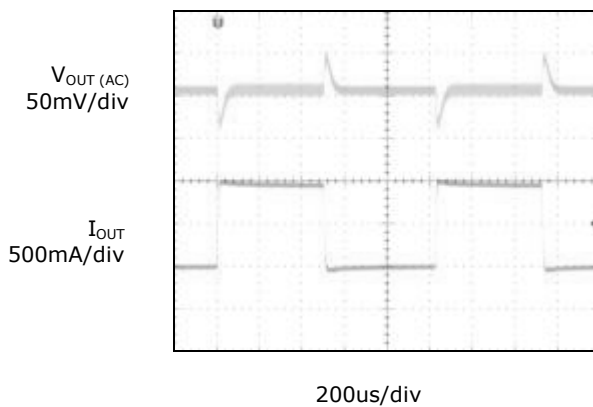

### Load Transient

5V to 1.2V,  $I_{OUT}=500mA \sim 1.5A$ ,  $T_r=T_f=250mA/us$

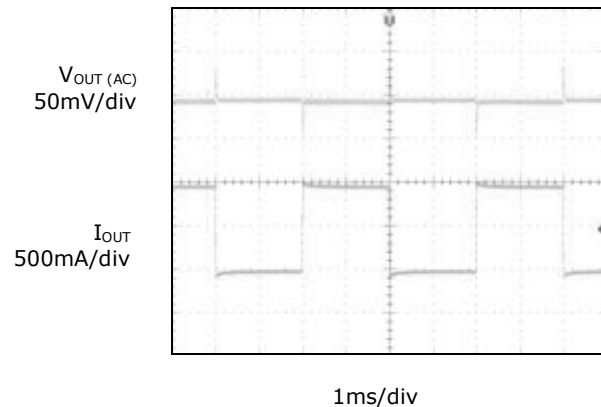

## Application Information

### Output Voltage Programming

LA8525/A develops a band-gap between the feedback pin and ground pin. Therefore, the output voltage can be formed by R1 and R2. Use 1% metal film resistors for the lowest temperature coefficient and the best stability. Select lower resistor value to minimize noise pickup in the sensitive feedback pin, or higher resistor value to improve efficiency.

The output voltage is given by the following formula:

$$V_{OUT} = V_{FB} \times ( 1 + R1 / R2 ) \quad \text{where } V_{FB} = 0.8V$$

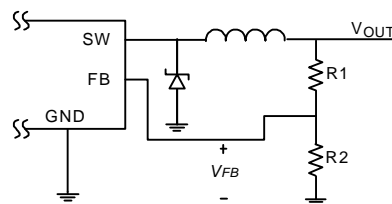

### Short Circuit Protection

When the output is shorted to ground, the protection circuit will be triggered and force the oscillation frequency down to approximately 100KHz. The oscillation frequency will return to the normal value once the short circuit condition is removed.

### Thermal Shutdown Protection

The thermal protection circuit limits total power dissipation in this device. When the junction temperature exceeds approximately 150°C, the thermal sensor signals the shutdown logic turning off this device. The thermal sensor will turn this device on again after the junction temperature cools by approximately 40°C.

### Power-Saving Mode Operation (PSM)

During normal operation, the oscillation frequency of PWM is internally set to 500KHz. At light-loads, this device will automatically skip pulses in PSM operation to improve conversion efficiency. The threshold current of PSM to PWM is approximately 100mA~400mA.

### Soft-Start

This device includes soft-start function without external circuit. It is useful to reduce supply inrush current, and prevent output voltage from overshooting during start-up. The typical soft-start time is approximately 1ms.

## Delay Start-up

The following circuit uses the EN pin to provide a time delay between the input voltage is applied and the output voltage comes up. As the instant of the input voltage rises, the charging of capacitor  $C_{DELAY}$  pulls the EN pin low, keeping the device off. Once the capacitor voltage rises above the EN pin threshold voltage, the device will start to operate. The start-up delay time can be calculated by the following formula:

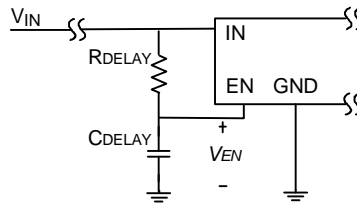

$$V_{IN} \times (1 - e^{-T/(R \times C)}) > V_{EN}$$

Where T is the start-up delay time, R is  $R_{DELAY}$ , C is  $C_{DELAY}$ , and the typical  $V_{EN}$  is 1.3V.

This feature is useful in situations where the input power source is limited in the amount of current it can deliver. It allows the input voltage to rise to a higher voltage before the device starts operating.

## Snubber Circuit

The simple RC snubber is used for voltage transient and ringing suppression. The high frequency ringing and voltage overshooting at the SW pin is caused by fast switching transition and resonating circuit parasitical elements in the power circuit. It maybe generates EMI and interferes with circuit performance. Reserve a snubber circuit in the PC board is preferred to damp the ringing due to the parasitical capacitors and inductors of layout. The following circuit is a simple RC snubber:

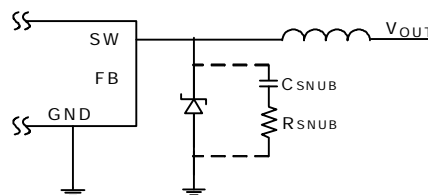

Choose the value of RC network by the following procedure:

- (1) Measure the voltage ringing frequency ( $f_R$ ) of the SW pin.
- (2) Find a small capacitor and place it across the SW pin and the GND pin to damp the ringing frequency by half.

(3) The parasitical capacitance ( $C_{PAR}$ ) at the SW pin is 1/3 the value of the added capacitance above. The parasitical inductance ( $L_{PAR}$ ) at the SW pin is:

$$L_{PAR} = \frac{1}{(2\pi f_R)^2 \times C_{PAR}}$$

(4) Select the value of  $C_{SNUB}$  that should be more than 2~4 times the value of  $C_{PAR}$  but must be small enough so that the power dissipation of  $R_{SNUB}$  is kept to a minimum. The power rating of  $R_{SNUB}$  can be calculated by following formula:

$$P_{RSNUB} = C_{SNUB} \times V_{IN}^2 \times f_S$$

(5) Calculate the value of  $R_{SNUB}$  by the following formula and adjust the value to meet the expectative peak voltage.

$$R_{SNUB} = 2\pi \times f_R \times L_{PAR}$$

### Thermal Considerations

The power dissipation across this device can be calculated by the following formula:

$$P_D = I_{LOAD}^2 \times R_{DS(ON)} \times \frac{V_{OUT}}{V_{IN}} + \frac{1}{2} \times V_{IN} \times I_{OUT} \times (t_r + t_f) \times f_S + Q_g \times V_{GS} \times f_S + V_{IN} \times I_S$$

Where  $f_S$  is the 500KHz switching frequency,  $(t_r+t_f)$  is the switching time that is approximately 20ns,  $Q_g$  is the power MOSFET gate charge that is approximately 1.1nC,  $V_{GS}$  is the gate voltage of the power MOSFET that is approximately 5.5V, and  $I_S$  is the 1mA supply current.

The maximum power dissipation of this device depends on the thermal resistance of the IC package and PCB layout, the temperature difference between the die junction and ambient air, and the rate of airflow. The maximum power dissipation can be calculated by the following formula:

$$P_{D(MAX)} = \frac{(T_J - T_A)}{\theta_{JA}}$$

Where  $T_J - T_A$  is the temperature difference between the die junction and surrounding environment,  $\theta_{JA}$  is the thermal resistance from the junction to the surrounding environment. For continuous operation, do not exceed the maximum operation junction temperature 125°C.

The value of junction to case thermal resistance  $\theta_{JC}$  is also popular to users. This thermal parameter is convenient for users to estimate the internal junction operated temperature of packages while IC operating. The operated junction temperature can be calculated by the following formula:

$$T_J = T_C + P_D \times \theta_{JC}$$

$T_C$  is the package case temperature measured by thermal sensor. Therefore it's easy to estimate the junction temperature by any condition.

There are many factors affect the thermal resistance. Some of these factors include trace width, copper thickness, total PCB copper area, and etc. For the best thermal performance, wide copper traces and generous amounts of PCB copper should be used in the board layout. If further improve thermal characteristics are needed, double sided and multi-layer PCB with large copper areas and airflow will be recommended.

### *Layout Considerations*

PC board layout is very important, especially for switching regulators of high frequencies and large peak currents. A good layout minimizes EMI on the feedback path and provides best efficiency. The following layout guides should be used to ensure proper operation of this device.

- (1) The power charge path that consists of the IN trace, the SW trace, the external inductor and the GND trace should be kept wide and as short as possible.
- (2) The power discharge path that consists of the SW trace, the external inductor, the rectifier diode and the GND trace should be kept wide and as short as possible.
- (3) The feedback path of voltage divider should be close to the FB pin and keep noisy traces away; also keep them separate using grounded copper.
- (4) The input capacitors should be close to the regulator and rectifier diode.
- (5) The output capacitors should be close to the load.

## Component Selection

### Inductor Selection

The conduction mode of power stage depends on input voltage, output voltage, output current, and the value of the inductor. Select an inductor to maintain this device operating in continuous conduction mode (CCM). The minimum value of inductor can be determined by the following procedure.

(1) Calculate the minimum duty ratio:

$$D_{(MIN)} = \frac{V_{OUT} + I_{LOAD} \times DCR + V_F}{V_{IN(MAX)} - I_{LOAD} \times R_{DS(ON)} + V_F} = \frac{T_{ON}}{T_S}$$

Where DCR is the DC resistance of the inductor,  $V_F$  is the forward voltage of the rectifier diode, and  $T_S$  is the switching period.

This formula can be simplified as below:

$$D_{(MIN)} = \frac{V_{OUT}}{V_{IN(MAX)}} = \frac{T_{ON}}{T_S} ; 0 \leq D \leq 1$$

(2) Define a value of minimum current that is approximately 10%~30% of full load current to maintain continuous conduction mode, usually referred to as the critical current ( $I_{CRIT}$ ).

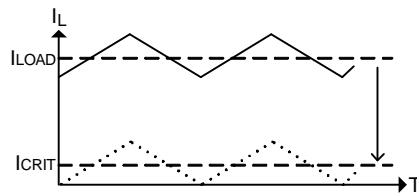

$$I_{CRIT} = \delta \times I_{LOAD} ; \delta = 0.1 \sim 0.3$$

(3) Calculate the inductor ripple current ( $\Delta I_L$ ). In steady state conditions, the inductor ripple current increase, ( $\Delta I_{L+}$ ), during the ON time and the current decrease, ( $\Delta I_{L-}$ ), during the OFF time must be equal.

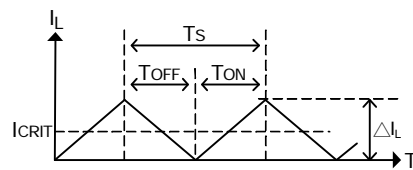

$$\Delta I_L = 2 \times I_{CRIT}$$

(4) Calculate the minimum value of inductor use maximum input voltage. That is the worst case condition because it gives the maximum  $\Delta I_L$ .

$$L \geq \frac{[V_{IN(MAX)} - I_{LOAD} \times (R_{DS(ON)} + DCR) - V_{OUT}] \times D_{(MIN)}}{\Delta I_L \times f_s}$$

This formula can be simplified to

$$L \geq \frac{(V_{IN(MAX)} - V_{OUT}) \times D_{(MIN)}}{\Delta I_L \times f_s}$$

The higher inductance results in lower output ripple current and ripple voltage. But it requires larger physical size and price.

(5) Calculate the inductor peak current and choose a suitable inductor to prevent saturation.

$$I_{L(\text{PEAK})} = I_{\text{LOAD}} + \frac{\Delta I_L}{2}$$

Coil inductors and surface mount inductors are all available. The surface mount inductors can reduce the board size but they are more expensive and its larger DC resistance results in more conduction loss. The power dissipation is due to the DC resistance can be calculated as below:

$$P_{D\_INDUCTOR} = I_{\text{LOAD}}^2 \times \text{DCR}$$

### Rectifier Diode Selection

The rectifier diode provides a current path for the inductor current when the internal power MOSFET turns off. The best solution is Schottky diode, and some parameters about the diode must be take care as below:

- (1) The forward current rating must be higher than the continuous output current.
- (2) The reverse voltage rating must be higher than the maximum input voltage.
- (3) The lower forward voltage will reduce the conduction loss.
- (4) The faster reverse recovery time will reduce the switching loss, but it is very small compared to conduction loss.
- (5) The power dissipation can be calculated by the forward voltage and output current for the time that the diode is conducting.

$$P_{D\_DIODE} = I_{\text{LOAD}} \times V_F \times (1 - D)$$

### Input Capacitor Selection

The input capacitor is required to supply current to the regulator and maintain the DC input voltage. The low ESR (Equivalent Series Resistance) capacitors are preferred those provide the better performance and the less input ripple voltage ( $\Delta V_{\text{IN}}$ ).

Assuming the input current of the regulator is constant, the required input capacitance for a given input ripple voltage can be calculated as below:

$$C_{\text{IN}} = \frac{I_{\text{LOAD}(\text{MAX})} \times D \times (1 - D)}{f_s \times (\Delta V_{\text{IN}} - I_{\text{LOAD}(\text{MAX})} \times \text{ESR})}$$

A 10uF ceramic capacitor with X7R or X5R for most applications is sufficient.

The capacitors' ESR and ripple current result in power dissipation that will increase the internal temperature. Usually, the capacitors' manufacturers specify ripple current ratings and should not be exceeded to prevent excessive temperature shorten the life time. Choose a smaller inductor causes higher ripple current which maybe result in the capacitor overstress. The input capacitors' RMS current rating can be calculated by following formula and should not be exceeded.

$$I_{RMS} = I_{LOAD (MAX)} \times \sqrt{D \times (1 - D)}$$

This formula has a maximum at  $V_{IN}=2V_{OUT}$ . That is the worst case and the above formula can be simplified to:

$$I_{RMS} = \frac{I_{LOAD (MAX)}}{2}$$

Therefore, choose a suitable capacitor at input whose ripple current rating must greater than half of the maximum load current. The power dissipation of input capacitor causes a small conduction loss can be calculated as below:

$$P_D = (I_{RMS})^2 \times ESR$$

### Output Capacitor Selection

The functions of the output capacitor are to store energy and maintain the output voltage. The low ESR capacitors are preferred to reduce the output ripple voltage ( $\Delta V_{OUT}$ ) and conduction loss. The output ripple voltage can be calculated as below:

$$\Delta V_{OUT} = \Delta I_L \times \left( ESR + \frac{1}{8 \times f_s \times C_{OUT}} \right)$$

Choose suitable capacitors must define the expectative value of output ripple voltage first. A 10uF or 22uF ceramic capacitor with X7R or X5R for most applications is sufficient because of the lower ESR and physical size.

The RMS ripple current flowing through the output capacitor and power dissipation can be calculated as below:

$$I_{RMS} = \frac{\Delta I_L}{\sqrt{12}} = \Delta I_L \times 0.289$$

$$P_D = (I_{RMS})^2 \times ESR$$

The capacitor's ESL (Equivalent Series Inductance) maybe causes ringing in the low MHz region. Choose low ESL capacitors, limiting lead length of PCB and capacitor, and parallel connecting several smaller capacitors to replace with a larger one will reduce the ringing phenomenon.



**Evaluation Board**

**I LA8525**

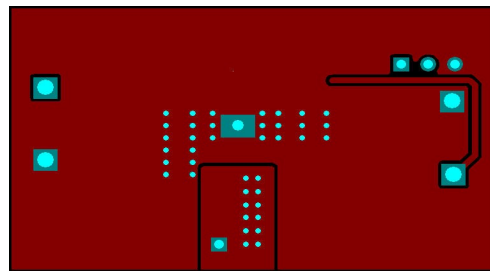
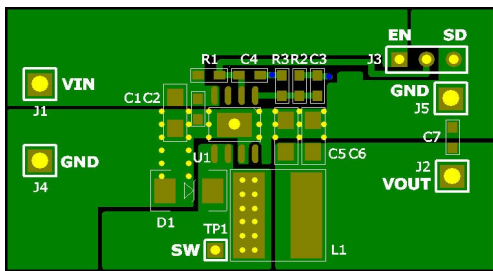
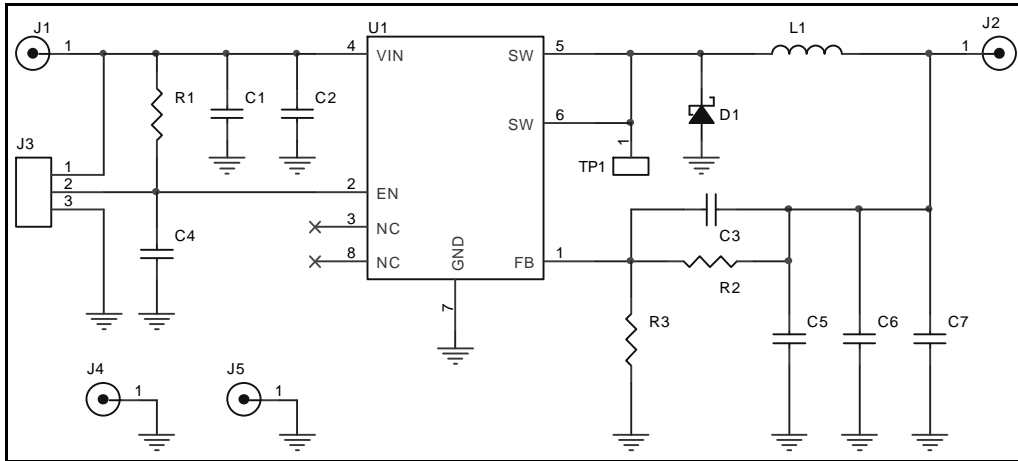

**I LA8525A**

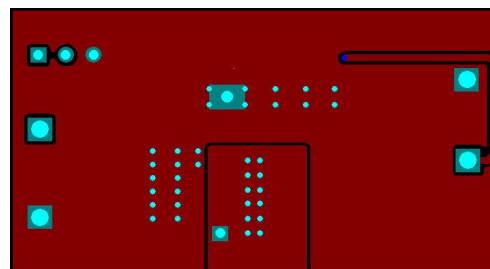
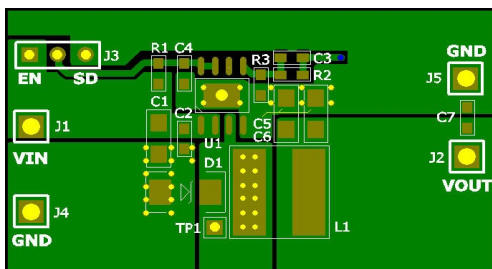
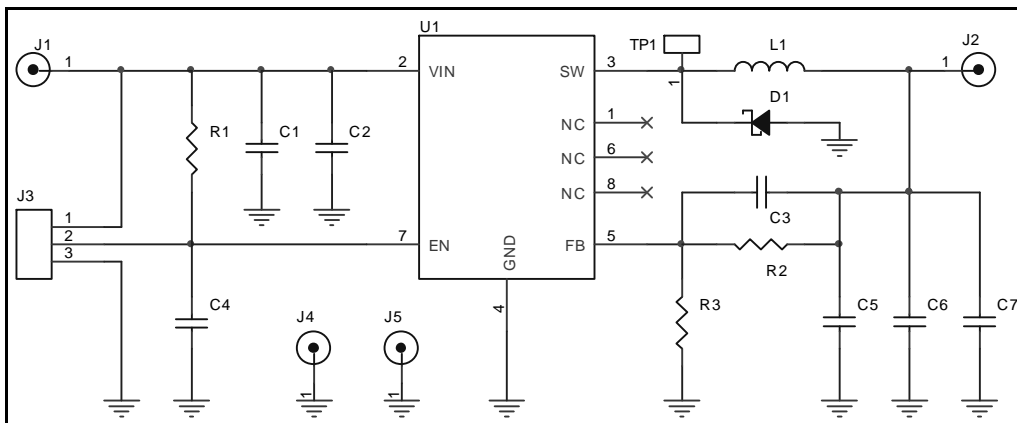

## Key Components Supplier

Item	Manufacturer	Website
Inductor (L)	Taiyo Yuden	<a href="http://www.yuden.co.jp">www.yuden.co.jp</a>
	Chilisin	<a href="http://www.chilisin.com.tw">www.chilisin.com.tw</a>
	TDK	<a href="http://www.tdk.com">www.tdk.com</a>
Schottky Diode (D)	Tiptek	<a href="http://www.tip-tek.com.tw">www.tip-tek.com.tw</a>
	Shindengen	<a href="http://www.shindengen.com">www.shindengen.com</a>
SMD Capacitor (C)	Taiyo Yuden	<a href="http://www.yuden.co.jp">www.yuden.co.jp</a>
	Yageo	<a href="http://www.yageo.com">www.yageo.com</a>
	TDK	<a href="http://www.tdk.com">www.tdk.com</a>
SMD Resistor (R)	Yageo	<a href="http://www.yageo.com">www.yageo.com</a>

## Package Outline

SOP-8

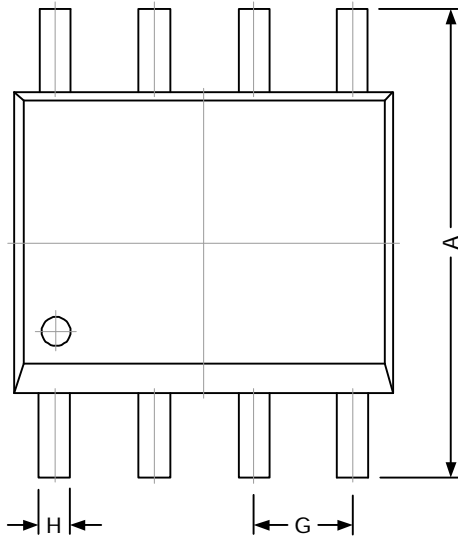

REF.	DIMENSIONS	
	Millimeter	
	Min.	Max.
A	5.80	6.20
B	4.80	5.00
C	3.80	4.00
D	0°	8°
E	0.40	0.90
F	0.19	0.25
M	0.10	0.25
H	0.35	0.49
L	1.35	1.75
J	0.375 REF.	
K	45°	
G	1.27 TYP.	

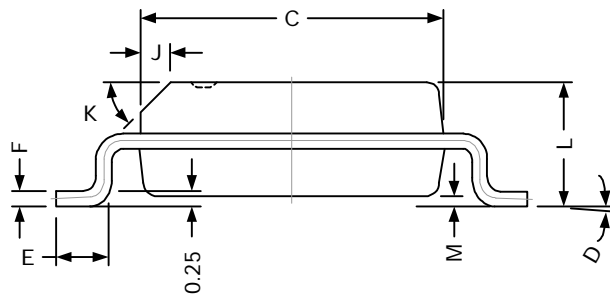
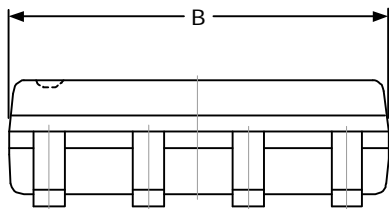

#### *NOTICE*

The specifications and product information of Linear Artwork, Inc. are subject to change without any prior notice, and customer should contact Linear Artwork, Inc. to obtain the latest relevant information before placing orders and verify that such information is current and complete.

The information provided here is believed to be reliable and accurate; however Linear Artwork, Inc. makes no guarantee for any errors that appear in this document.

#### *LIFE SUPPORT POLICY*

Linear Artwork products are not designed or authorized for use as critical components in life support devices or systems without the express written approval of the president of Linear Artwork, Inc. As used herein:

1. Life support devices or systems are devices or systems which, (a) are intended for surgical implant into the body, or (b) support or sustain life, and (c) whose failure to perform when properly used in accordance with instructions for use provided in the labeling, can be reasonably expected to result in a significant injury of the user.
2. A critical component in any component of a life support device or system whose failure to perform can be reasonably expected to cause the failure of the life support device or system, or to affect its safety or effectiveness.