



LB11820M

Direct PWM Drive Brushless Pre-Driver for Household Appliance Motors

Overview

The LB11820M is a direct PWM drive pre-driver IC that is appropriate for 3-phase power brushless motors. This IC can implement motor driver circuits that provide the desired output capabilities (voltage and current) by the use of appropriate discrete transistors in the output circuit. The LB11820M is optimal for driving the large motors used in air conditioners and on-demand hot water heaters.

Functions and Features

- Three-phase bipolar drive
- Direct PWM drive
- Built-in braking function (Short braking)
- Forward/reverse switching function
- Reverse motion mode protection circuit
- Full complement of protection circuits, include current limiter, low-voltage protection, and motor constraint (rotor locking) protection circuits
- Supports control from either a command voltage or a PWM duty input.

Package Dimensions

unit: mm

3073C-MFP30SD (375mil)

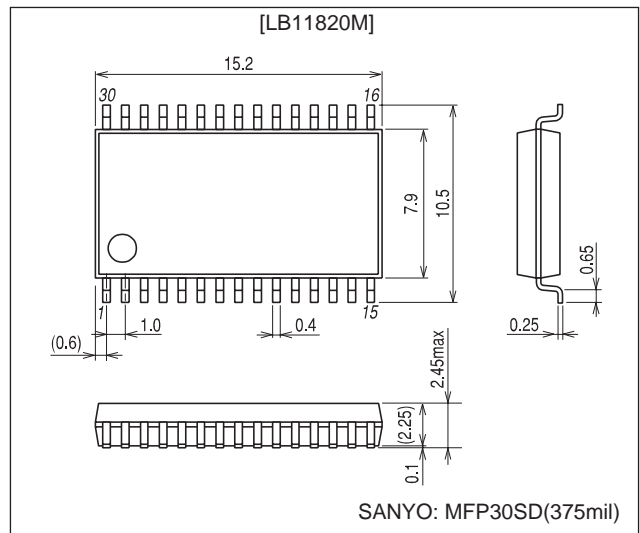

Specifications

Absolute Maximum Ratings at Ta = 25°C

Parameter	Symbol	Conditions	Ratings	Unit
Maximum supply voltage 1	V _{CC 1 max}	V _{CC 1}	14.5	V
Maximum supply voltage 2	V _{CC 2 max}	V _{CC 2}	14.5	V
Maximum supply voltage 3	V _{CC 3 max}	V _{CC 3}	20	V

Continued on next page.

■ Any and all SANYO products described or contained herein do not have specifications that can handle applications that require extremely high levels of reliability, such as life-support systems, aircraft's control systems, or other applications whose failure can be reasonably expected to result in serious physical and/or material damage. Consult with your SANYO representative nearest you before using any SANYO products described or contained herein in such applications.

■ SANYO assumes no responsibility for equipment failures that result from using products at values that exceed, even momentarily, rated values (such as maximum ratings, operating condition ranges, or other parameters) listed in products specifications of any and all SANYO products described or contained herein.

LB11820M

Continued from preceding page.

Parameter	Symbol	Conditions	Ratings	Unit
Maximum output current	I_O max	The UL, VL, WL, UH, VH, and WH pins	40	mA
Maximum RF pin applied voltage	VRF max		4	V
Maximum LVS pin applied voltage	VLVS max		20	V
Maximum TOC pin applied voltage	VTOC max		V_{CC2}	V
Maximum VCTL pin applied voltage	VCTL max		14.5	V
Allowable power dissipation	P_d max	Independent IC	0.9	W
Operating temperature	T_{opr}		-20 to +100	°C
Storage temperature	T_{stg}		-55 to +150	°C

Allowable Operating Ranges at $T_a = 25^\circ\text{C}$

Parameter	Symbol	Conditions	Ratings	Unit
Supply voltage range 1-1	V_{CC1-1}	V_{CC1}	8 to 13.5	V
Supply voltage range 1-2	V_{CC1-2}	V_{CC1} , with V_{CC1} and VREG shorted together	4.5 to 5.5	V
Supply voltage range 2	V_{CC2}	V_{CC2}	4.5 to V_{CC1}	V
Supply voltage range 3	V_{CC3}	V_{CC3}	13.5 to 19	V
Output current	I_O	The UL, VL, WL, UH, VH, and WH pins	30	mA
12 V regulator voltage output current	I12REG		-50	mA
5 V regulator voltage output current	IREG		-20	mA
HP pin applied voltage	VHP		0 to 13.5	V
HP pin output current	IHP		0 to 10	mA

Electrical Characteristics at $T_a = 25^\circ\text{C}$, $V_{CC1} = 12\text{ V}$, $V_{CC2} = V_{REG}$

Parameter	Symbol	Conditions	Ratings			Unit
			min	typ	max	
Supply current 1	I_{CC1-1}			15	20	mA
Supply current 2	I_{CC1-2}	When stopped		2.5	4	mA
[Output Block]						
Output voltage 1-1	V_{OUT1-1}	Low level, $I_O = 400\ \mu\text{A}$		0.1	0.3	V
Output voltage 1-2	V_{OUT1-2}	Low level, $I_O = 10\ \text{mA}$		0.8	1.1	V
Output voltage 2	V_{OUT2}	High level, $I_O = -20\ \text{mA}$	$V_{CC1} - 1.1$	$V_{CC1} - 0.9$		V
Temperature coefficient 1-1	ΔV_{OUT1-1}	Design target value*, low level, $I_O = 400\ \mu\text{A}$		0.2		mV / °C
Temperature coefficient 1-2	ΔV_{OUT1-2}	Design target value*, low level, $I_O = 10\ \text{mA}$		-1.5		mV / °C
Temperature coefficient 2	ΔV_{OUT2}	Design target value*, high level, $I_O = -20\ \text{mA}$		1.5		mV / °C
[12 V Voltage Output (12REG pin)]						
Output voltage	V12REG	$V_{CC3} = 15\ \text{V}$, $I_O = -30\ \text{mA}$	11.7	12.1	12.6	V
Line regulation	ΔV_{12REG1}	$V_{CC3} = 13.5$ to $19\ \text{V}$, $I_O = -30\ \text{mA}$		150	300	mV
Load regulation	ΔV_{12REG2}	$I_O = -5$ to $-45\ \text{mA}$, $V_{CC3} = 15\ \text{V}$		100	200	mV
Temperature coefficient	ΔV_{12REG3}	Design target value*		2		mV / °C
[5 V Voltage Output (VREG pin)]						
Output voltage	VREG		4.7	5.0	5.3	V
Line regulation	ΔV_{REG1}	$V_{CC1} = 8$ to $13.5\ \text{V}$		40	100	mV
Load regulation	ΔV_{REG2}	$I_O = -5$ to $-20\ \text{mA}$		5	30	mV
Temperature coefficient	ΔV_{REG3}	Design target value*		0		mV / °C
[Hall Amplifier Block]						
Input bias current	IHB(HA)		-2	-0.5		μA
Common-mode input voltage range 1	VICM1	When Hall effect devices are used	0.5		$V_{CC1} - 2.0$	V
Common-mode input voltage range 2	VICM2	When single-sided input bias is used (Hall IC application)	0		V_{CC1}	V
Hall input sensitivity			50			mVp-p
Hysteresis	$\Delta V_{IN(HA)}$		20	30	50	mV
Input voltage low→high	VSLH(HA)		5	15	25	mV
Input voltage high→low	VSHL(HA)		-25	-15	-5	mV

* : These are design target values and are not tested.

Continued on next page.

LB11820M

Continued from preceding page.

Parameter	Symbol	Conditions	Ratings			Unit
			min	typ	max	
[VCTL Pin]						
Input voltage 1	VCTL1	Output duty : 0%	1.05	1.4	1.75	V
Input voltage 2	VCTL2	Output duty : 100%	3.0	3.5	4.1	V
Input bias current 1	IB1(CTL)	VCTL = 0 V	-80	-60		μA
Input bias current 2	IB2(CTL)	VCTL = 5 V		60	80	μA
[PWM Oscillator (PWM pin)]						
High-level output voltage	V _{OH} (PWM)		2.75	3.0	3.25	V
Low-level output voltage	V _{OL} (PWM)		1.0	1.2	1.3	V
External capacitor charge current	ICHG	VPWM = 2.1 V	-60	-45	-30	μA
Oscillator frequency	f(PWM)	C = 1000pF	17.6	22	26.8	kHz
Amplitude	V(PWM)		1.6	1.8	2.1	Vp-p
[TOC pin]						
Input voltage 1	VTOC1	Output duty : 0%	2.72	3.0	3.30	V
Input voltage 2	VTOC2	Output duty : 100%	0.99	1.2	1.34	V
Input voltage 1L	VTOC1L	Design target value*, when V _{CC2} = 4.7 V, 0%	2.72	2.80	2.90	V
Input voltage 2L	VTOC2L	Design target value*, when V _{CC2} = 4.7 V, 100%	0.99	1.08	1.17	V
Input voltage 1H	VTOC1H	Design target value*, when V _{CC2} = 5.3 V, 0%	3.08	3.20	3.30	V
Input voltage 2H	VTOC2H	Design target value*, when V _{CC2} = 5.3 V, 100%	1.11	1.22	1.34	V
[HP pin]						
Output saturated voltage	VHPL	I _O = 7 mA		0.15	0.5	V
Output leakage current	IHP leak	V _O = 13.5 V			10	μA
[CSD Oscillator (CSD pin)]						
High-level output voltage	V _{OH} (CSD)		3.2	3.6	4.0	V
Low-level output voltage	V _{OL} (CSD)		0.9	1.1	1.3	V
External capacitor charge current	ICHG1		-14	-10	-6	μA
External capacitor discharge current	ICHG2		7	11	15	μA
Oscillator frequency	f(CSD)	C = 0.01 μF		200		Hz
Amplitude	V(CSD)		2.2	2.5	2.75	Vp-p
[Current Limiter Circuit (RF pin)]						
Limiter voltage	VRF		0.45	0.5	0.55	V
[Low-Voltage Protection Circuit (LVS pin)]						
Operating voltage	VSDL		3.6	3.8	4.0	V
Release voltage	VSDH		4.1	4.3	4.5	V
Hysteresis	ΔVSD		0.35	0.5	0.65	V
[Thermal Shutdown Circuit (Thermal protection circuit)]						
Thermal shutdown temperature	TSD	Design target value* (Junction temperature)	125	145	165	°C
Hysteresis	ΔTSD	Design target value* (Junction temperature)	20	25	30	°C
[PWMIN Pin]						
Input frequency	f(PI)				50	kHz
High-level input voltage	V _{IH} (PI)		2.0		VREG	V
Low-level input voltage	V _{IL} (PI)		0		1.0	V
Input open voltage	V _{IO} (PI)		VREG - 0.5		VREG	V
Hysteresis	V _{IS} (PI)		0.2	0.3	0.4	V
High-level input current	I _{IH} (PI)	VPWMIN = VREG	-10	0	10	μA
Low-level input current	I _{IL} (PI)	VPWMIN = 0 V	-130	-96		μA
[S/S Pin]						
High-level input voltage	V _{IH} (SS)		2.0		VREG	V
Low-level input voltage	V _{IL} (SS)		0		1.0	V
Input open voltage	V _{IO} (SS)		VREG - 0.5		VREG	V
Hysteresis	V _{IS} (SS)		0.2	0.3	0.4	V
High-level input current	I _{IH} (SS)	VS/S = VREG	-10	0	10	μA
Low-level input current	I _{IL} (SS)	VS/S = 0 V	-130	-96		μA

* : These are design target values and are not tested.

Continued on next page.

LB11820M

Continued from preceding page.

Parameter	Symbol	Conditions	Ratings			Unit
			min	typ	max	
[F/R Pin]						
High-level input voltage	$V_{IH}(FR)$		2.0		VREG	V
Low-level input voltage	$V_{IL}(FR)$		0		1.0	V
Input open voltage	$V_{IO}(FR)$		VREG - 0.5		VREG	V
Hysteresis	$V_{IS}(FR)$		0.2	0.3	0.4	V
High-level input current	$I_{IH}(FR)$	$V_{F/R} = V_{REG}$	-10	0	10	μA
Low-level input current	$I_{IL}(FR)$	$V_{F/R} = 0 V$	-130	-96		μA
[BR Pin]						
High-level input voltage	$V_{IH}(BR)$		2.0		VREG	V
Low-level input voltage	$V_{IL}(BR)$		0		1.0	V
Input open voltage	$V_{IO}(BR)$		VREG - 0.5		VREG	V
Hysteresis	$V_{IS}(BR)$		0.2	0.3	0.4	V
High-level input current	$I_{IH}(BR)$	$V_{B/R} = V_{REG}$	-10	0	10	μA
Low-level input current	$I_{IL}(BR)$	$V_{B/R} = 0 V$	-130	-96		μA
[REVSEL Pin]						
High-level input voltage	$V_{IH}(RSEL)$		2.0		VREG	V
Low-level input voltage	$V_{IL}(RSEL)$		0		1.0	V
Input open voltage	$V_{IO}(RSEL)$		VREG - 0.5		VREG	V
High-level input current	$I_{IH}(RSEL)$	$V_{REVSEL} = V_{REG}$	-10	0	10	μA
Low-level input current	$I_{IL}(RSEL)$	$V_{REVSEL} = 0 V$	-130	-96		μA

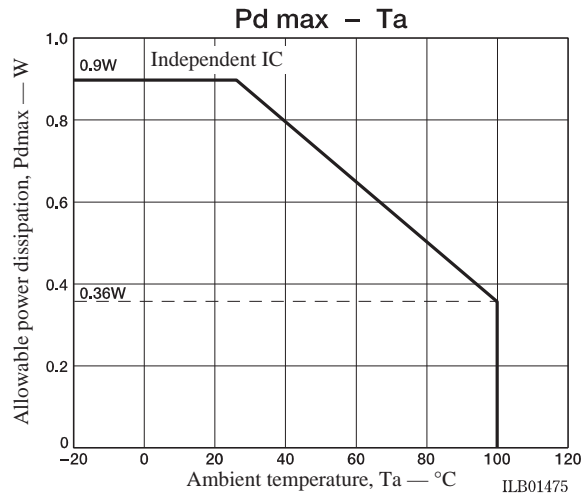

Three-Phase Logic Truth Table (IN = "H" refers to the state where IN+ > IN-.)

	F / R = (L)			F / R = (H)			Output	
	IN1	IN2	IN3	IN1	IN2	IN3	PWM	-
1	H	L	H	L	H	L	VH	UL
2	H	L	L	L	H	H	WH	UL
3	H	H	L	L	L	H	WH	VL
4	L	H	L	H	L	H	UH	VL
5	L	H	H	H	L	L	UH	WL
6	L	L	H	H	H	L	VH	WL

When the OFF mode is selected during reversing at the REVSEL pin, it is necessary to specify the Hall input condition.

With F/R = "L", the condition in which the Hall input is entered in the order from 1 to 6 in the above table is considered the forward rotation and that in the reverse order is considered reversing.

With F/R = "H", the condition in which the Hall input is entered in the order from 6 to 1 in the above table is considered the forward rotation and that in the reverse order is considered reversing.

S/S Pin

Input state	State
High or open	Stop
Low	Start

REVSEL Pin

Input state	State
High or open	-
Low	Off in reverse

BR Pin

Input state	State
High or open	-
Low	Brake

PWIM Pin

Input state	State
High or open	Output off
Low	Output on

When S/S and PWMIN pins are not used, set the input to the L level voltage.

When REVSEL and BR pins are not used, set the input to the H level voltage or the open condition.

LB11820M

Pin Assignment

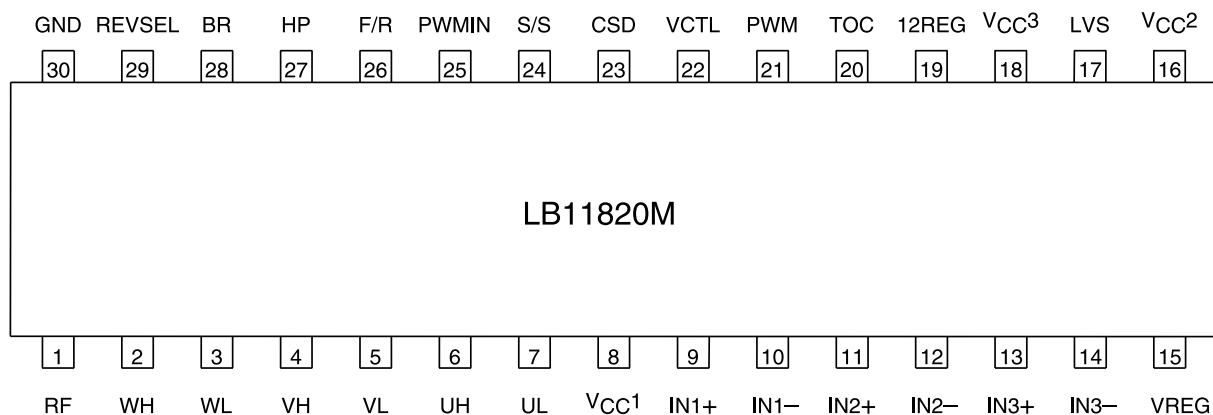

Top view

Pin No.	Pin	Function	Equivalent circuit
1	RF	Output current detection Connect a resistor (Rf) between this pin and ground. Set with the maximum output current $I_{OUT} = 0.5/R_f$.	
2 4 6 3 5 7	WH VH UH WL VL UL	Output pin (external TR drive output) Duty control made on UH, VH, and WH sides.	
8	V _{CC1}	Power supply (output and Hall input blocks). Normally used with the 12 V power supply. Connect to V _{CC2} and VREG for application with the 5 V single power supply. Connect a capacitor between this pin and GND for stabilization.	

Continued on next page.

LB11820M

Continued from preceding page.

Pin No.	Pin	Function	Equivalent circuit
9 10 11 12 13 14	IN1+ IN1- IN2+ IN2- IN3+ IN3-	Hall amplifier input. IN+ > IN- is the input high state, and the reverse is the input low state. Connect a capacitor between the sIN+ and IN- inputs if there is noise in the Hall sensor signals.	
15	VREG	Regulated-voltage output pin (5V output) Connect a capacitor (about 0.1 μF) between this pin and ground for stabilization.	
16	VCC2	Power pin (PWM oscillation, PWM comparator, VCTL amp). Normally connect to VREG.	
17	LVS	Voltage detection pin for low-voltage protection. To detect the supply voltage of 5 V or more, connect the zenor diode in series to set the detection voltage.	
18 19	VCC3 12REG	Power pin (VCC3) for use during application with the supply voltage of 12 V or more. 12 V is generated at the 12 REG pin. To use the 12REG pin, connect this pin to VCC1. When not used, keep both VCC3 and 12 REG open or connect them to GND.	
20	TOC	PWM waveform comparator pin. Normally used in the open condition. By inputting the voltage directly into this pin, the output duty can be controlled without using the VCTL amp.	

Continued on next page.

LB11820M

Continued from preceding page.

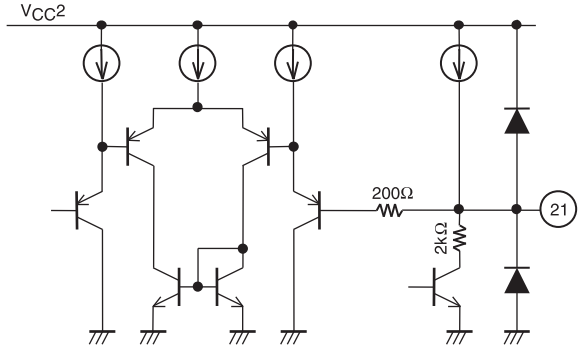
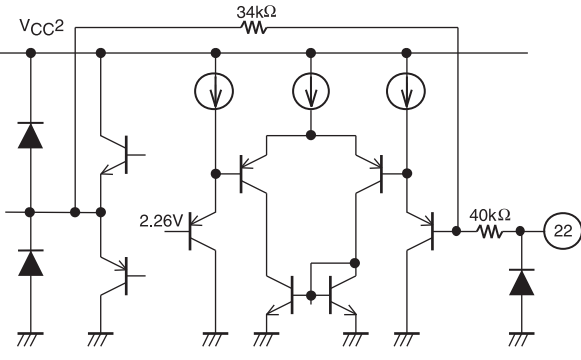
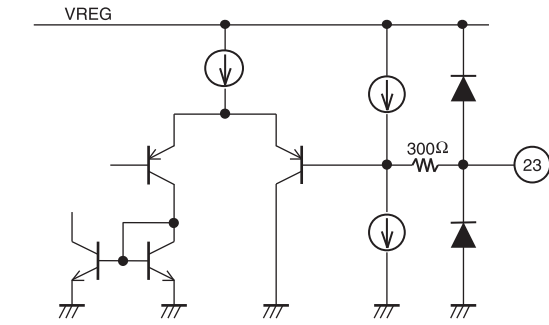
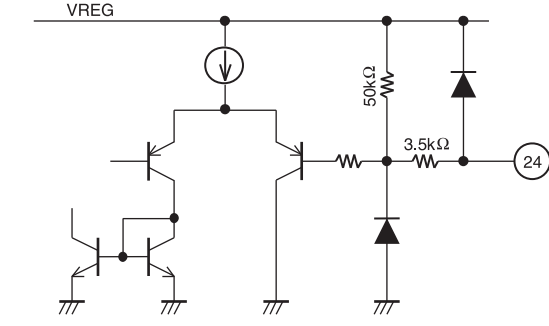
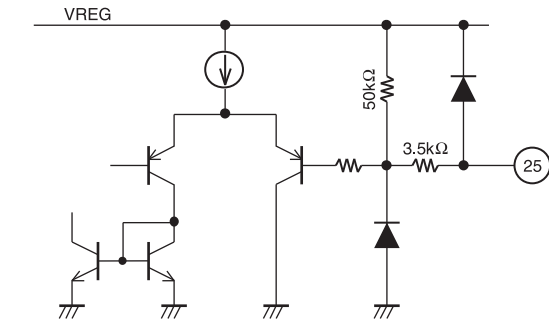
Pin No.	Pin	Function	Equivalent circuit
21	PWM	Pin to set the PWM oscillation frequency. Connect a capacitor between this pin and GND.	
22	VCTL	Control voltage input pin. For control with this pin, set the PWMIN pin to the L level.	
23	CSD	Pin to set the operation time of motor lock protection circuit and to set the initial reset pulse. Connect a capacitor between this pin and GND. When the protection circuit is not to be used, connect a capacitor and resistor (150 kΩ, 4700 pF) in parallel between this pin and GND.	
24	S / S	Start/stop control pin. Start with L and stop with H or in the open condition.	
25	PWM IN	PWM pulse input pin. Output drive with L and output OFF with H or in the open condition. For control with this pin, apply the voltage of VCTL2 voltage or more to the VCTL pin.	

Continued on next page.

LB11820M

Continued from preceding page.

Pin No.	Pin	Function	Equivalent circuit
26	F / R	Forward/reverse input pin	
27	HP	Hall signal three-phase synthesis output signal	
28	BR	Brake input pin. Brake with L and normal rotation with H or in the open condition.	
29	REV SEL	Reverse OFF selector pin. Effective with L and ineffective with H or in the open condition.	
30	GND	GND pin	

Hall Signal Input/Output Timing Charts

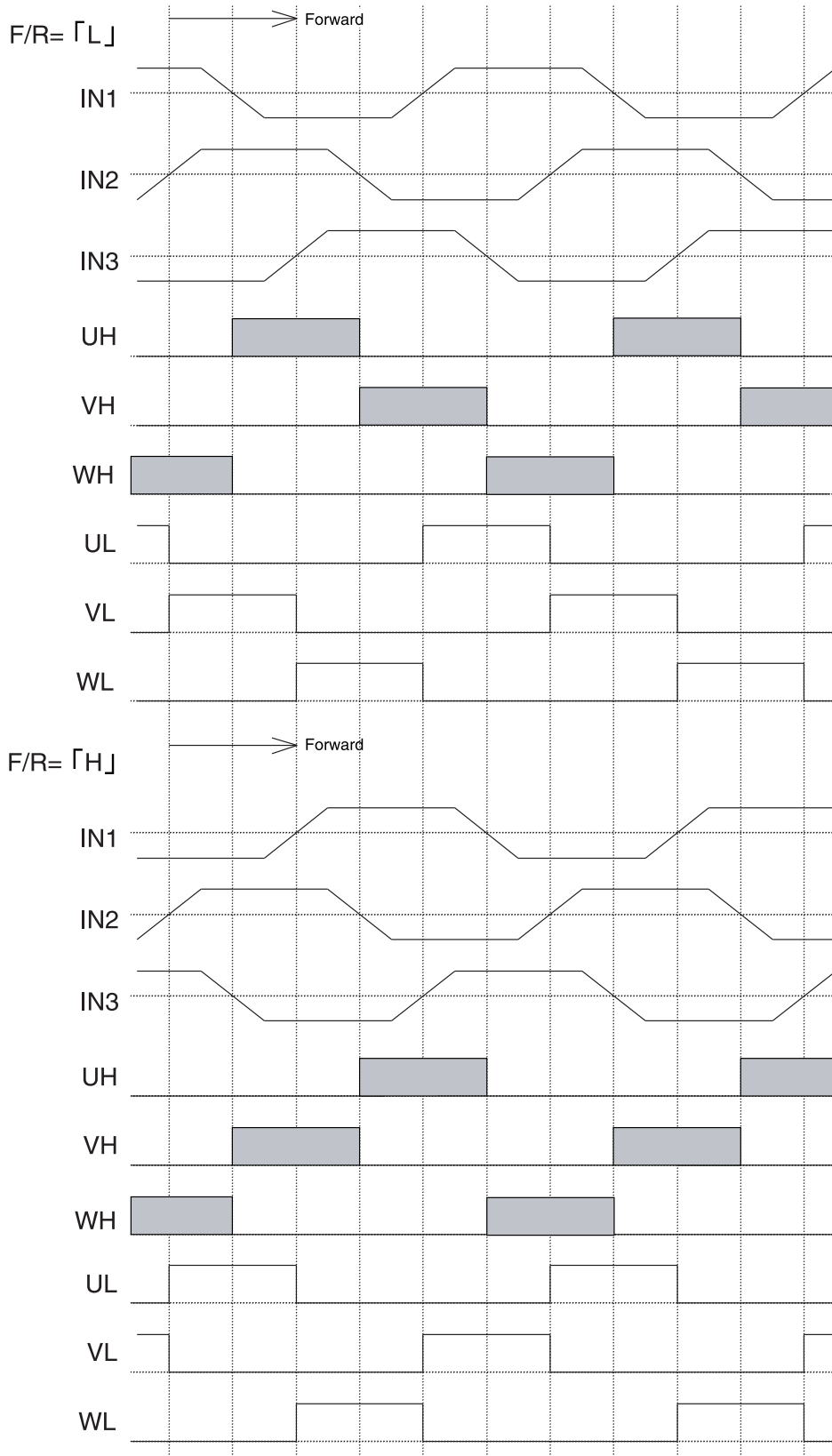

 The shaded areas indicate PWM output.

Sample Application Circuit

BIP Transistor Drive (upper side PWM) Using a 5 V Power Supply

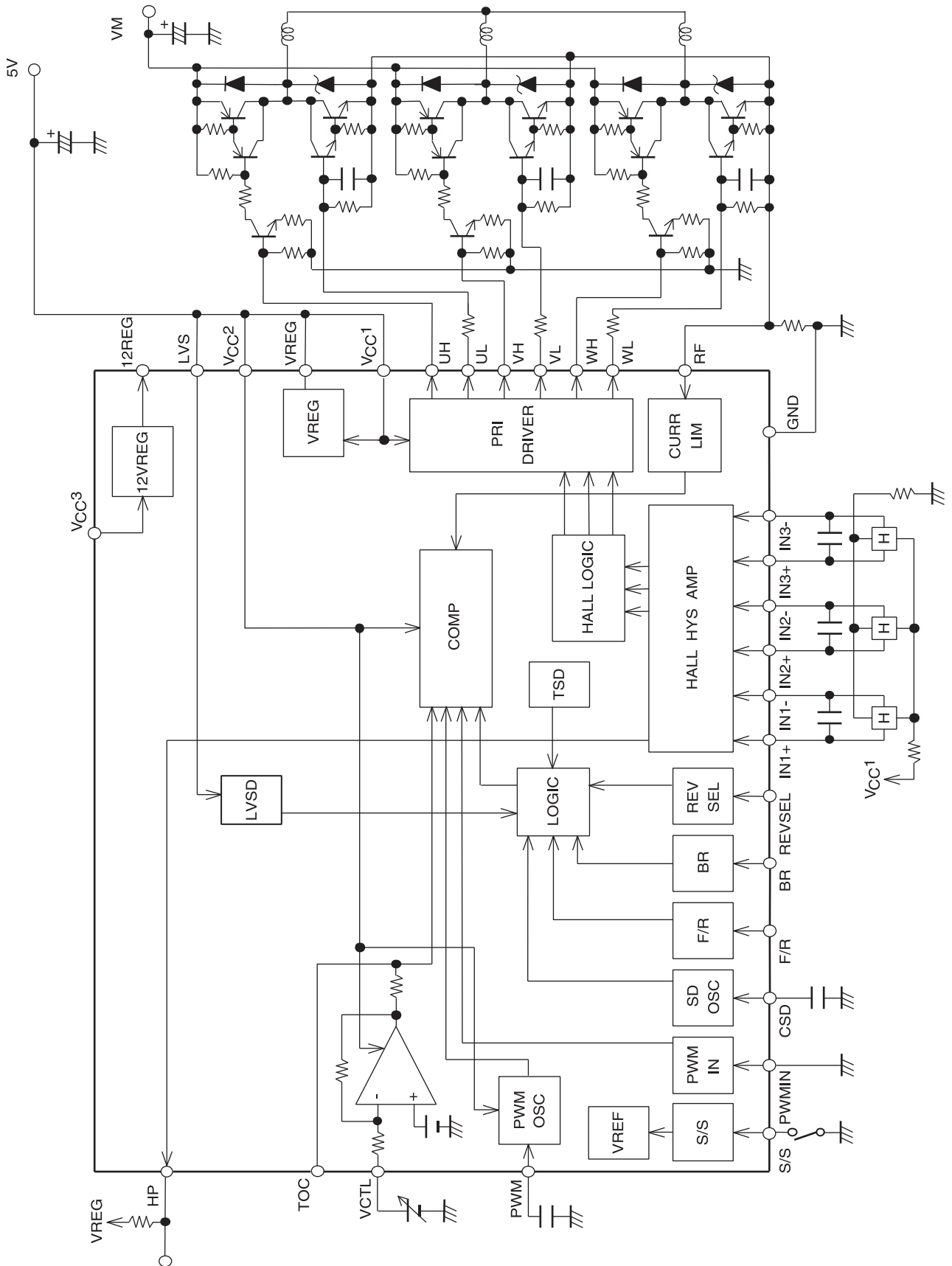

Functional Description

1. Output Drive Circuit

This IC employs a direct PWM drive method to minimize the power loss at output. The output TR is normally saturated in the ON condition, adjusting the motor drive power by changing the output on-duty. Output PWM switching is made on UH, VH, and WH output sides. Since UL – WL and UH – WH outputs are of the same output form, either lower PWM or upper PWM can be selected by changing the external output Tr connection method. Selection of diode to be connected to the non-PWM side output requires attention because there is a problem of reverse recovery time. (Unless a diode with the short reverse recovery time is selected, the through current flows in an instant when the PWM side Tr is turned ON.)

UL – WL and UH – WH outputs enter the high impedance condition at a time of stop or when the supply voltage is extremely low (below the allowable operation voltage). Accordingly, an appropriate measure (pull-down resistor, etc.) is necessary in the external circuit to prevent an incorrect action due to the leak current.

2. Current Limiting Circuit

The current limiting circuit performs limiting with the current determined from $I = V_{RF}/R_f$ ($V_{RF} = 0.5 \text{ V}_{typ}$, R_f :current detector resistance) (that is, this circuit limits the peak current).

Limiting operation includes decrease in the output on-duty to suppress the current.

The current limiting circuit incorporates a filter circuit to prevent an incorrect action of current limiting operation due to detection of the reverse recovery current of output diode during PWM operation. This internal filter circuit will be enough to prevent trouble for normal application. In case of an incorrect action (diode reverse recovery current flowing for 1 μs or more), add an external filter circuit (R, C low pass filter, etc.).

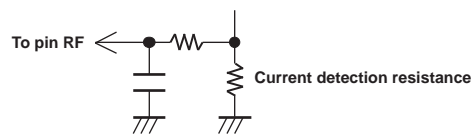

3. Power Save Circuit

This IC enters the power save condition to decrease the current dissipation in the stop mode. In this condition, the bias current of most of circuits is cut off. Even in the power save condition, the 5 V regulator output (VREG) is given. If the bias current of Hall device is to be cut, 5 V and Hall device may be connected via PNP Tr as a means to meet such needs.

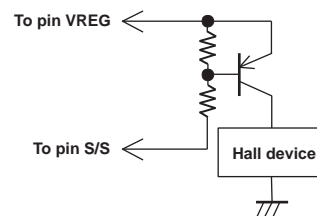

4. Compatibility with Various Power Supplies

To operate this IC with external 5 V power supply (4.5 – 5.5 V), short-circuit V_{CC1} and VREG pin for connection to power supply.

To operate this IC with external 12 V power supply (8 – 13.5 V), connect power supply to V_{CC1} (5 V is generated at the VREG pin to function as a power supply to the control circuit).

To operate this IC with external 15 V power supply (13.5 – 19 V), connect power supply to V_{CC3} and short-circuit 12REG and V_{CC1} pins (12 V is generated at the 12REG pin to function as a power supply to V_{CC1}).

Connect the V_{CC2} pin basically to the VREG pin. In an application in which the motor rotation speed is to be determined by the external fixed voltage (resistor division, etc.), set V_{CC2} to 12 V (by connecting to V_{CC1}) to suppress variation of the output duty. (Variation of IC is difficult to affect adversely because of increase in the PWM oscillation amplitude and in the comparator dynamic range.)

5. PWM Frequency

PWM frequency is determined from the capacity C (F) of capacitor connected to the PWM pin.

$$f_{\text{PWM}} \approx 1 / (45000 \times C)$$

Connection of a 1000 pF capacitor causes oscillation of about 22 kHz. Excessively low PWM frequency causes a switching sound from the motor while excessively high PWM frequency causes increase in the power loss at the output. About 15 – 50 kHz is recommended. Capacitor GND should be arranged near the IC GND pin as much as possible to protect from the effect of output noise.

6. Drive Method

The output duty can be controlled according to any of following methods.

- Control with the VCTL pin voltage

For the control voltage, refer to the electric characteristics. For control with the VCTL pin, set the PWMIN pin voltage to the L level.

- Control with the voltage applied to the TOC pin

The TOC pin voltage and PWM oscillation waveform are compared to determine the output duty. The output duty becomes 0 % when the TOC pin voltage exceeds V_{OH} (PWM) (3.0 V typ) and 100% when it becomes lower than the V_{OL} (PWM) (1.2 V typ). For control with the TOC pin, set the PWMIN pin voltage to the L level.

For control with the input level other than the internal CTL amp control input level, external connection of amp allows setting to the arbitrary input level (with the external amp output connected to the TOC pin). For control from the TOC pin, fix the VCTL pin voltage.

For an application in which the regulated voltage is applied to the TOC pin through resistor division, etc., it is necessary to take into account the effect of resistor (about 20 k Ω) incorporated between the TOC pin and CTL amp output. (Variation about $\pm 20\%$, temperature characteristics about $+0.3\%/^{\circ}\text{C}$). If the noise is included in the voltage to be applied to the TOC pin, chattering may occur in the output. In this case, stabilization with a capacitor is necessary.

- Pulse control with the PWMIN pin

The output can be controlled on the basis of duty obtained by entering the pulse in the PWMIN pin. The output can be turned ON when the L-level input voltage is applied to the PWM pin and OFF when the H-level input voltage is applied. With the PWMIN pin open, the output becomes the H level and is turned OFF. If input with reversed logic is necessary, addition of external Tr (NPN) may be enough.

For control with the PWMIN pin, set the VCTL pin voltage that is more than the VCTL2 voltage (output duty set to 100%) or connect the TOC pin to GND.

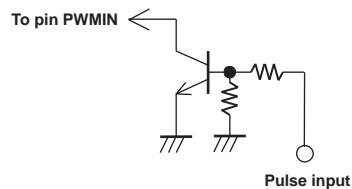

7. Hall Input Signal

The Hall input requires the signal input with an amplitude exceeding the hysteresis width (50 mV max). Considering the effect of noise and phase displacement, the input with the amplitude of 120 mV or more is recommended.

When the noise causes disturbance in the output waveform (at a time of phase change) or HP output (Hall signal three-phase synthesis output), insert a capacitor to the input to prevent such trouble. The Hall input is used as a signal to determine the input to the restriction protection circuit and the protection circuit during reverse. Though noise is ignored to a certain degree, due attention must be paid when using these protection circuits.

When all three phases of Hall input signal are entered, the output is turned OFF entirely (all of UL, VL, WL, UH, VH, and WH OFF).

To enter the Hall IC output, fix one side of input (+ or -) to the voltage within the common-mode input range for Hall device. This will allow input from 0 to V_{CC1} for another single-side input.

8. Circuit for Low-Voltage Protection

This circuit detects the voltage applied to the LVS pin. When this voltage drops below the operation voltage (see the electric characteristics), the one-side output (UH, VH, and WH) is turned OFF. To prevent repetition of output ON/OFF near the protection activation voltage, the hysteresis is provided. Accordingly, the output is not recovered unless the voltage rises by about 0.5 V above the activation voltage.

The protection activation voltage is for the 5 V system detection level. The detection level can be raised by connecting the zenor diode in series to the LVS pin and by shifting the detection level. The LVS pin inrush current at a time of detection is about 65 μA . To stabilize rise of the zenor diode voltage, increase the diode current by inserting the resistor between the LVS pin and GND.

When the protection circuit is not used, apply a voltage on a level where the protection is not activated, instead of setting the LVS pin open (output OFF with the pin open).

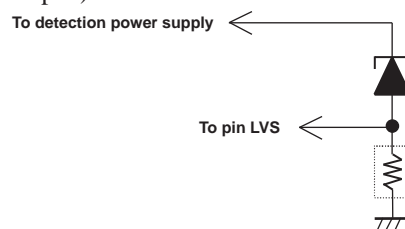

9. Motor Lock Protection Circuit

A motor lock protection circuit is incorporated for protection of IC and motor when the motor is locked. When the Hall input signal is not changed for a certain period with the motor driving, the one-side output (UH, VH, WH) is turned OFF. The time is set by means of a capacity of a capacitor connected to the CSD pin.

$$\text{Set time (s)} \approx 154 \times C (\mu\text{F})$$

Addition of a 0.01 μF capacitor causes a protection time of about 1.54 seconds. (Drive is turned OFF when one cycle of Hall input signal is longer than this time period.) The time to be set must have a sufficient allowance so that the protection is not activated at a normal motor startup. Select the capacitor of 4700 pF or more. The protection circuit is not activated when braking. To cancel the restriction protection condition, one of following steps must be taken:

- Stop mode (10 μs or more)
- Maintaining the output duty 0% condition through input of VCTL or PWMIN for more than the period of $t_{\text{CSD}} \times 2$. ($t_{\text{CSD}}(\text{s}) \approx 0.5 \times C (\mu\text{F})$. When the 0.01 μF capacitor is added, maintaining for about 10 ms or more is necessary.)
- Re-application of power supply

The CSD pin acts also as an initial reset pulse generation pin and causes reset of the logic circuit when connected with GND. Accordingly, the motor drive condition can not be obtained. When this pin is not to be used, a resistor of about 150 k Ω and a capacitor of about 4700 pF must be connected to GND in parallel. When the restriction protection circuit is not used, following functions are also invalid:

- Protection circuit for the reverse mode
- Overheat protection circuit

10. Protection Circuit at Reverse

This circuit becomes effective when the REVSEL pin is set to the L level. When this protection is not necessary, either connect it to the VREG pin or keep it open.

When this circuit is effective, all outputs are OFF (all of UL, VL, WL, UH, VH, and WH OFF) when the drive is OFF (output duty 0%). If the condition is switched rapidly from the output drive condition to the drive OFF condition, the current flowing through the motor is returned to the power supply (the coil current flows through output upper and lower diodes to power supply). If this current causes a trouble, such as rise of the supply voltage, etc., it is necessary to reduce the duty in steps, instead of shutting of the drive suddenly.

Reverse condition is detected according to the input sequence of Hall signals (IN1, IN2, and IN3). When using this protection circuit, it is necessary to connect the Hall device with motor while considering the Hall input sequence. (See the three-phase logic truth table.) Reversing is judged when the Hall input is reversed by more than 120 degrees in the electrical angle. The drive is not shut OFF immediately after judgment of reverse, but the drive is continued for a certain period (equal to the motor lock protection set time) after drive start. If the reversing condition continues for a certain period (equal to the set time of motor lock protection), the drive is shut OFF (all OFF).

When the motor is reversing before it is driven, the drive is continued for a certain period (equal to the set time of motor lock protection). If the motor does not return to forward rotation within this period, the drive is shut OFF (all OFF).

To cancel the protection, one of following steps must be taken:

- Stop mode (10 μs or more)
- Maintaining the output duty 0% condition through input of VCTL or PWMIN for more than the period of $t_{\text{CSD}} \times 2$. ($t_{\text{CSD}}(\text{s}) \approx 0.5 \times C (\mu\text{F})$. When the 0.01 μF capacitor is added, maintaining for about 10 ms or more is necessary.)
- Re-application of power supply

11. Overheat Protection Circuit

One-side output (UH, VH, WH) is turned OFF when the junction temperature (T_j) exceeds a specified temperature (TSD). Since the minimum variation of TSD is 125 $^{\circ}\text{C}$, thermal design must be made so that $T_j = 125^{\circ}\text{C}$ is not exceeded except in the case of abnormality. Accordingly, P_{dmax} when $T_j(\text{max}) = 125^{\circ}\text{C}$ is 0.72 W ($T_a = 25^{\circ}\text{C}$).

When the motor lock protection is not to be used by inserting in parallel the resistor of about 150 k Ω and capacitor of about 4700 pF between the CSD pin and GND, this overheat protection circuit does not function.

In this case, $T_j(\text{max}) = 150^{\circ}\text{C}$, so that $P_{\text{dmax}} = 0.9 \text{ W}$ ($T_a = 25^{\circ}\text{C}$).

12. Forward/Reverse Rotation

To select forward or reverse in the rotation condition, a measure is taken to prevent flow of the through current (through current due to the output Tr OFF delay time at selection) at the output. Selection during rotation causes the current exceeding the current limit value to flow through the output Tr because of the motor coil resistance and motor reverse electromotive voltage condition. It is therefore necessary to select the external output Tr that is not damaged by this current or to select forward/reverse only when the motor rotation speed has decreased to a certain level.

13. Brake operation

Braking is made by setting the BR pin to the L level. Braking consists of a short-circuit brake condition in which all of one-side outputs (UH, VH, or WH) are turned ON while other outputs (UL, VL, WL) are turned OFF. A measure is taken to prevent flow of through current (through current due to output Tr OFF delay time at selection) when the brake is operated or cancelled. While braking is made, current limiting and motor lock protection circuits are not operative.

Short-circuit braking causes large current to flow through the output Tr because of motor coil resistance and the motor reverse electromotive voltage condition during operation. It is therefore necessary to select the external output Tr that is not damaged by this current or to activate braking only when the motor rotation speed has decreased to a certain level.

14. Power Supply Stabilization

This IC is of a switching drive type and the power line tends to be affected. It is therefore necessary to connect a capacitor of sufficient capacity for stabilization between the V_{CC1} pin and GND.

To insert a diode in the power line to prevent breakdown through reverse connection of power supply, the power line becomes more readily affected. It is necessary to select a larger capacity.

To turn ON/OFF the power supply with a switch, etc., large distance between the switch and capacitor causes substantial deviation of the supply voltage due to the line inductance and inrush current into the capacitor. In certain cases, the withstand voltage may be exceeded. In this case, do not use a ceramic capacitor whose series impedance is low. Instead, use an electrolytic capacitor to suppress the inrush current and to prevent voltage rise.

15. VREG Stabilization

To stabilize the VREG voltage that is the power supply for the control circuit, connect a 0.1 μF or more capacitor between VREG and GND. The capacitor GND must be wired near the GND pin of IC as much as possible.

- Specifications of any and all SANYO products described or contained herein stipulate the performance, characteristics, and functions of the described products in the independent state, and are not guarantees of the performance, characteristics, and functions of the described products as mounted in the customer's products or equipment. To verify symptoms and states that cannot be evaluated in an independent device, the customer should always evaluate and test devices mounted in the customer's products or equipment.
- SANYO Electric Co., Ltd. strives to supply high-quality high-reliability products. However, any and all semiconductor products fail with some probability. It is possible that these probabilistic failures could give rise to accidents or events that could endanger human lives, that could give rise to smoke or fire, or that could cause damage to other property. When designing equipment, adopt safety measures so that these kinds of accidents or events cannot occur. Such measures include but are not limited to protective circuits and error prevention circuits for safe design, redundant design, and structural design.
- In the event that any or all SANYO products (including technical data, services) described or contained herein are controlled under any of applicable local export control laws and regulations, such products must not be exported without obtaining the export license from the authorities concerned in accordance with the above law.
- No part of this publication may be reproduced or transmitted in any form or by any means, electronic or mechanical, including photocopying and recording, or any information storage or retrieval system, or otherwise, without the prior written permission of SANYO Electric Co., Ltd.
- Any and all information described or contained herein are subject to change without notice due to product/technology improvement, etc. When designing equipment, refer to the "Delivery Specification" for the SANYO product that you intend to use.
- Information (including circuit diagrams and circuit parameters) herein is for example only; it is not guaranteed for volume production. SANYO believes information herein is accurate and reliable, but no guarantees are made or implied regarding its use or any infringements of intellectual property rights or other rights of third parties.

This catalog provides information as of June, 2002. Specifications and information herein are subject to change without notice.