

### Features

- **Ultra-Slim 1.6mm Max. Case Height**
- Glass Passivated Die Construction
- High Reliability
- Low Forward Voltage Drop
- High Surge Current Capability
- Designed for Surface Mount Application
- Plastic Material – UL Flammability 94V-0

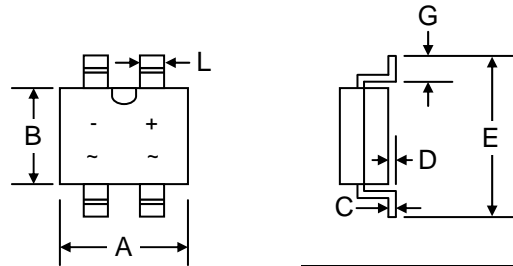

### Mechanical Data

- Case: MBL-S, Molded Plastic
- Terminals: Plated Leads Solderable per MIL-STD-202, Method 208
- Polarity: As Marked on Case
- Weight: 0.10 grams (approx.)
- Mounting Position: Any
- Marking: Type Number
- **Lead Free: For RoHS / Lead Free Version, Add “-LF” Suffix to Part Number, See Page 4**

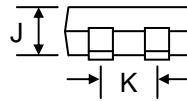

MBL-S		
Dim	Min	Max
A	4.50	5.10
B	3.60	4.60
C	0.10	0.35
D	—	0.20
E	6.40	7.20
G	0.70	1.10
J	1.30	1.60
K	2.20	2.60
L	0.56	0.84
All Dimensions in mm		

### Maximum Ratings and Electrical Characteristics @ $T_A=25^\circ\text{C}$ unless otherwise specified

Single Phase, half wave, 60Hz, resistive or inductive load.  
For capacitive load, derate current by 20%.

Characteristic	Symbol	LB1S	LB2S	LB4S	LB6S	LB8S	LB10S	Unit
Peak Repetitive Reverse Voltage	$V_{RRM}$							
Working Peak Reverse Voltage	$V_{RWM}$	100	200	400	600	800	1000	V
DC Blocking Voltage	$V_R$							
RMS Reverse Voltage	$V_{R(RMS)}$	70	140	280	420	560	700	V
Average Rectified Output Current (Note 1) @ $T_A = 40^\circ\text{C}$	$I_O$	0.8						A
Average Rectified Output Current (Note 2) @ $T_A = 40^\circ\text{C}$		0.5						
Non-Repetitive Peak Forward Surge Current 8.3ms Single Half Sine-Wave Superimposed on Rated Load (JEDEC Method)	$I_{FSM}$	35						A
Forward Voltage per diode @ $I_F = 0.4\text{A}$ @ $I_F = 0.8\text{A}$	$V_{FM}$	1.0 1.1						V
Peak Reverse Current @ $T_A = 25^\circ\text{C}$ At Rated DC Blocking Voltage @ $T_A = 125^\circ\text{C}$	$I_{RM}$	5.0 500						$\mu\text{A}$
Typical Junction Capacitance per diode (Note 3)	$C_J$	13						pF
Thermal Resistance Junction to Ambient (Note 2)	$R_{JA}$	134						$^\circ\text{C/W}$
Thermal Resistance Junction to Ambient (Note 1)	$R_{JA}$	76						
Thermal Resistance Junction to Lead (Note 2)	$R_{JL}$	20						
Operating and Storage Temperature Range	$T_J, T_{STG}$	-55 to +150						$^\circ\text{C}$

Note: 1. Mounted on aluminum substrate PCB with 1.3 x 1.3mm pad areas.  
2. Mounted on glass epoxy PCB with 1.3 x 1.3mm pad areas.  
3. Measured at 1.0 MHz and applied reverse voltage of 4.0V D.C.

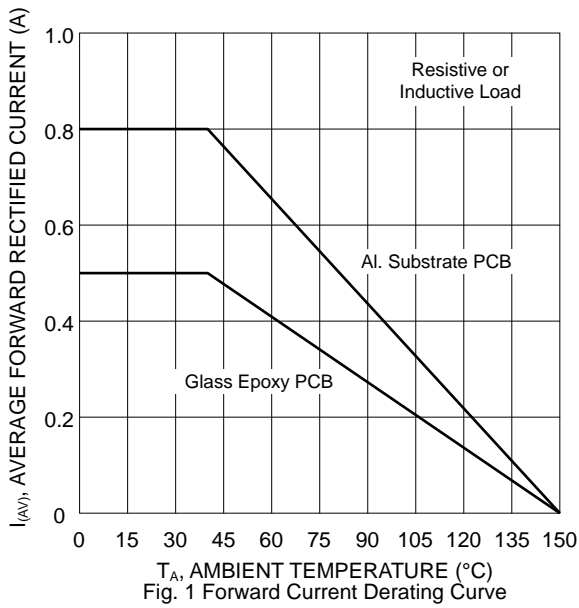

Fig. 1 Forward Current Derating Curve

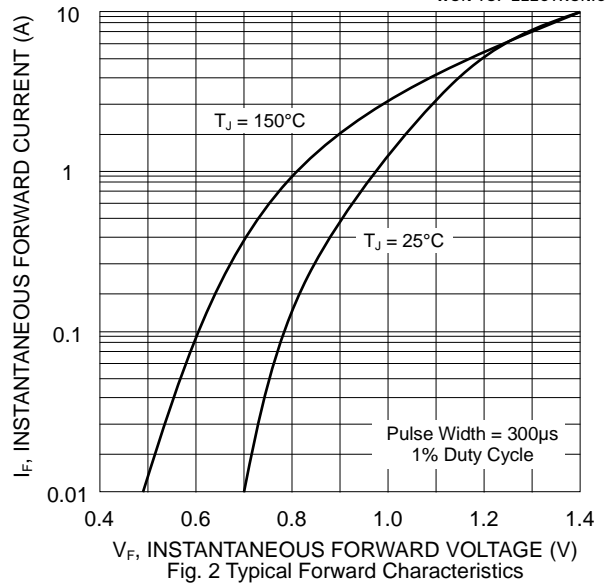

Fig. 2 Typical Forward Characteristics

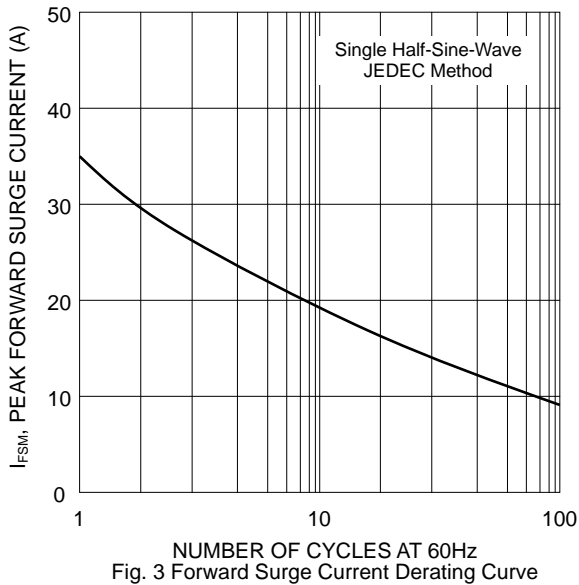

Fig. 3 Forward Surge Current Derating Curve

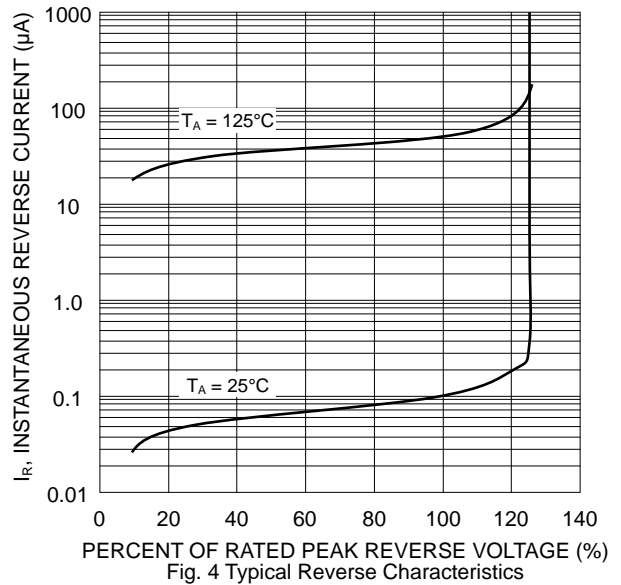

Fig. 4 Typical Reverse Characteristics

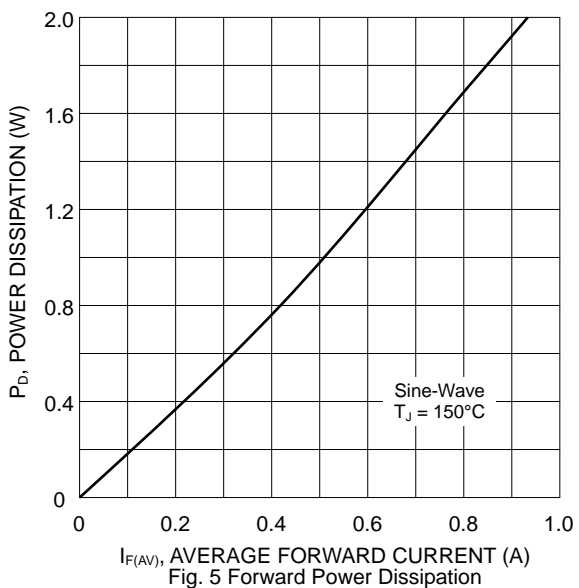

Fig. 5 Forward Power Dissipation

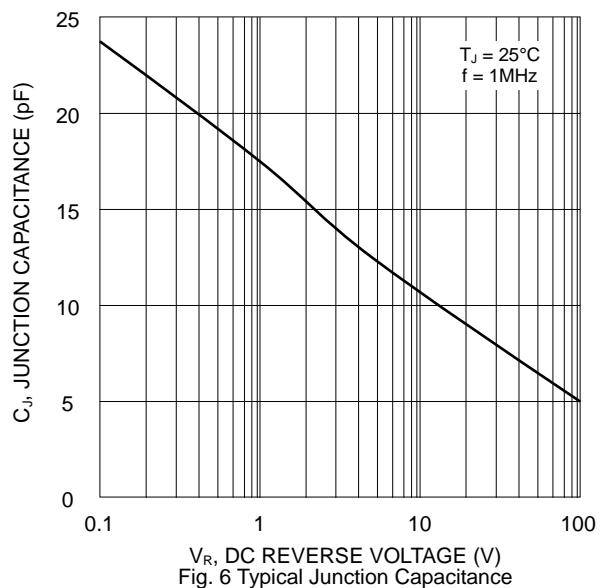
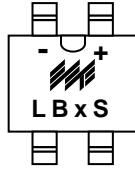

Fig. 6 Typical Junction Capacitance

## MARKING INFORMATION



LBxS = Device Number  
 x = 1, 2, 4, 6, 8 or 10  
 Polarity = As Marked on Body

## RECOMMENDED FOOTPRINT

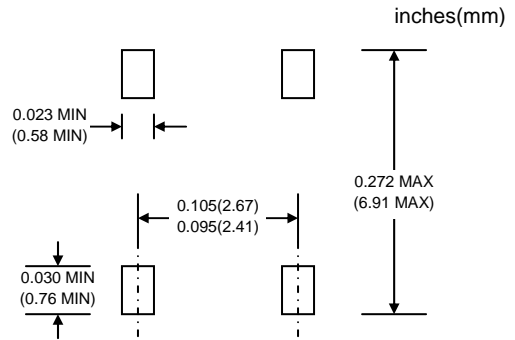

## PACKAGING INFORMATION

### TAPE & REEL

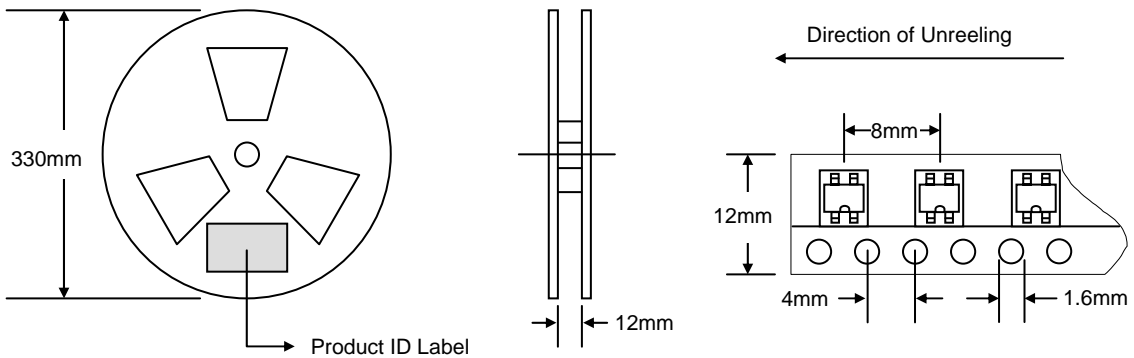

Reel Diameter (mm)	Quantity (PCS)	Inner Box Size L x W x H (mm)	Quantity (PCS)	Carton Size L x W x H (mm)	Quantity (PCS)	Approx. Gross Weight (KG)
330	4,000	340 x 337 x 45	8,000	370 x 370 x 420	64,000	14.0

**Note:** 1. Paper reel, white or gray color.  
 2. Components are packed in accordance with EIA standard 481-1 and 481-2.

## ORDERING INFORMATION

Product No.	Package Type	Shipping Quantity
LB1S-T3	MBL-S	4000/Tape & Reel
LB2S-T3	MBL-S	4000/Tape & Reel
LB4S-T3	MBL-S	4000/Tape & Reel
LB6S-T3	MBL-S	4000/Tape & Reel
LB8S-T3	MBL-S	4000/Tape & Reel
LB10S-T3	MBL-S	4000/Tape & Reel

1. Shipping quantity given is for minimum packing quantity only. For minimum order quantity, please consult the Sales Department.
2. **To order RoHS / Lead Free version (with Lead Free finish), add "-LF" suffix to part number above. For example, LB1S-T3-LF.**

WON-TOP ELECTRONICS and  are registered trademarks of Won-Top Electronics Co., Ltd (WTE). WTE has checked all information carefully and believes it to be correct and accurate. However, WTE cannot assume any responsibility for inaccuracies. Furthermore, this information does not give the purchaser of semiconductor devices any license under patent rights to manufacturer. WTE reserves the right to change any or all information herein without further notice.

**WARNING: DO NOT USE IN LIFE SUPPORT EQUIPMENT.** WTE power semiconductor products are not authorized for use as critical components in life support devices or systems without the express written approval.

**Won-Top Electronics Co., Ltd.**  
No. 44 Yu Kang North 3rd Road,  
Chine Chen Dist., Kaohsiung 806, Taiwan  
**Phone:** 886-7-822-5408 or 886-7-822-5410  
**Fax:** 886-7-822-5417  
**Email:** sales@wontop.com  
**Internet:** http://www.wontop.com

*We power your everyday.*