

Specifications

Parameter	Unit	Minimum	Typical	Maximum	
Center Frequency	MHz	69.95	70	70.05	
Insertion Loss	dB	-	25.5	27	
3 dB Bandwidth	MHz	10.75	10.8	10.85	
Selectivity	$f_0 \pm 5.8\text{MHz}$	dBc	35	41	-
	$f_0 \pm 6.0\text{MHz}$	dBc	45	52	-
	$f_0 \pm 6.4\text{MHz}$	dBc	50	54	-
	$f_0 \pm 10.4\text{MHz}$	dBc	50	55	-
Passband Variation	dB	-	0.5	1	
Ultimate Rejection	dB	50	55	-	
Absolute delay	usec	-	3.75	4	
Substrate Material		YZ-LiNbO ₃			
Ambient Temperature	°C	25			
Package Size		DIP3512 (35.2x12.7x5.2mm ³)			

Notes:

1. All specifications are based on the test circuit shown
2. In production, devices will be tested at room temperature to a guardbanded specification to ensure electrical compliance over temperature
3. Electrical margin has been built into the design to account for the variations due to temperature drift and manufacturing tolerances
4. This is the optimum impedance in order to achieve the performance shown

Matching Configuration

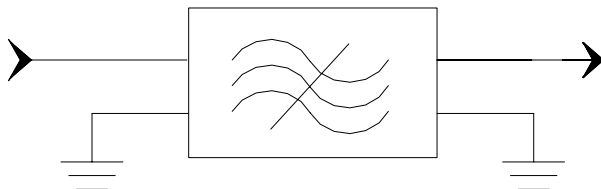

Source/Load Impedance=50 ohm

Notes - Component values may change depending on board layout.

	SIPAT Co., Ltd. (CETC No. 26 Research Institute) Nanping Huayuan Road No. 14 Chongqing, China, 400060	Part Number	LBN07089	
		Rev. Date	2004-12-18	
		Rev.	1.0	Page

Package Dimension

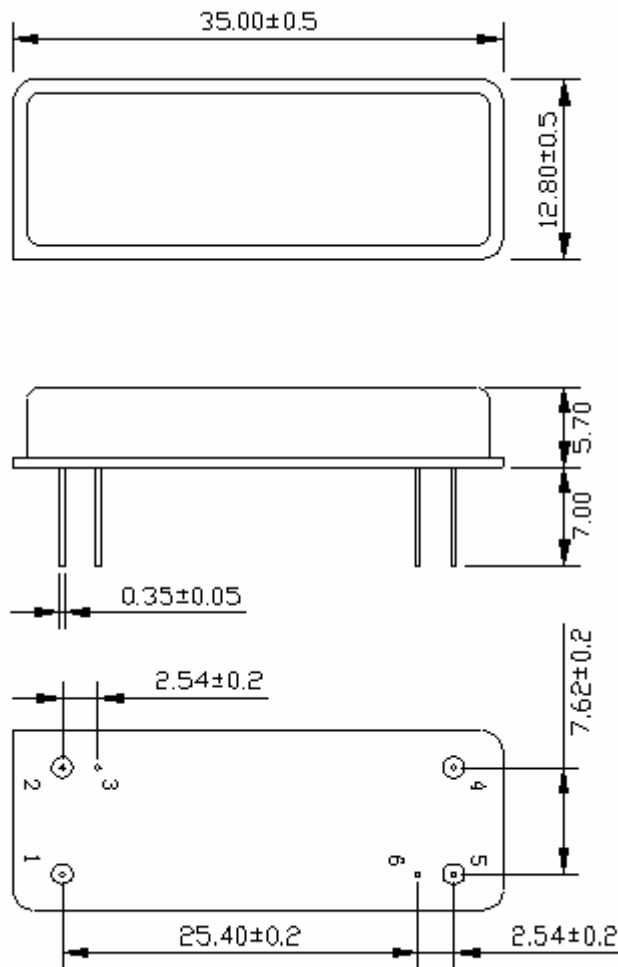

SIPAT Co., Ltd.
(CETC No. 26 Research Institute)
Nanping Huayuan Road No. 14
Chongqing, China, 400060

Part Number	LBN07089	
Rev. Date	2004-12-18	
Rev.	1.0	Page 2/3

Typical Performance

Frequency Respond

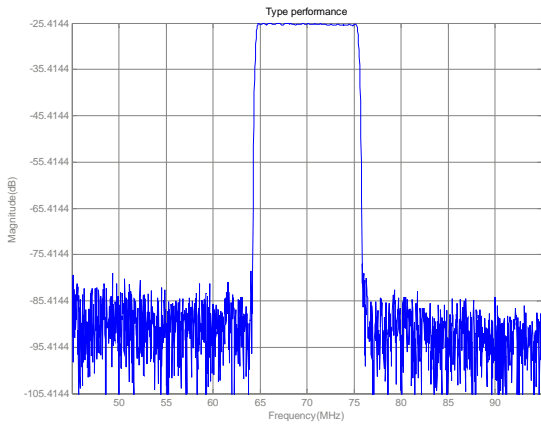

Passband Respond

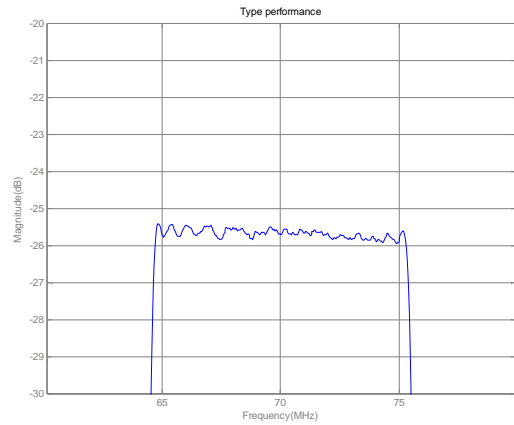

Wideband Respond

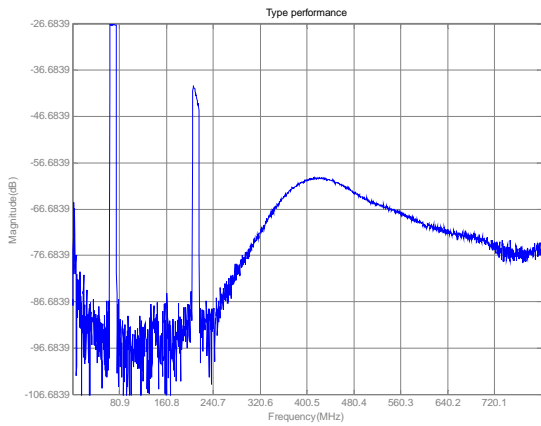

Phase Linearity (f0±5.37MHz)

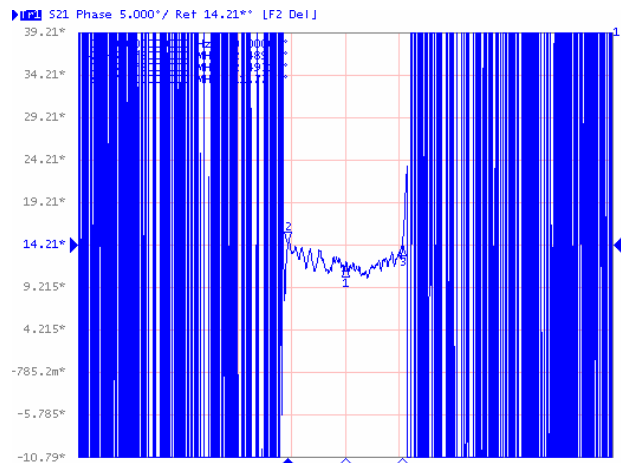

Smith Chart S11

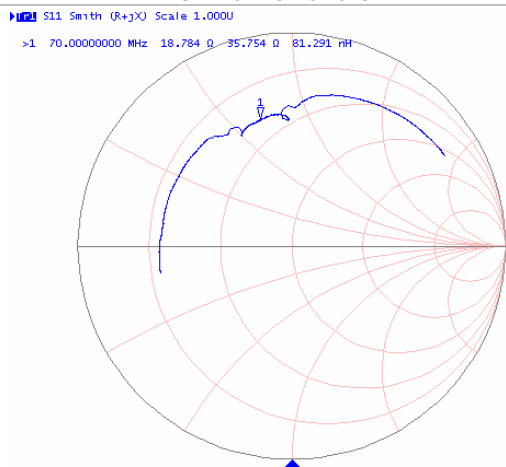

Smith Chart S22

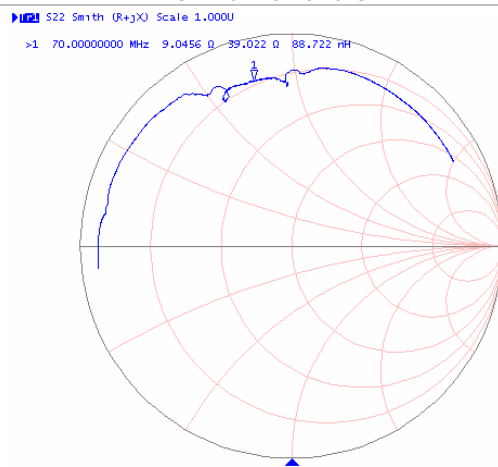

SIPAT Co., Ltd.
(CETC No. 26 Research Institute)
Nanping Huayuan Road No. 14
Chongqing, China, 400060

Part Number	LBN07089	
Rev. Date	2004-12-18	
Rev.	1.0	Page 3/3